



43242

# Disney Snow White and the Seven Dwarfs



Booklet available in English on  
Heft in deutscher Sprache erhältlich auf  
Livret disponible en français sur  
Libretto disponibile in italiano su  
Folleto disponible en español en  
如需中文版手册, 请访问





[LEGO.com/sustainable-packaging](https://LEGO.com/sustainable-packaging)



FR  
**DONNEZ  
OU  
RECYCLEZ**



ASSOCIATION

OU



MAGASIN

OU



DÉCHÈTERIE

Adresses sur [quefairedemesdechets.fr](https://quefairedemesdechets.fr)





# BUILDER



Apple and the Apple logo are trademarks of Apple Inc., registered in the U.S. and other countries and regions. App Store is a service mark of Apple Inc. Google Play and the Google Play logo are trademarks of Google LLC. Tencent and the Tencent logo are trademarks of Tencent Inc.

LEGO.com/devicecheck



LEGO® Builder

## Once upon a time

A princess named Snow White captivated audiences worldwide in the first-ever full-length animated Disney film.







Get ready for a LEGO® building experience that takes you on a magical journey through Snow White's world. Make a wish at the wishing well, make yourself at home in the iconic, cosy cottage and break the Evil Queen's spell to give Snow White her happily ever after.

**“It was a magical experience to explore the beautiful details of the movie and capture them in LEGO® form.”**

– Ryan Baird-Van Woerkom, LEGO® Designer

## An icon in the making

Walt Disney believed so strongly in his vision of a full-length animated film and worked tirelessly to bring *Snow White and the Seven Dwarfs* to the big screen. To recreate lifelike movements and facial expressions, animators used models, dancers and actors as references.







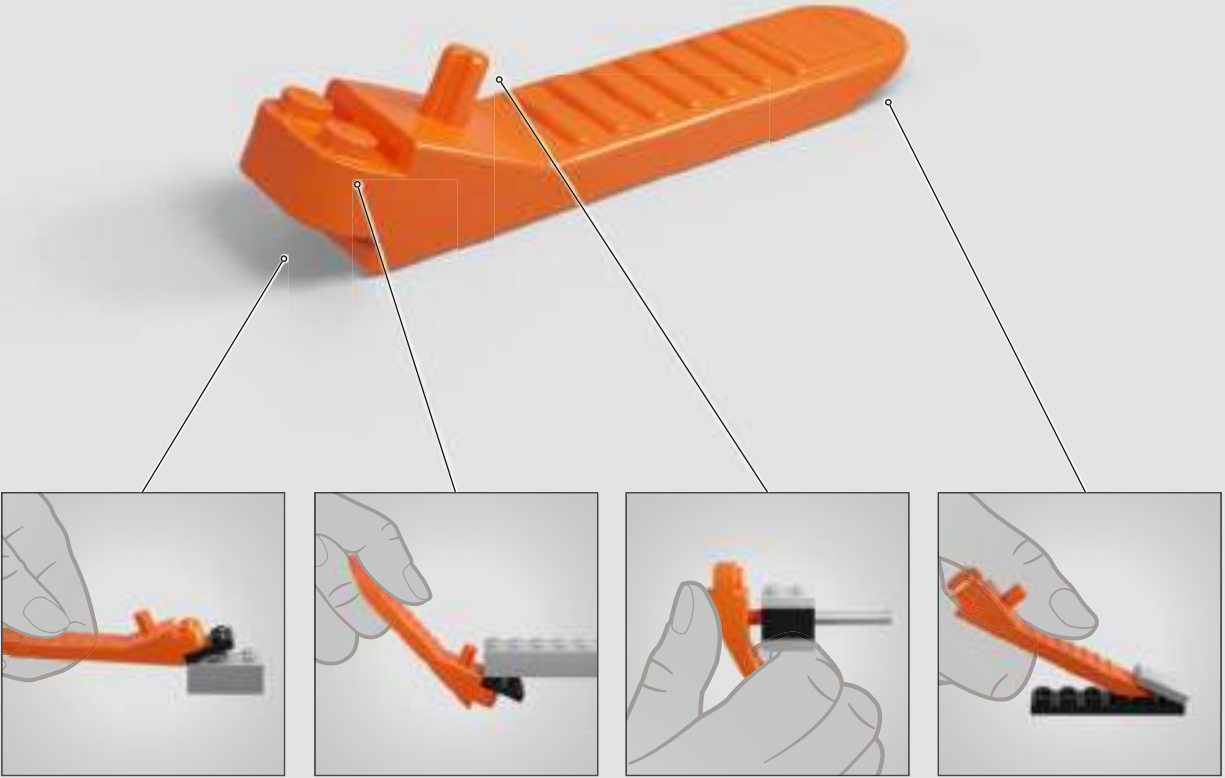





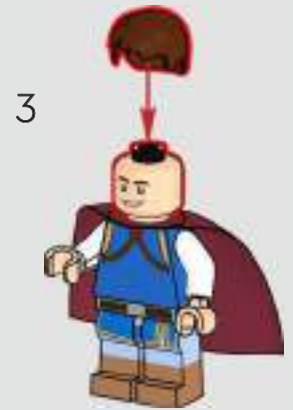
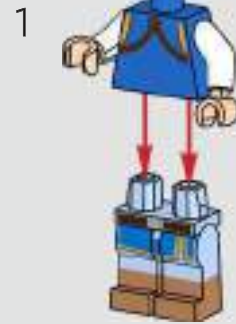
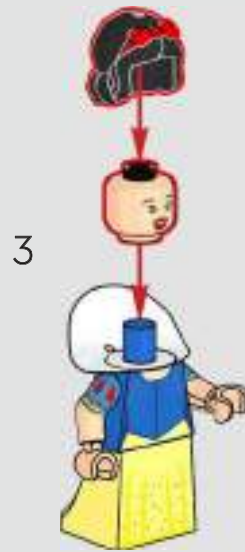





1



2

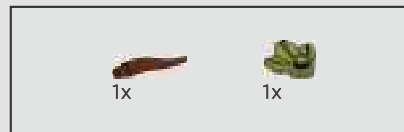
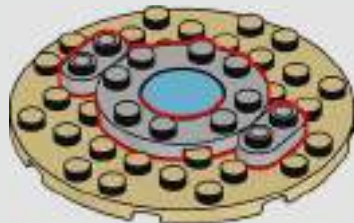

3

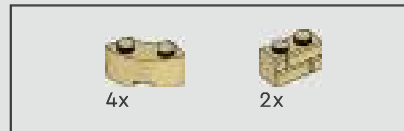

4

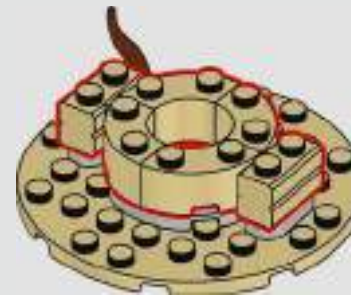



2x

5

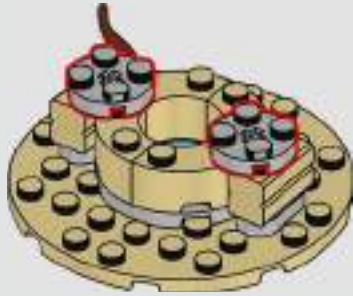

2x

6

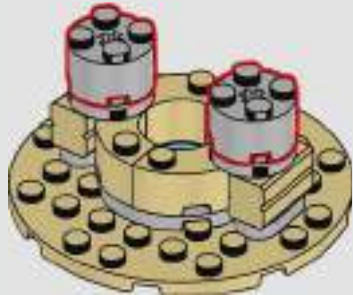

2x

7

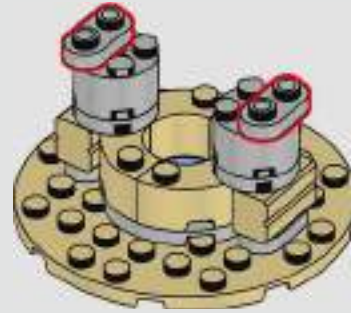

2x

8

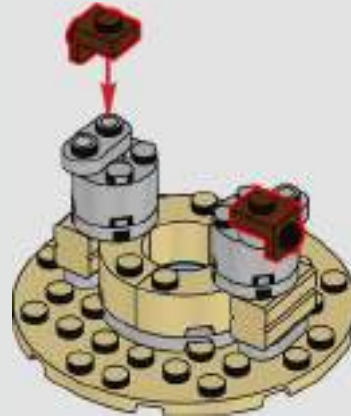

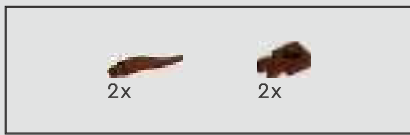

9

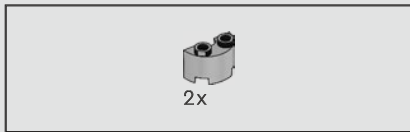
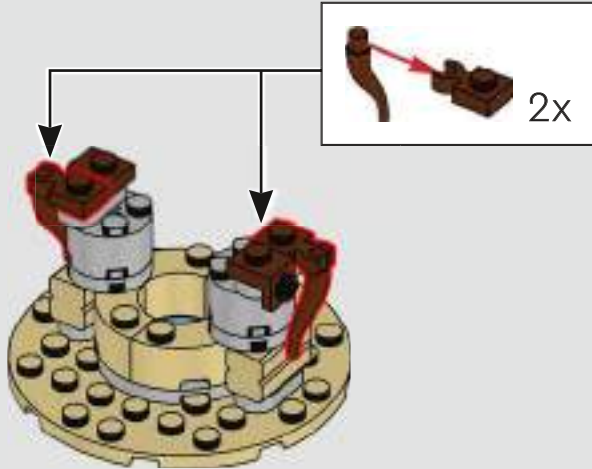

10

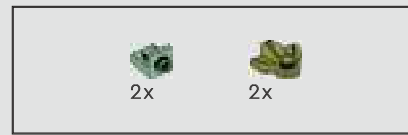

11

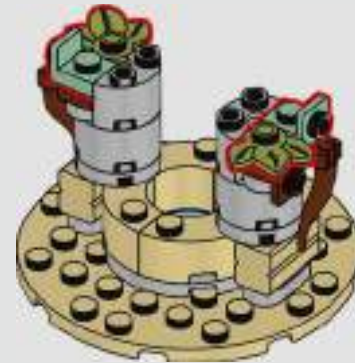

12

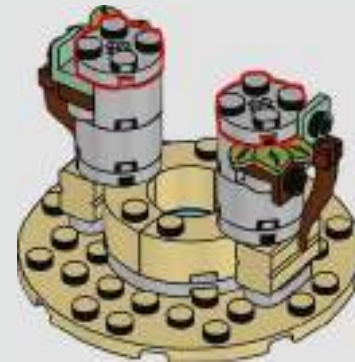





4x

13



1x



1x

14

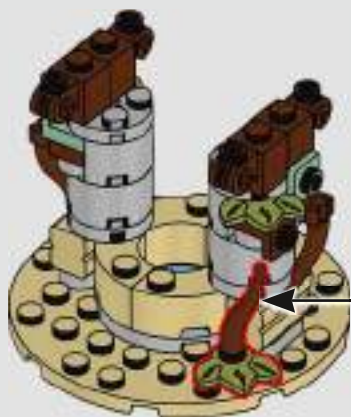

2x



2x

15

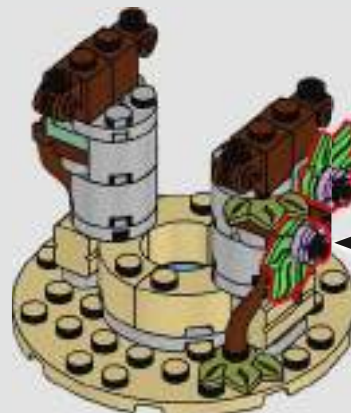

2x



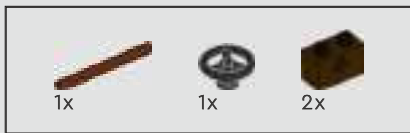

16

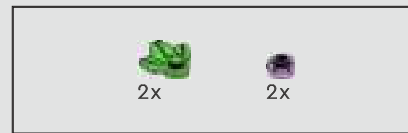
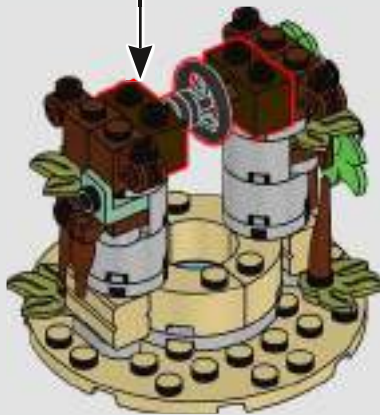
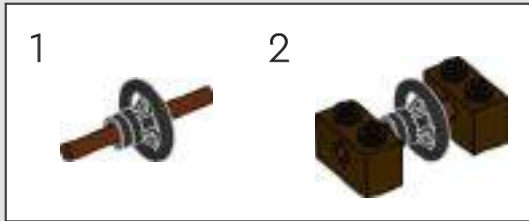

17

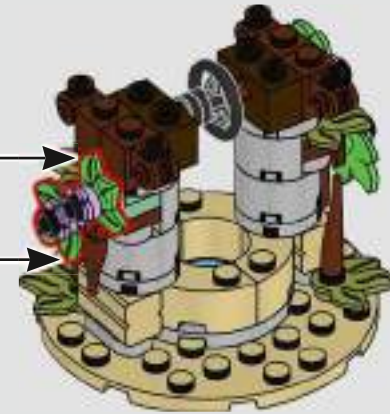

18





4x

19



1x



1x



2x

20





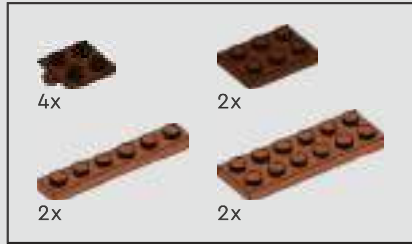
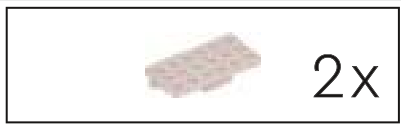

21

1



2



3

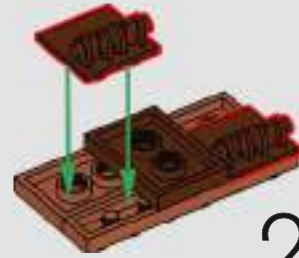

2x



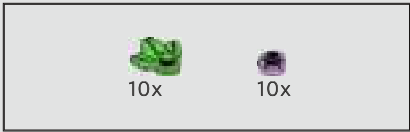

22

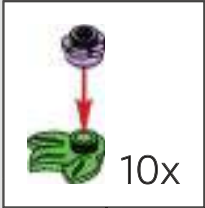

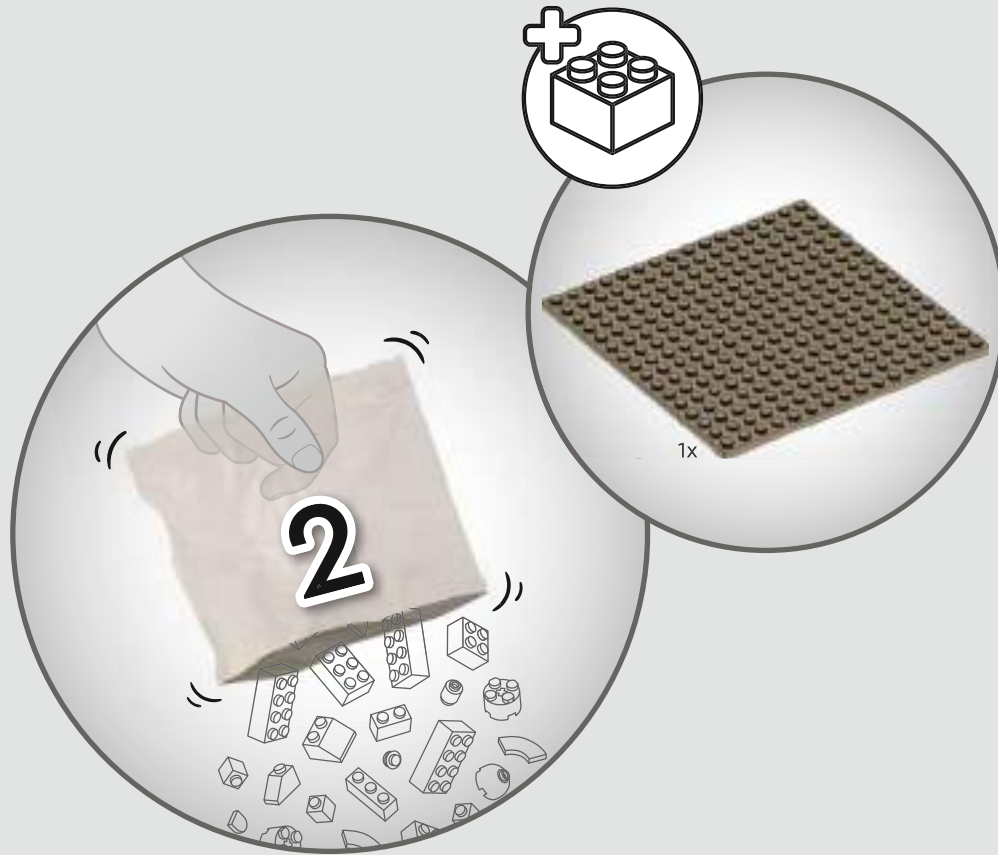





1

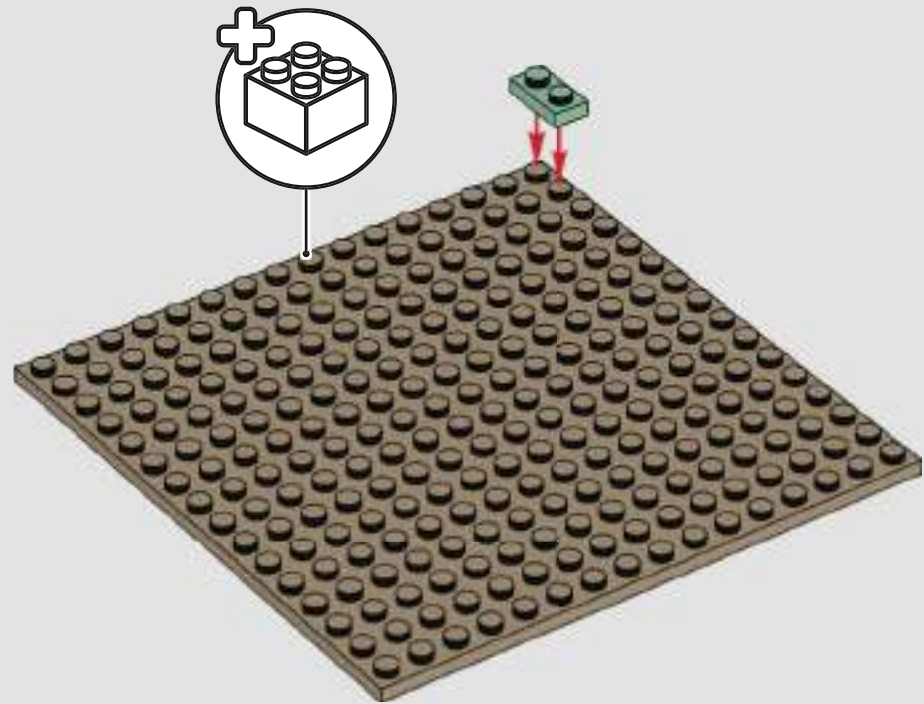

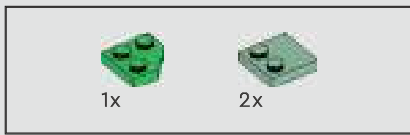

2

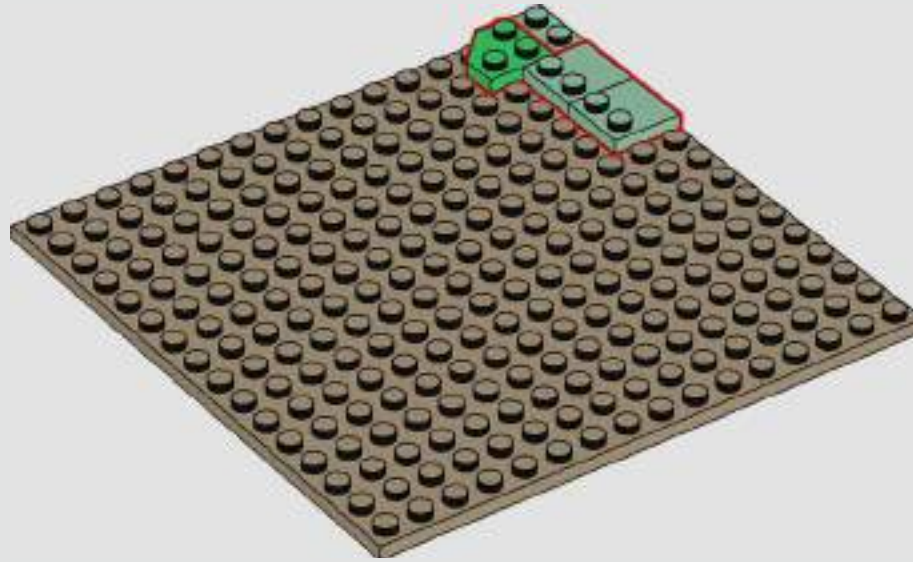

3

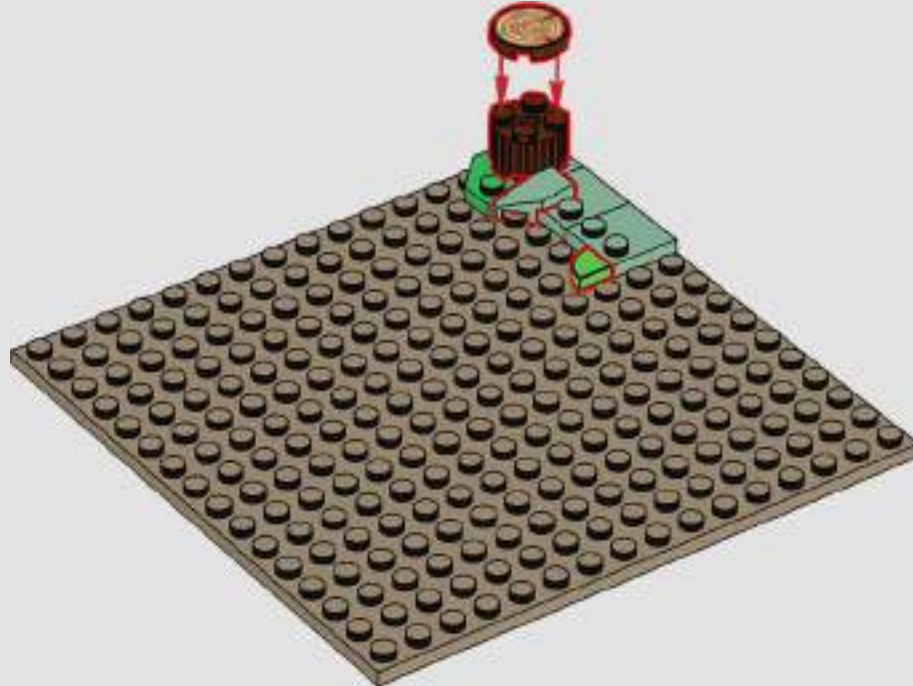

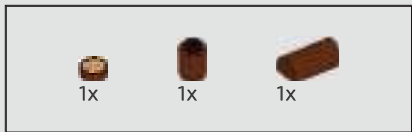

4

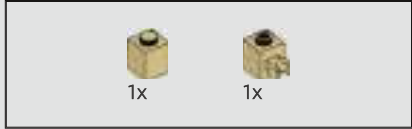
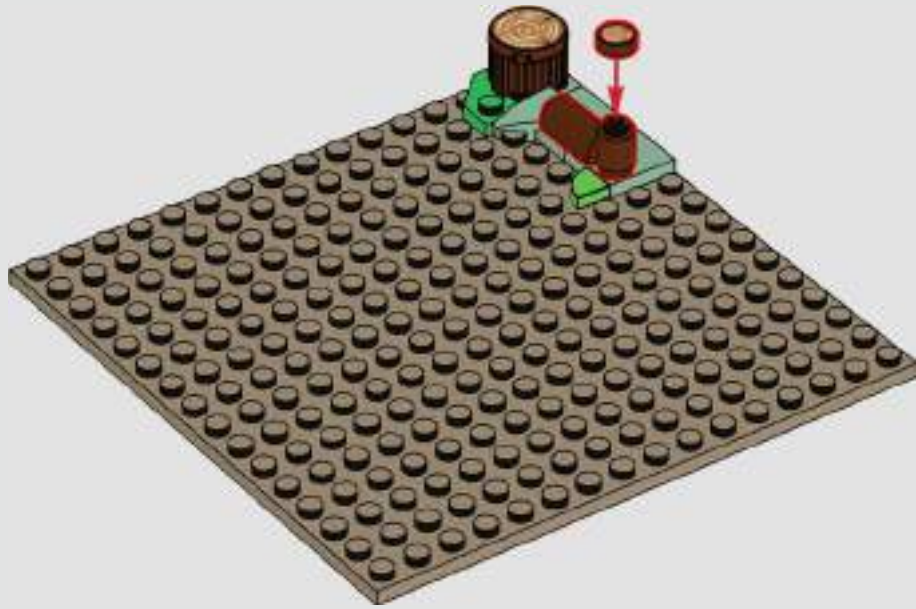

5







6

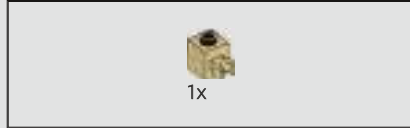
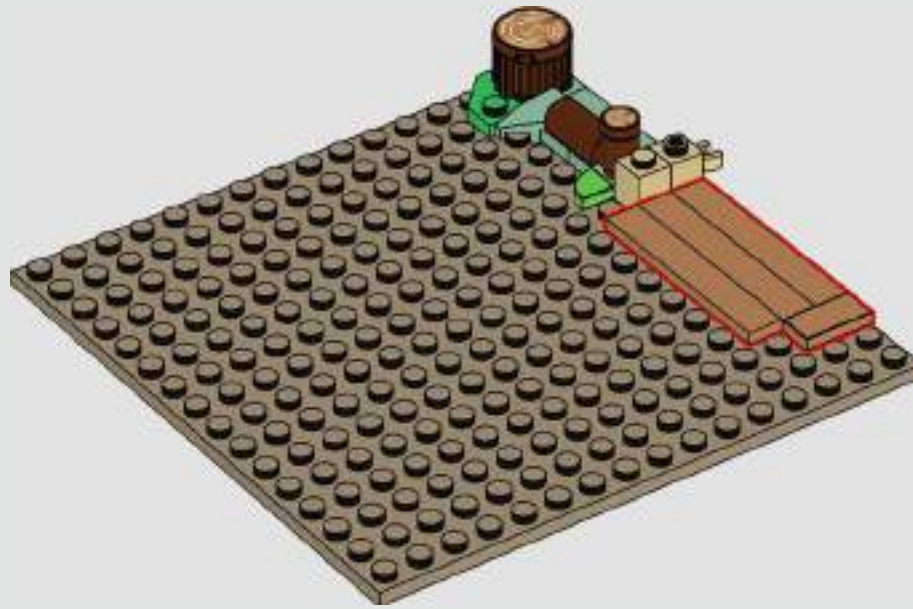

7





8

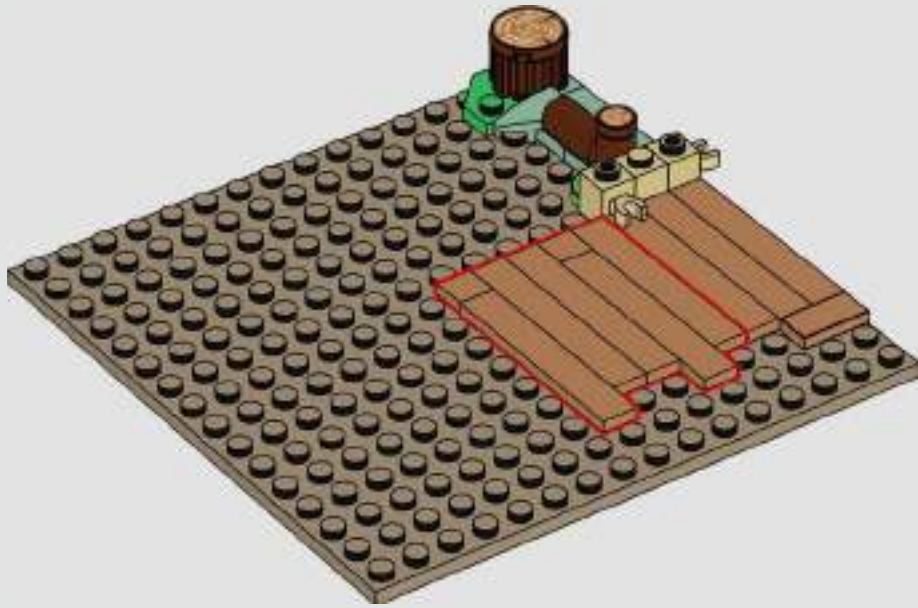

9

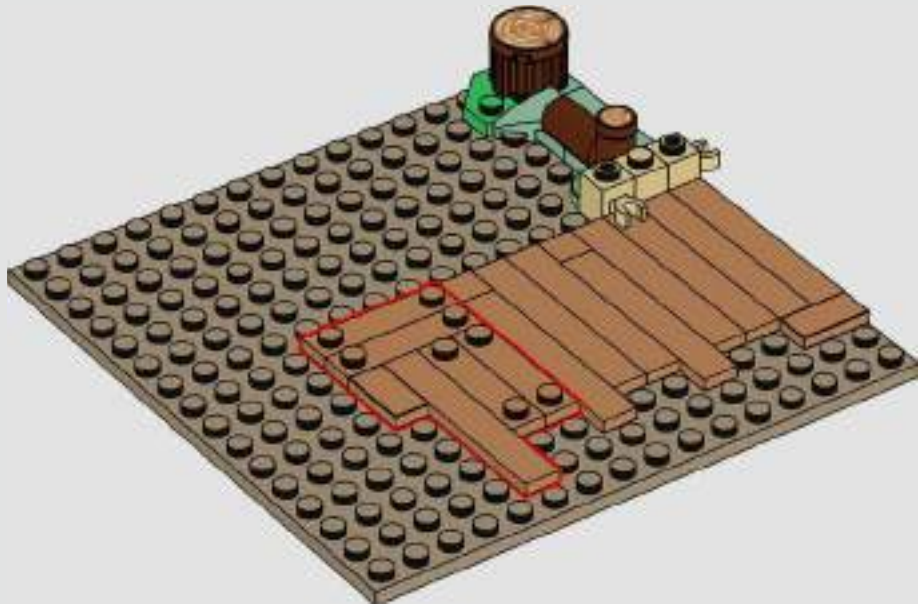



10



11

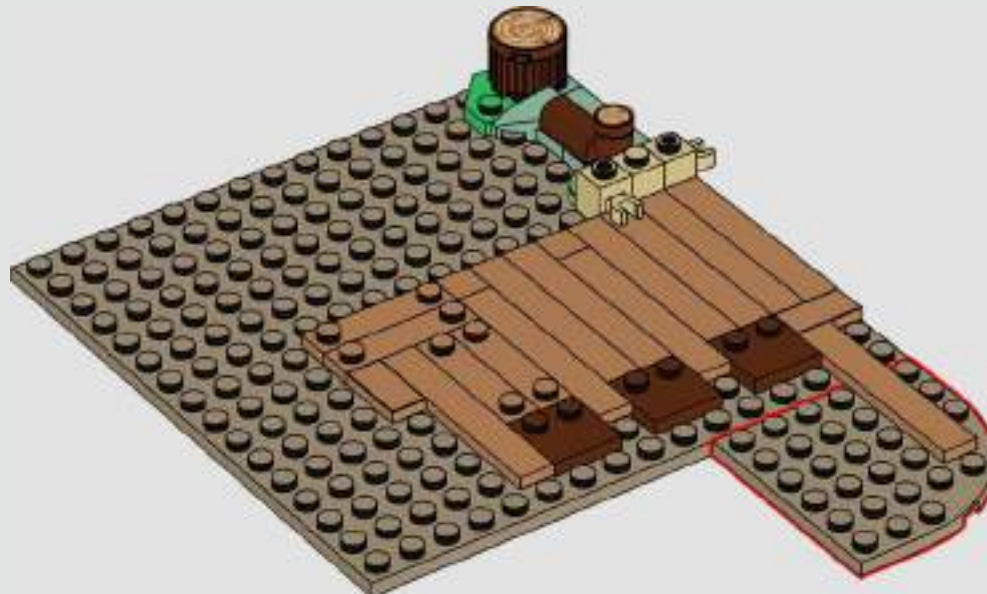





12

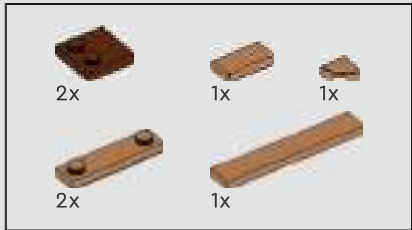
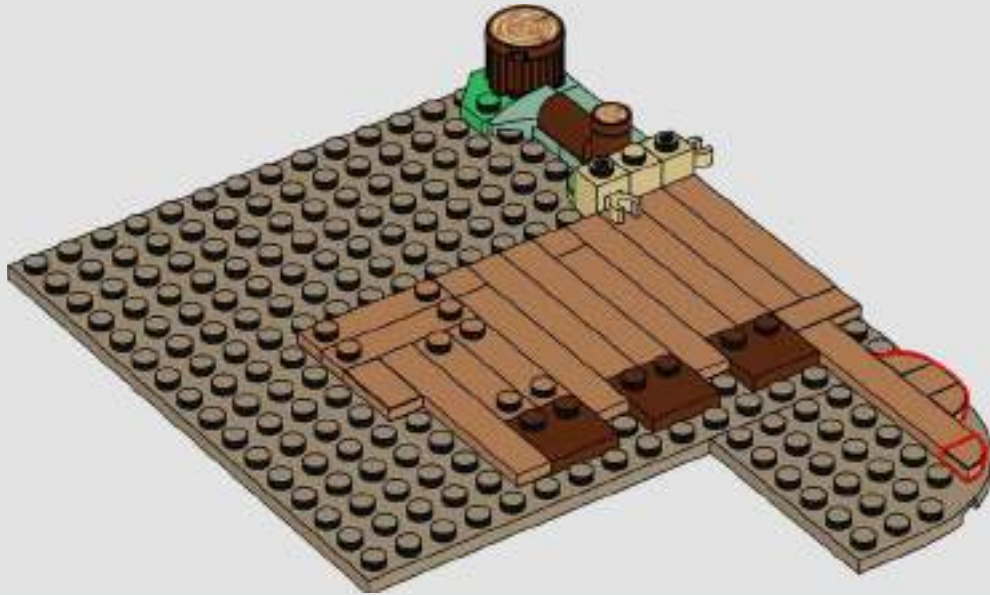

13

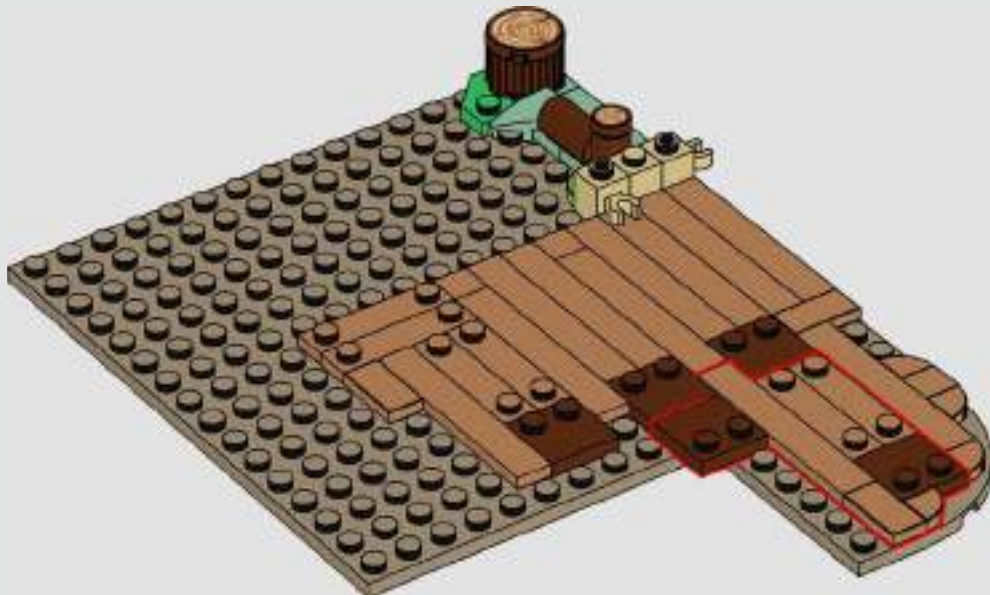





14

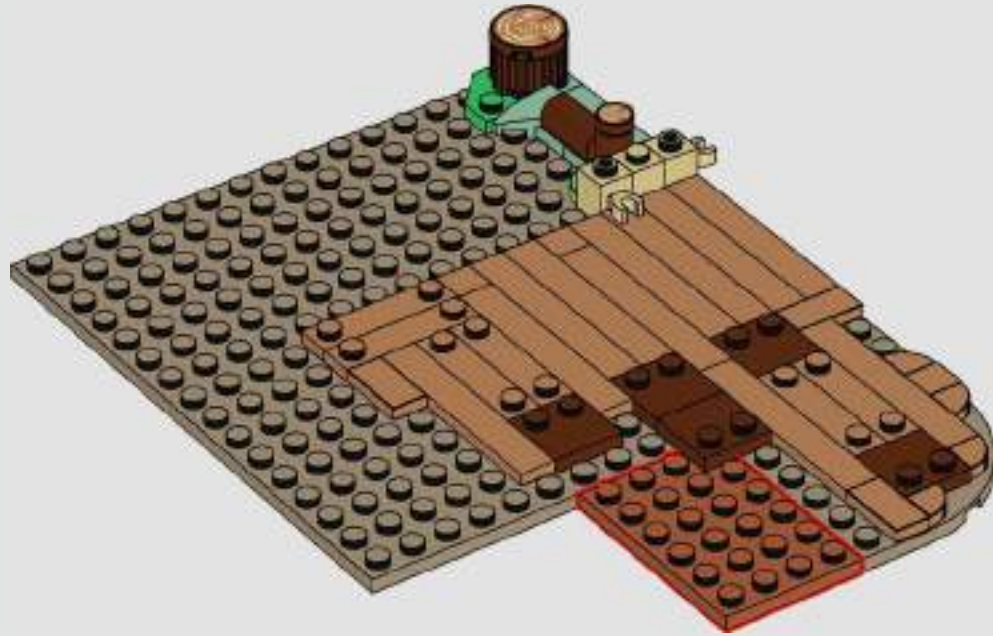

15

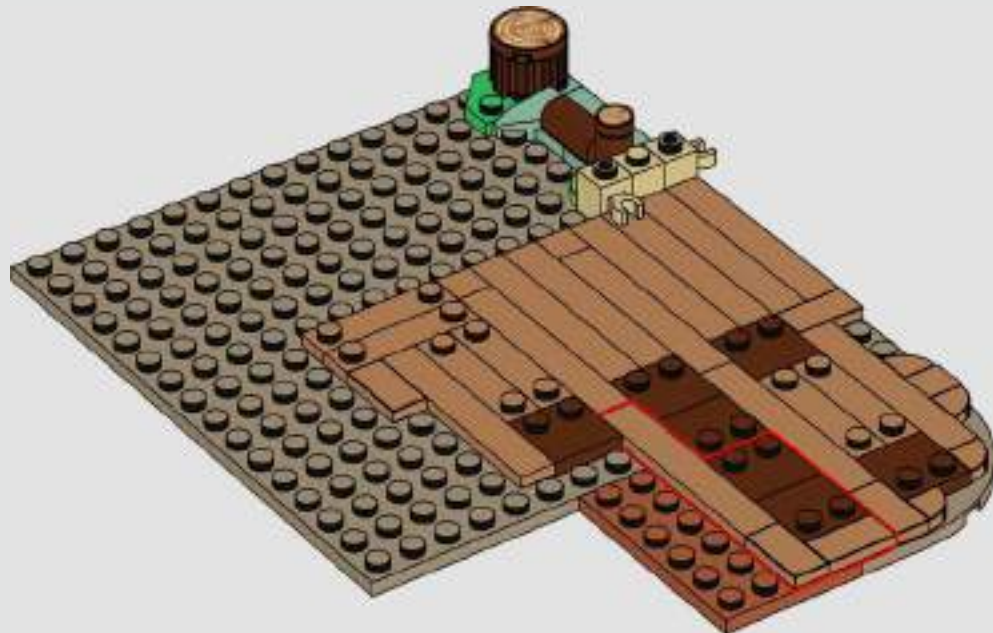



16

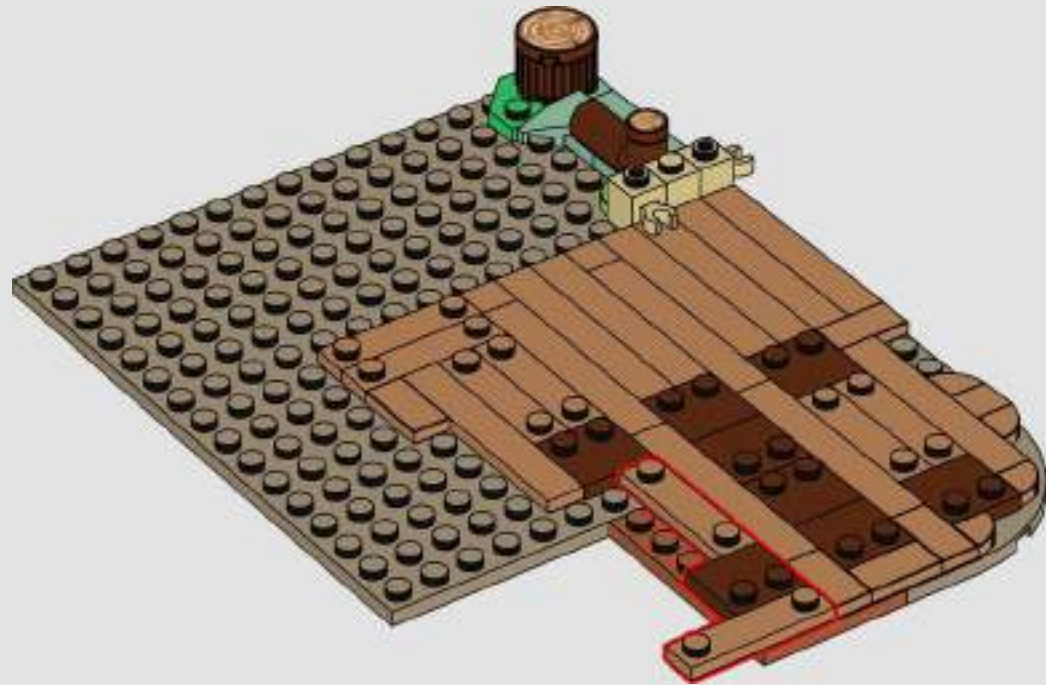

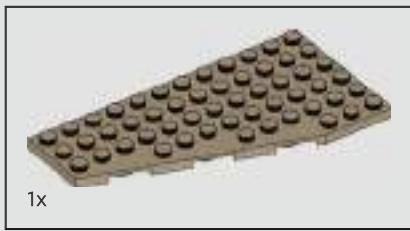

17

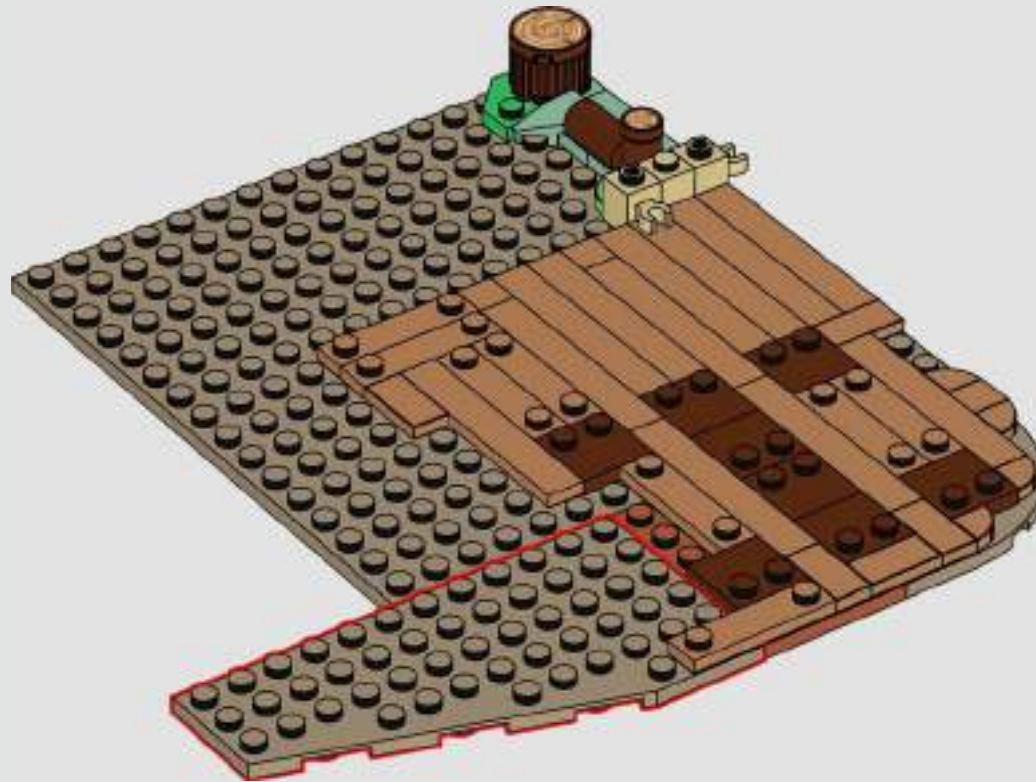

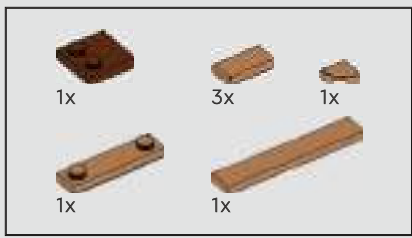

18

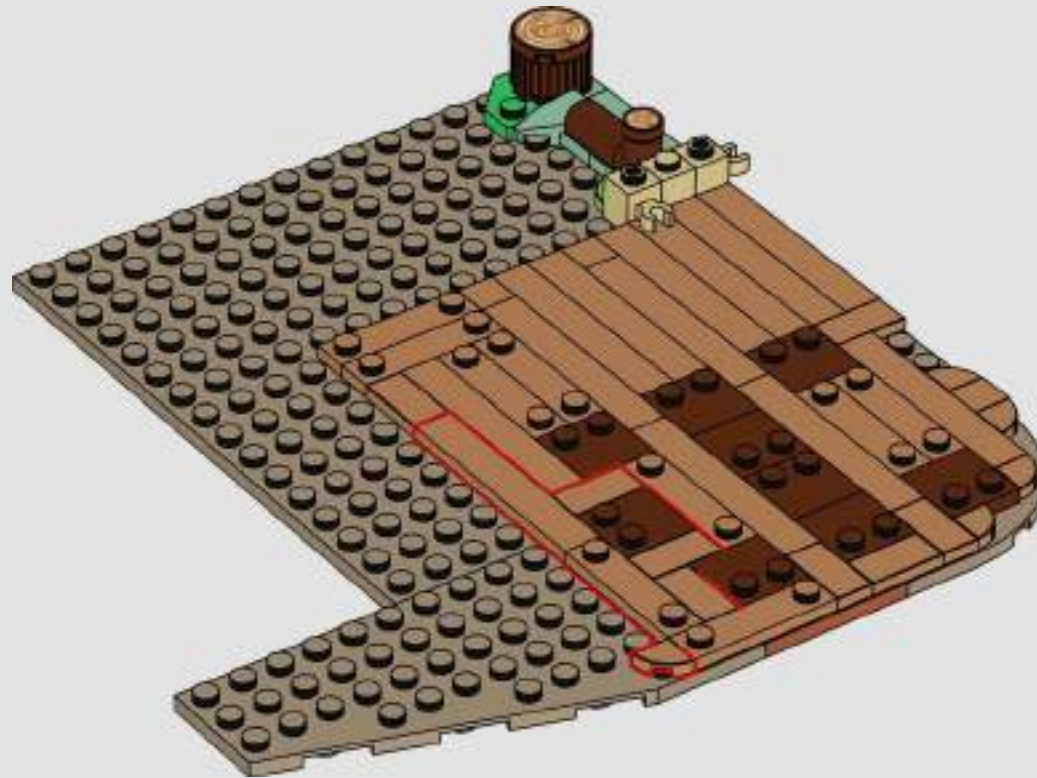



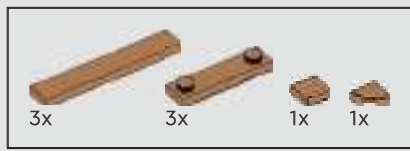

19

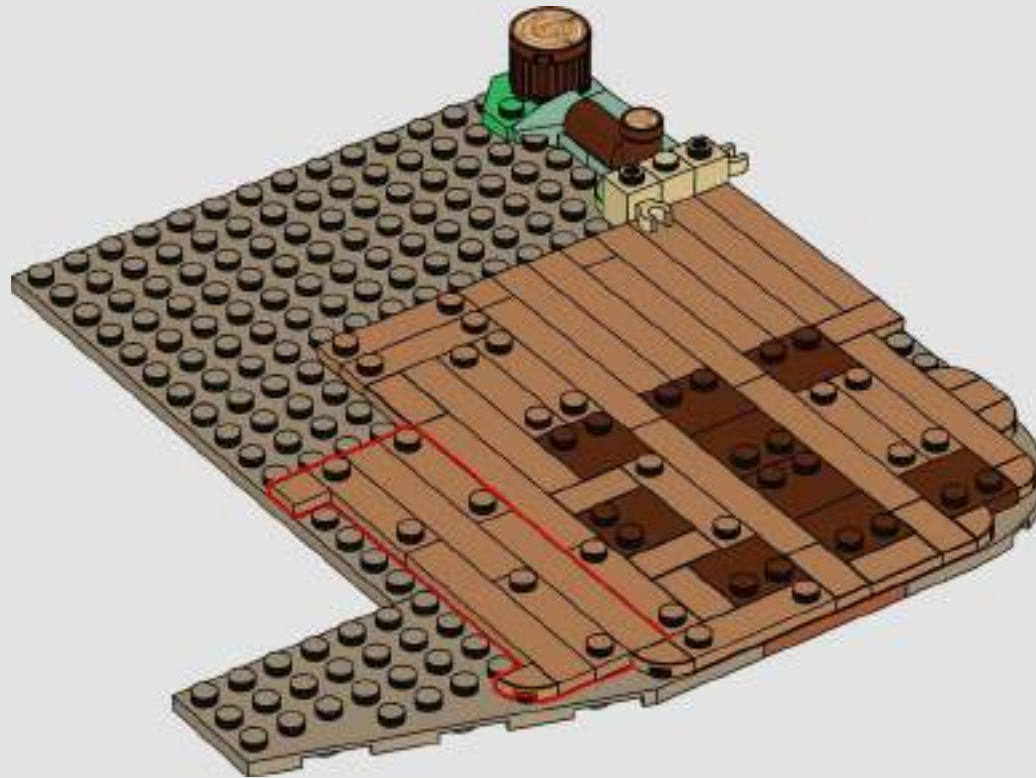

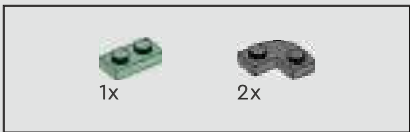

20

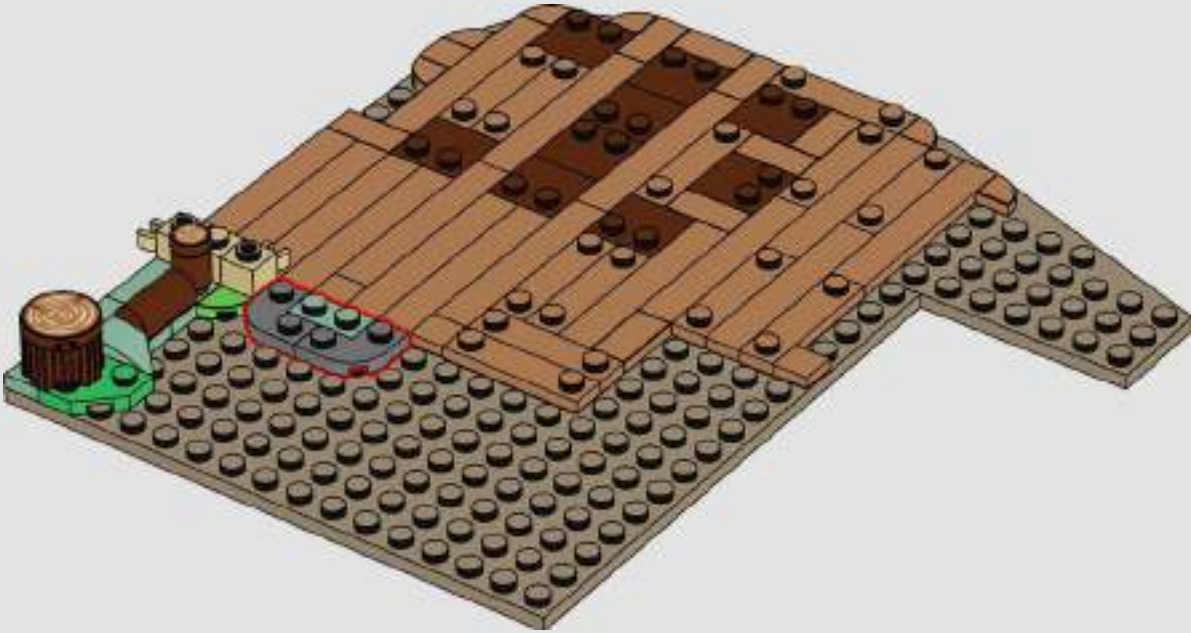

21

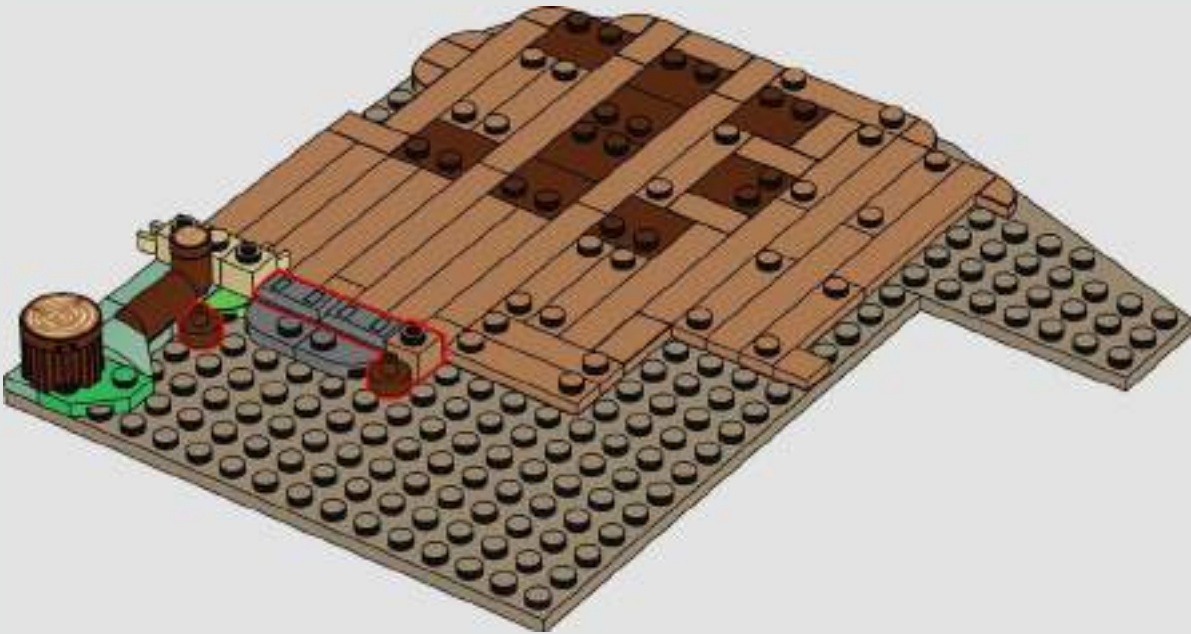



22

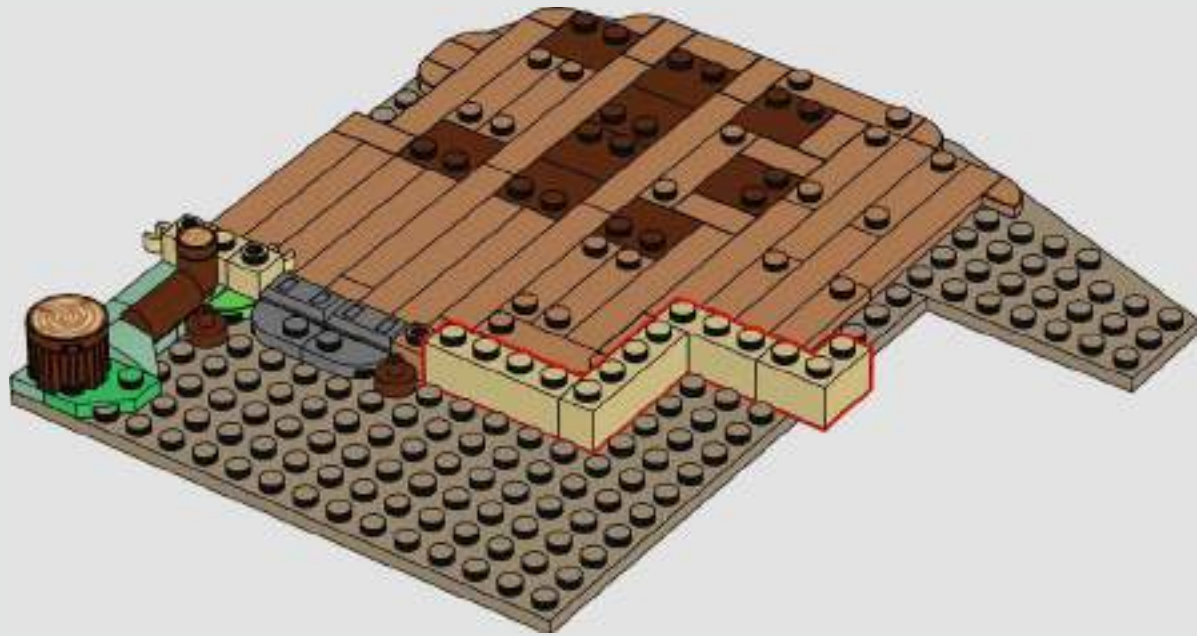

23

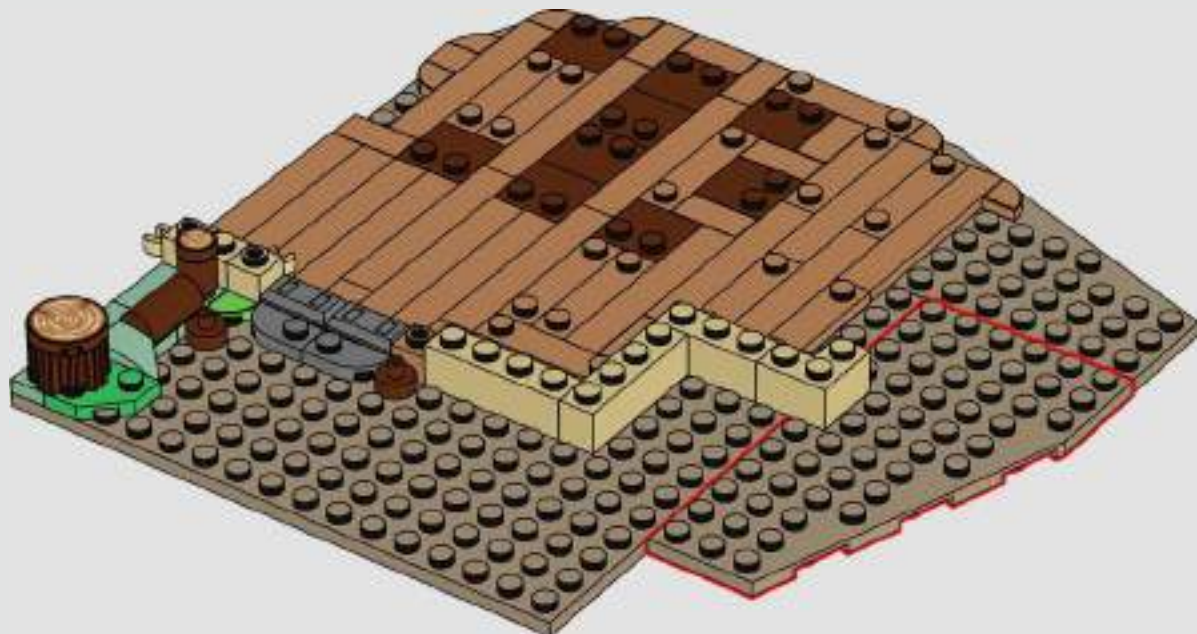



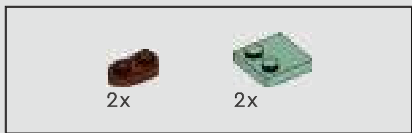

24

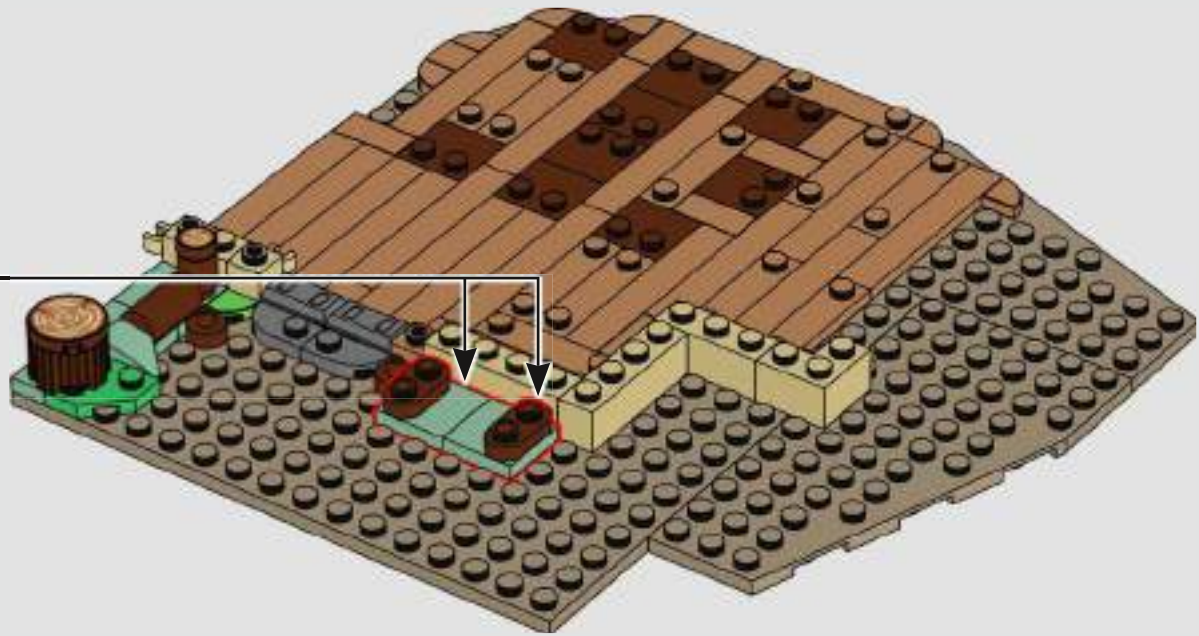
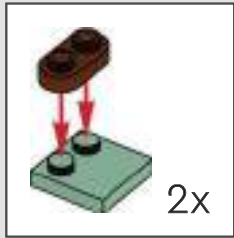

25

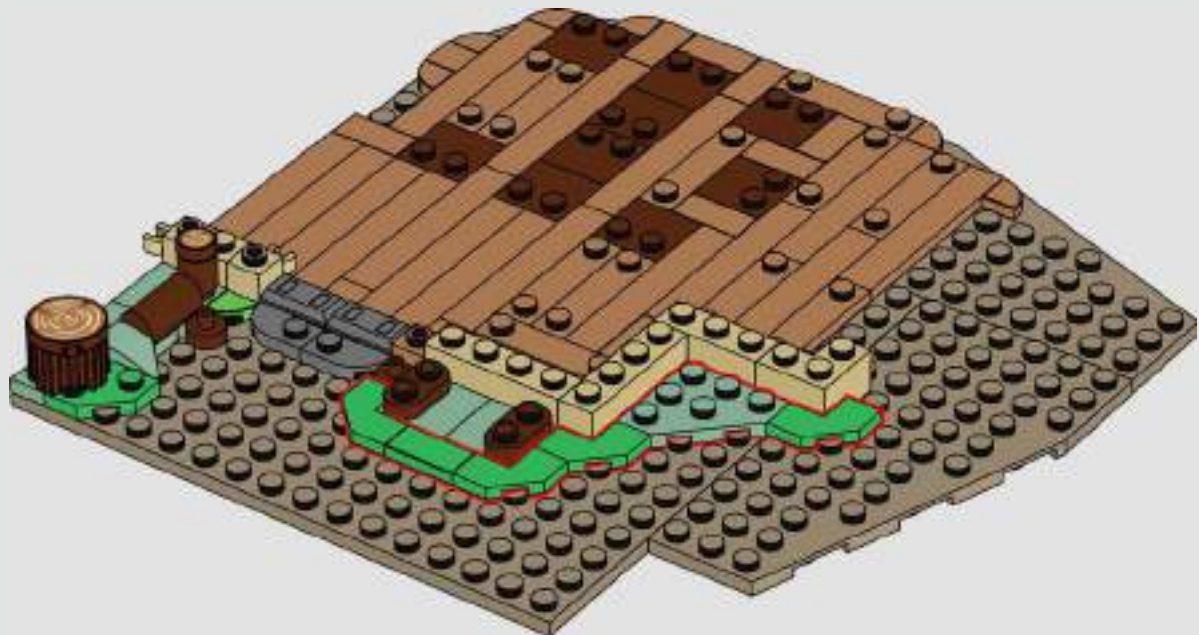





26

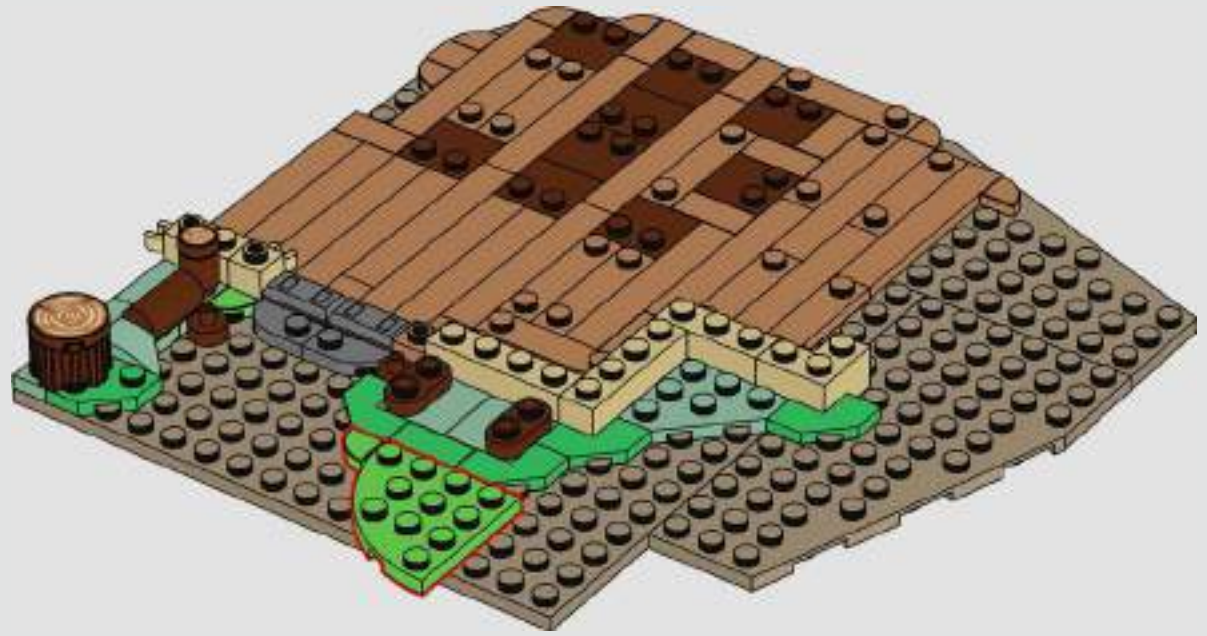

27

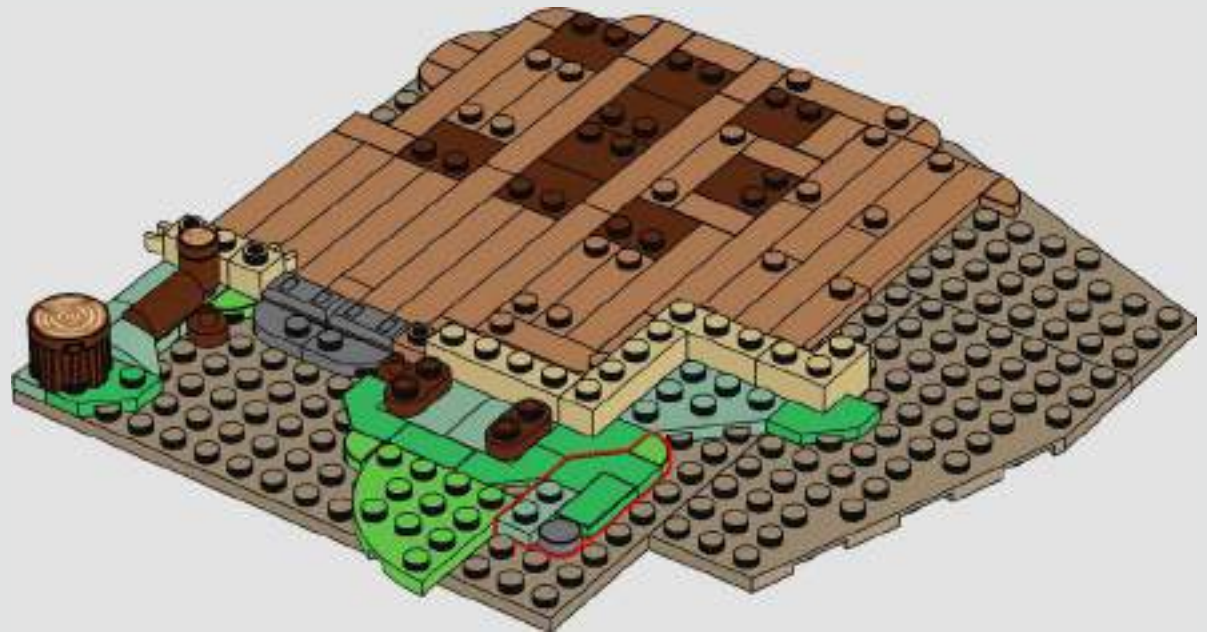



28

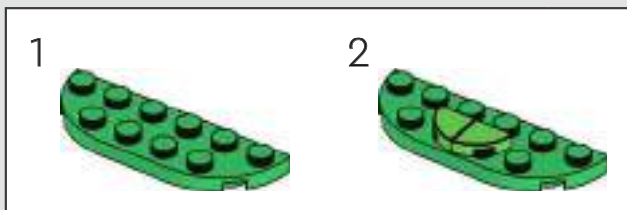
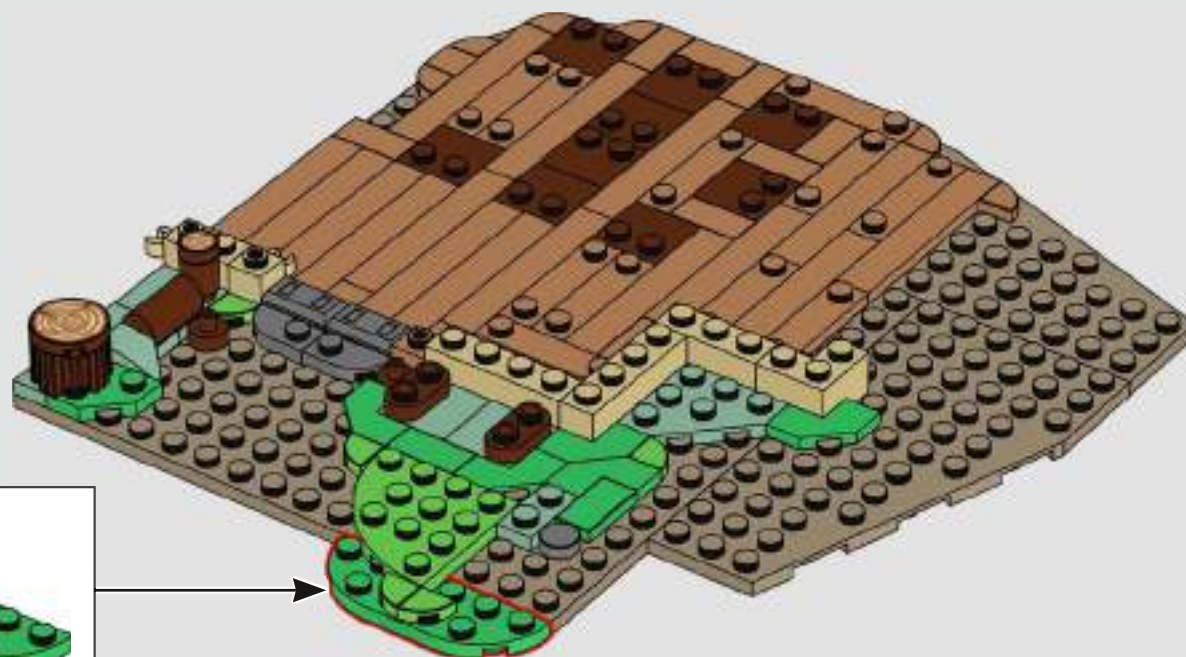



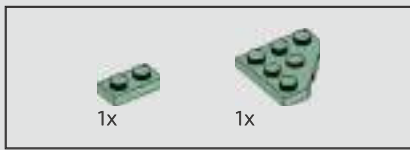

29

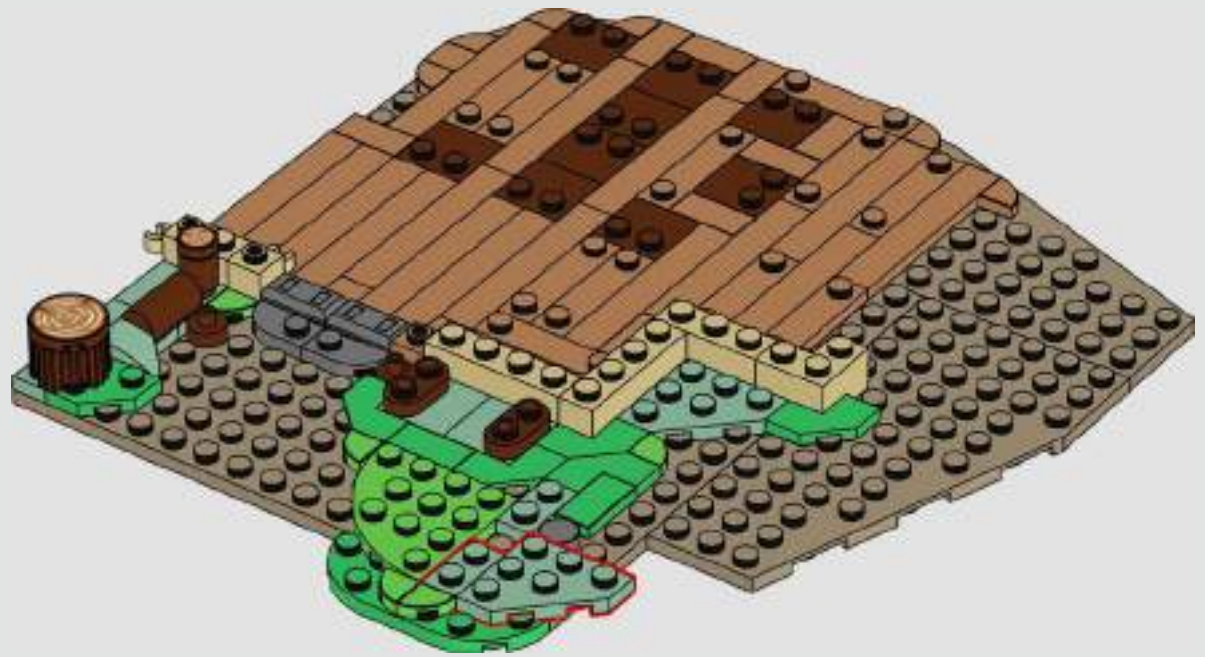

30

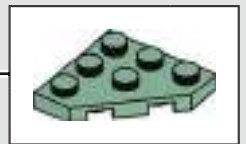
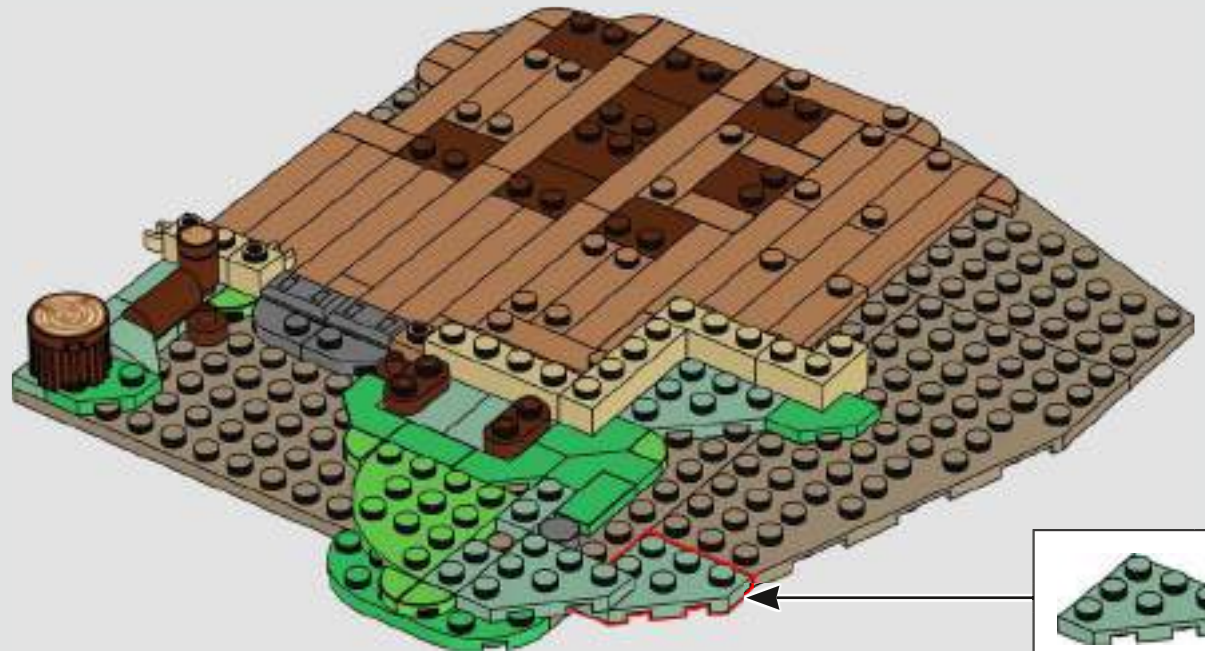



31

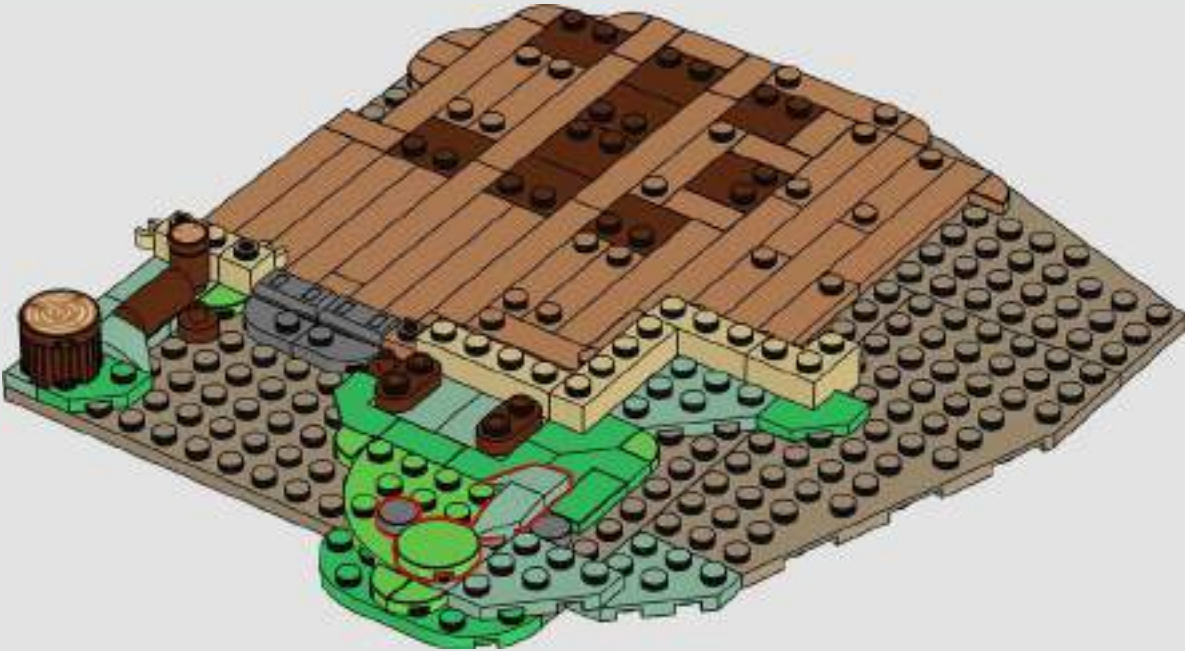

32

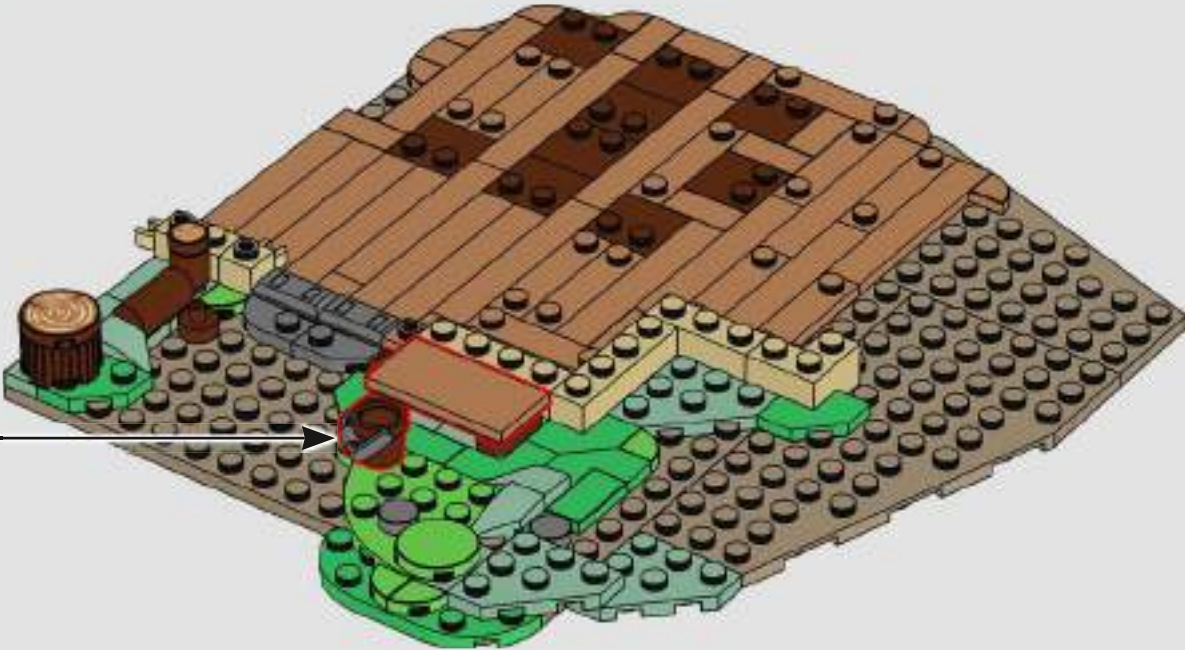



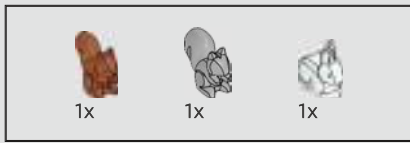

33

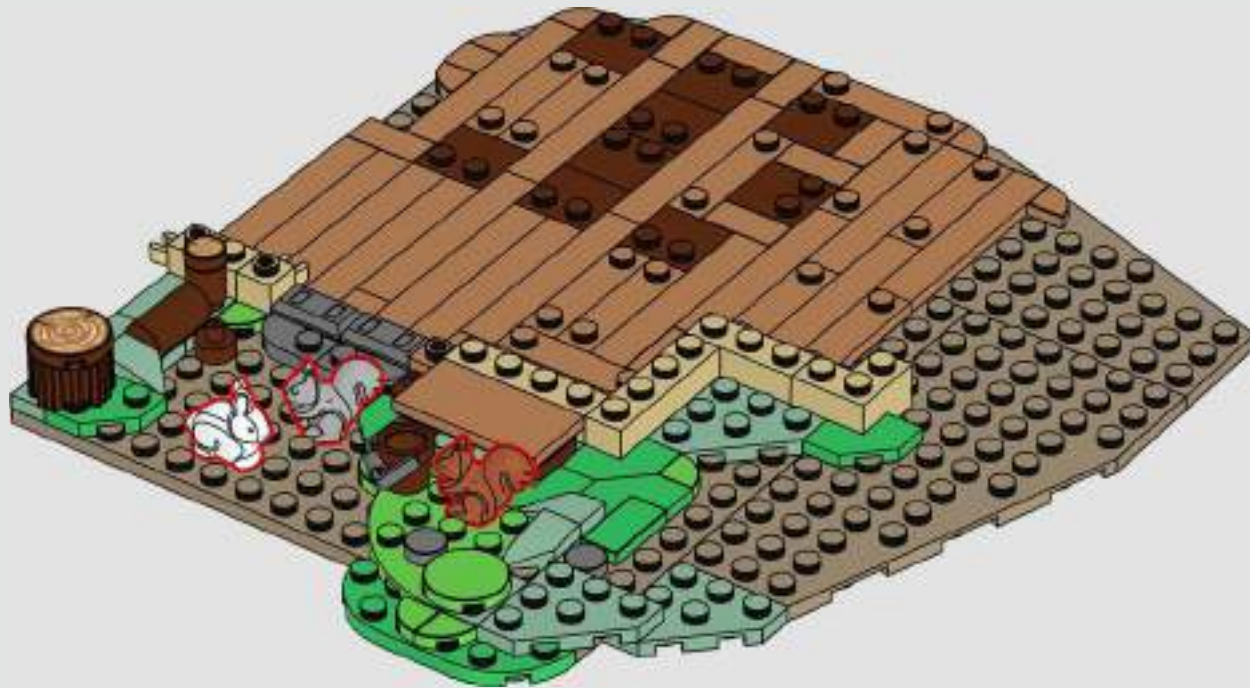



34



35



36

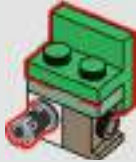

37





38

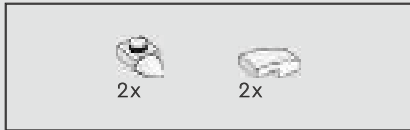
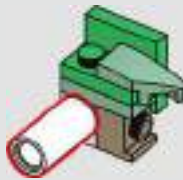

39

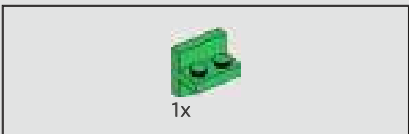
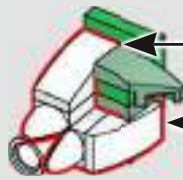
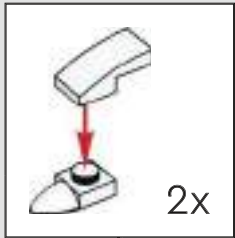

40



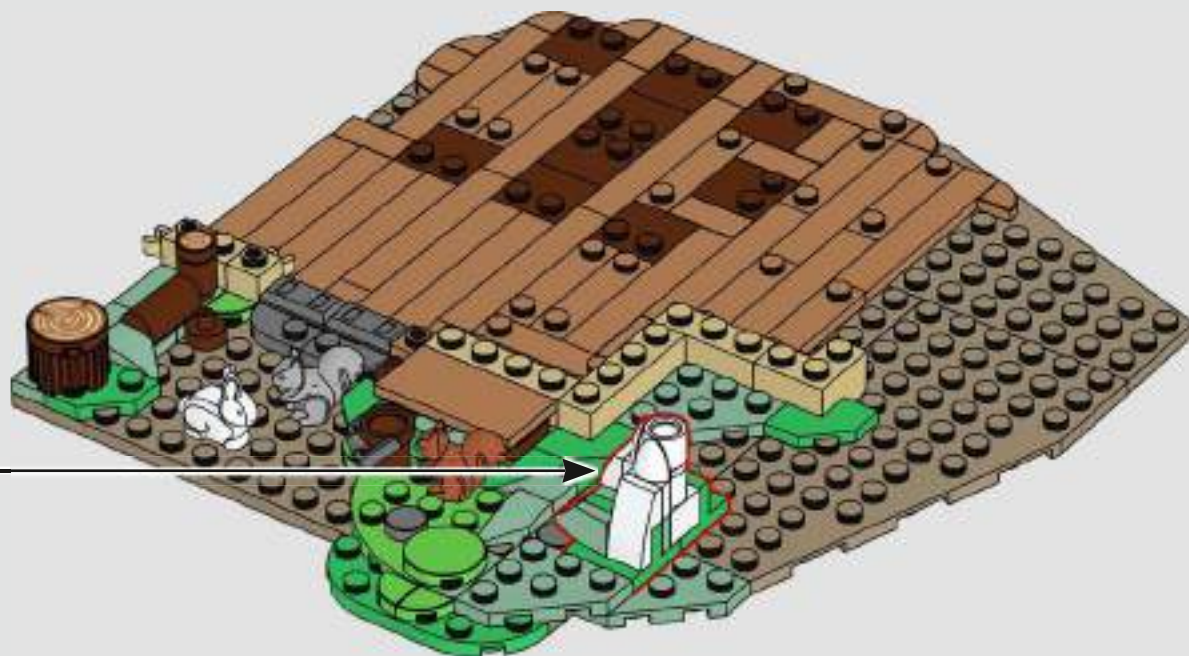



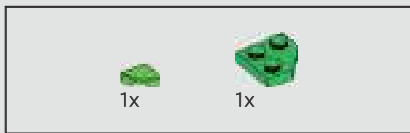

42

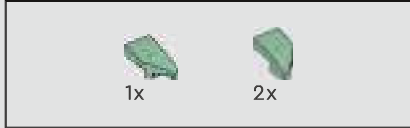
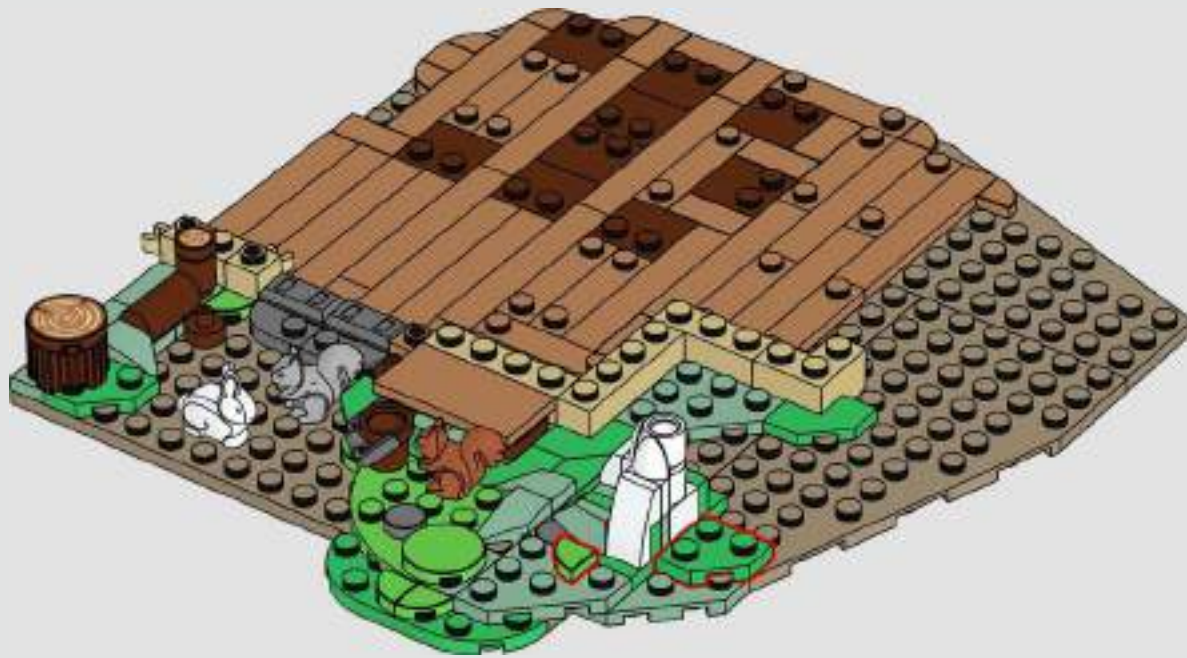

43

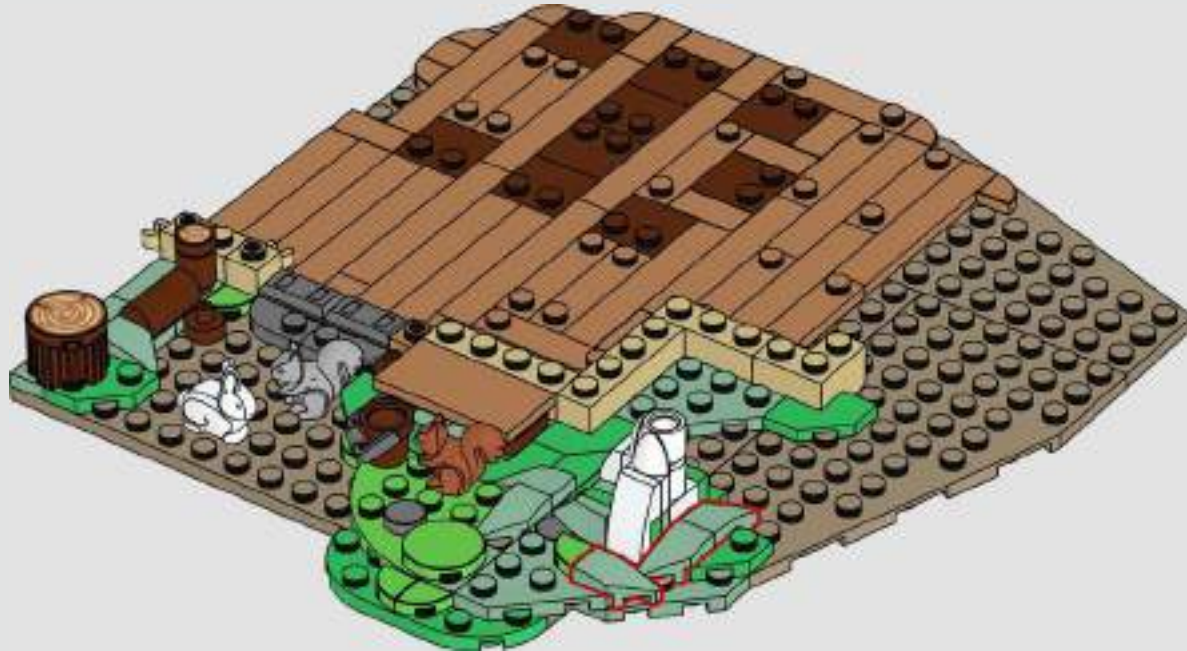

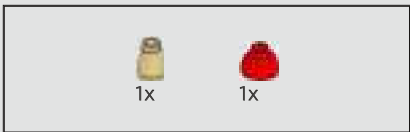

44

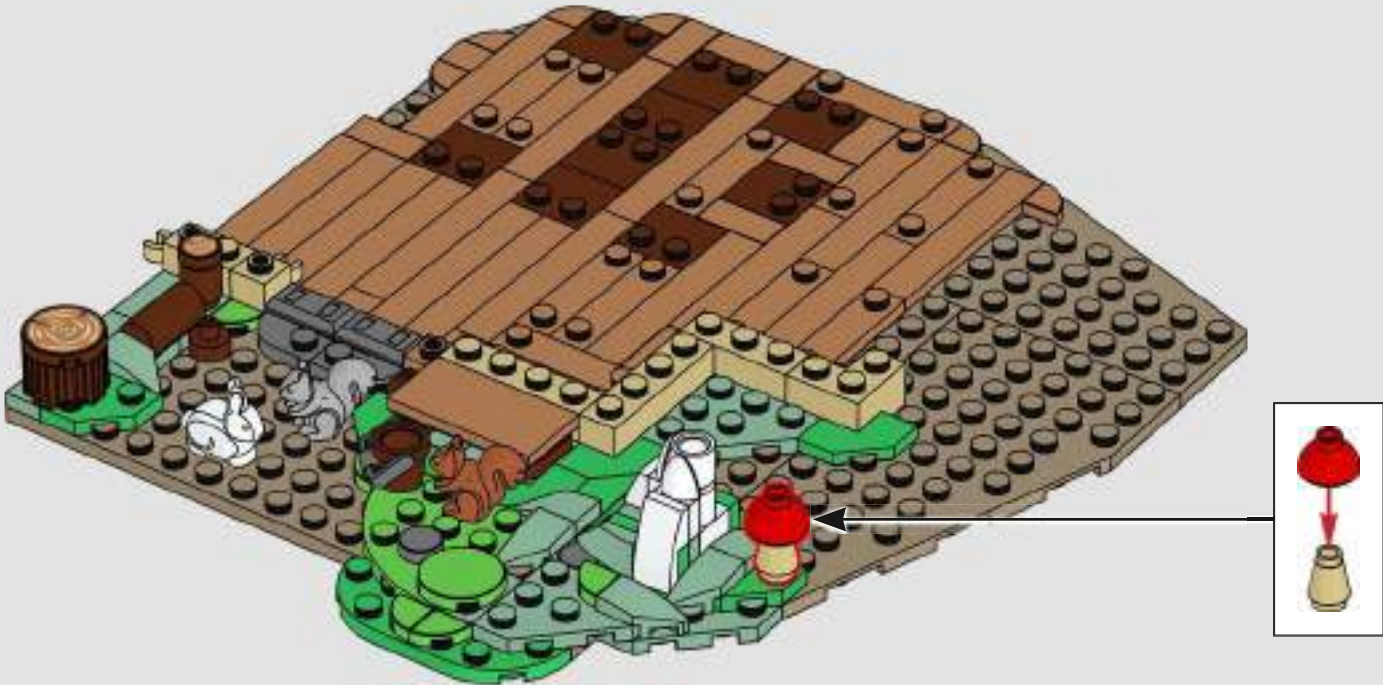

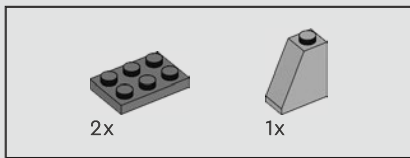

45

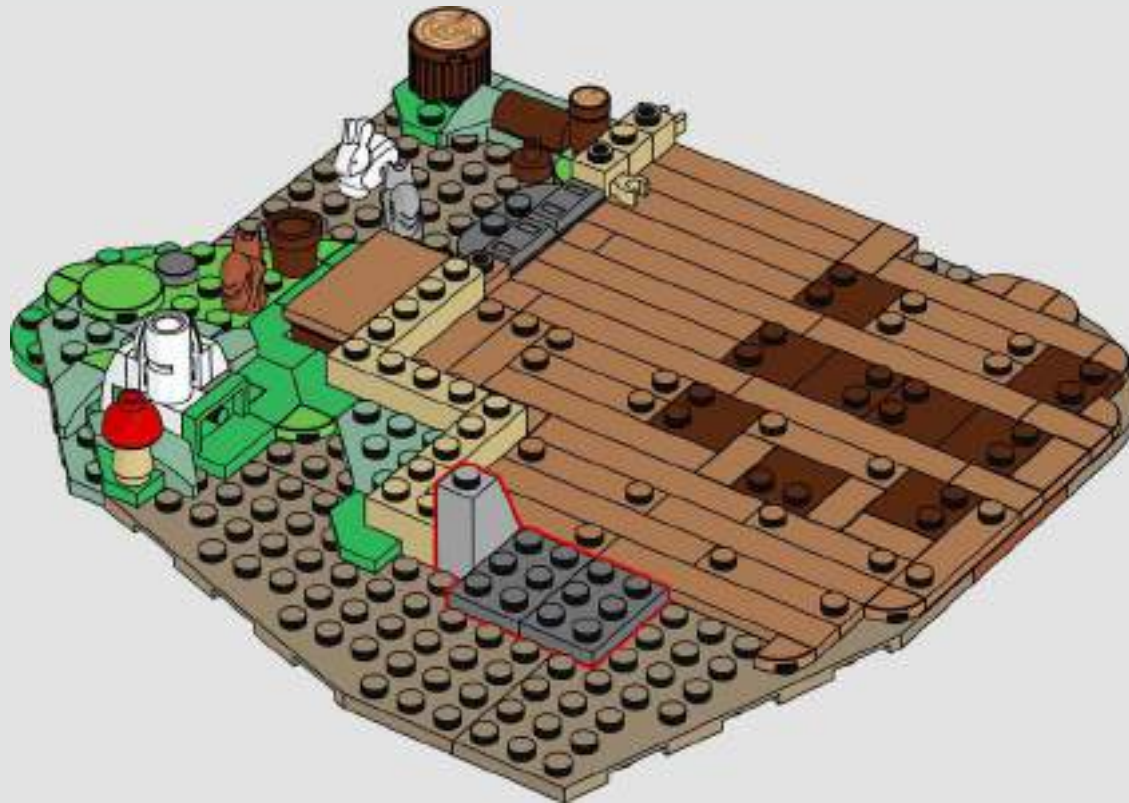



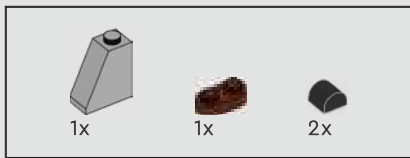

46

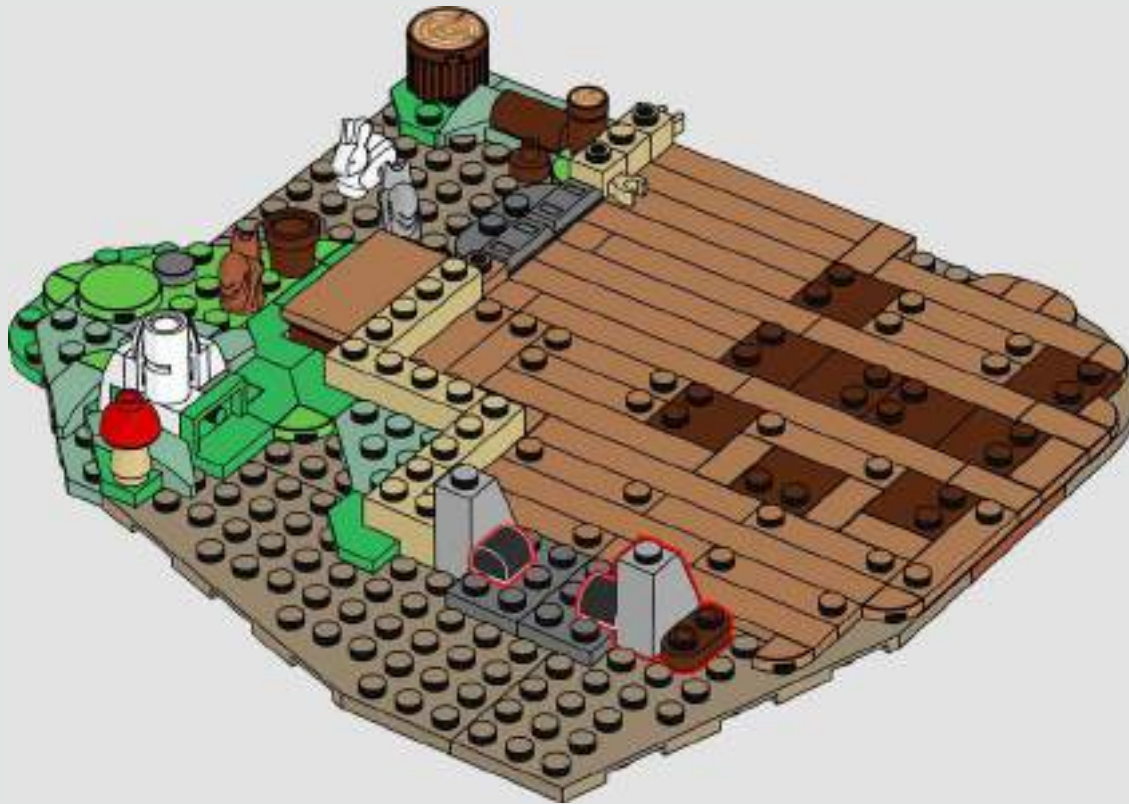



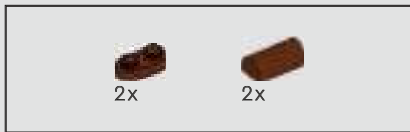

47

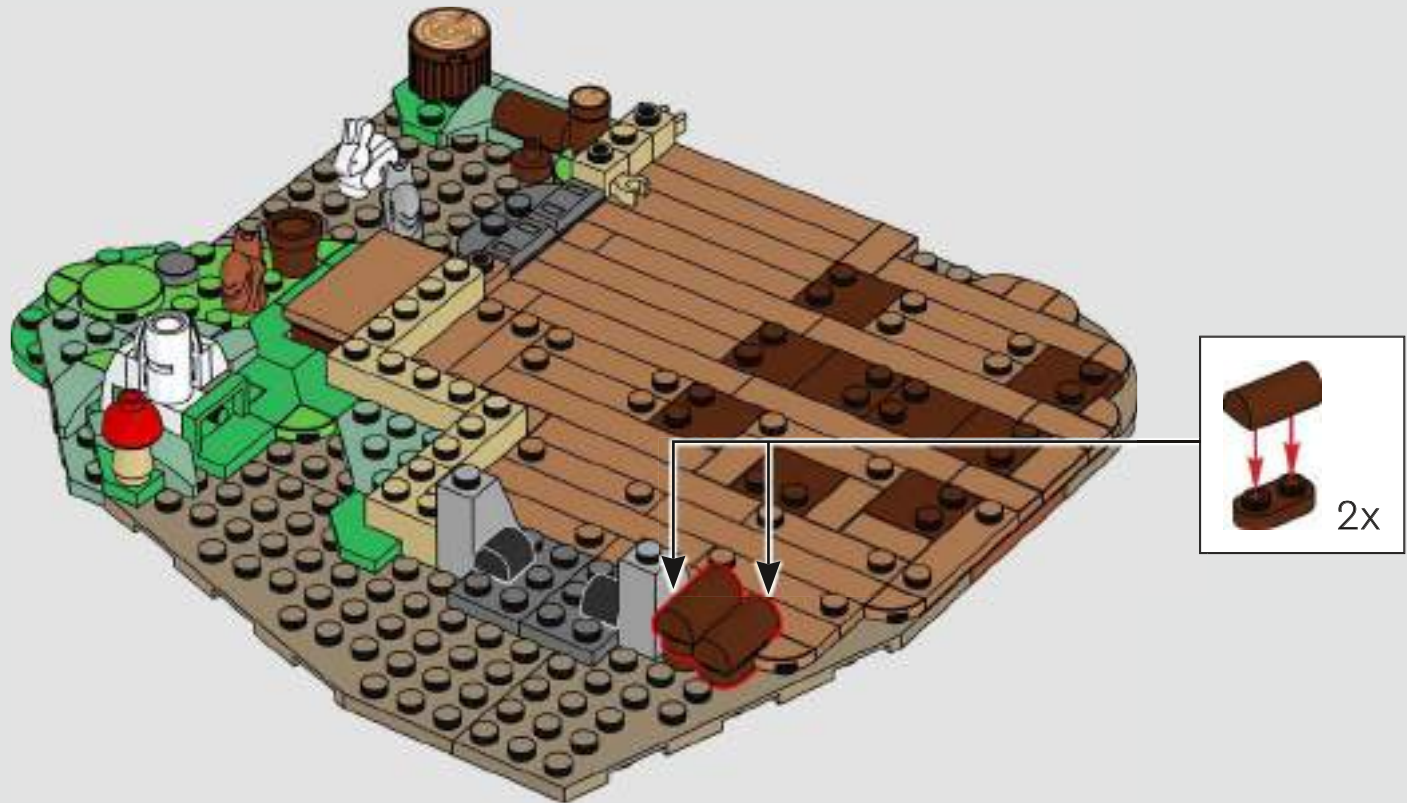

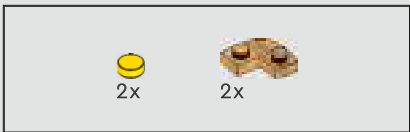

48



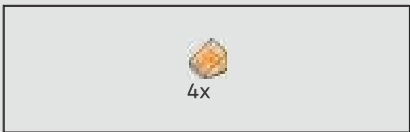

49





50

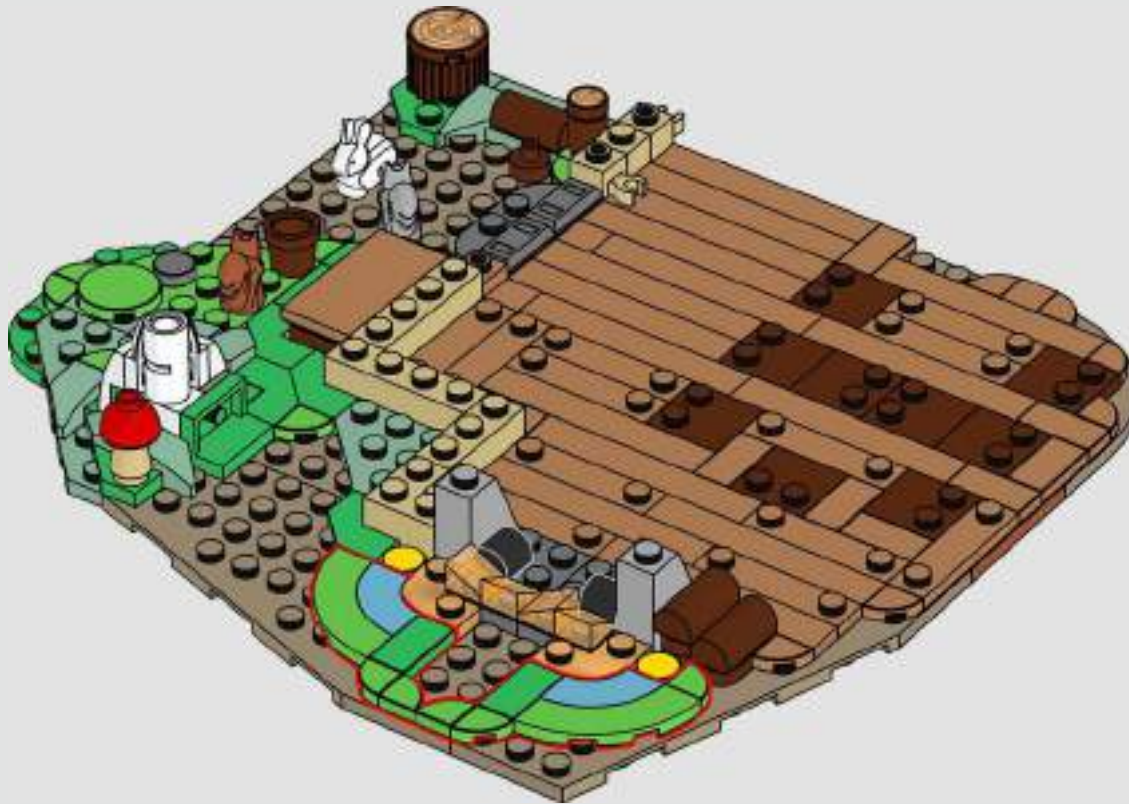



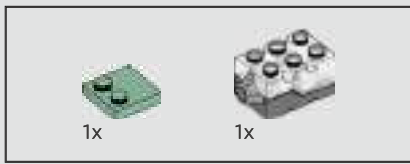

51

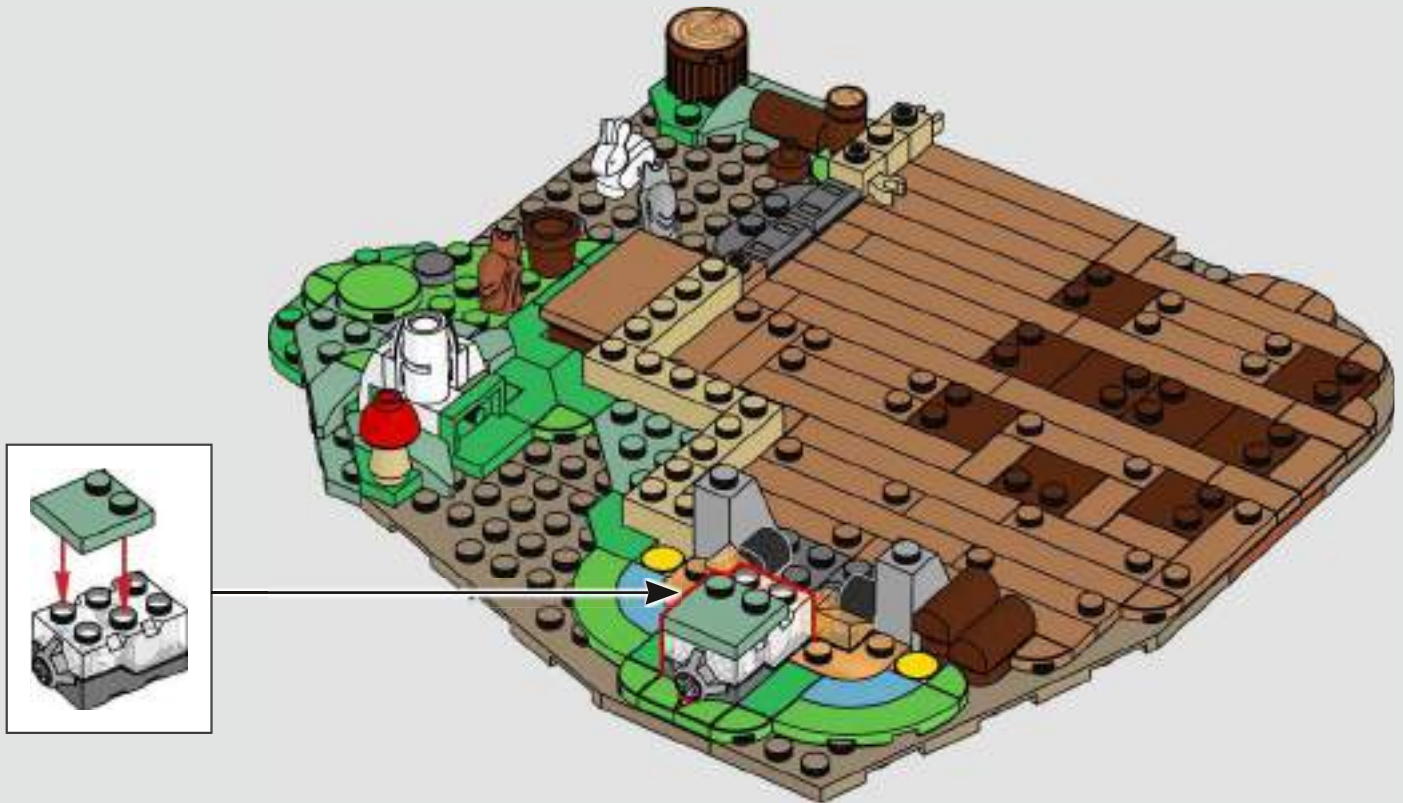
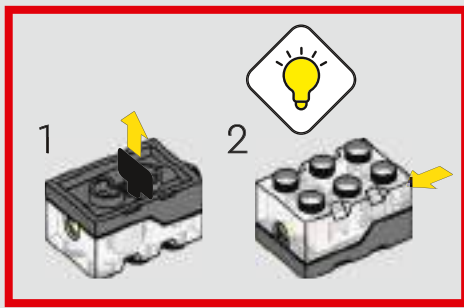





52

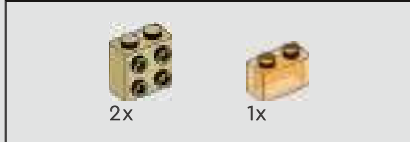

53







54

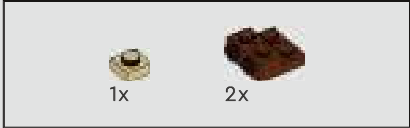

55





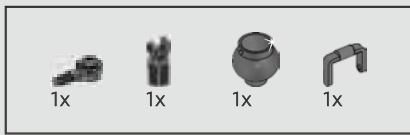

56

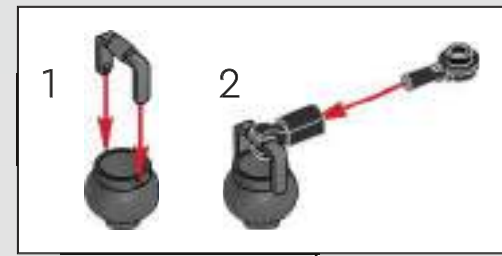
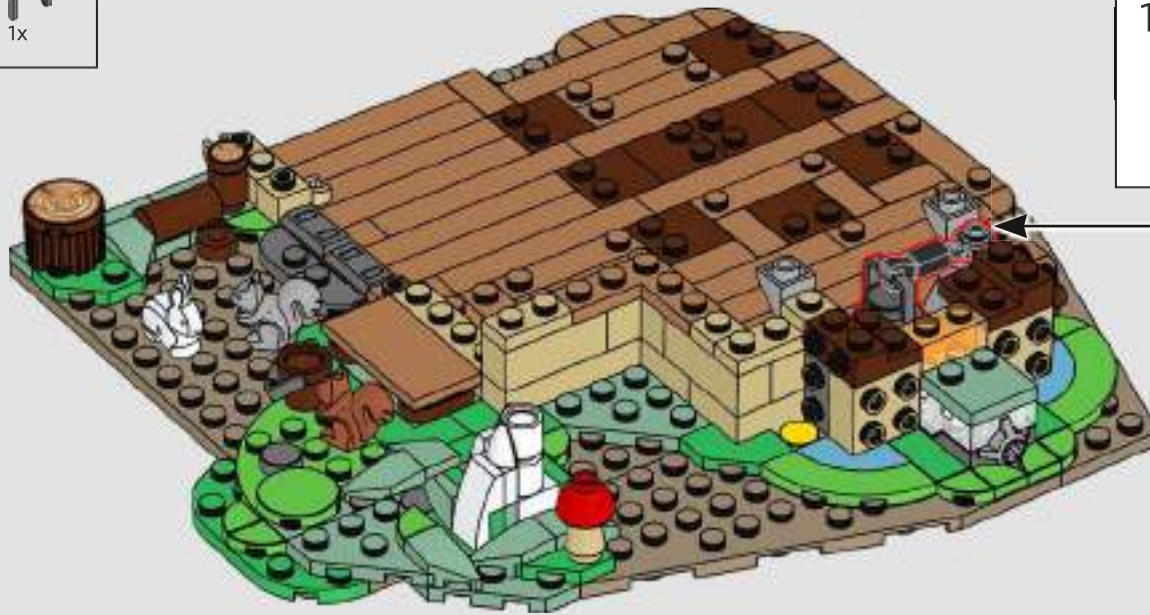

57



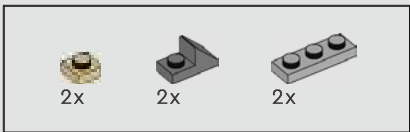

58



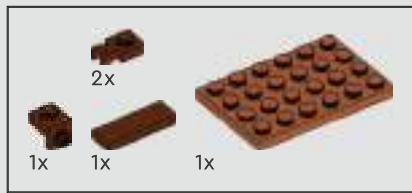

59







60

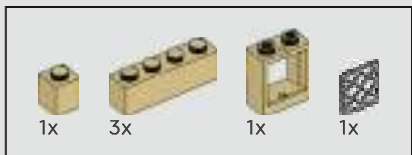

61





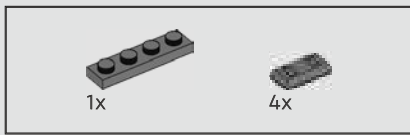

62

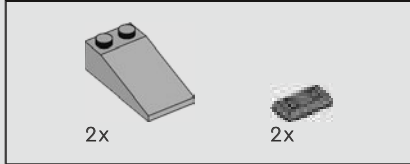

63

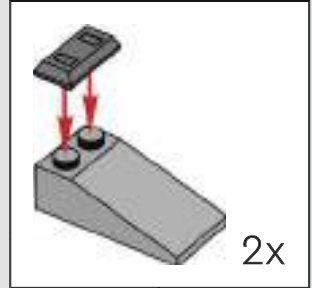
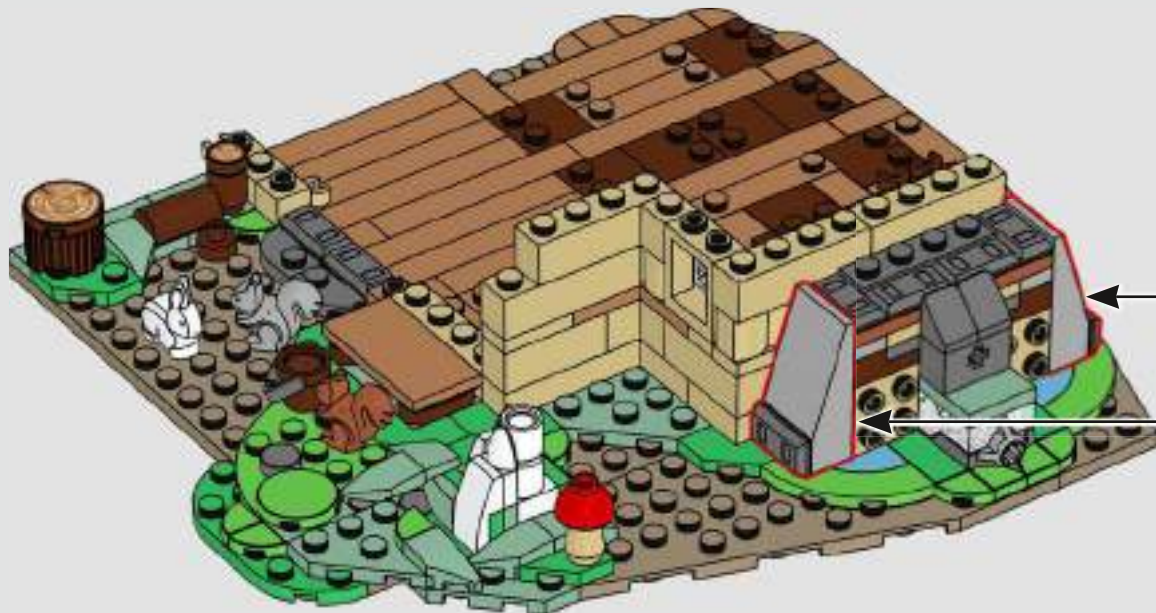

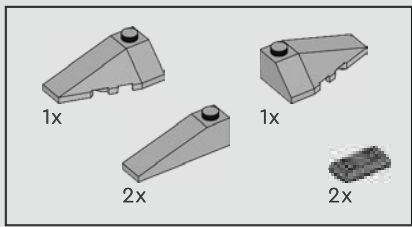

64

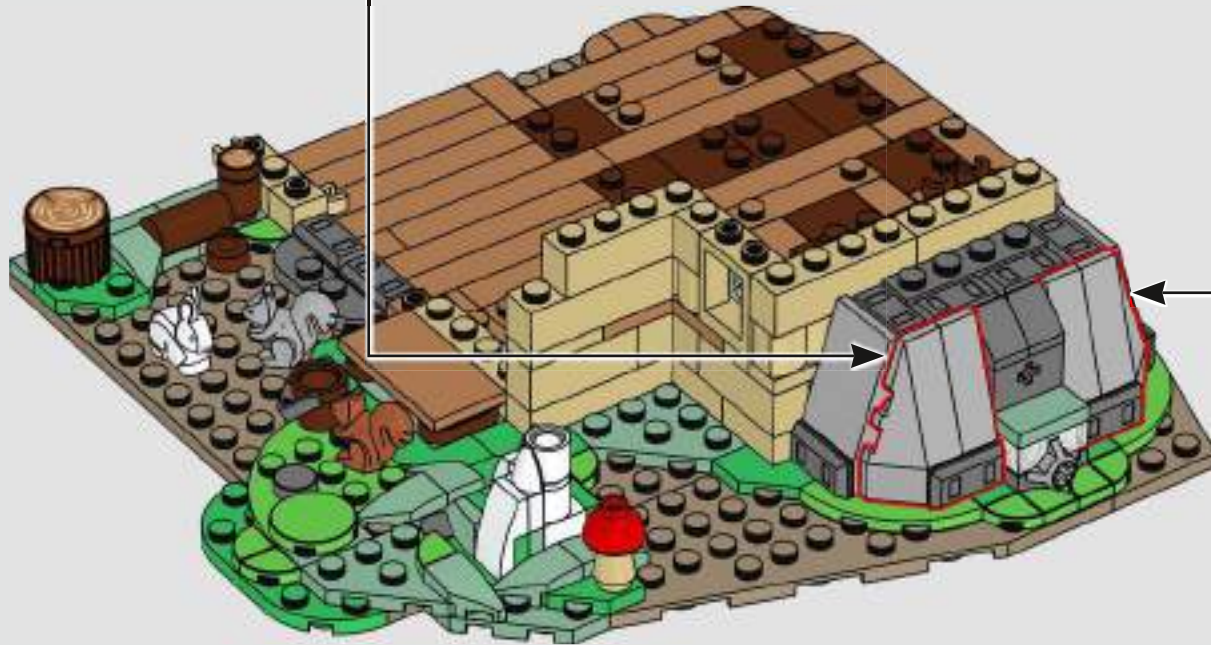
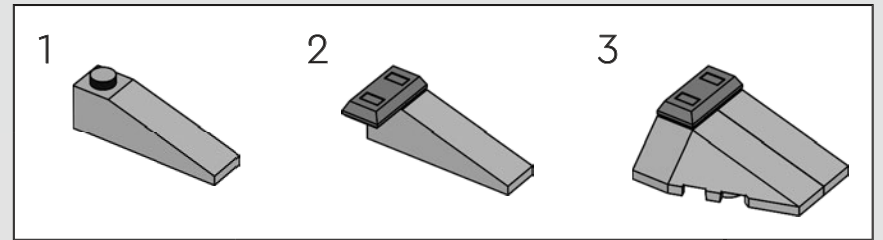
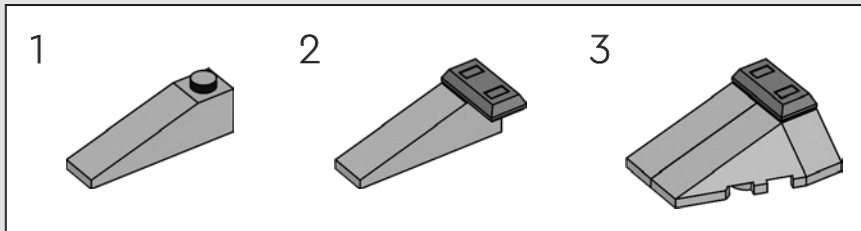





65

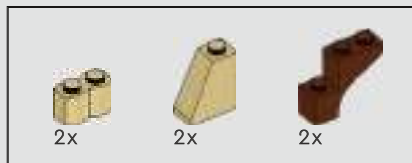
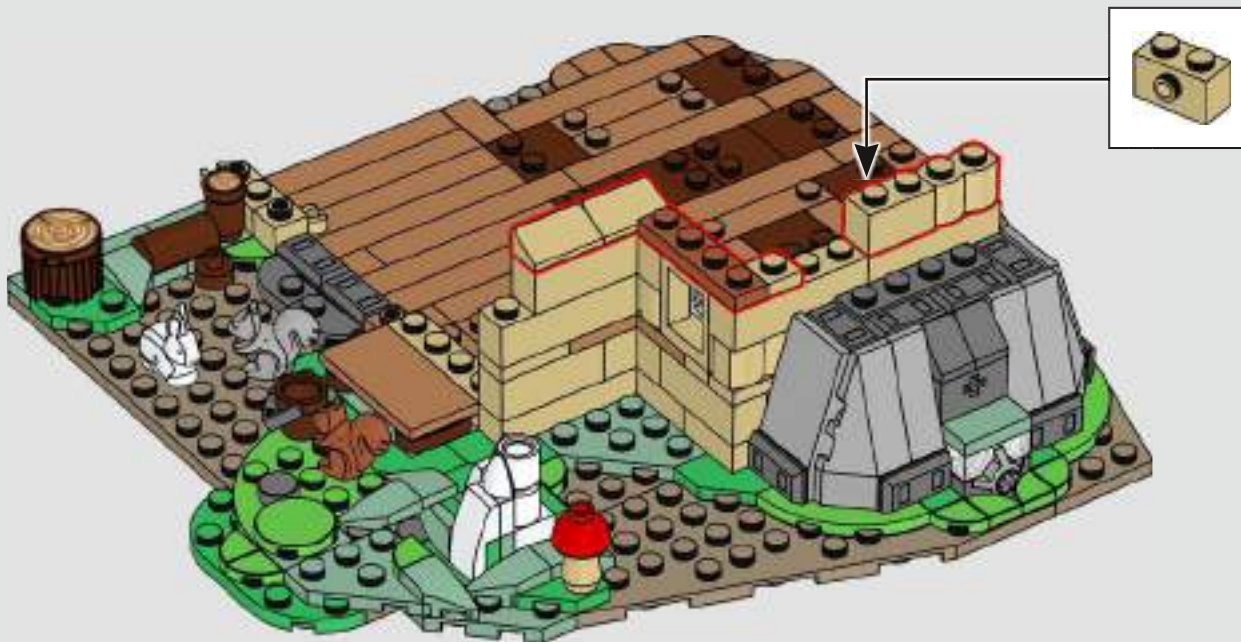

66

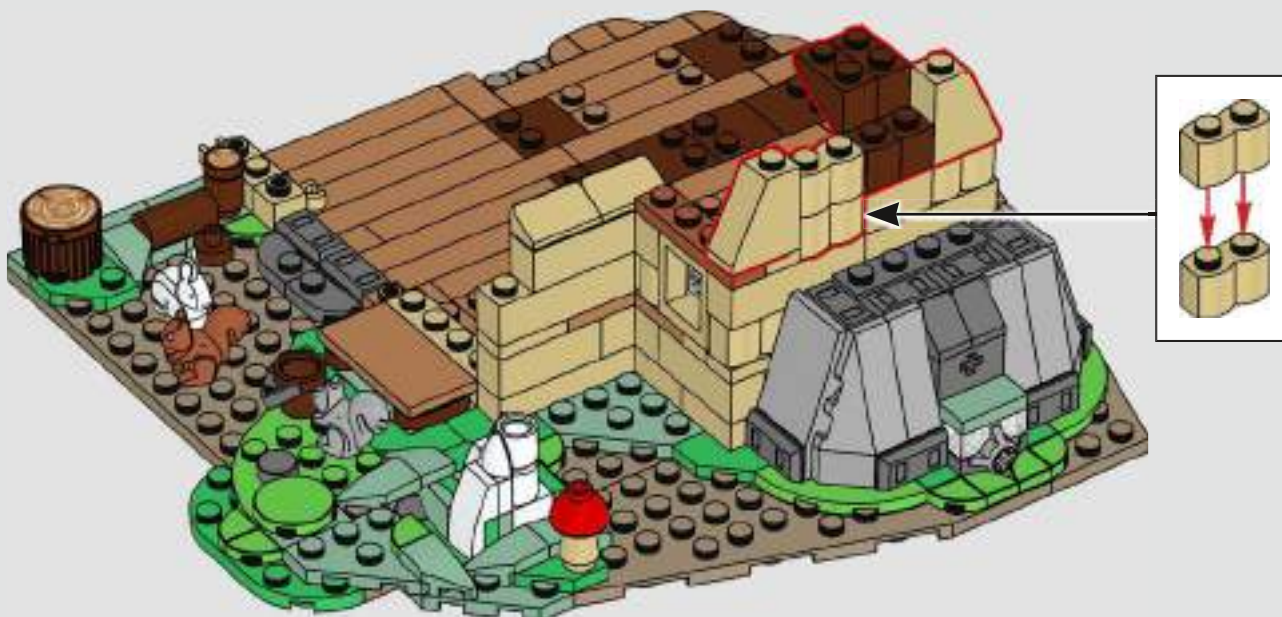



67







68

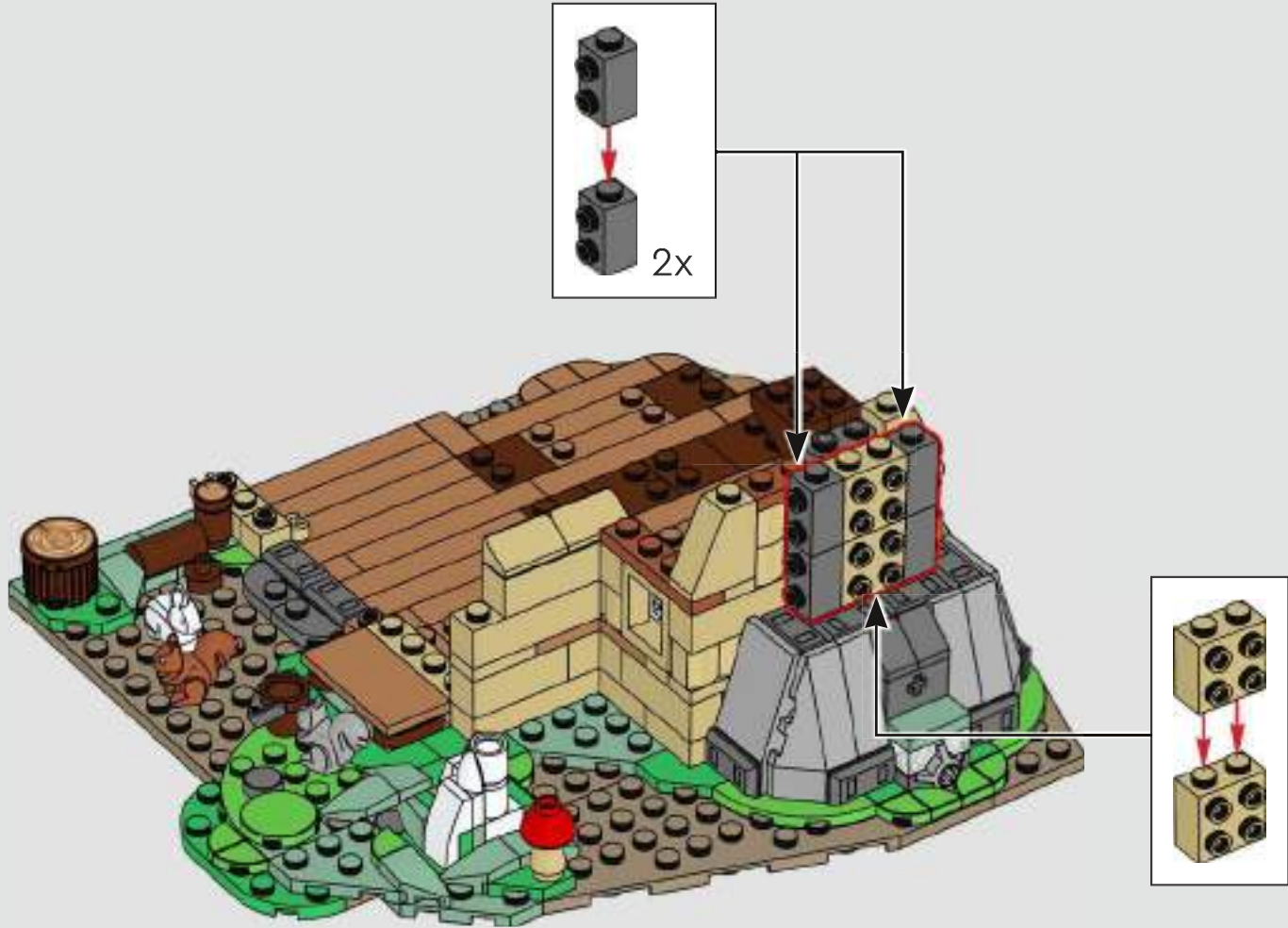

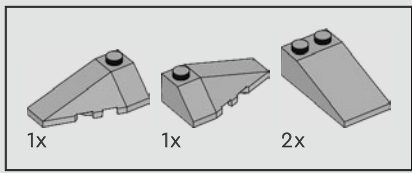

69

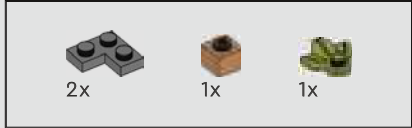
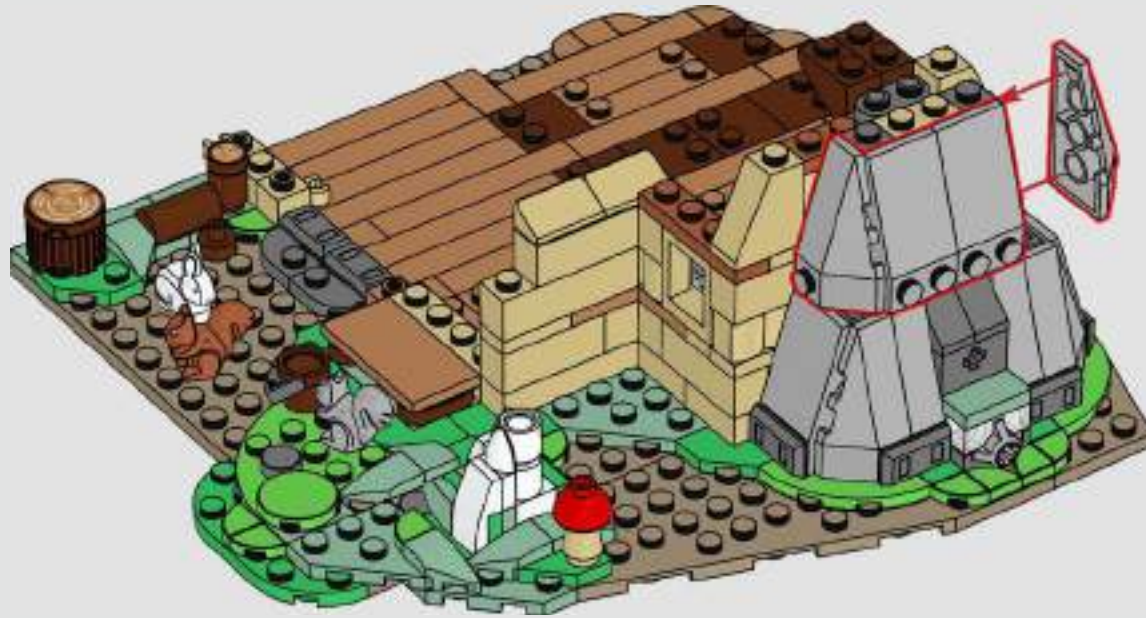

70

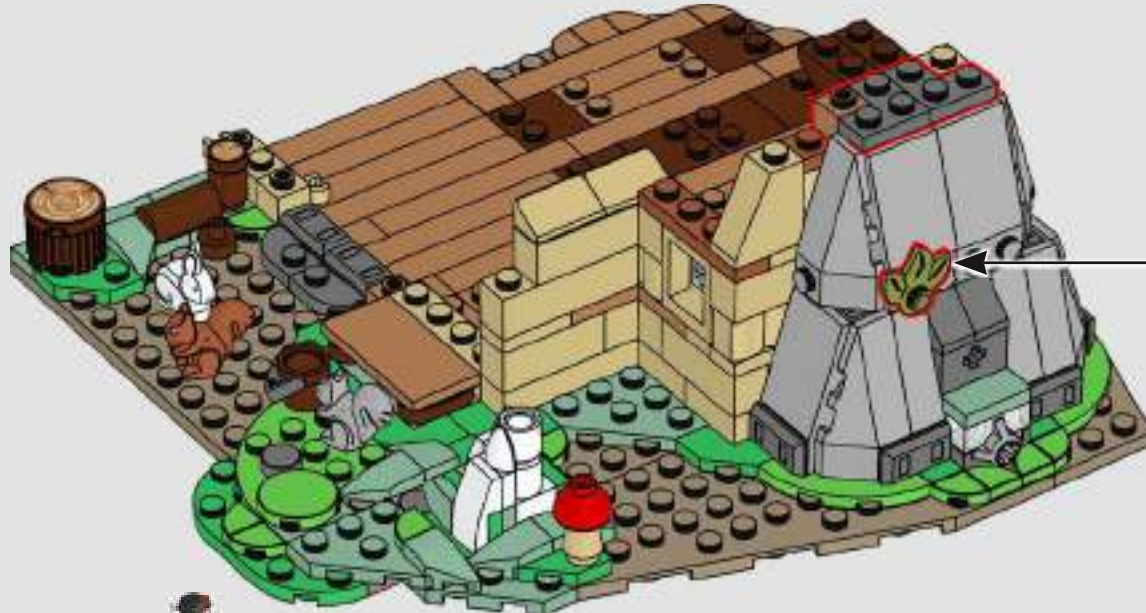

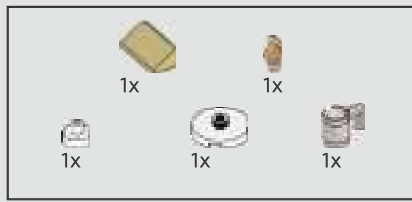

71

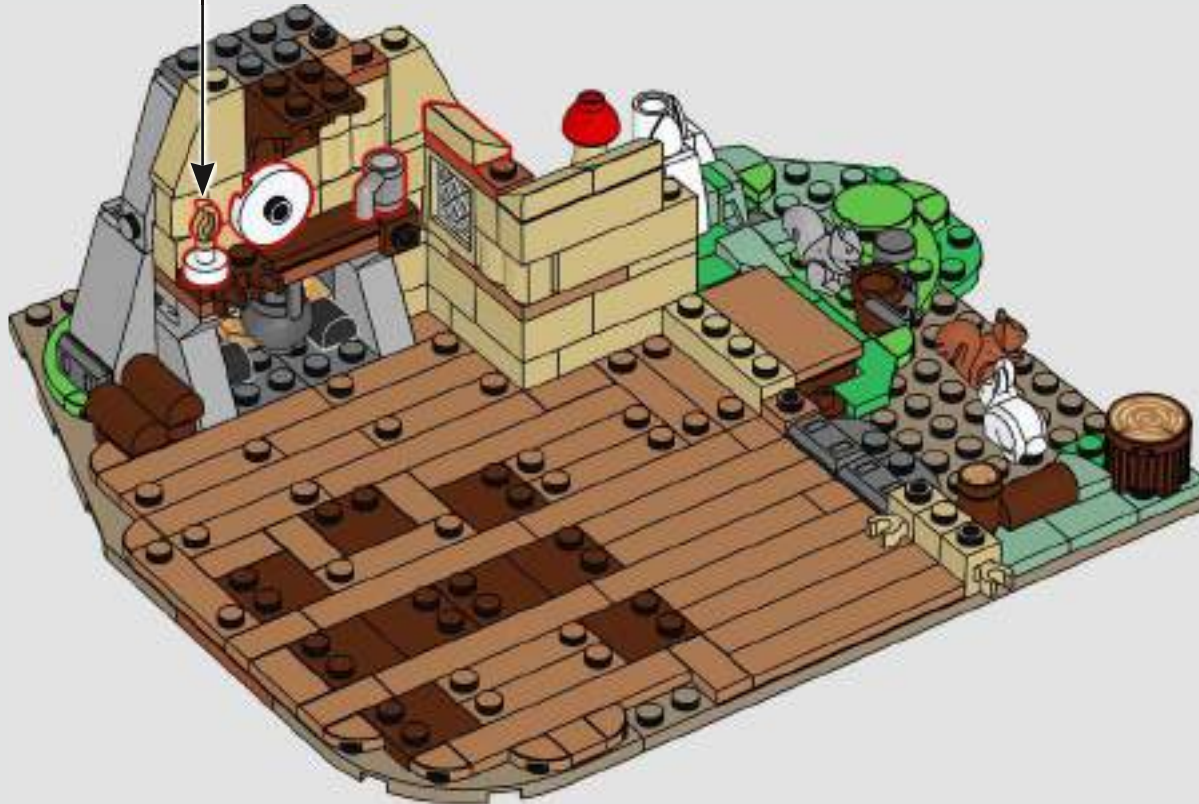





72

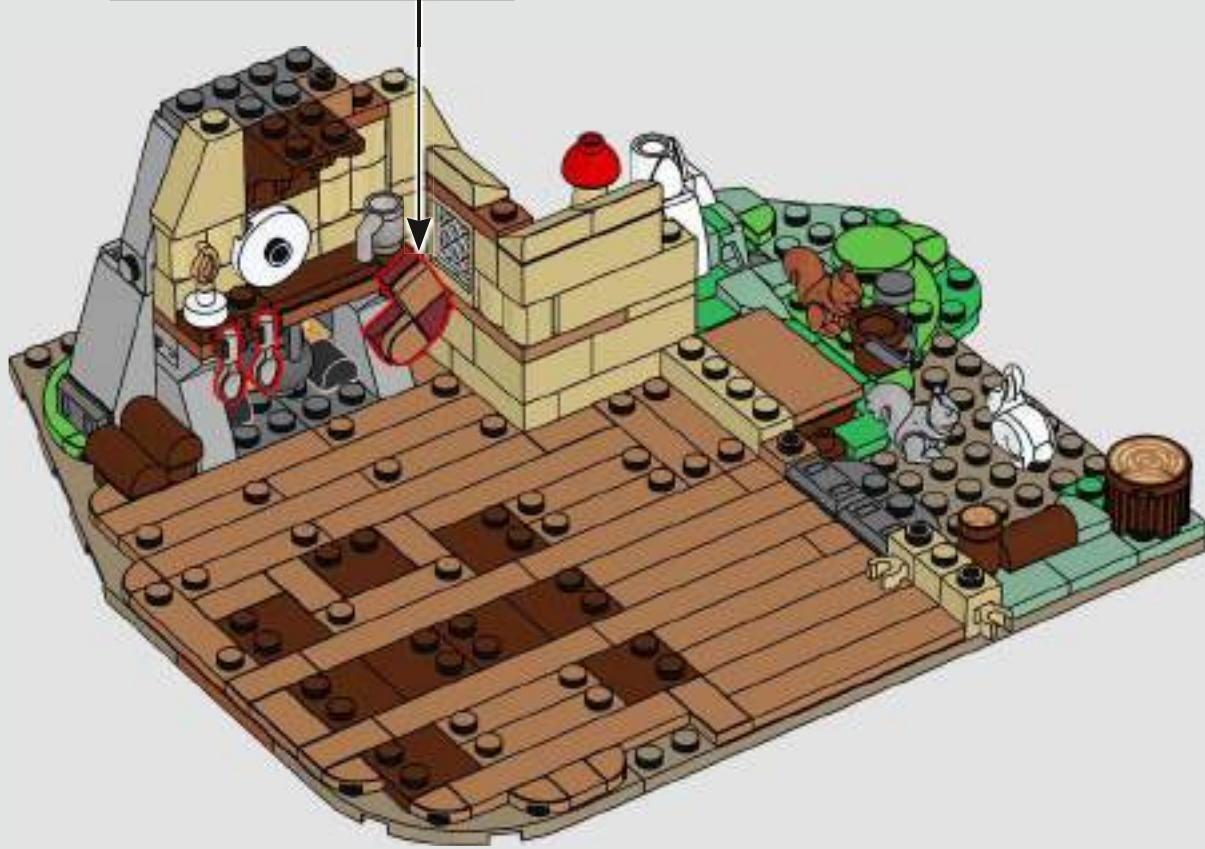
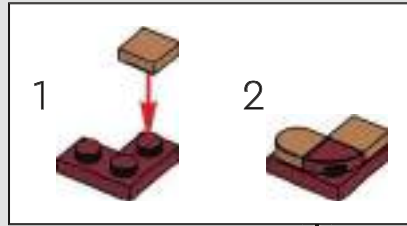





73

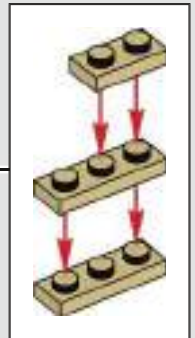
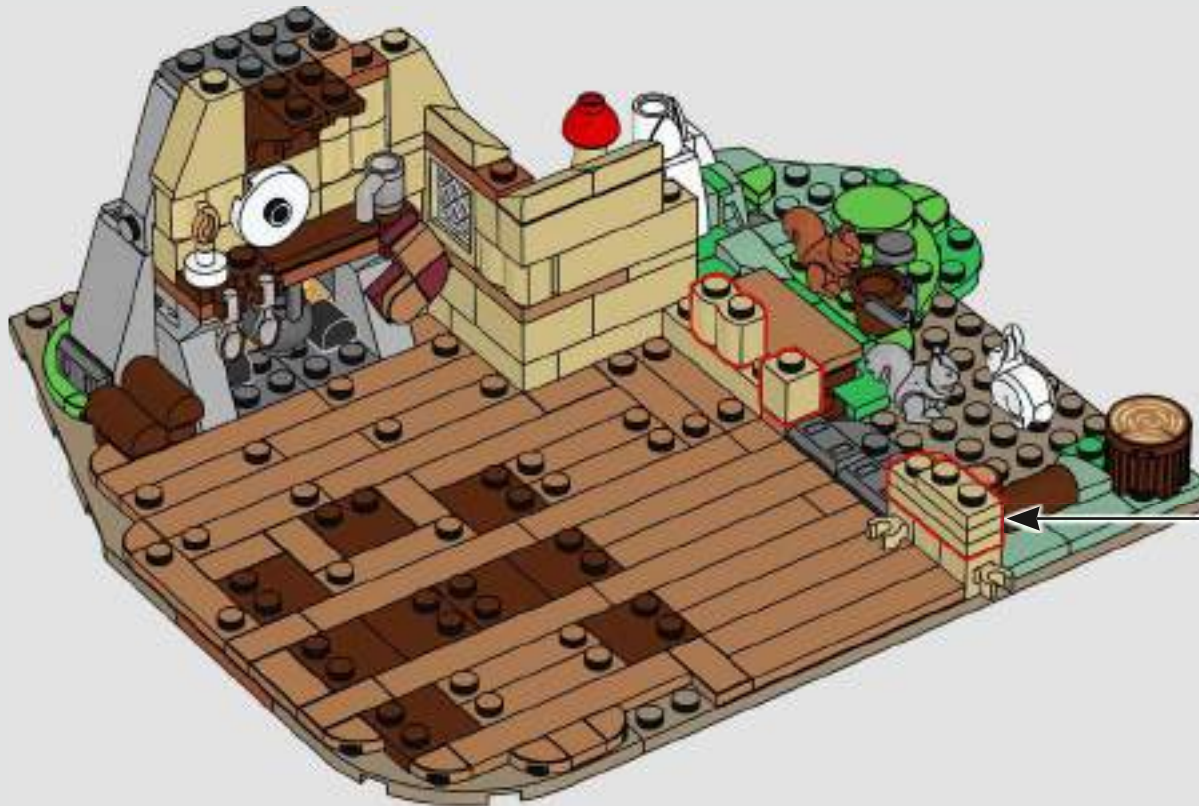



2x

74

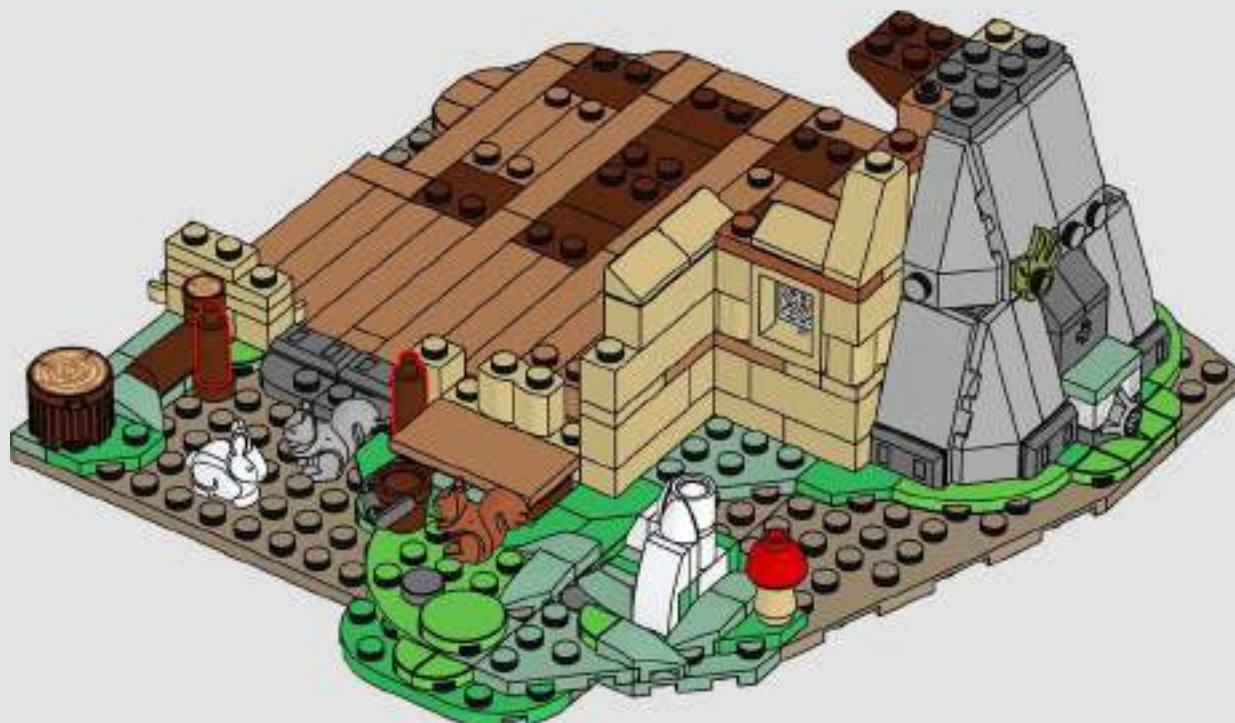

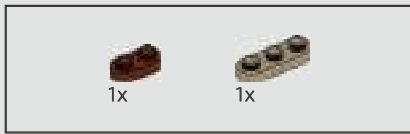

75





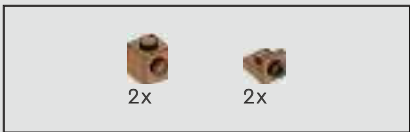

76

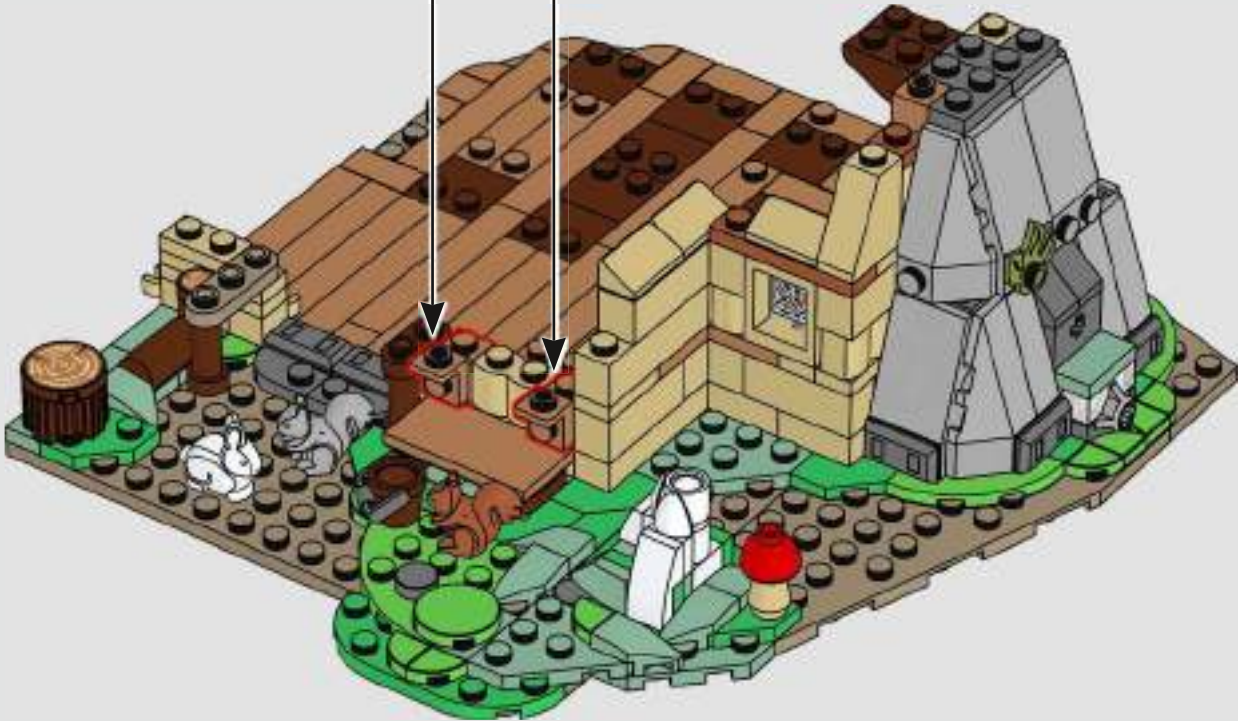
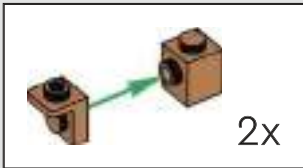

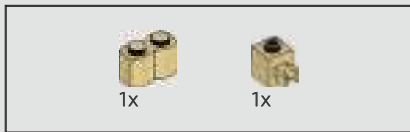

77



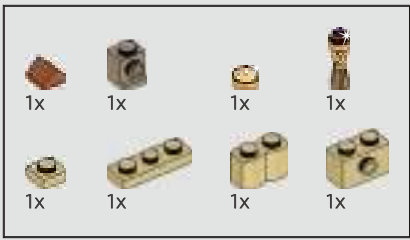

78

1

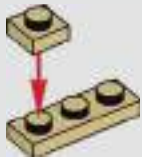

2

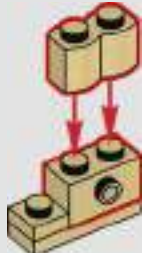

3

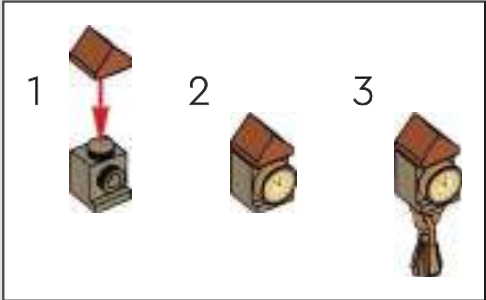



79



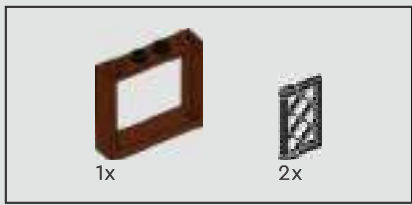

80



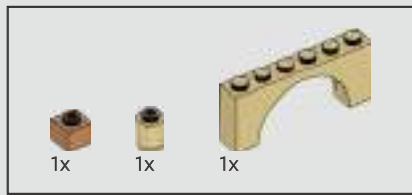

81

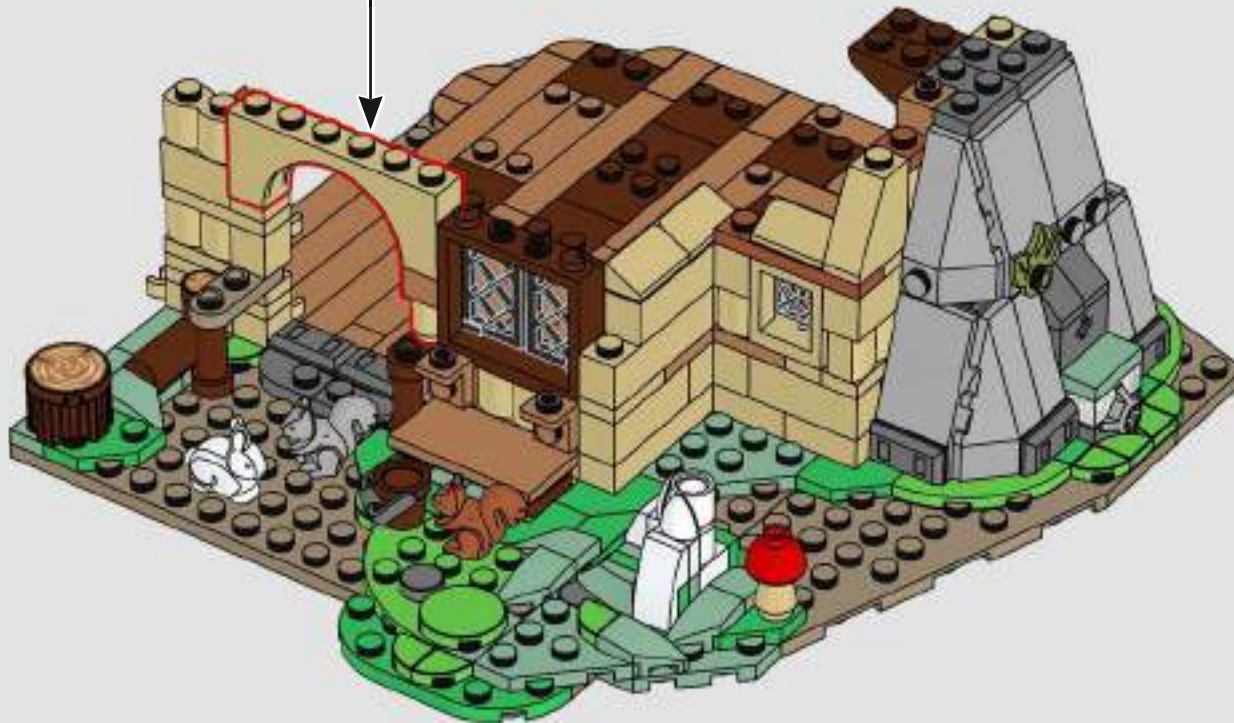
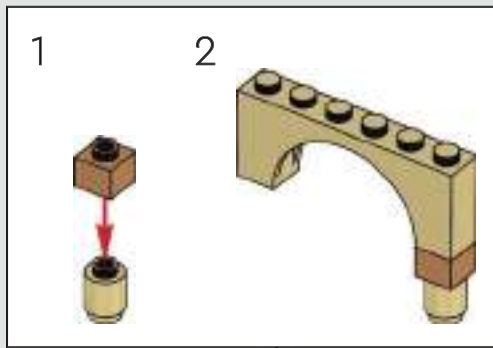





82





83

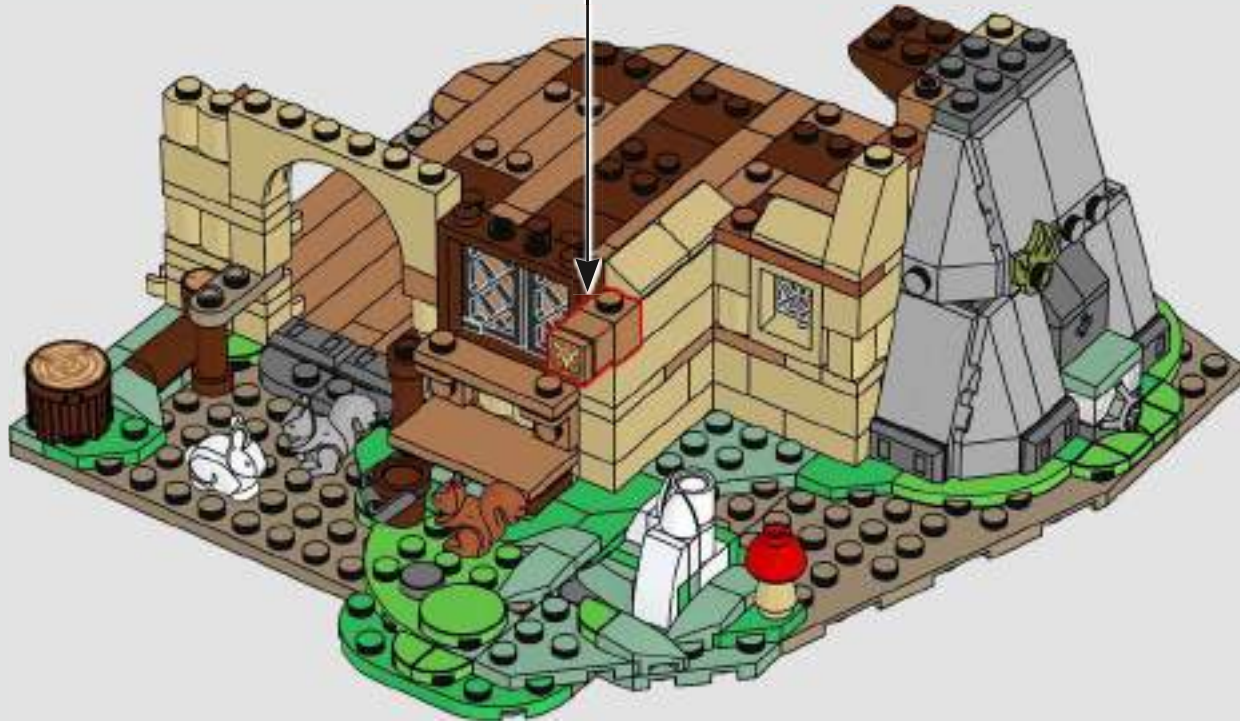
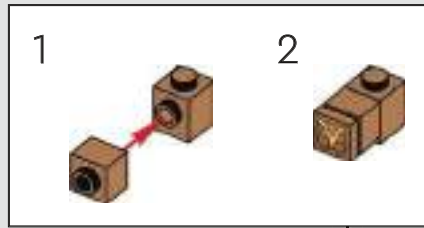

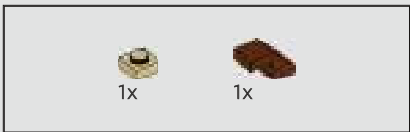

84





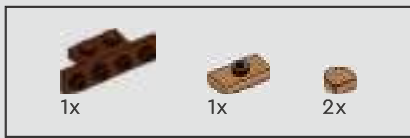

85

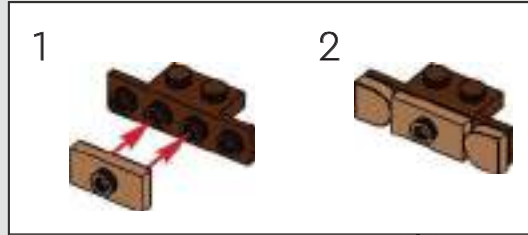

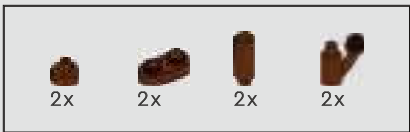

86

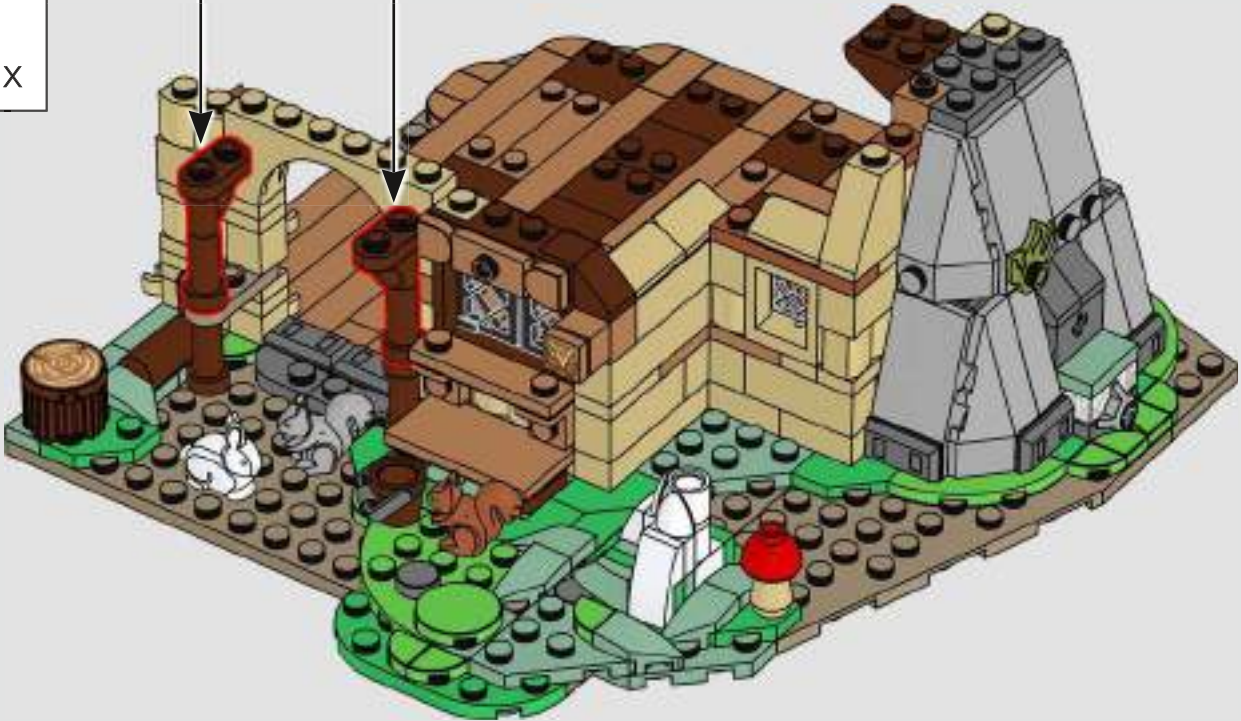
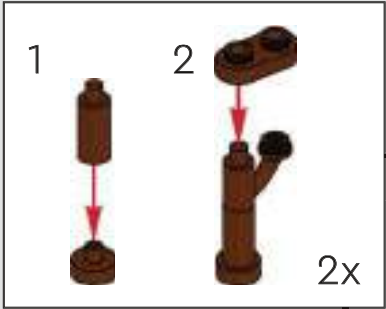



87





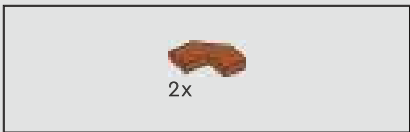

88



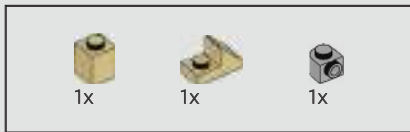

89

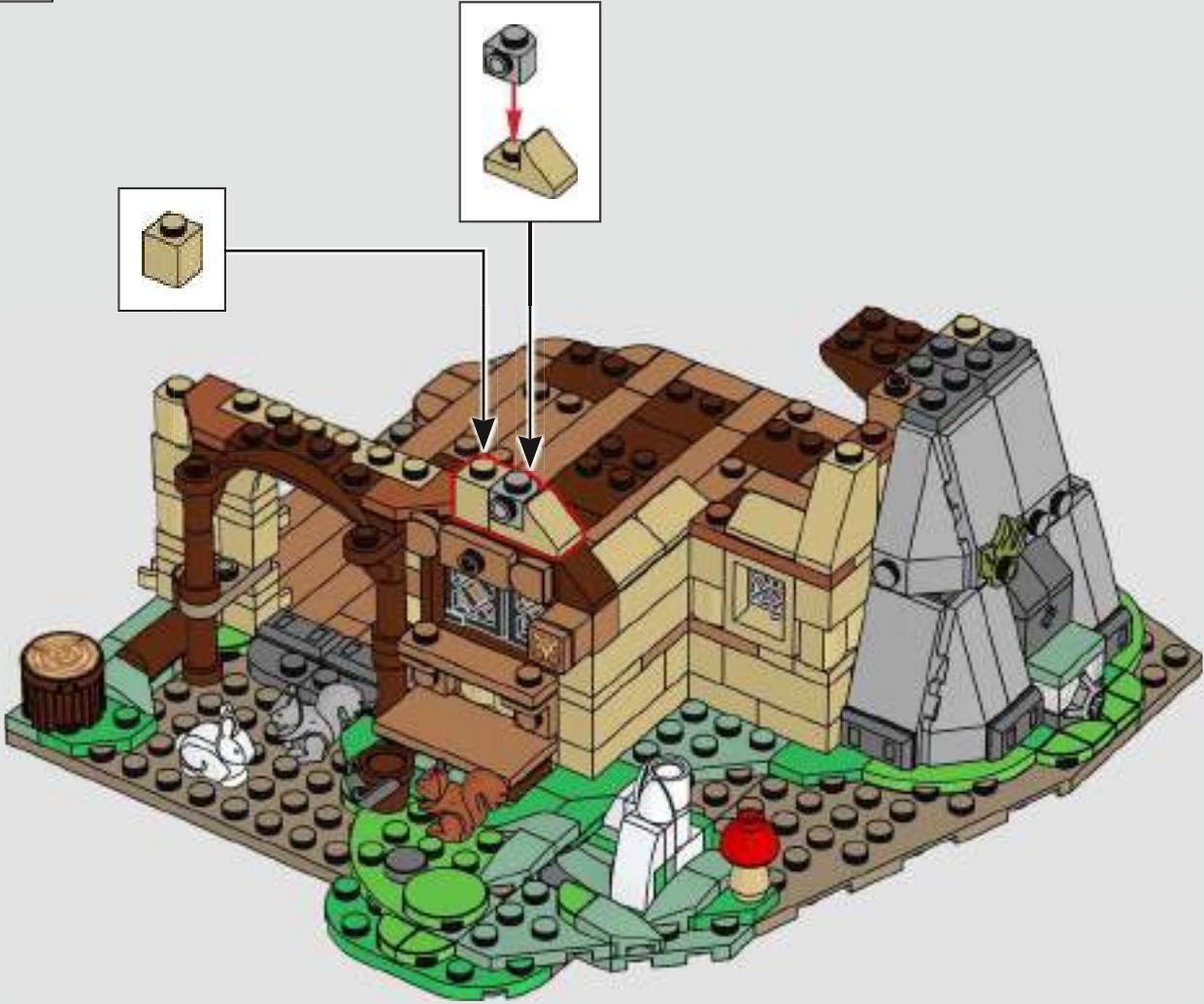



90

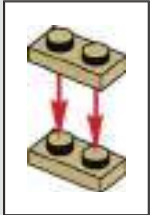



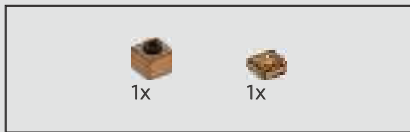

91

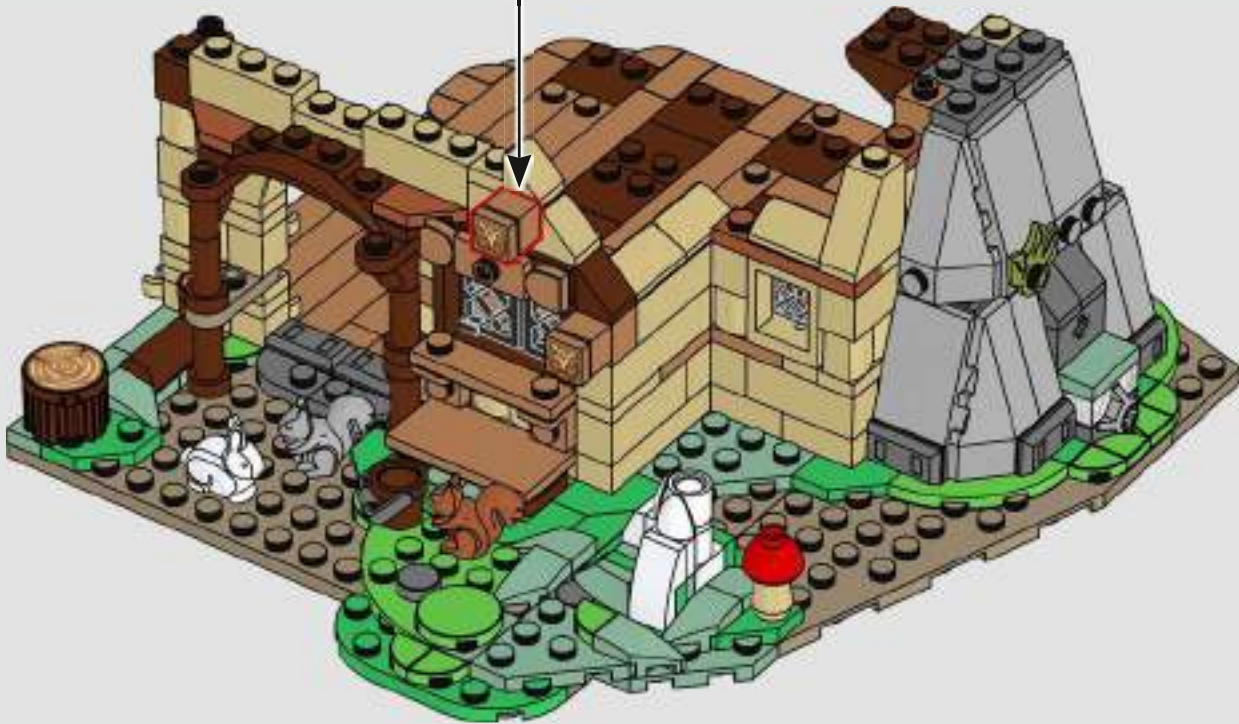



92

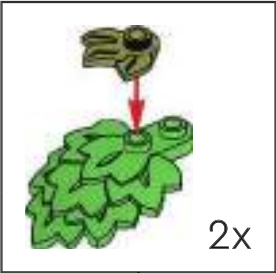



1x

93





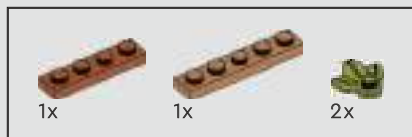

94





95





1x

96





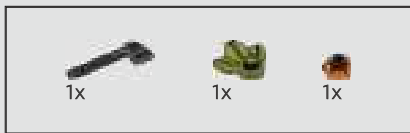

97

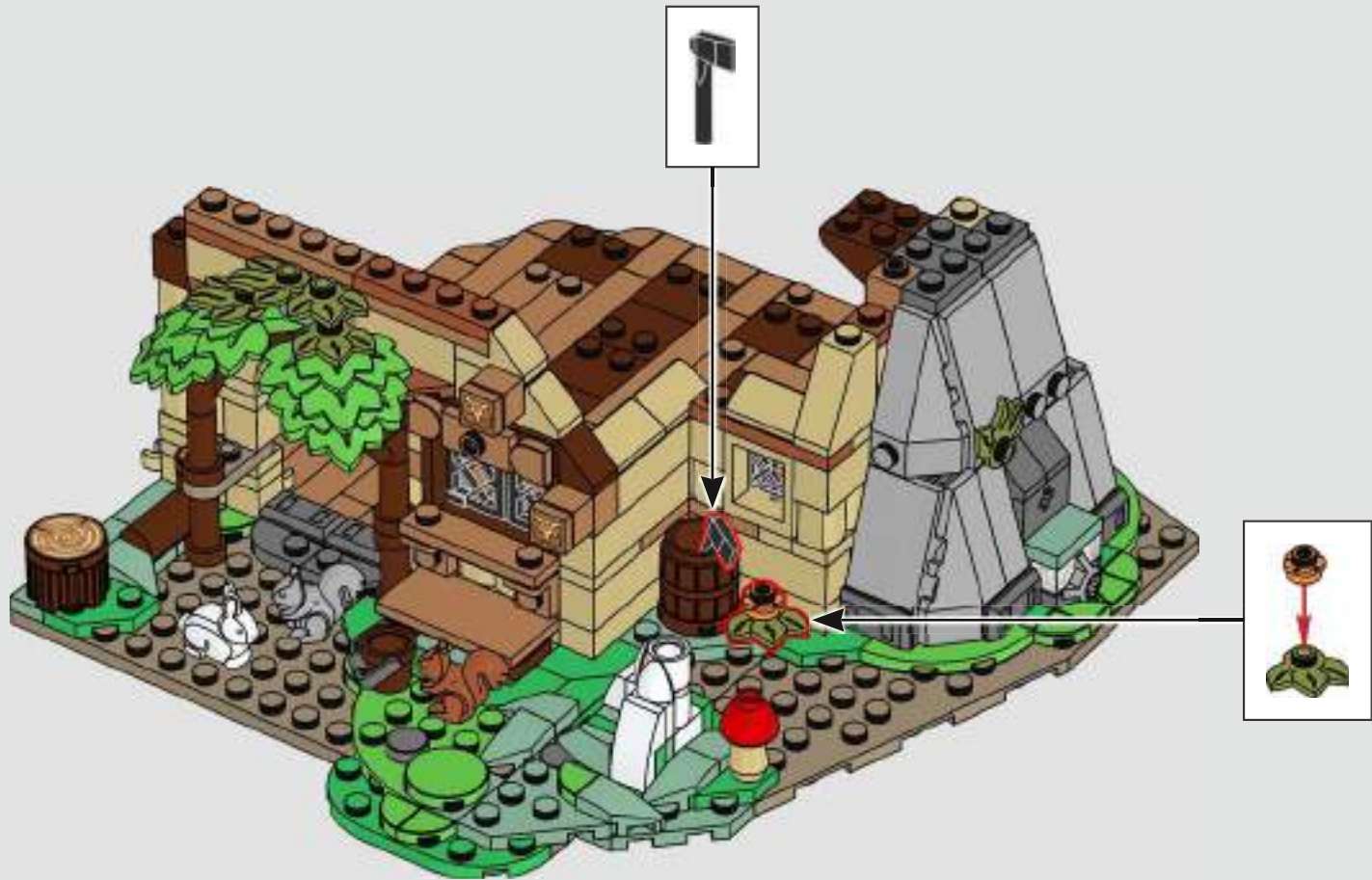

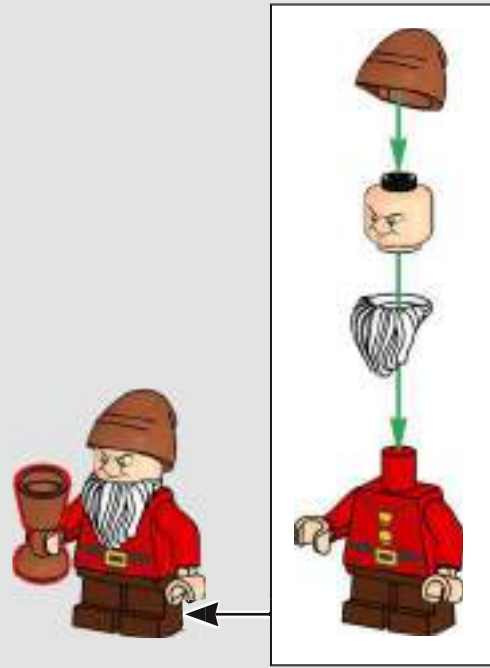



98

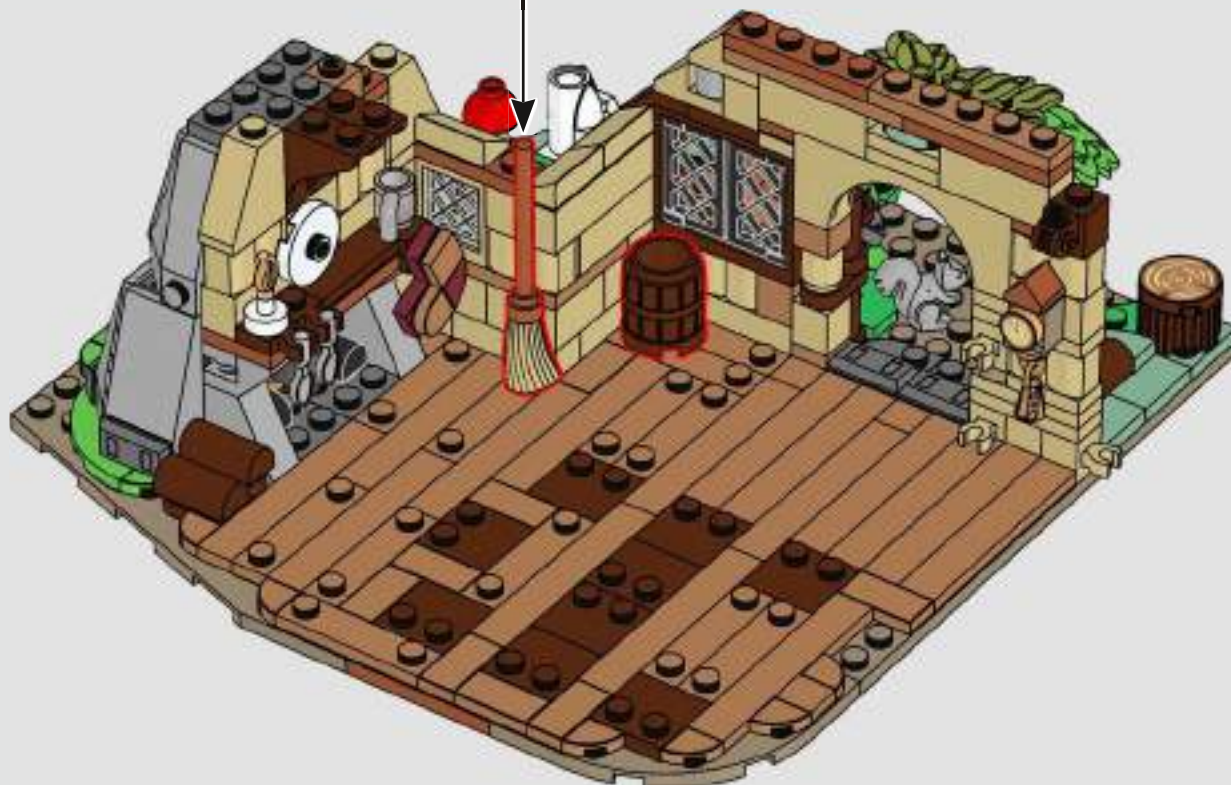



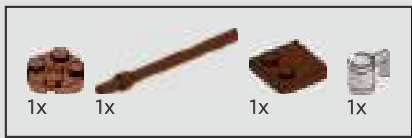

99

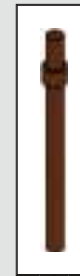
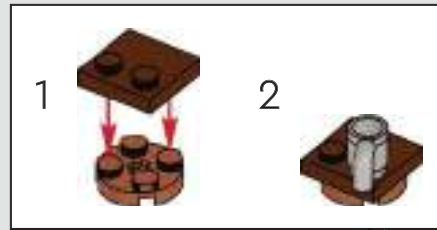



100

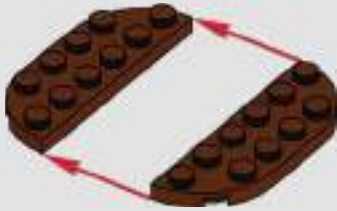

101

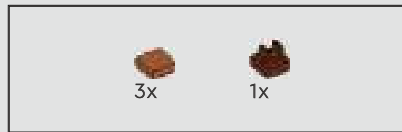

102



103





104



105

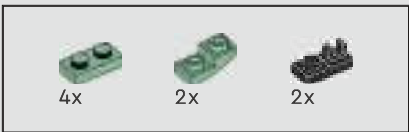

106

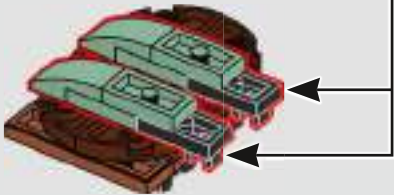
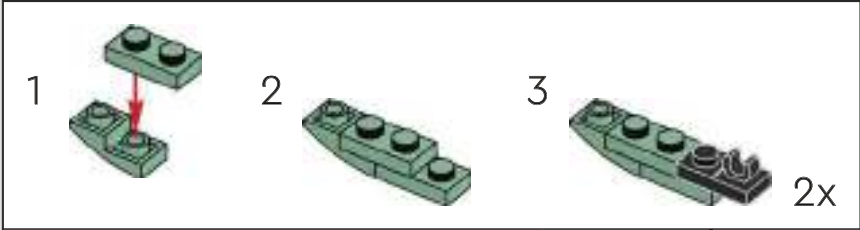



107

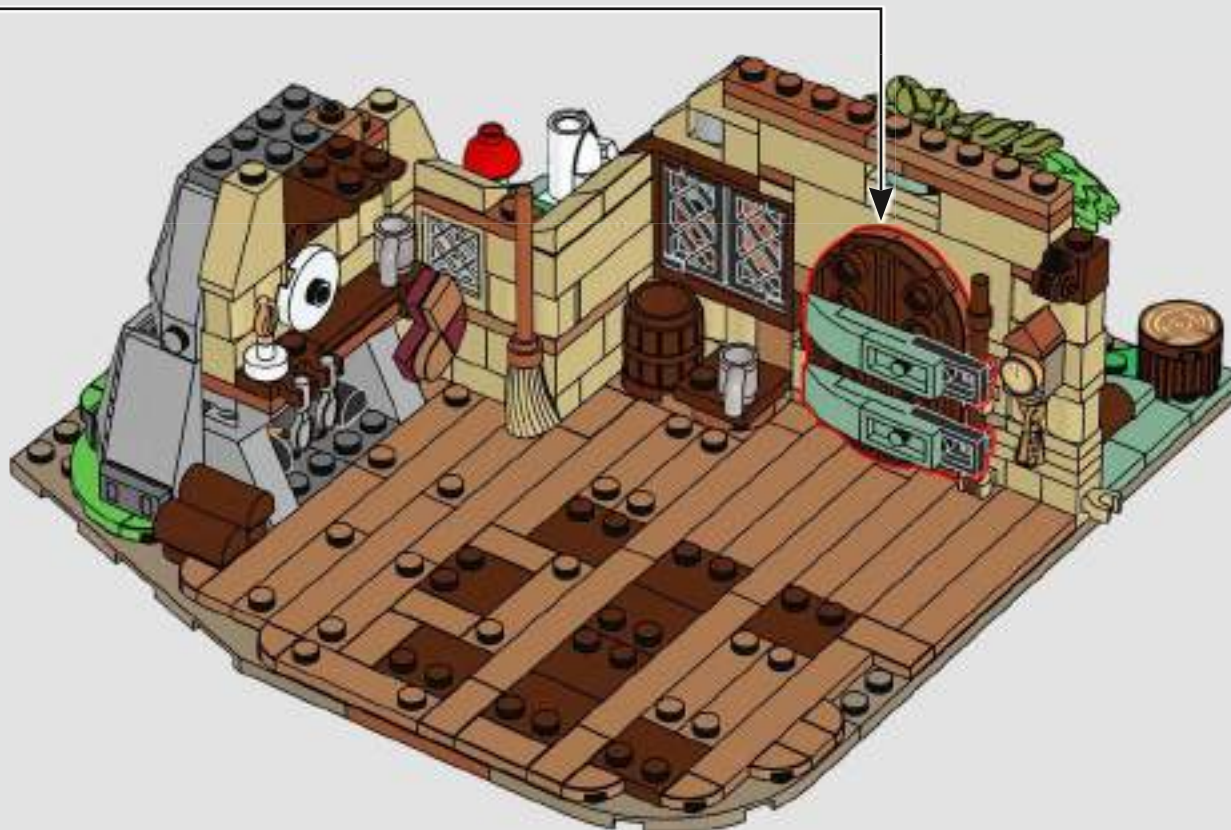



108

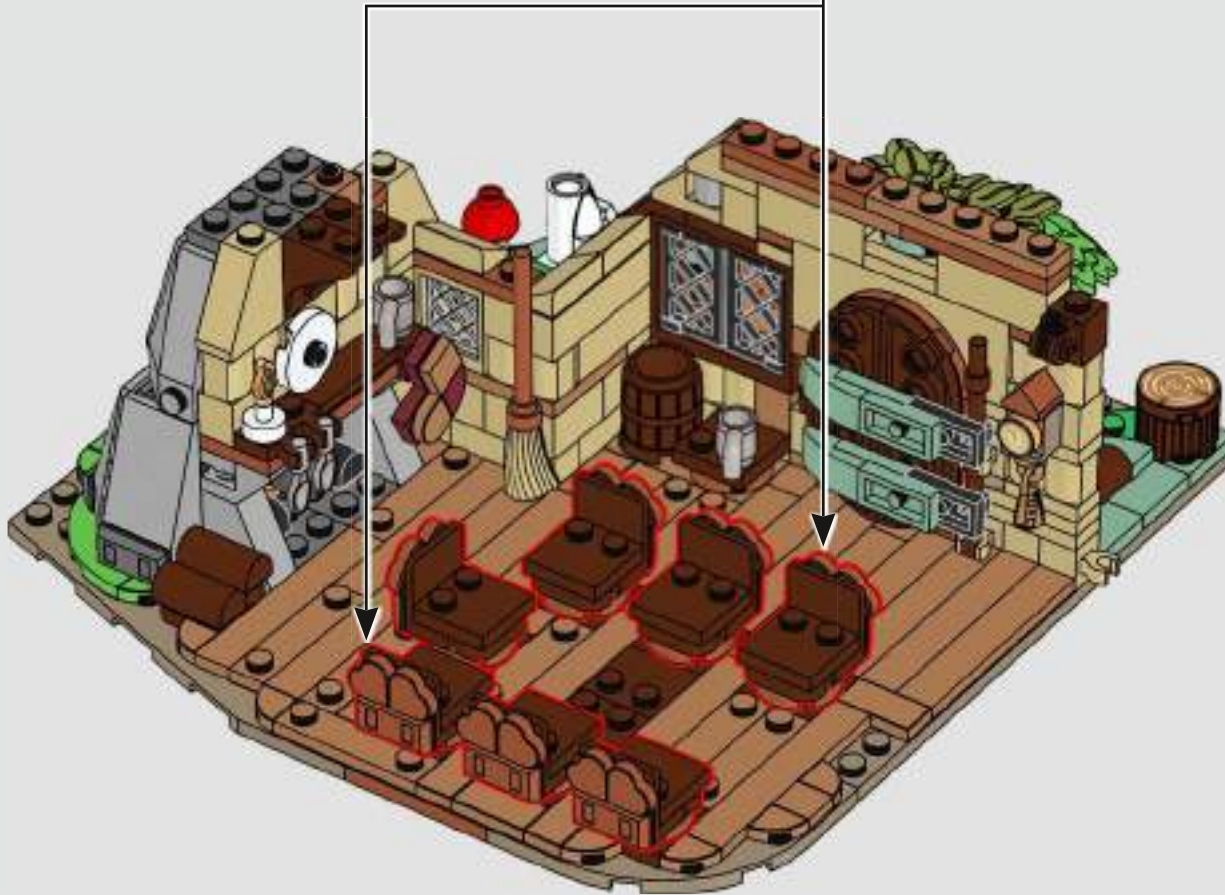
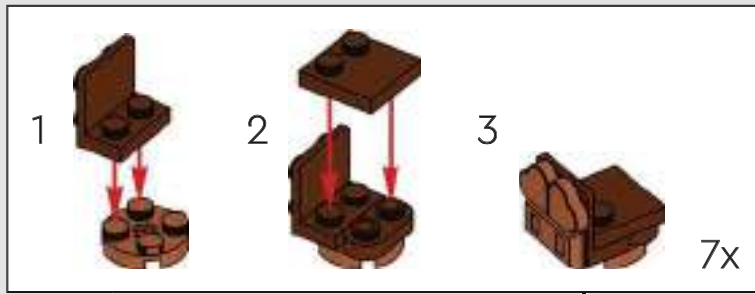



1x

109

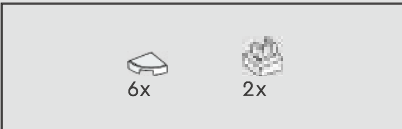
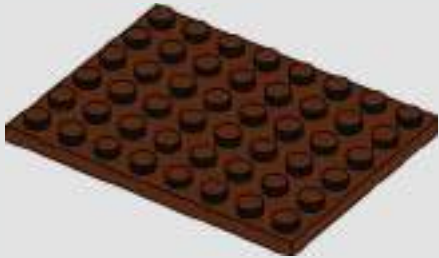

110

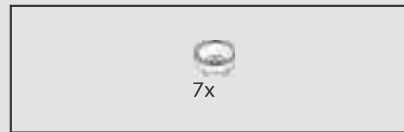

111







115



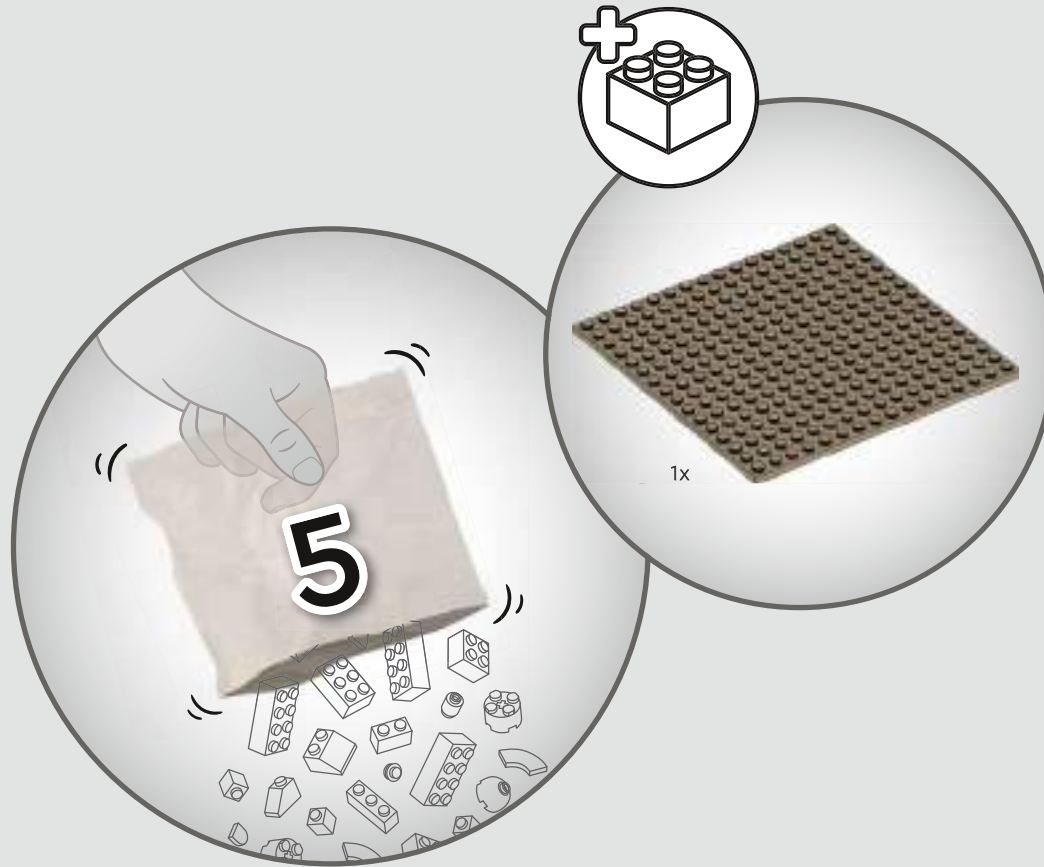



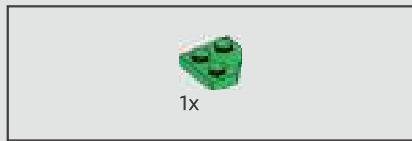
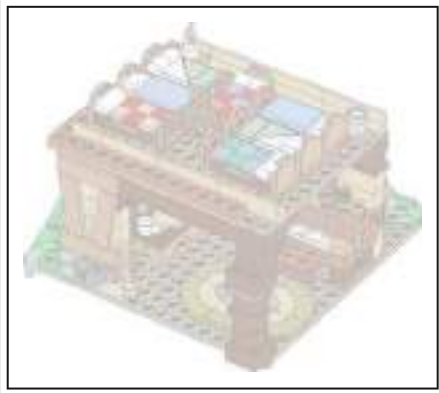

116

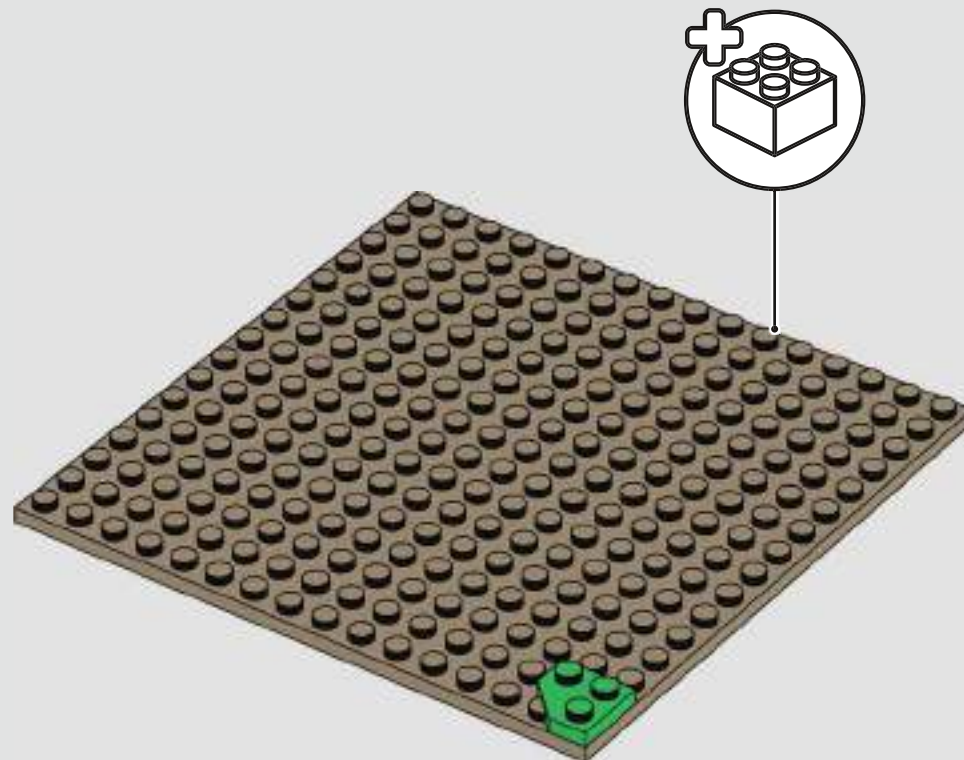



117

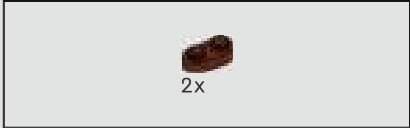
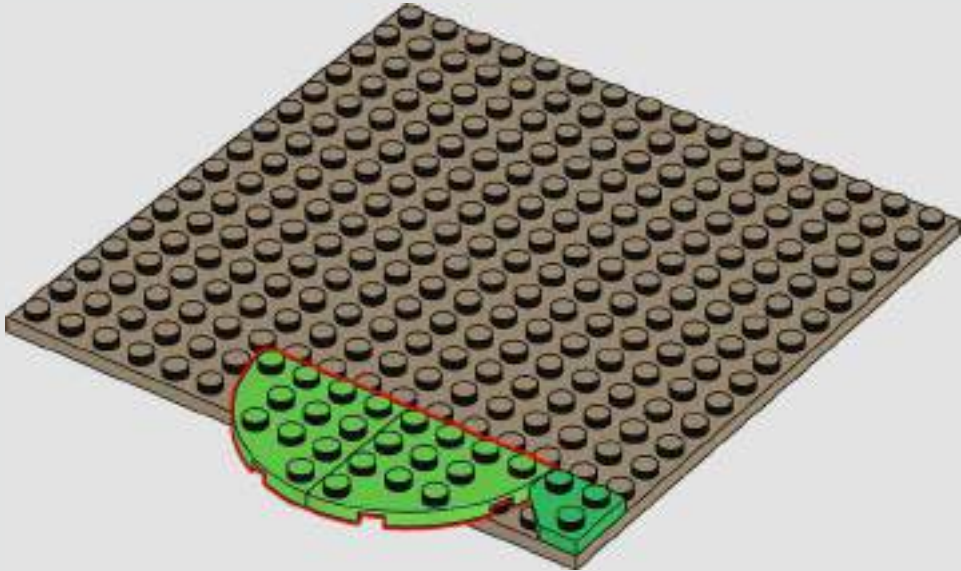

118

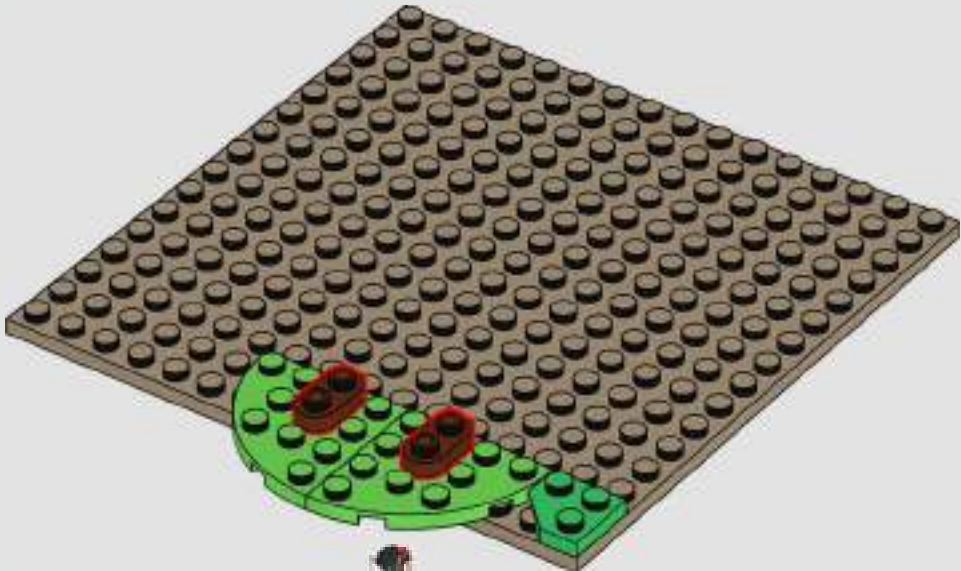





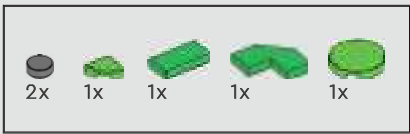

121

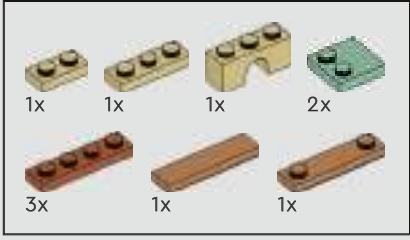
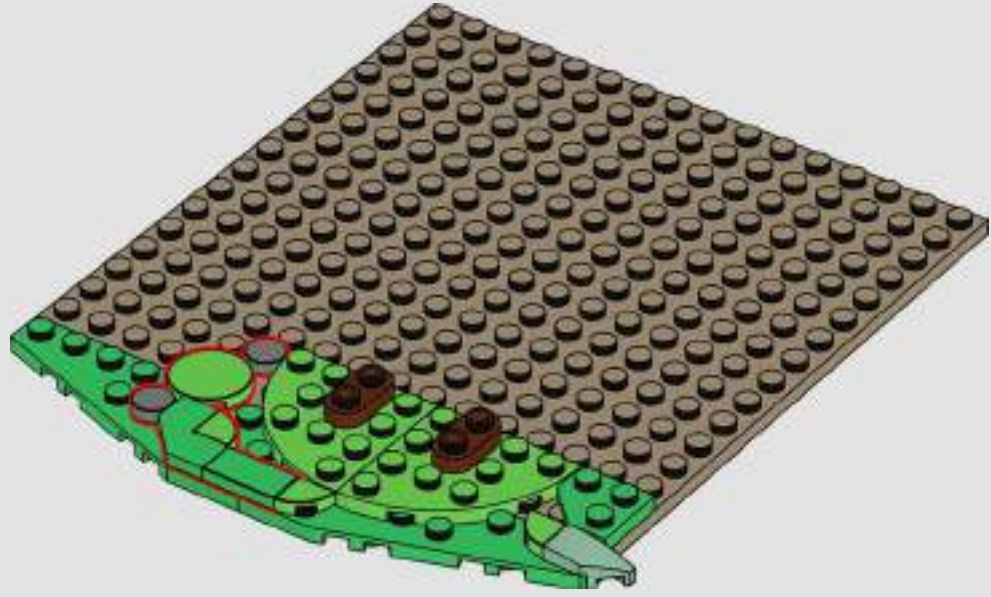

122

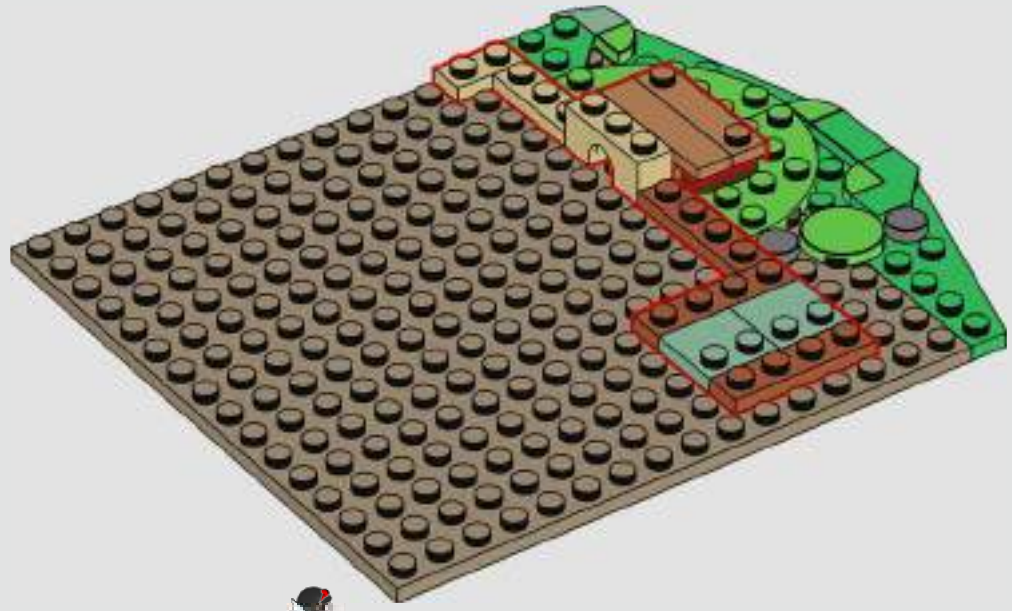





123

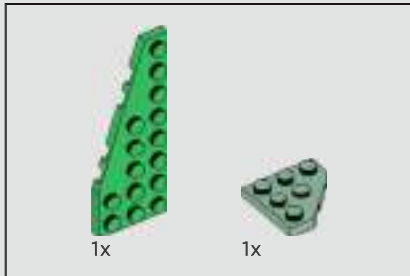
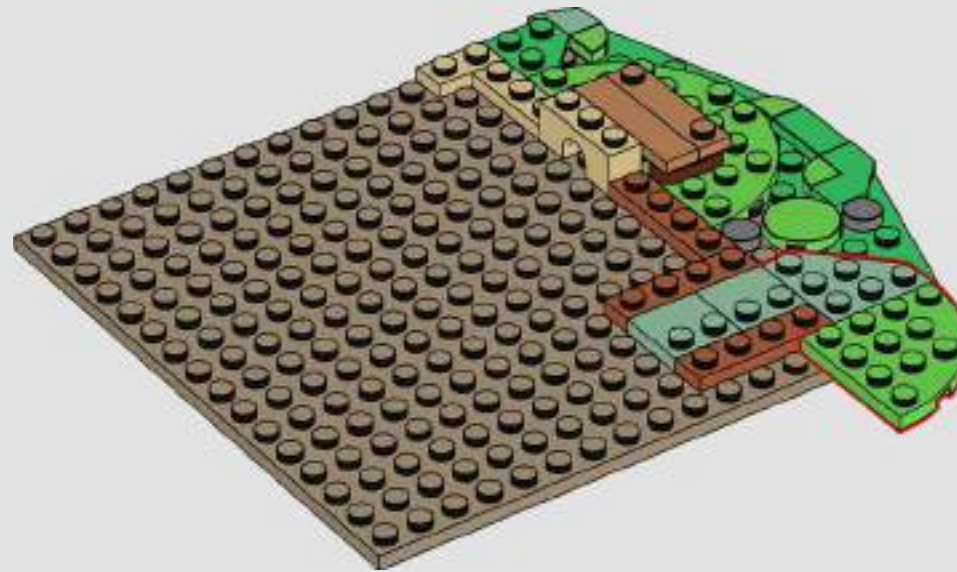

124

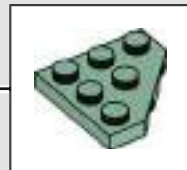
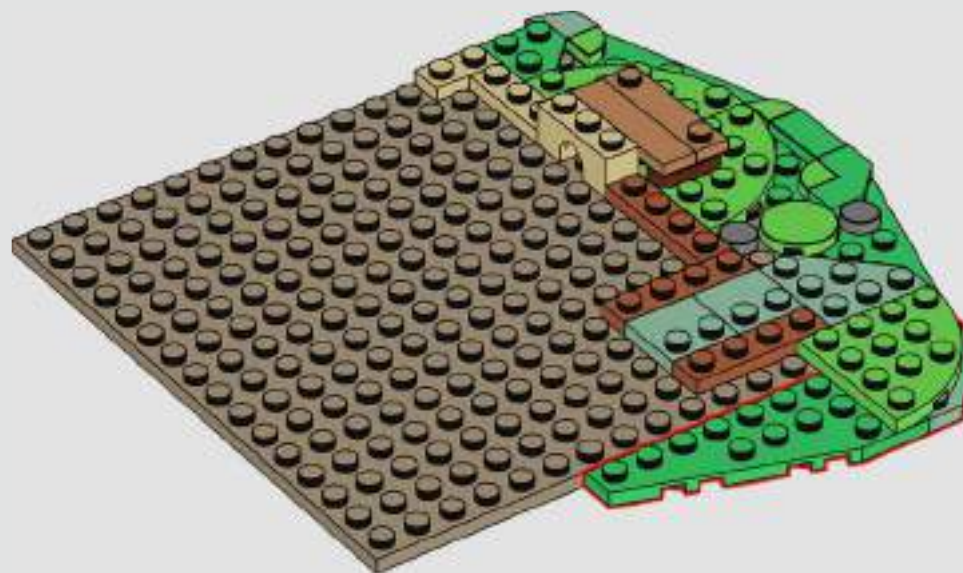



125

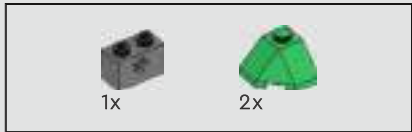
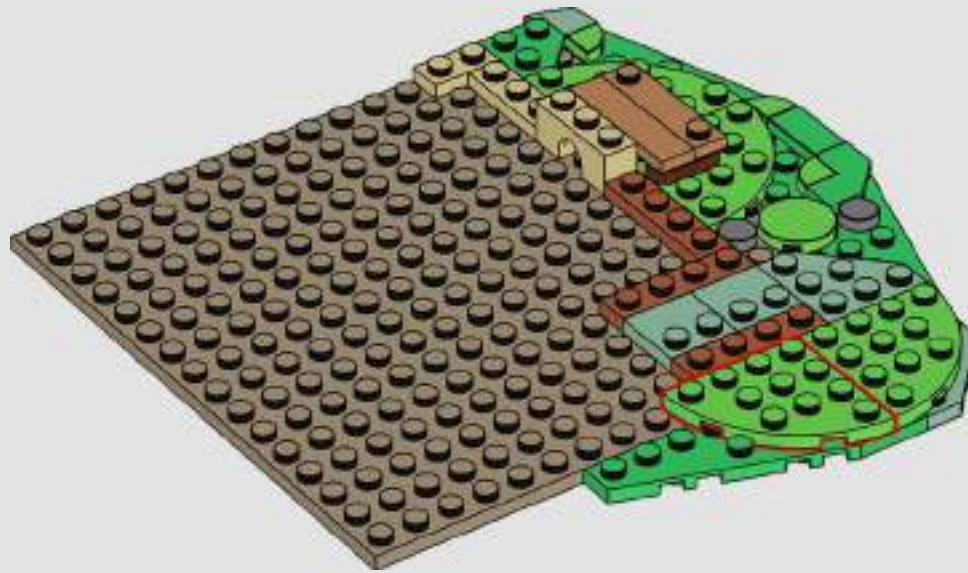

126

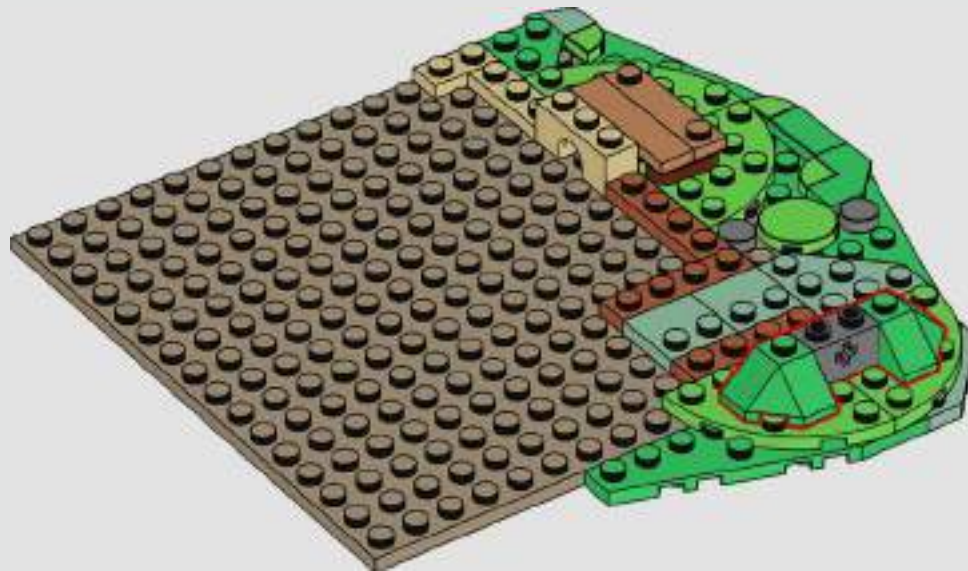

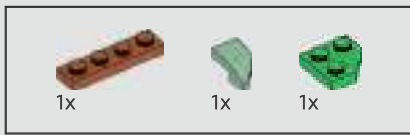

127

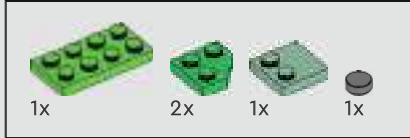
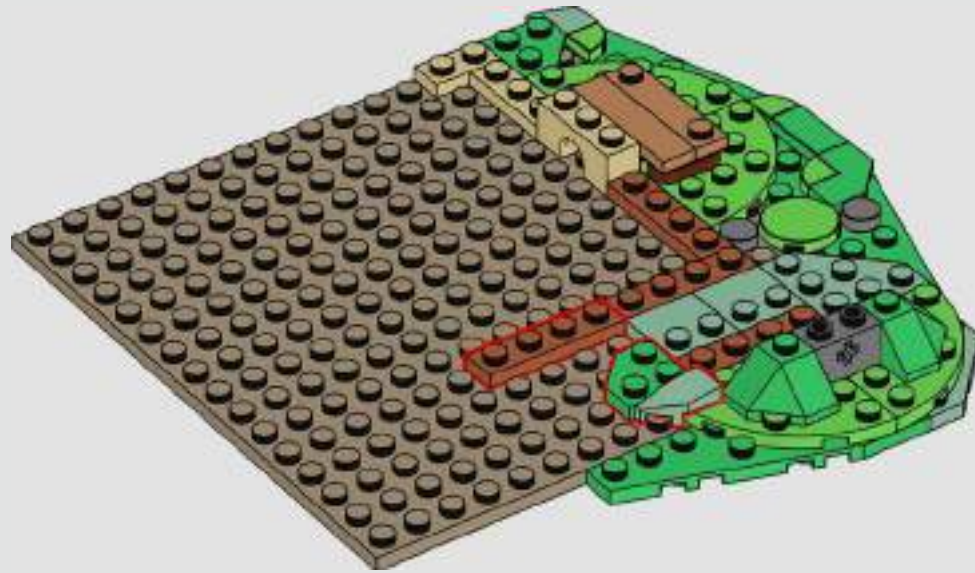

128





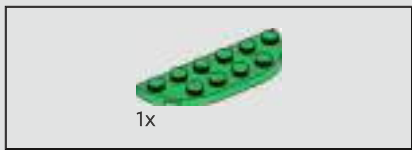

129

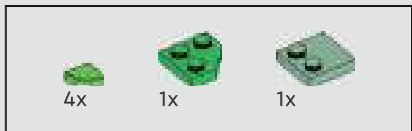
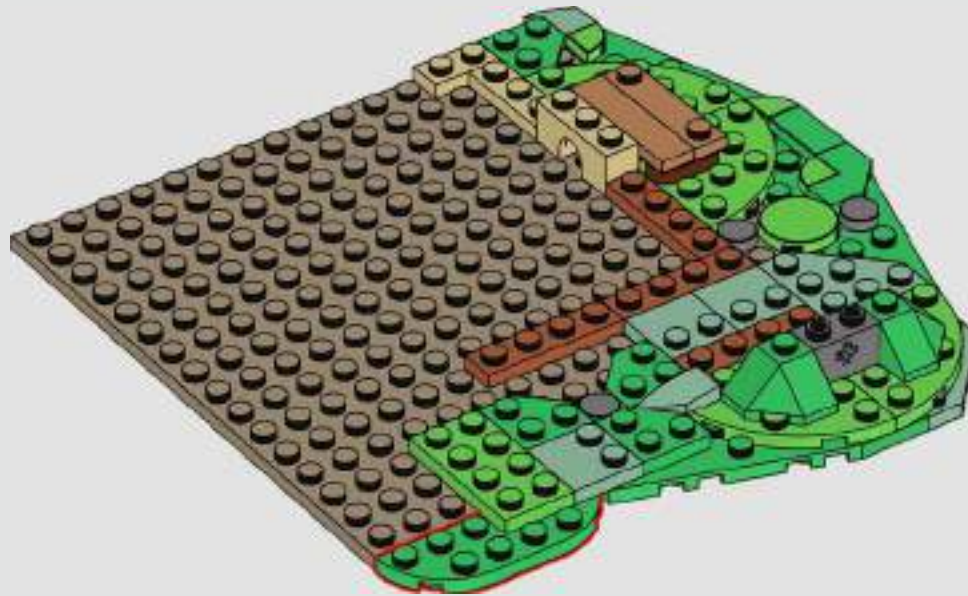

130



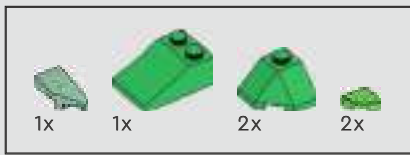

131



132

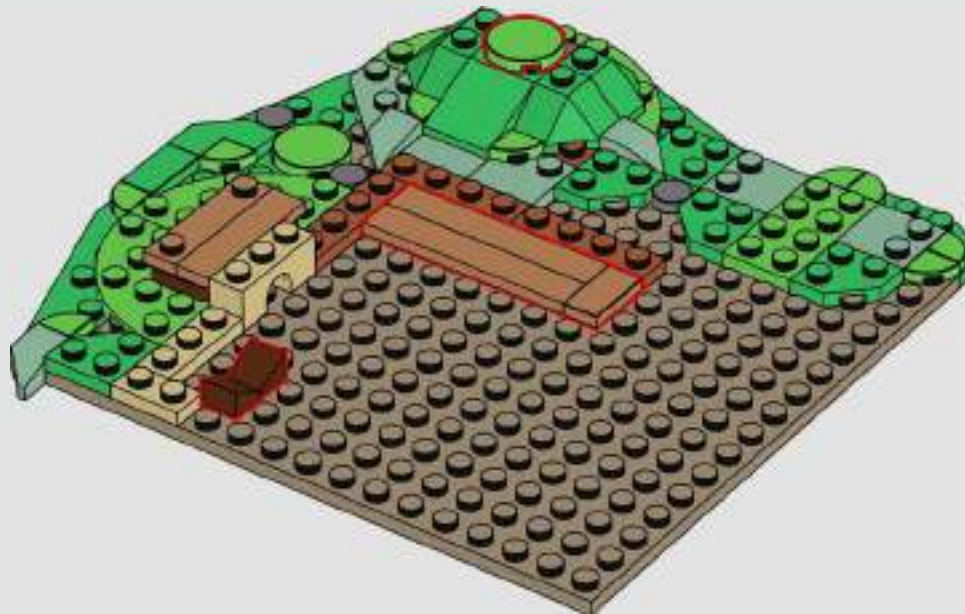



133

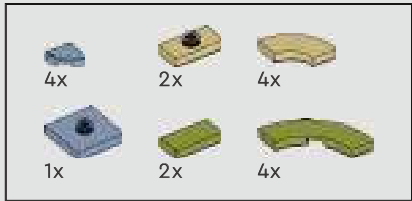

134





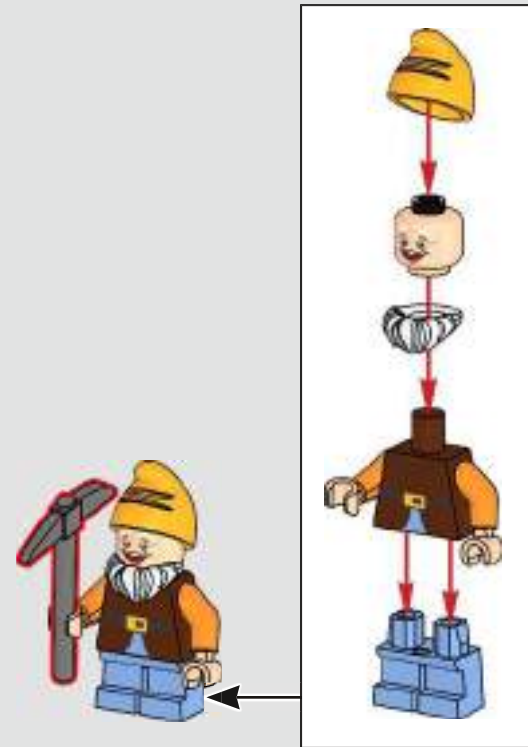

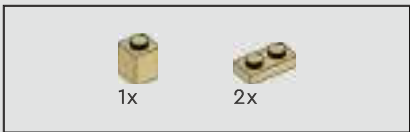

135

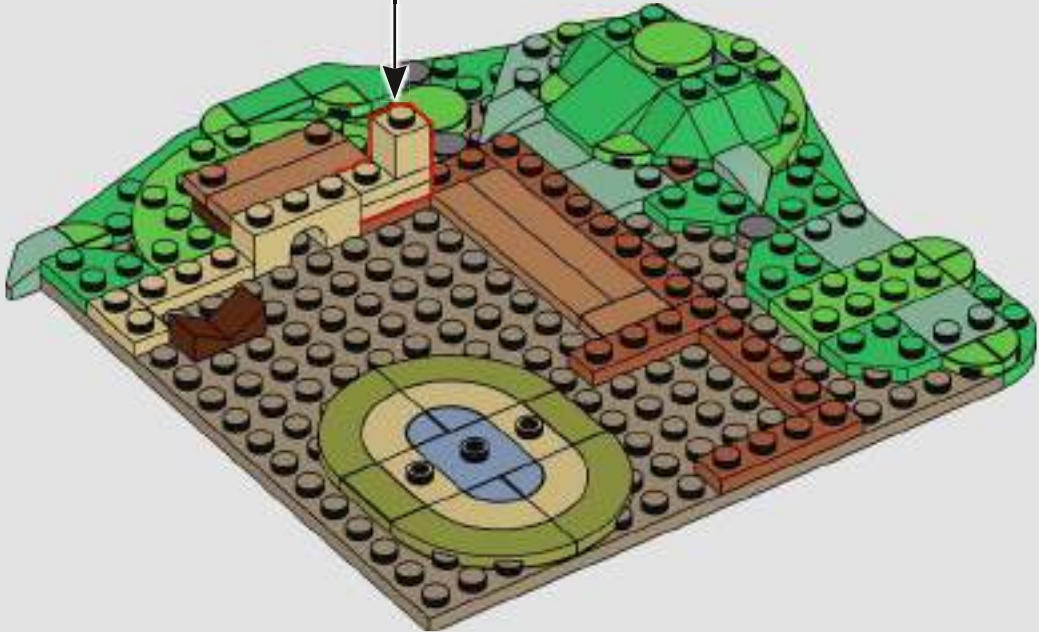
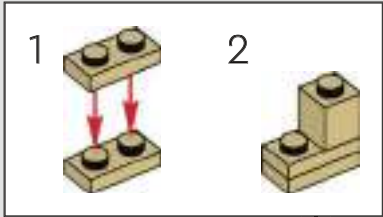



136



137







138

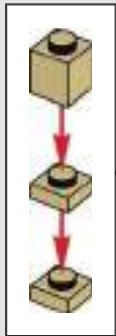
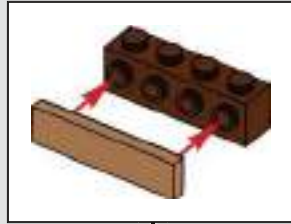



139

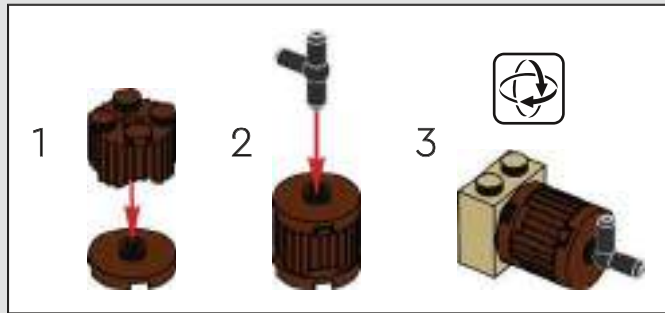



140

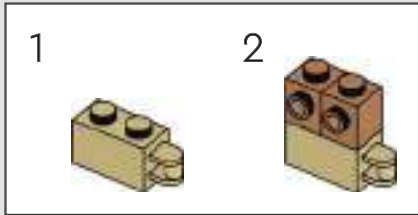
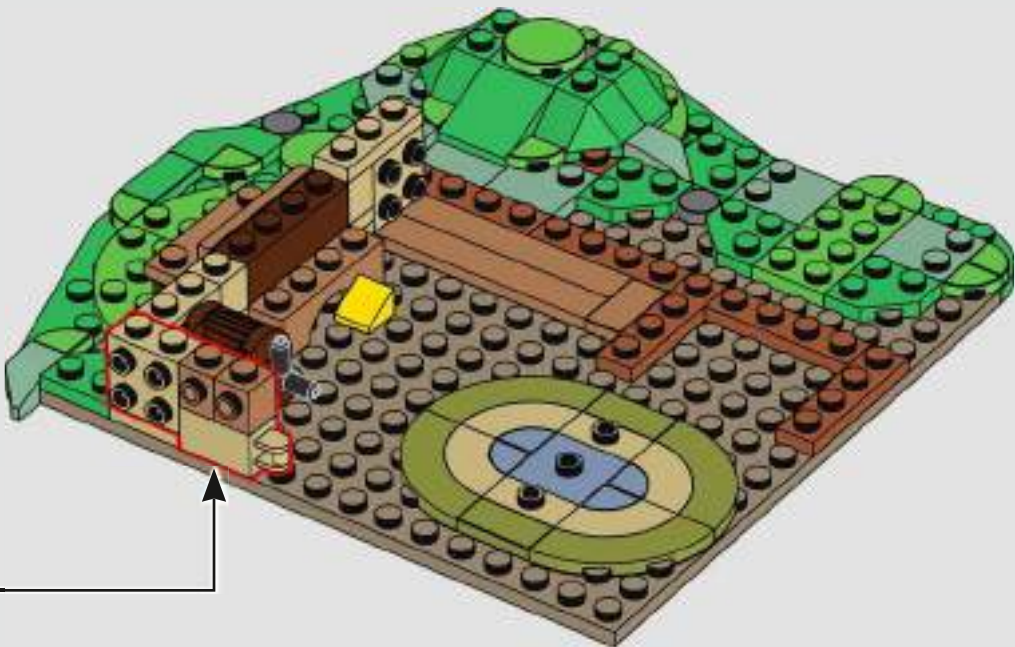

141





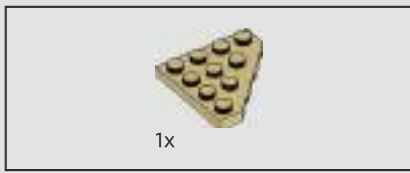

142



143



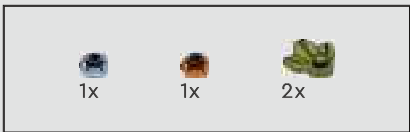

144





145

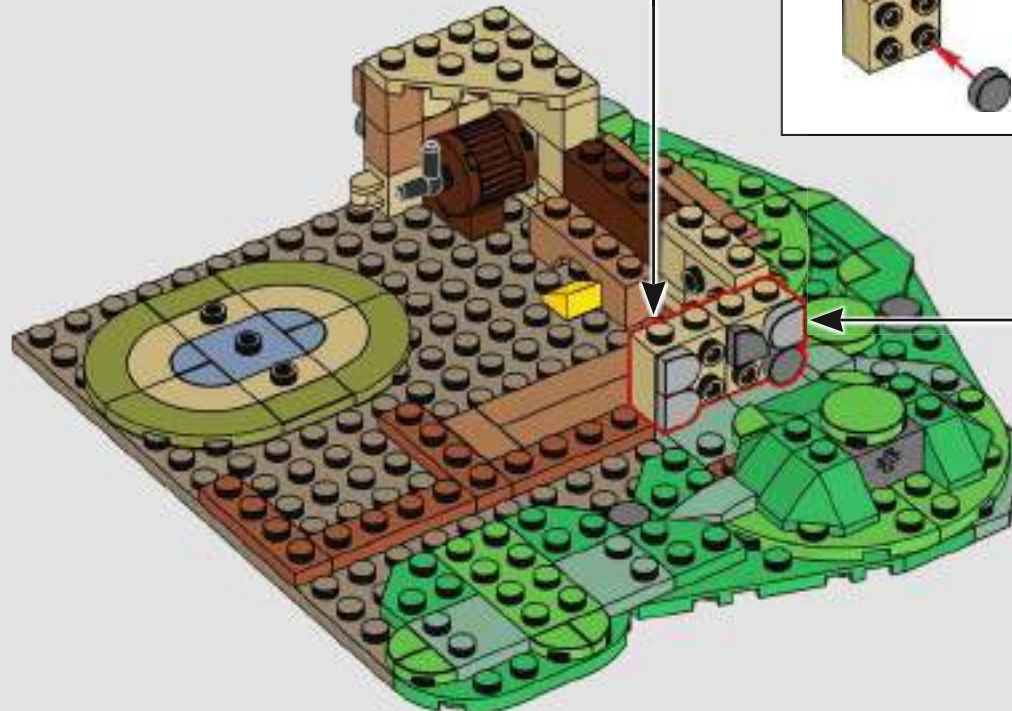
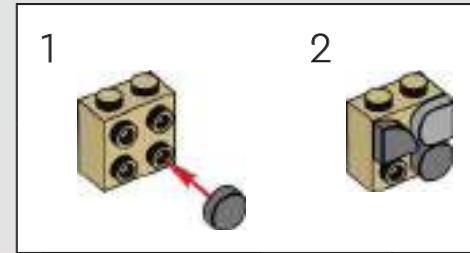
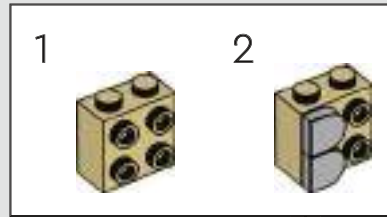



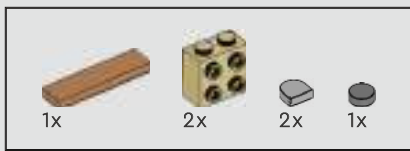

146

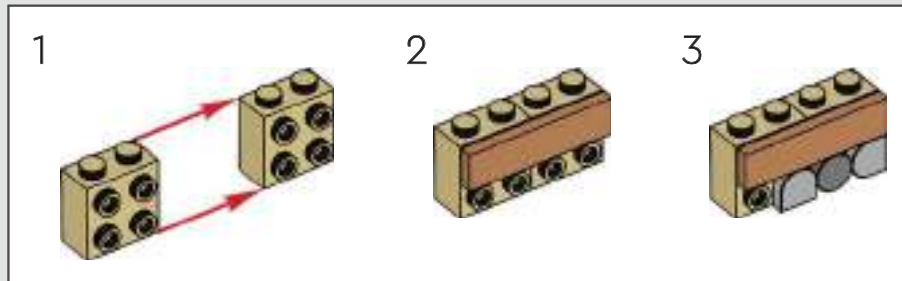

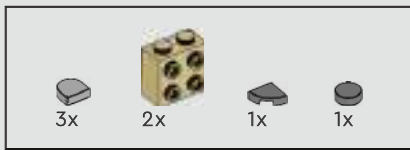

147

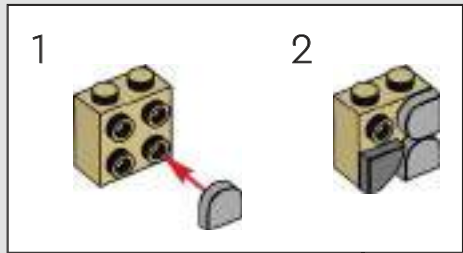
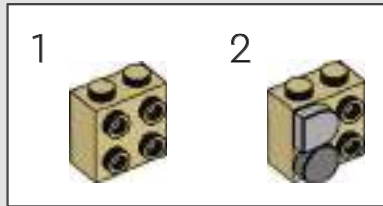



148







149

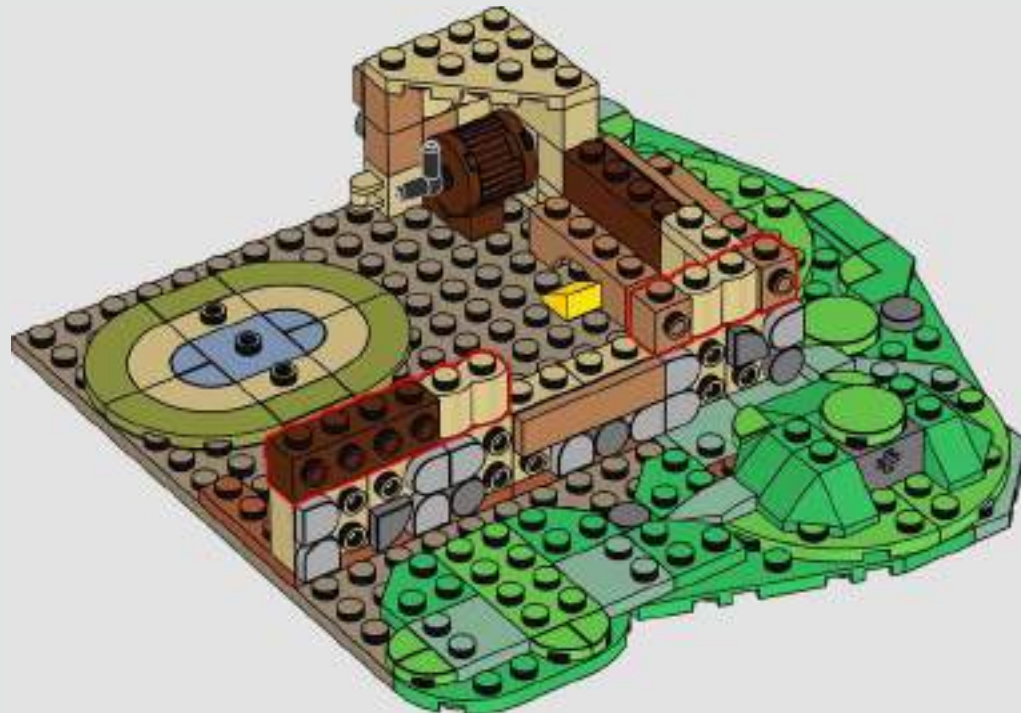

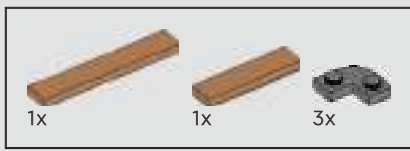

150

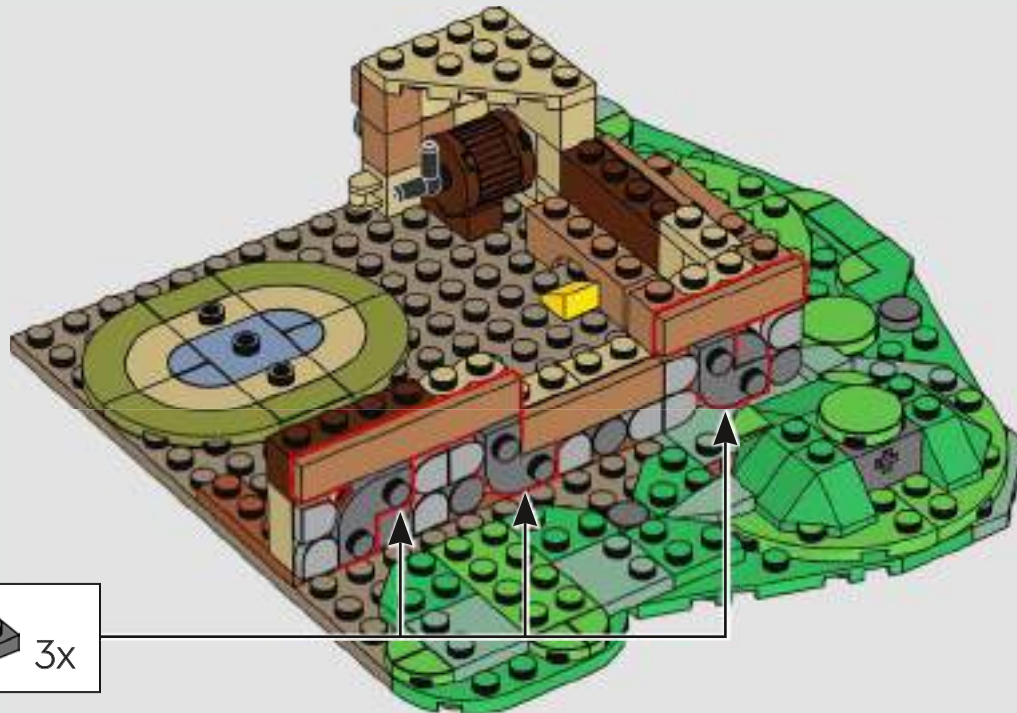

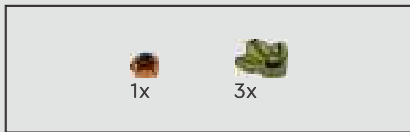

151





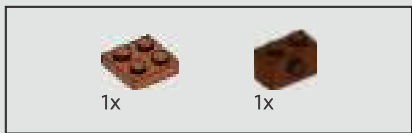

152





153

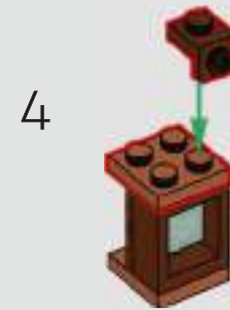







154



155





2x

156



2x



1x



1x



1x

157





158



159





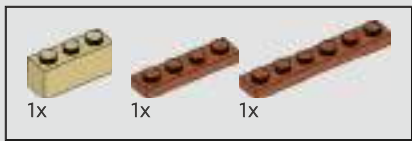

160

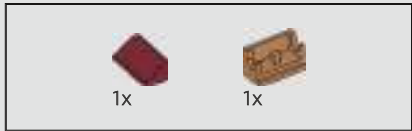

161





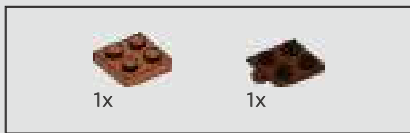

162

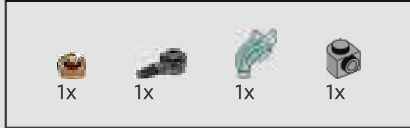

163

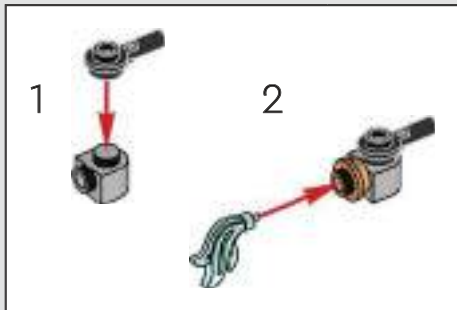



164

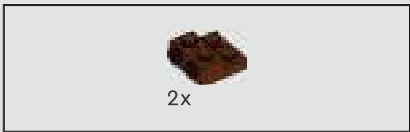
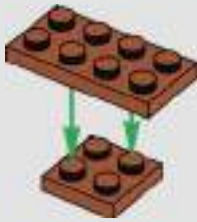

165



166

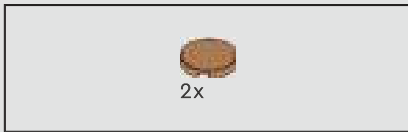
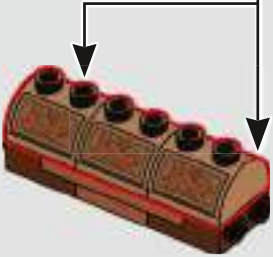
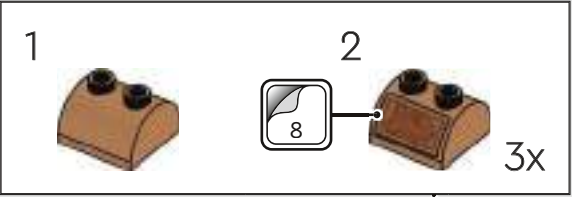

167



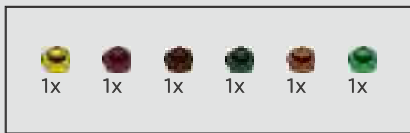

168



169

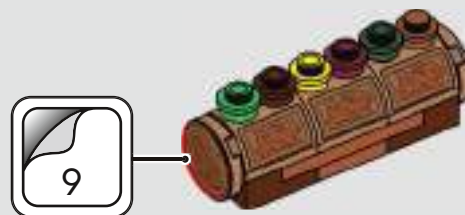



170





171

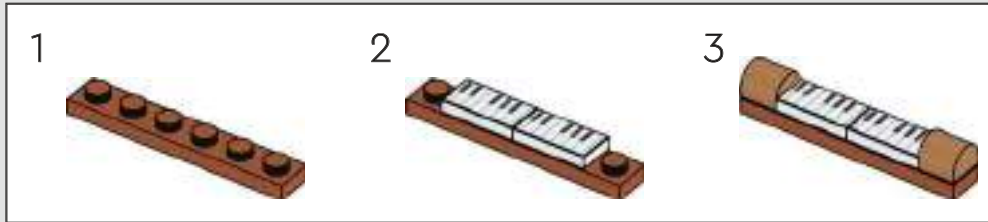

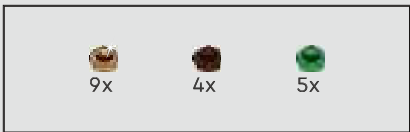

172

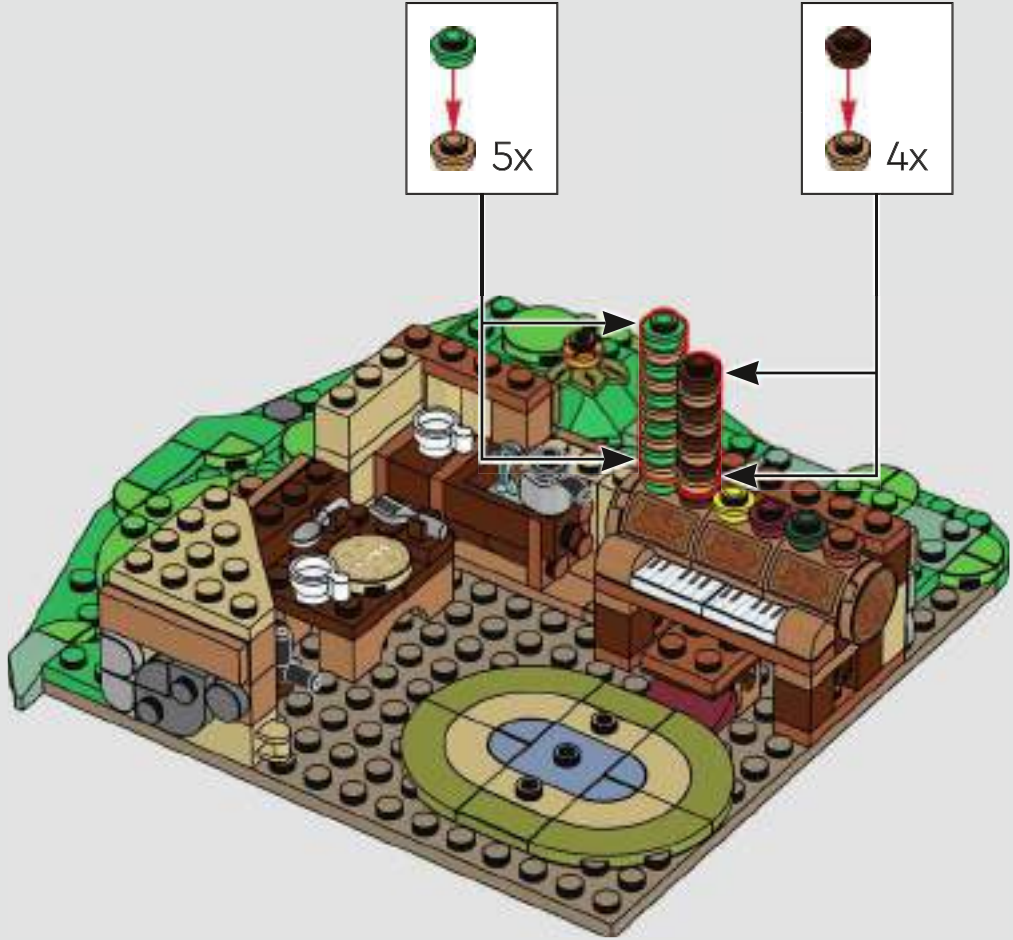



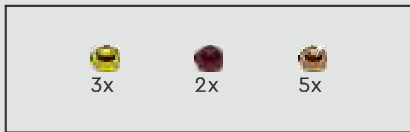

173

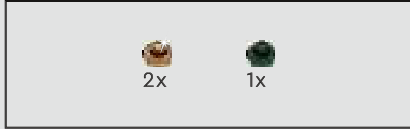

174



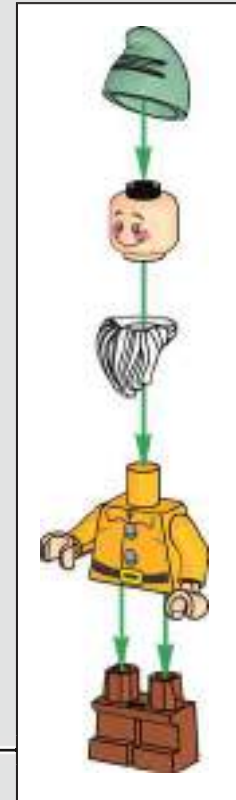



175



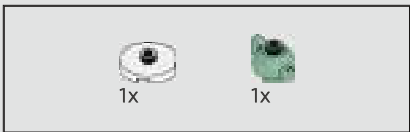

176







5x

177





178



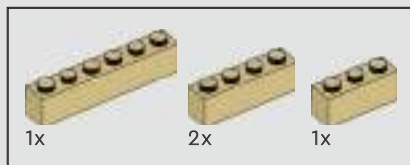

179



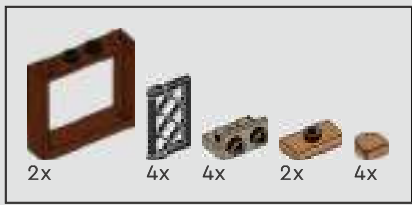

180

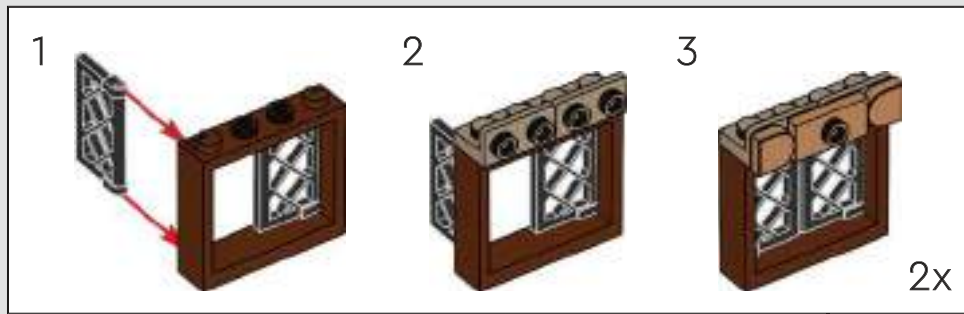



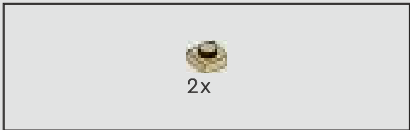

181



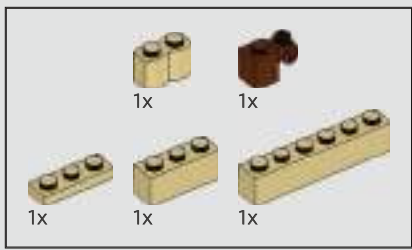

182





183



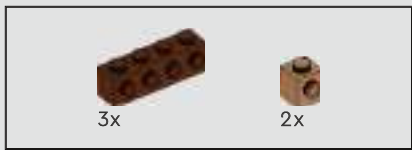

184





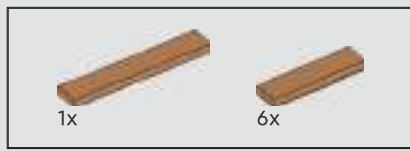

185



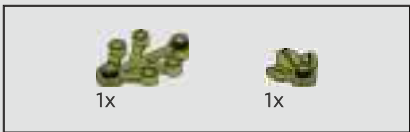

186

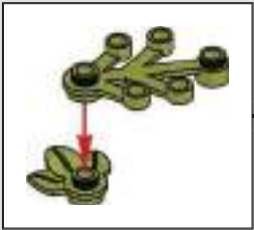



187





188

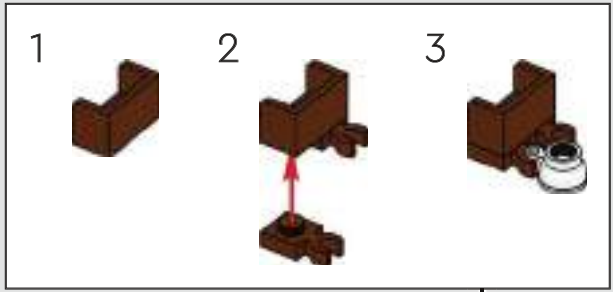





189

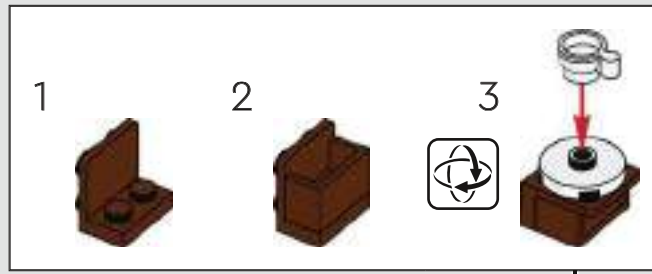



190





191

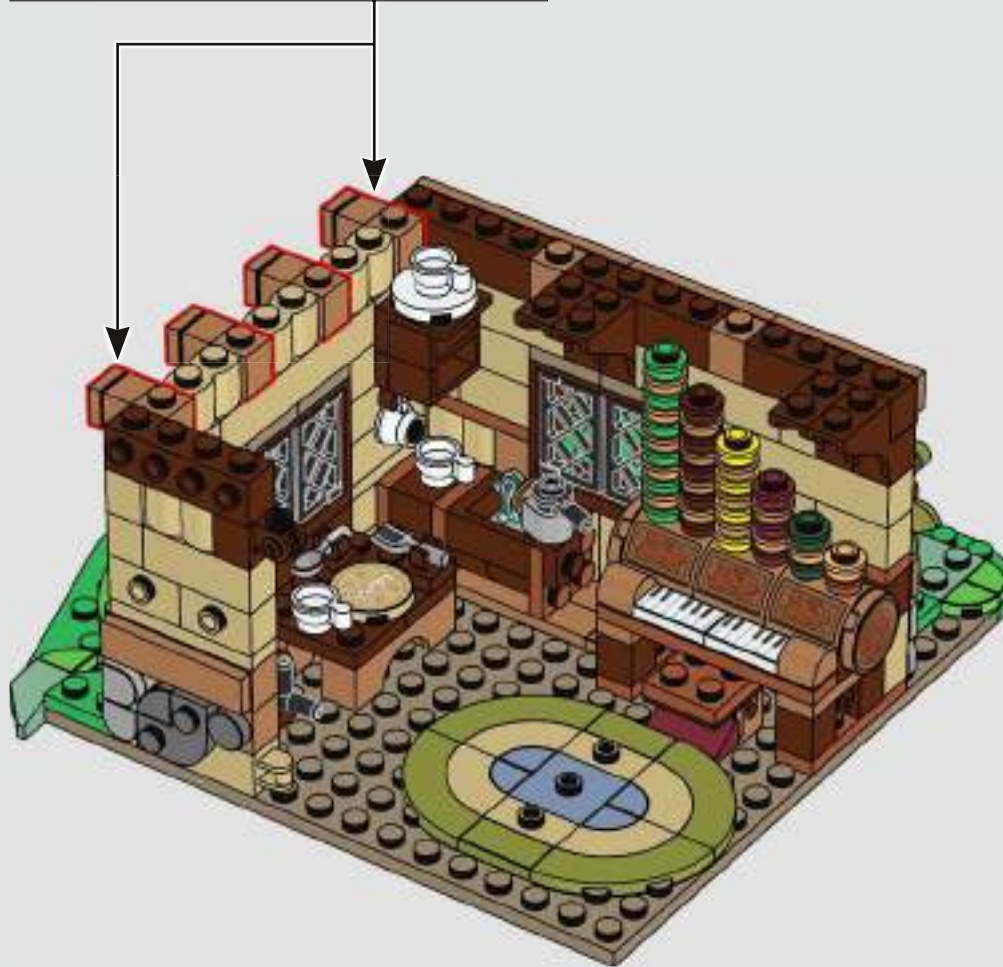
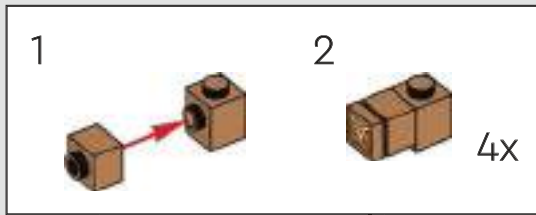

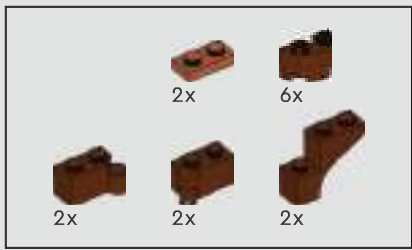

192

1



2



3



4

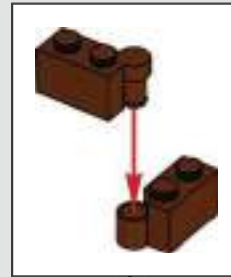

5

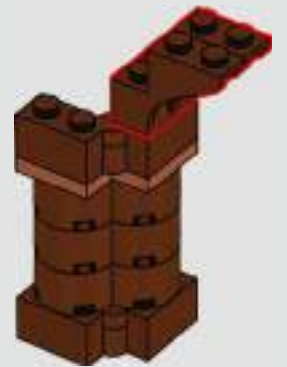





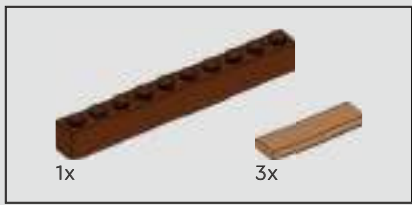

193



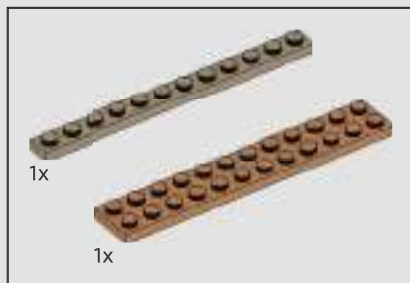

194





195





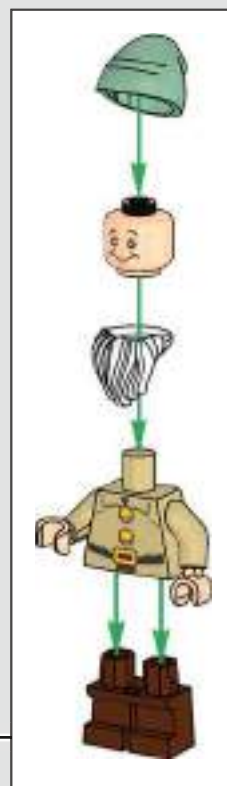

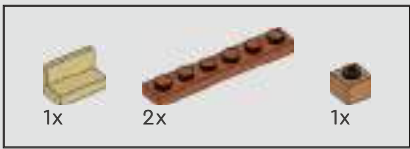

196





197





198





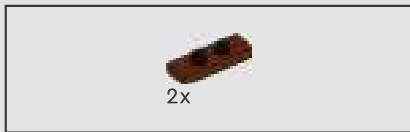

199



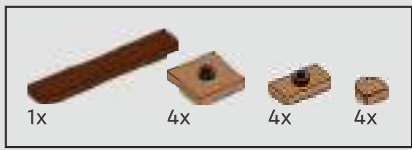

200



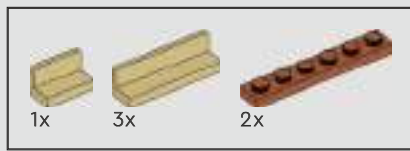

201



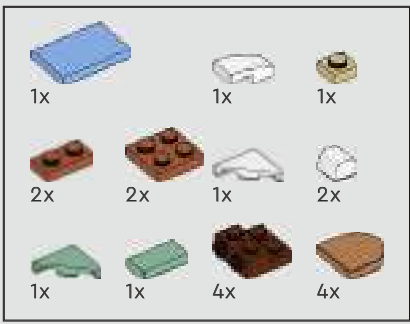

# 202

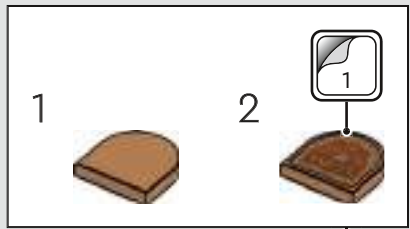
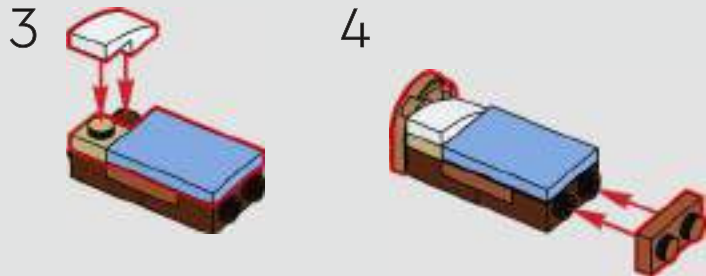
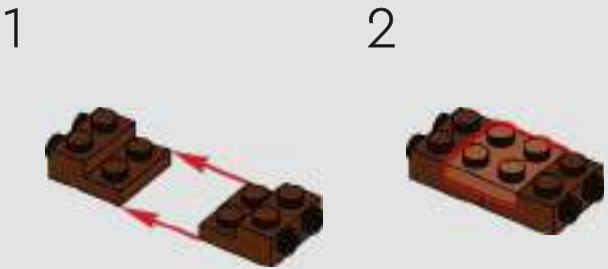
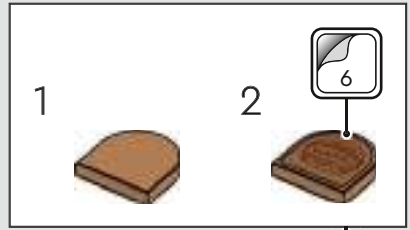
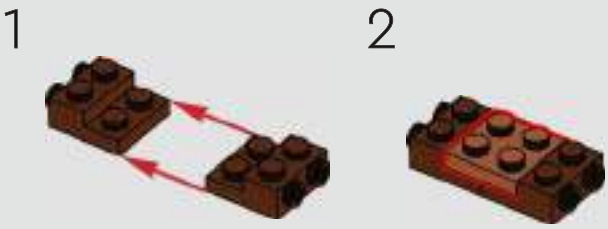



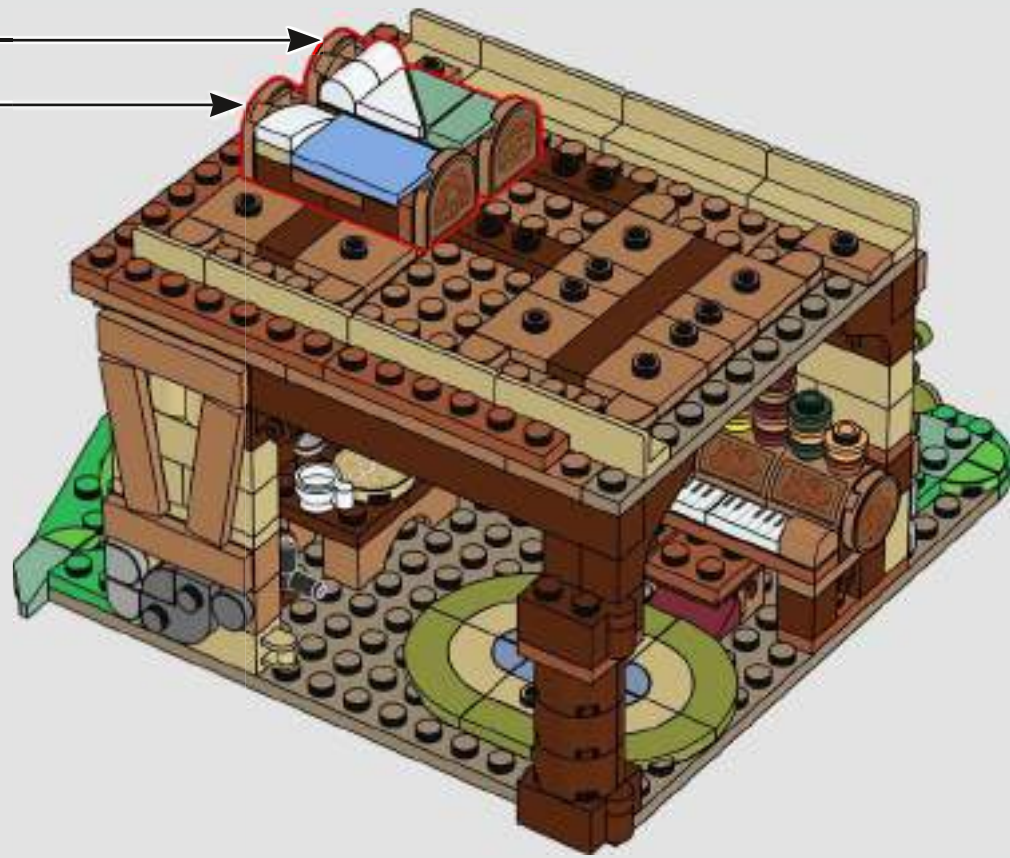



# 203

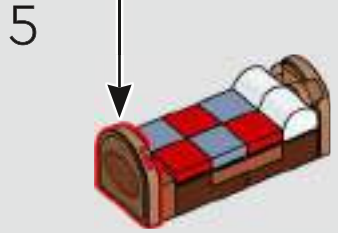
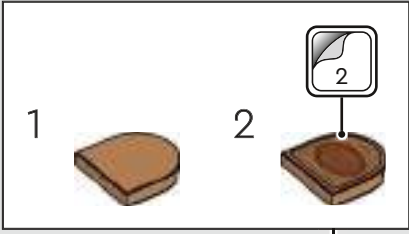
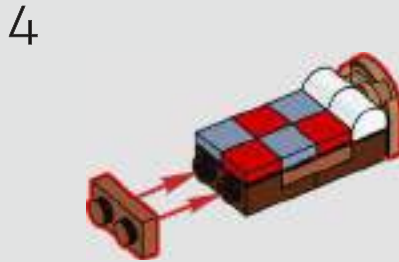
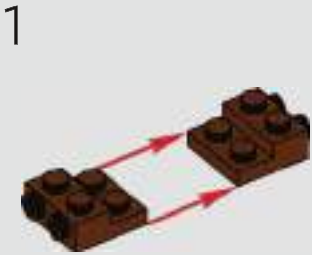
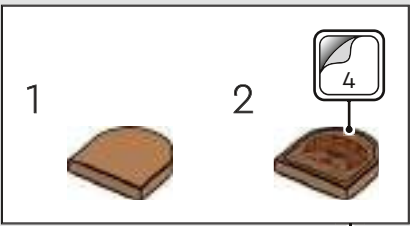

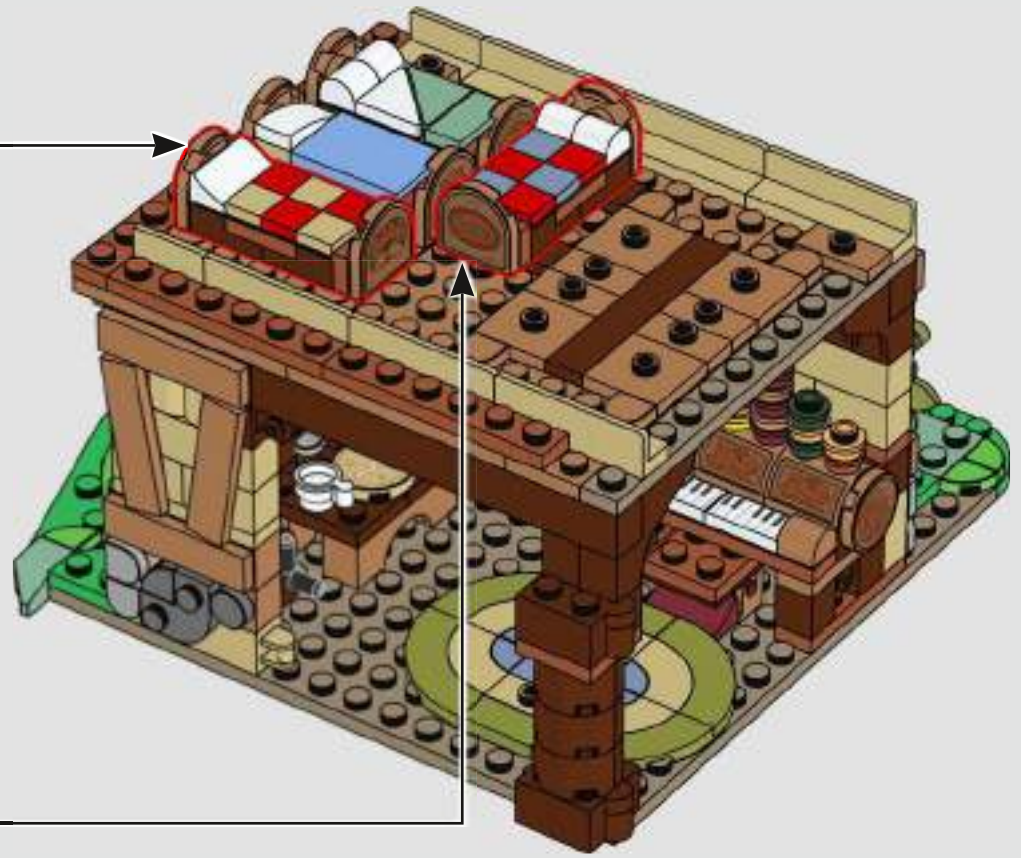

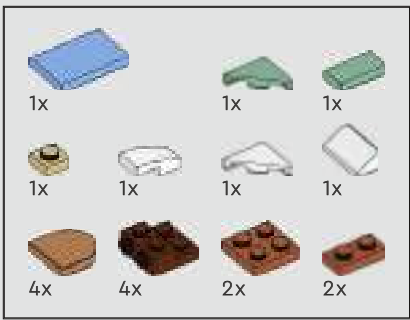

204

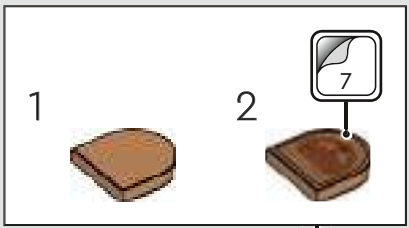
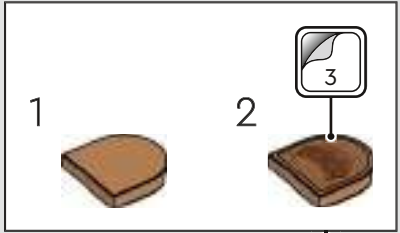
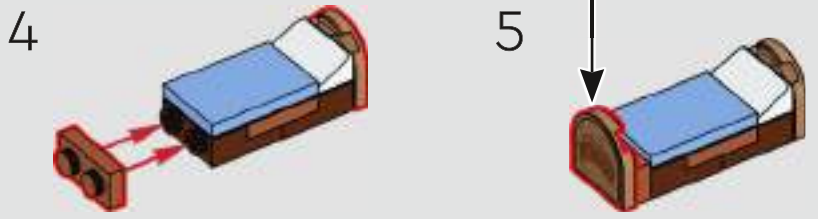



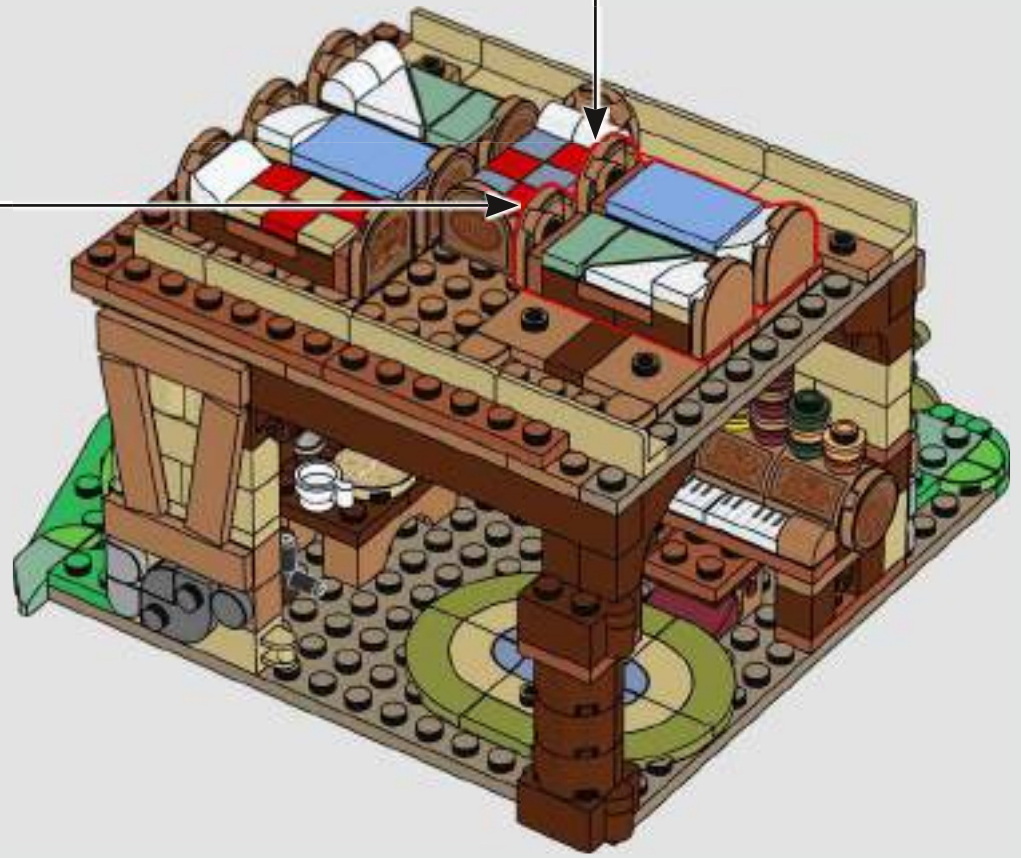



205

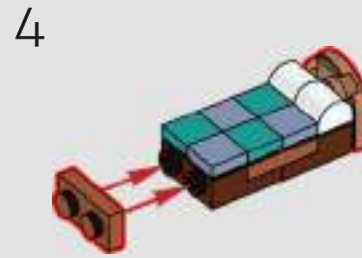
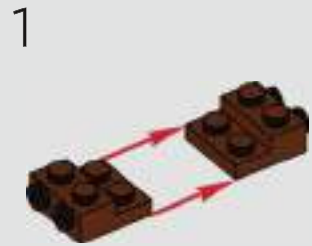

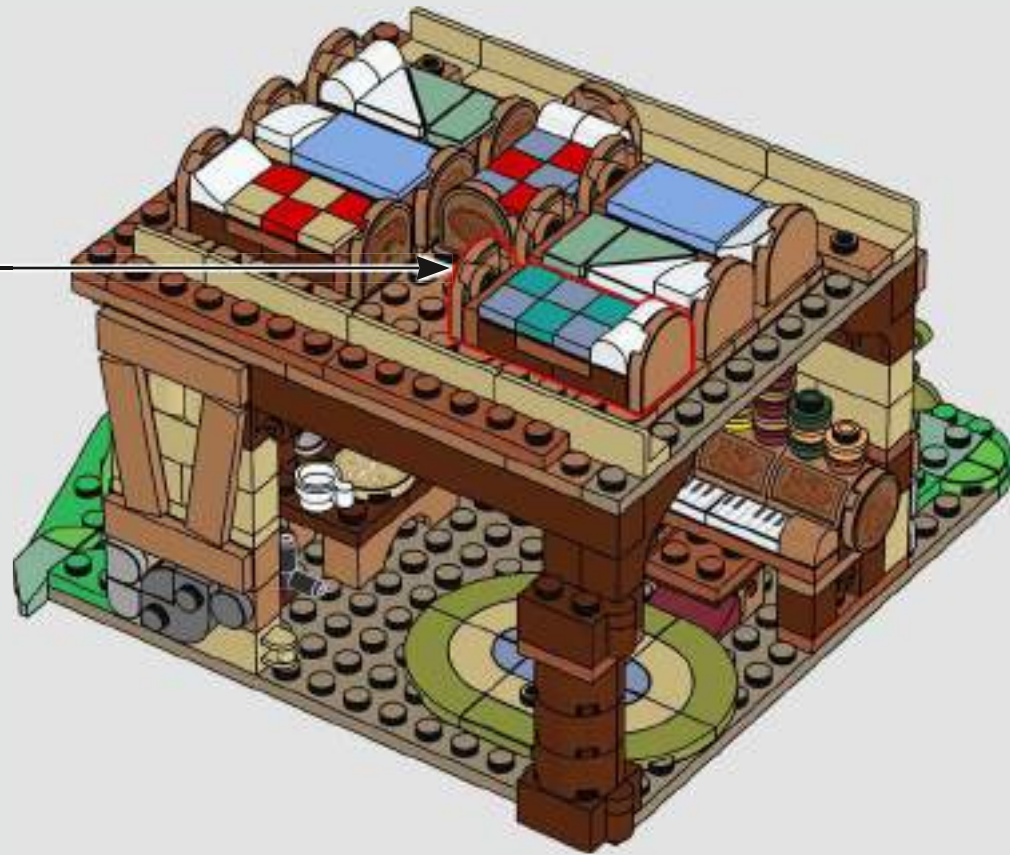

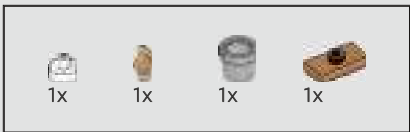

206

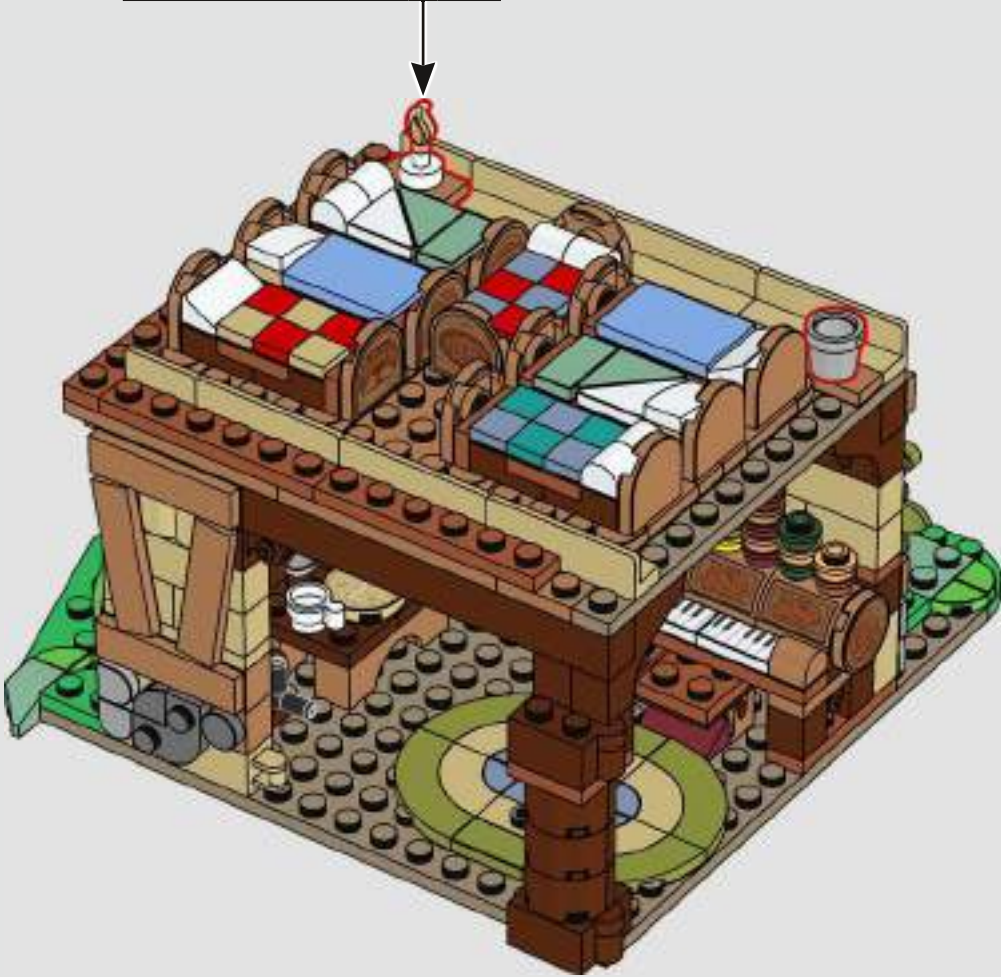
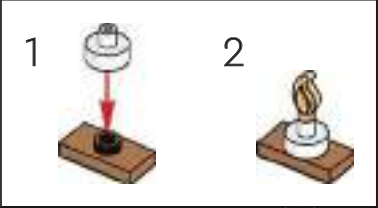



207

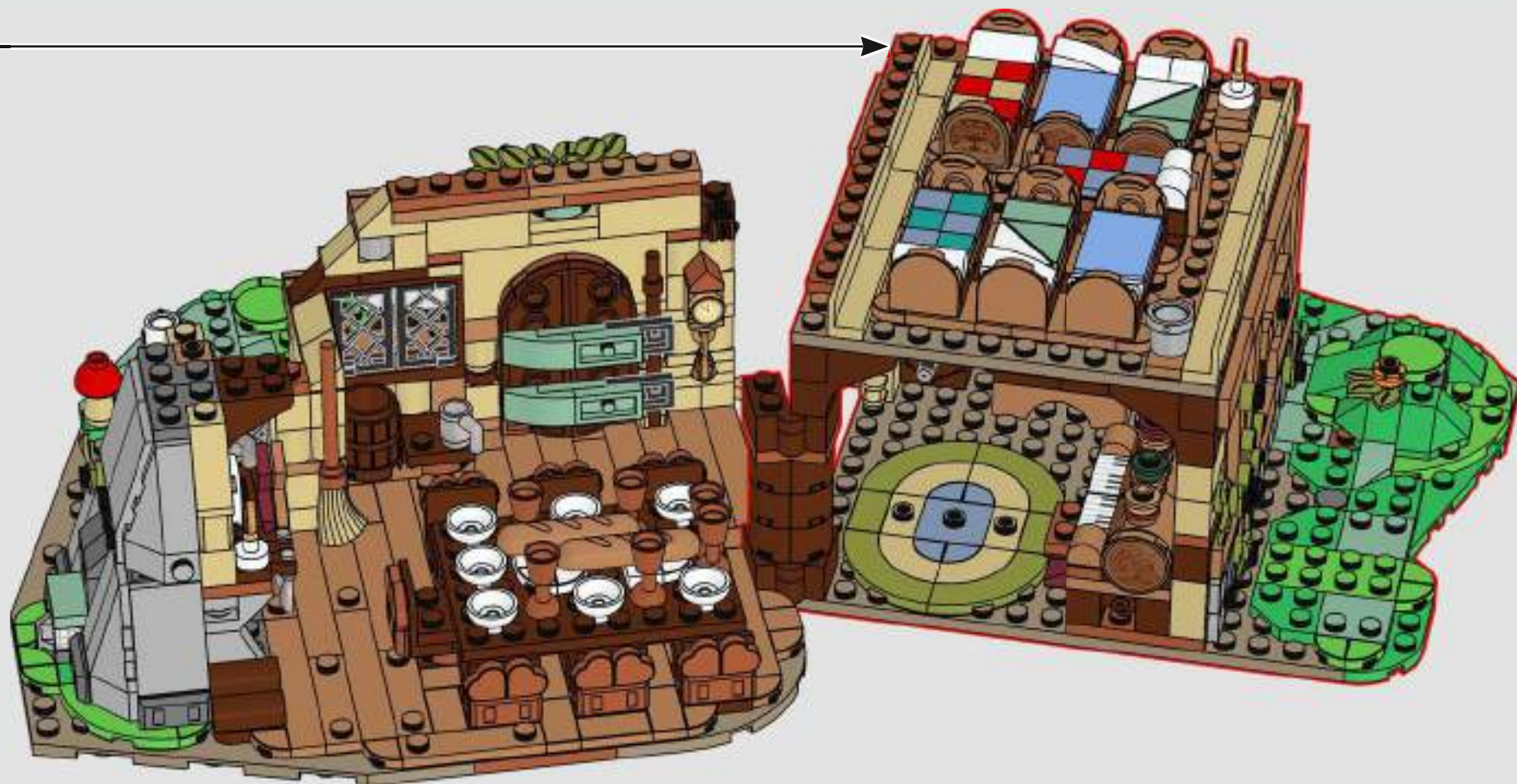



208





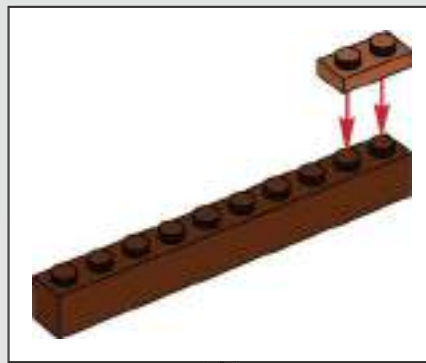
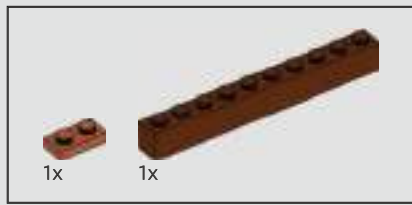

209



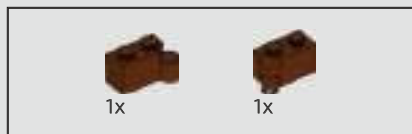

210

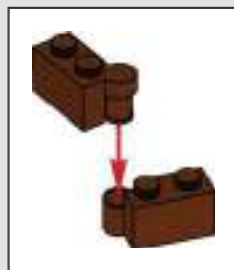





211

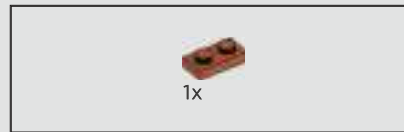

212

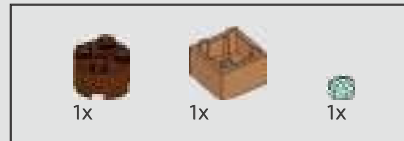
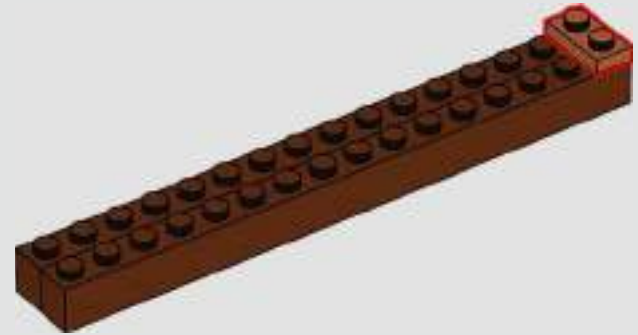

213

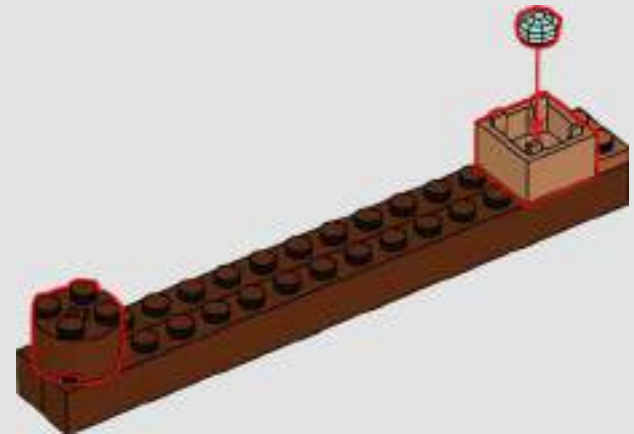



214

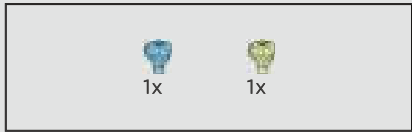
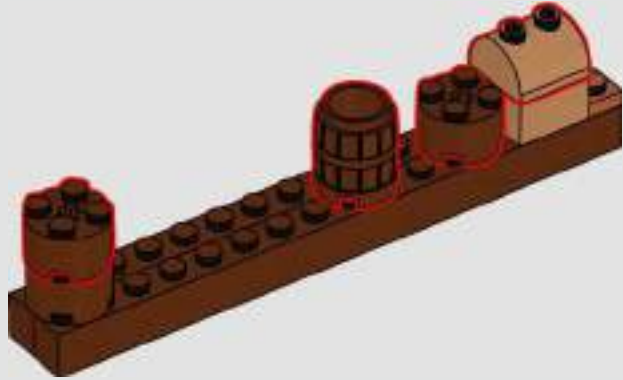

215

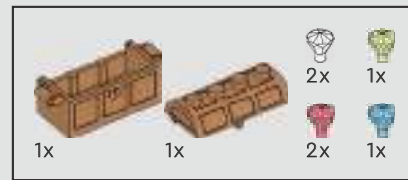
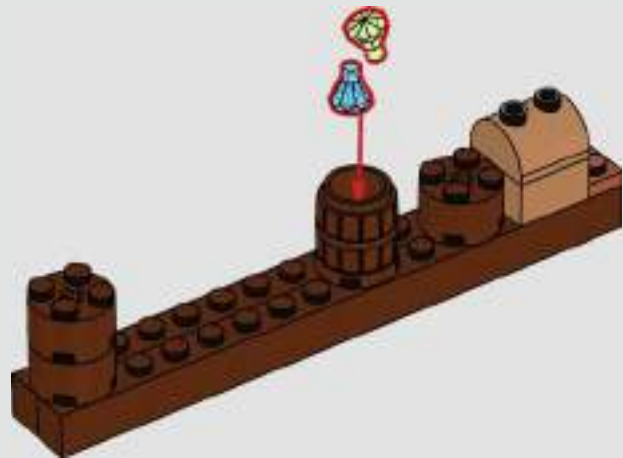

216

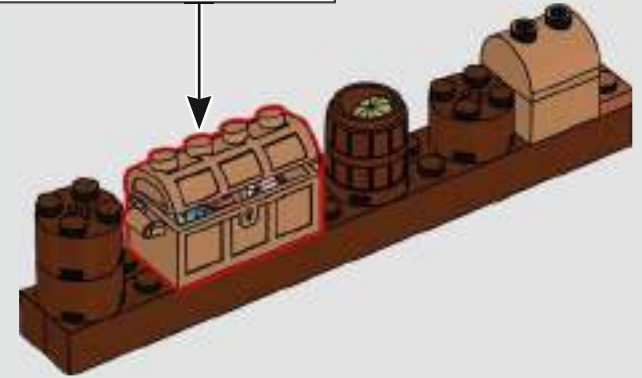
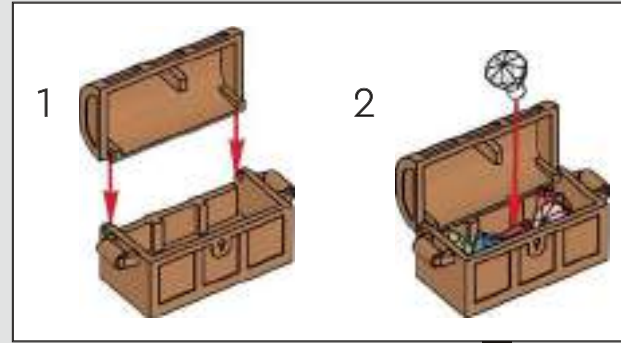

217





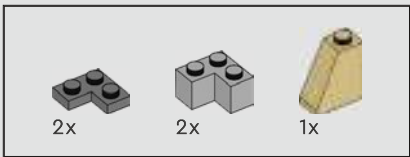

218

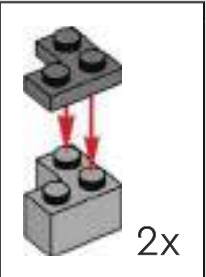



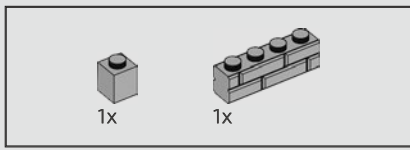

219



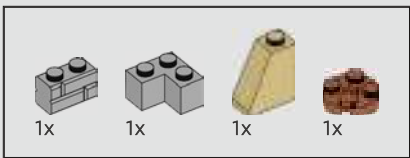

220





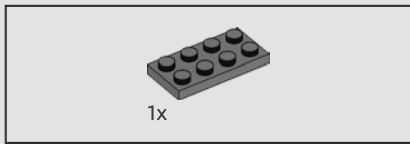

221





2x

222



2x





223





2x

224







225







2x

226





227

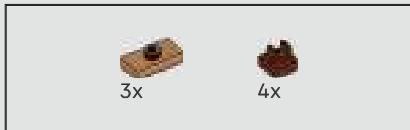

228



229

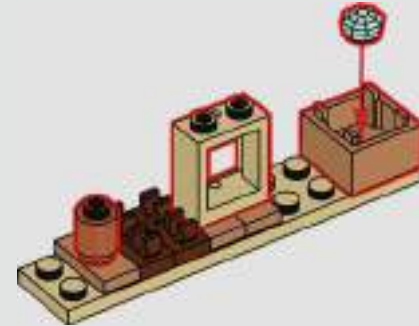

230

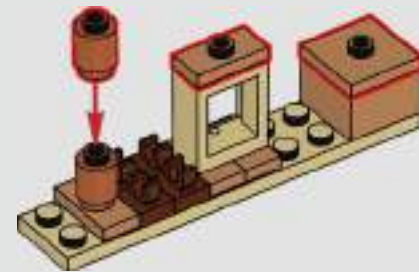









232



233

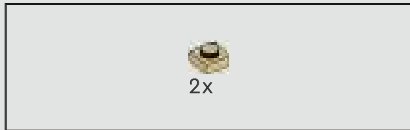
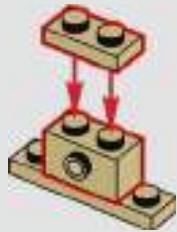

234

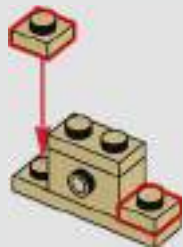

235

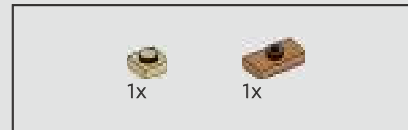

236







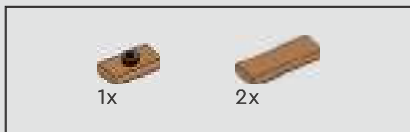

238







239

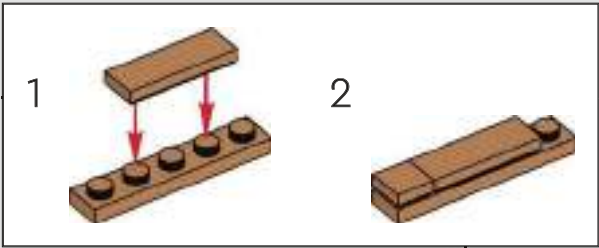



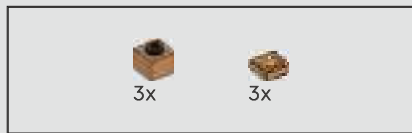

240



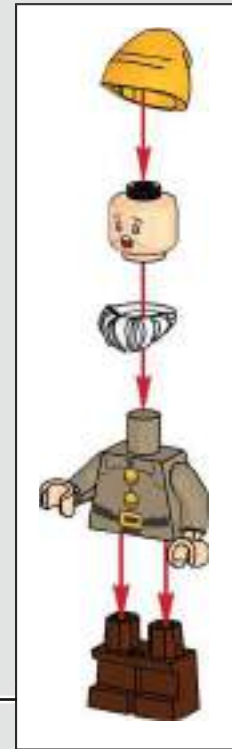



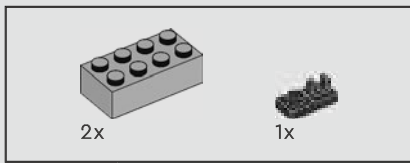

241

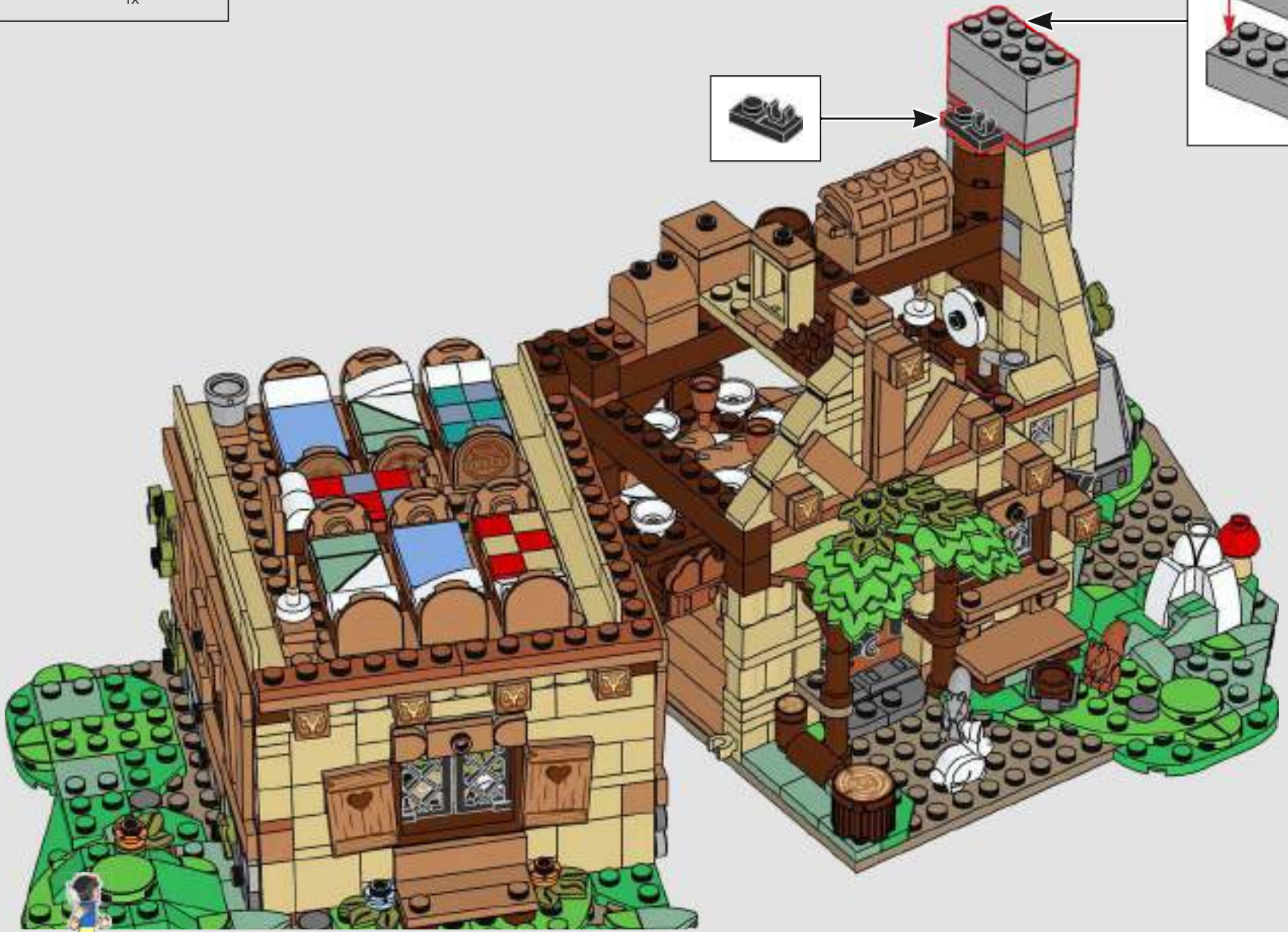
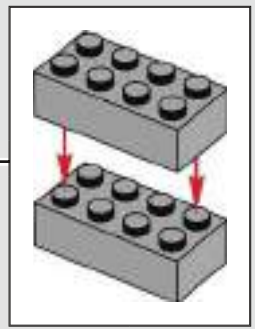





242





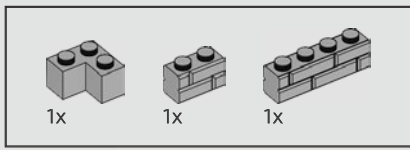

243







244





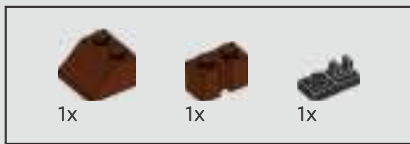

245

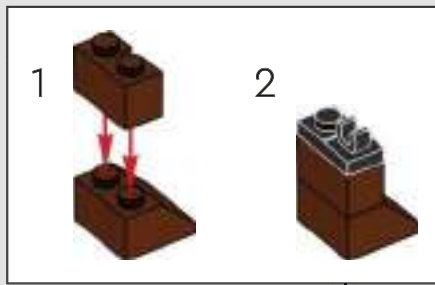



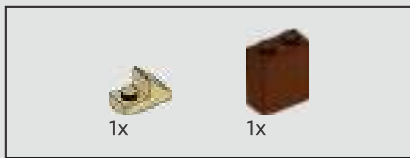

246

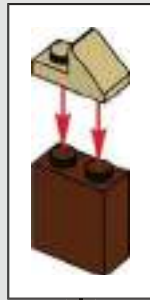



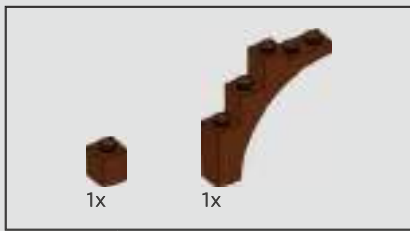

247





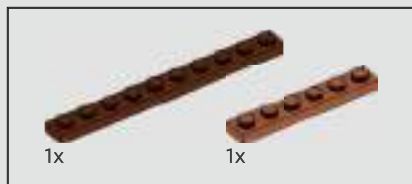

248

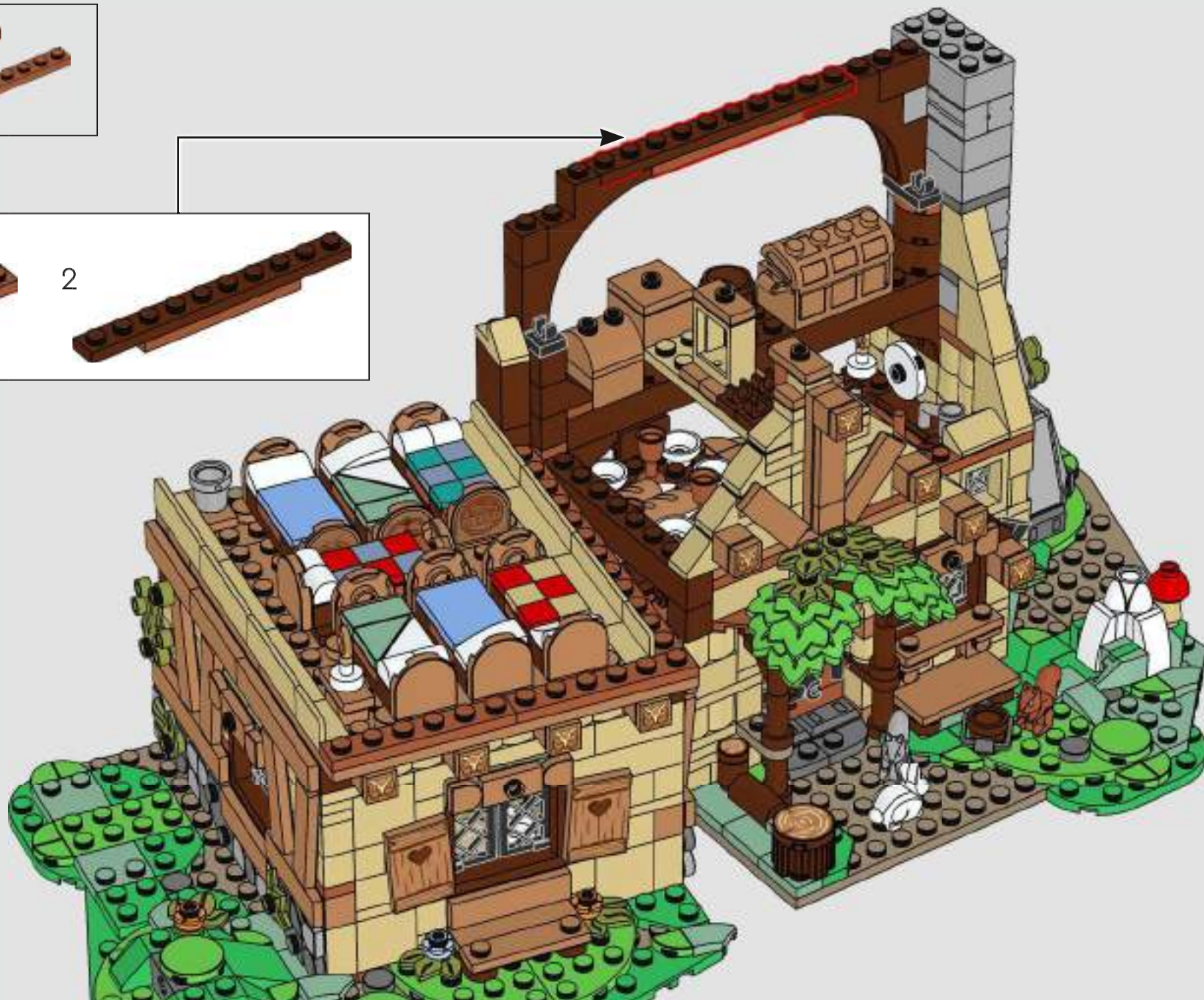
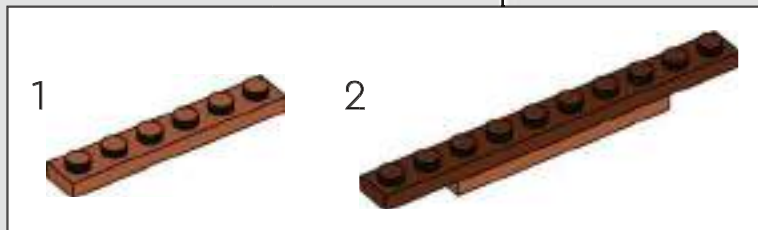



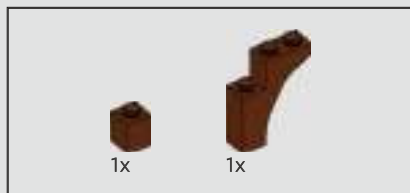

249





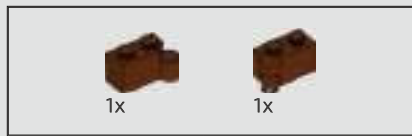

250



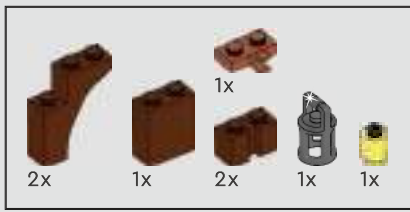

251

1

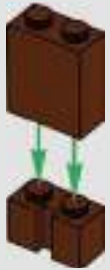

2



3

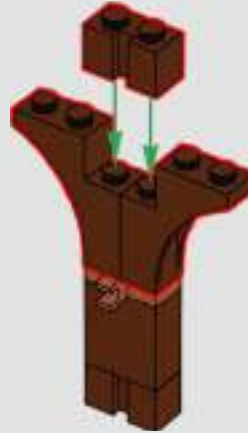

4

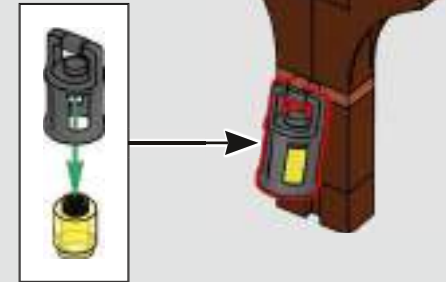









252





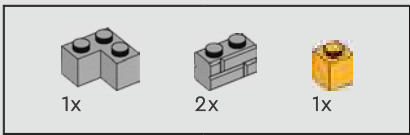

253





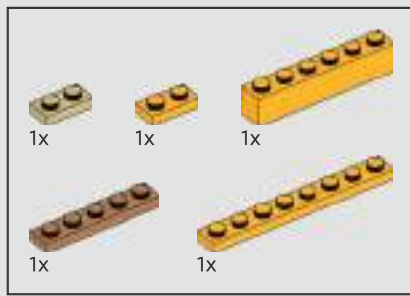

254





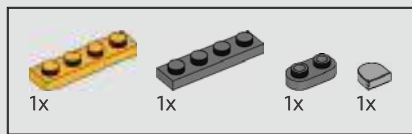

255





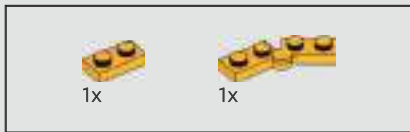

256

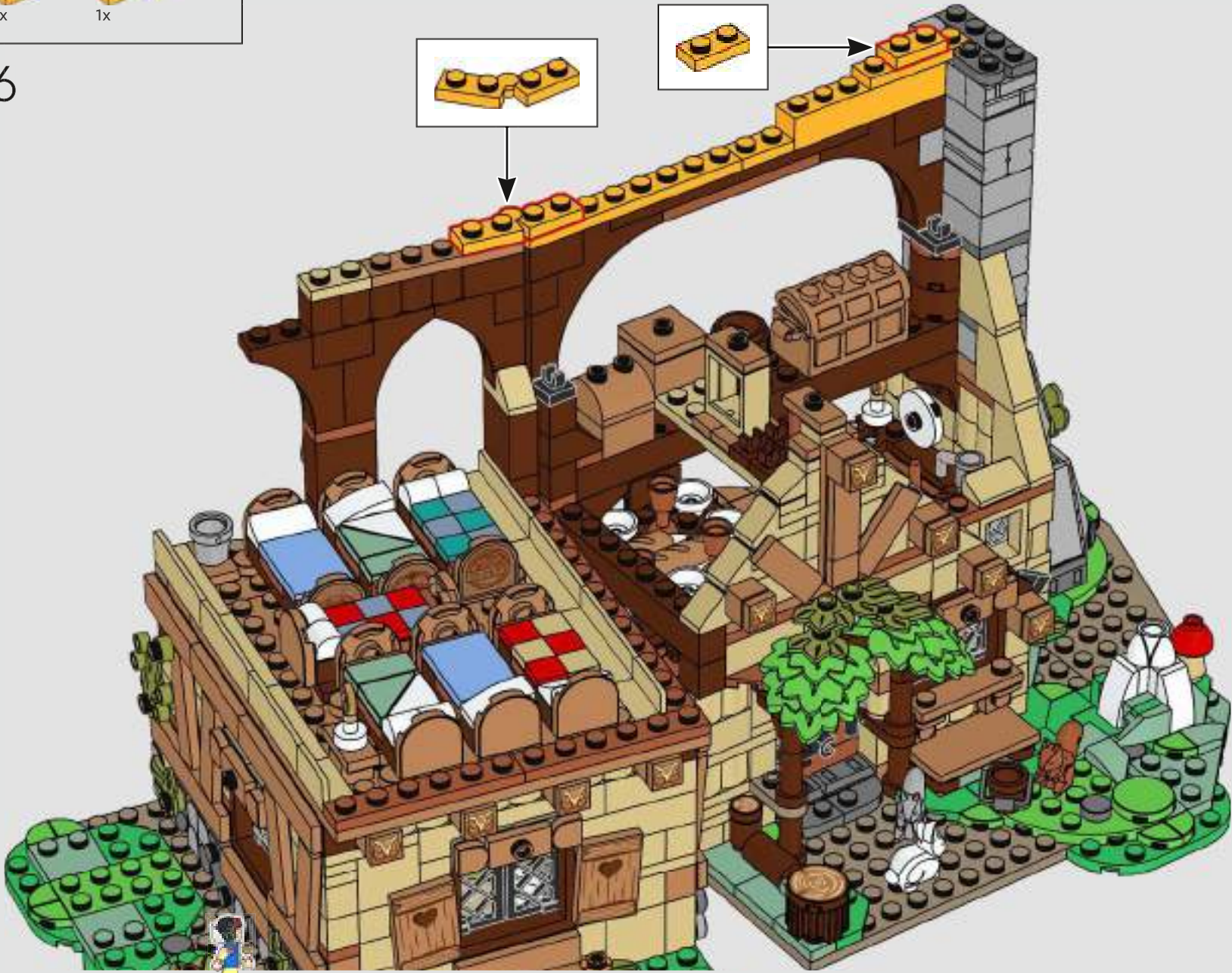
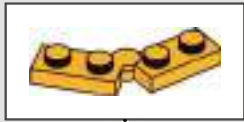





3x



3x

257







3x

258





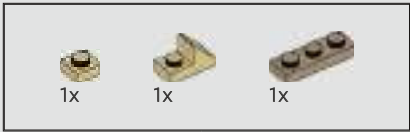

259

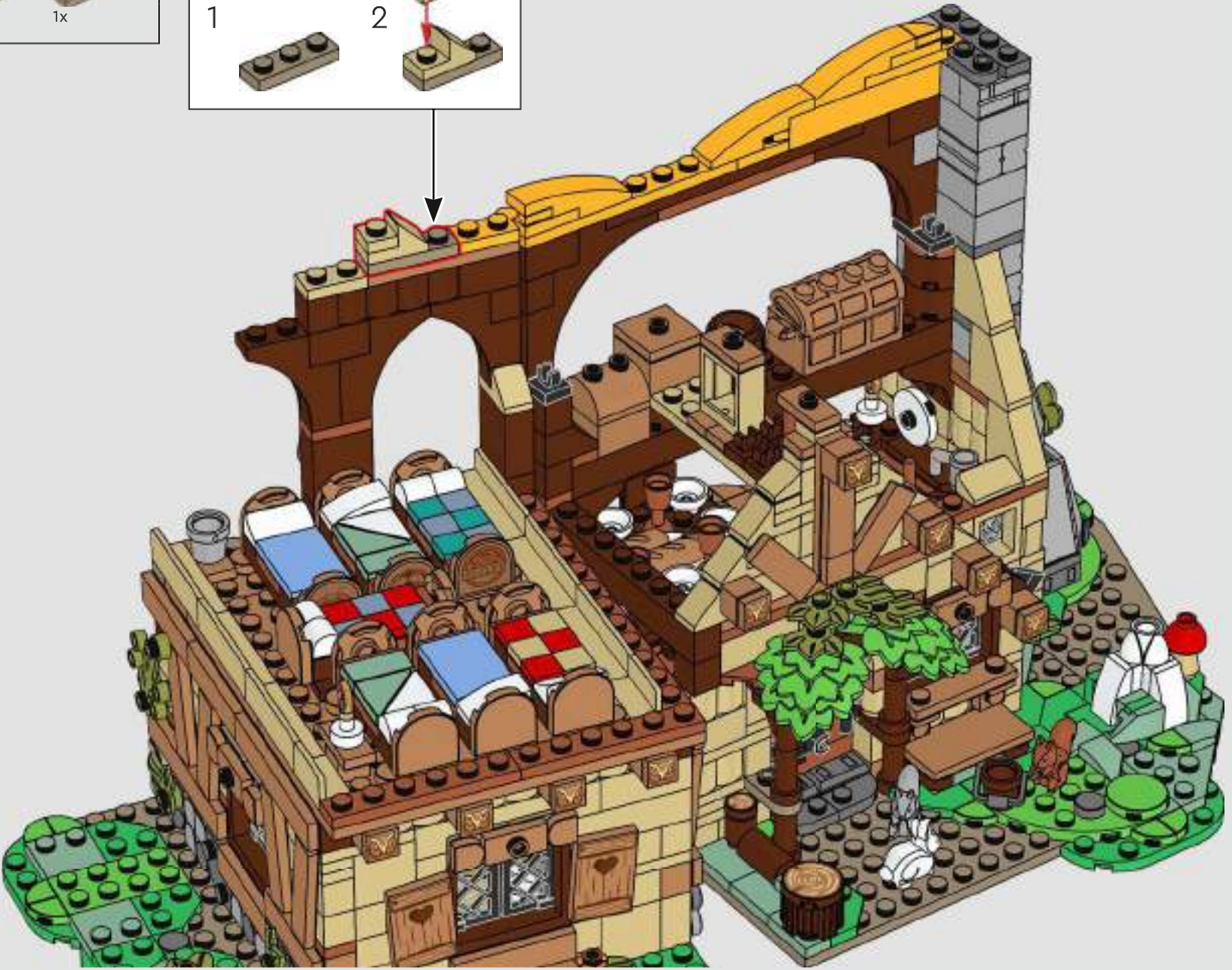
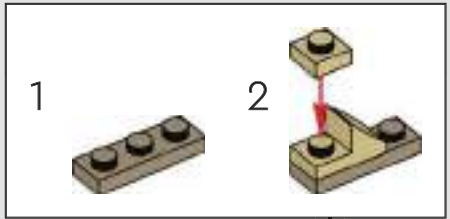



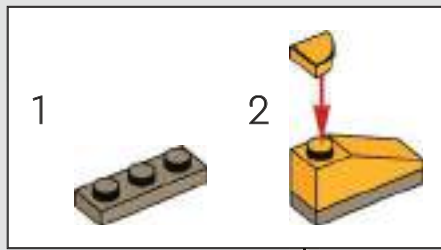

260

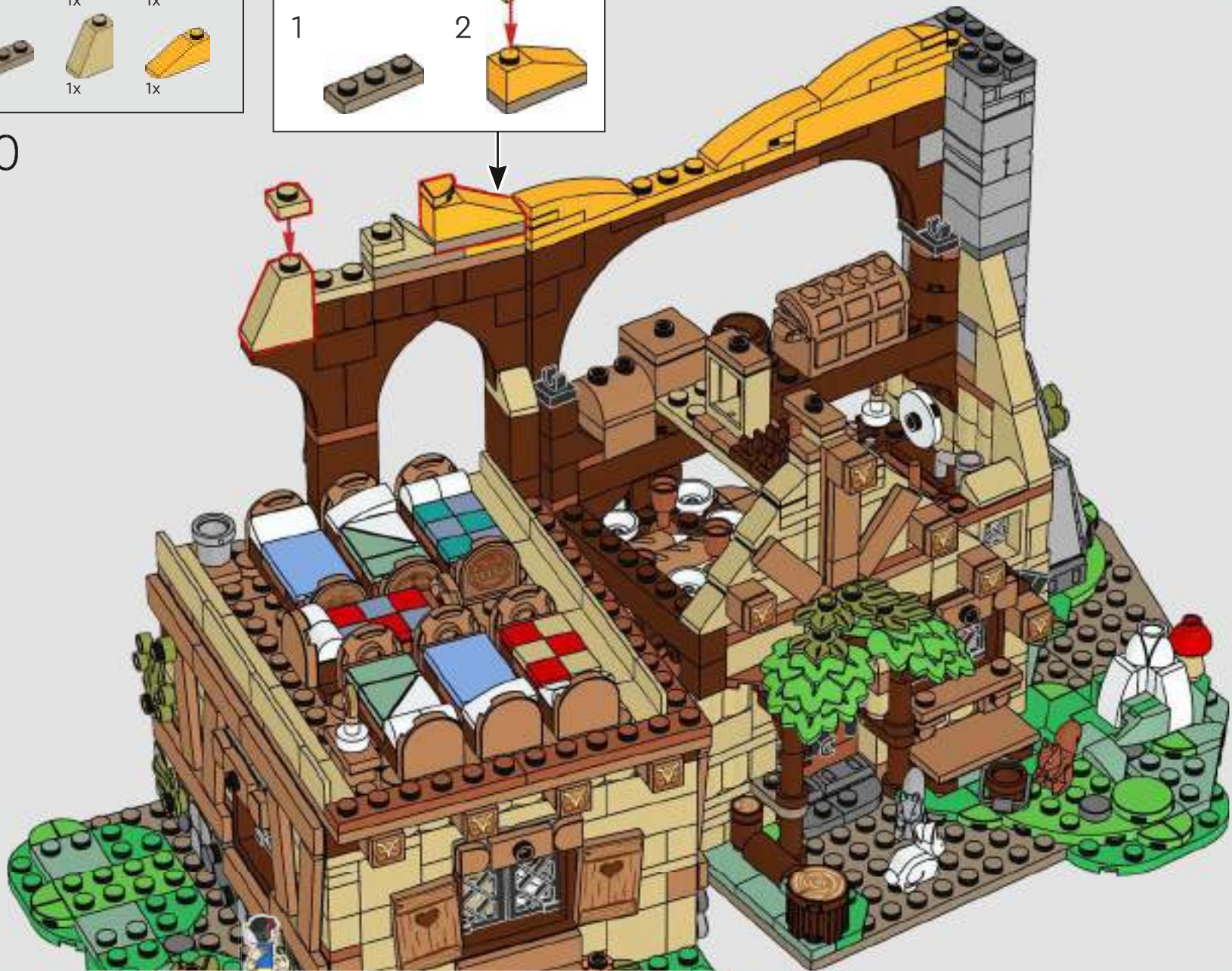



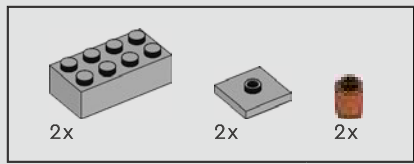

261

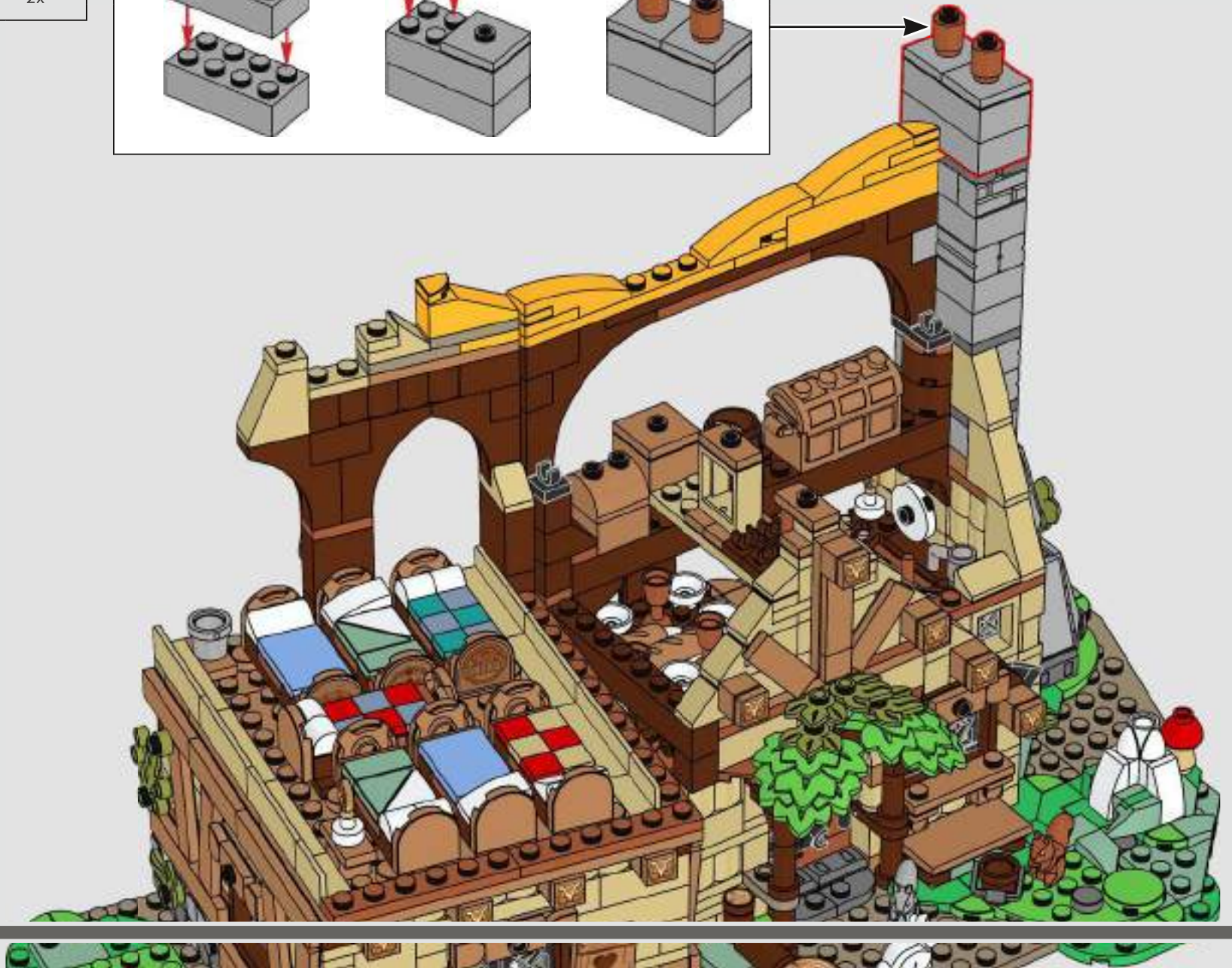
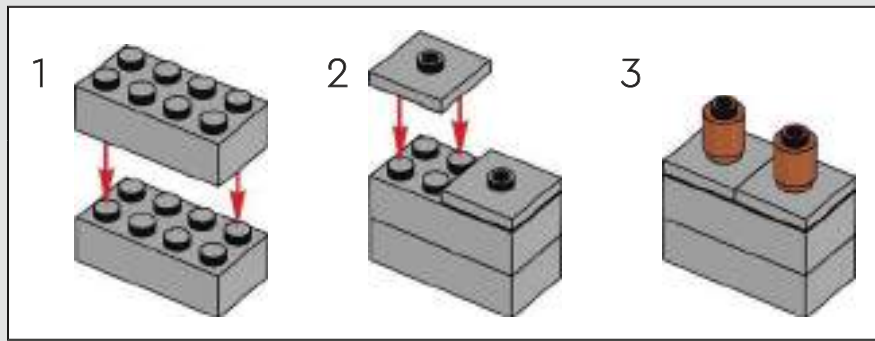





262

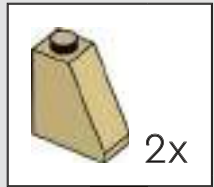



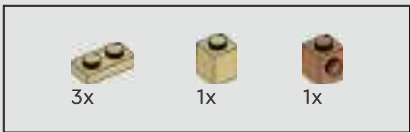

263

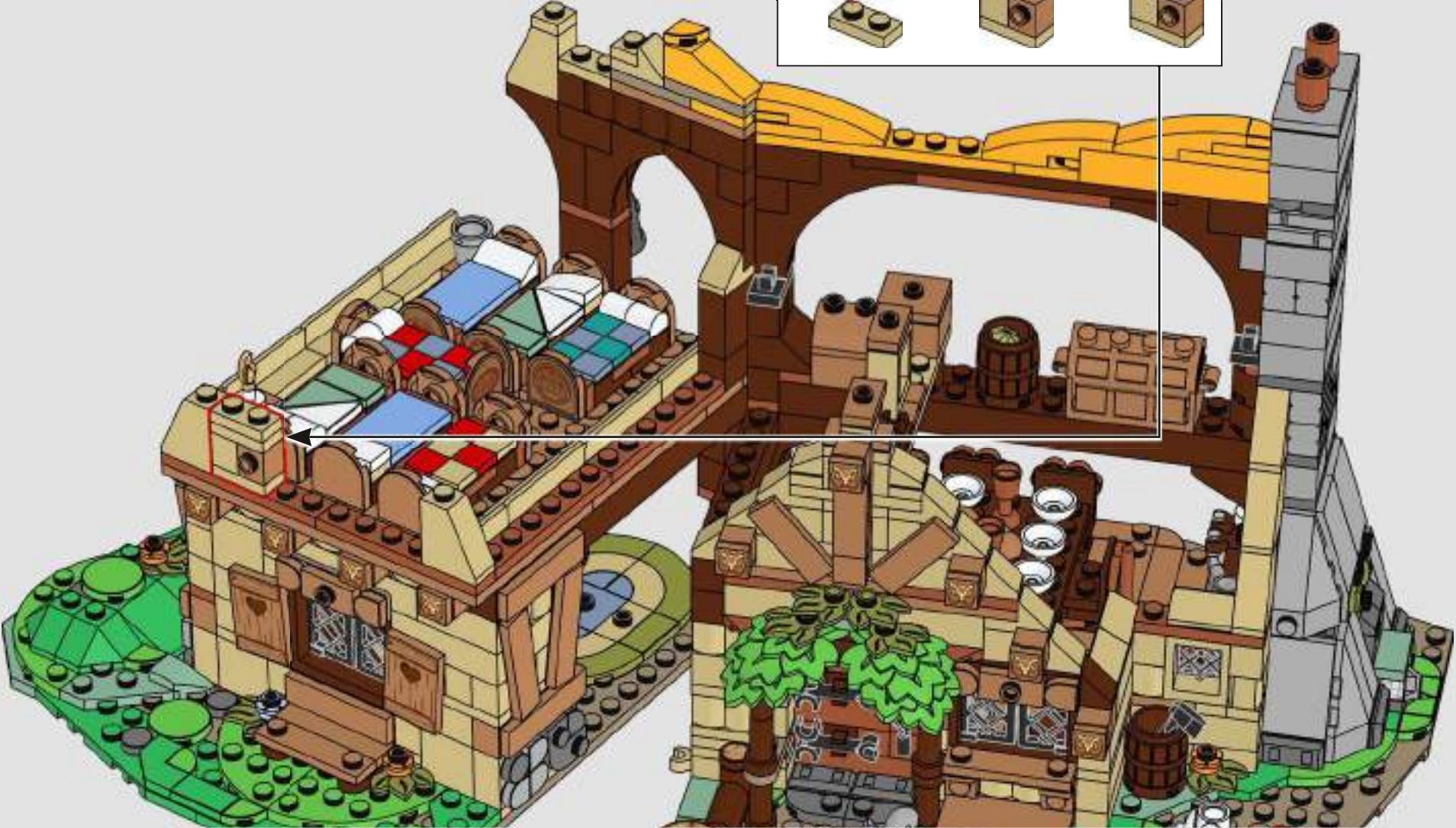
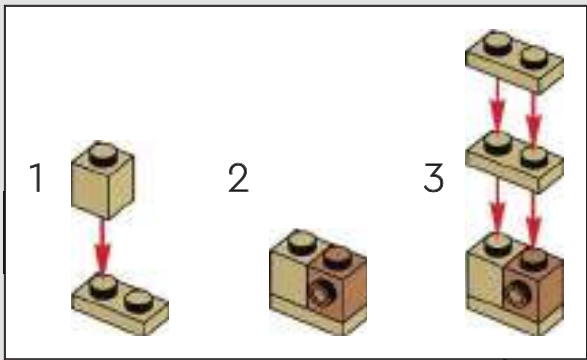



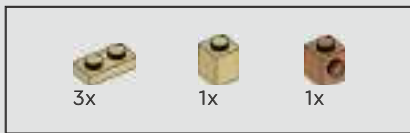

264

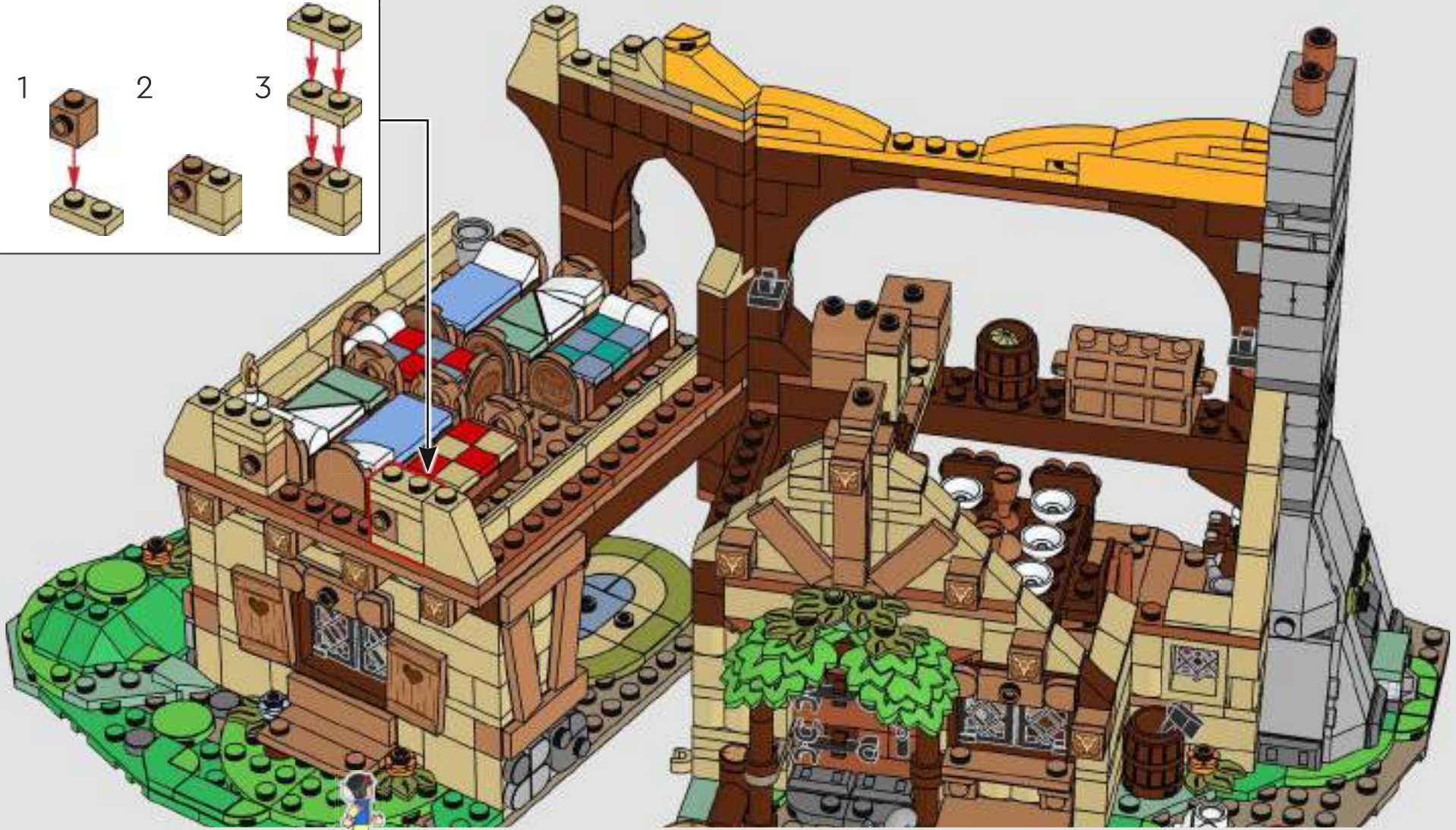
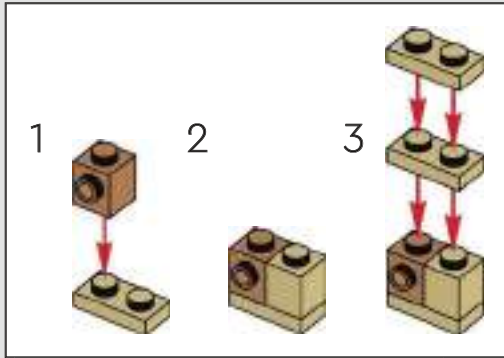





265

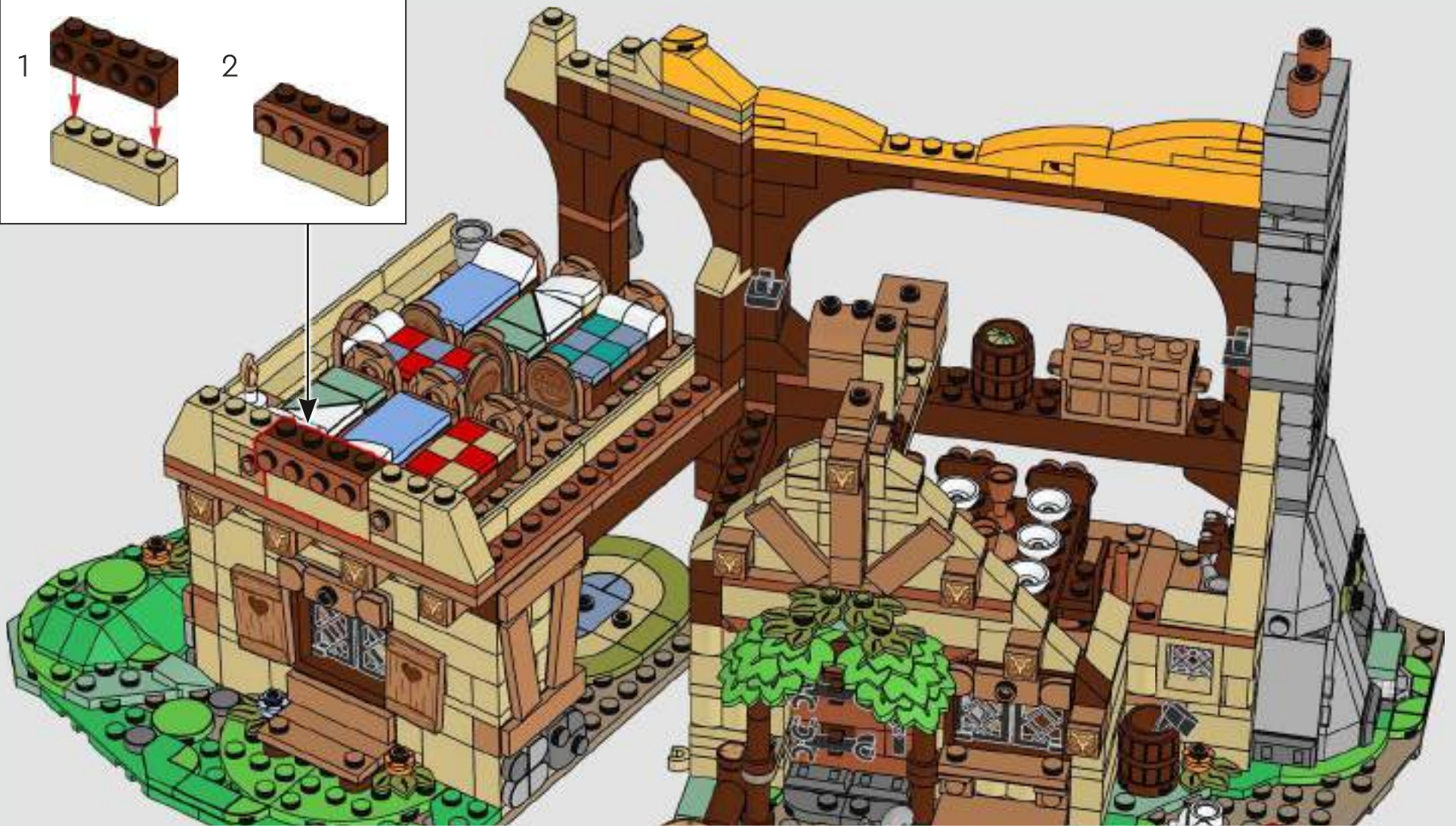
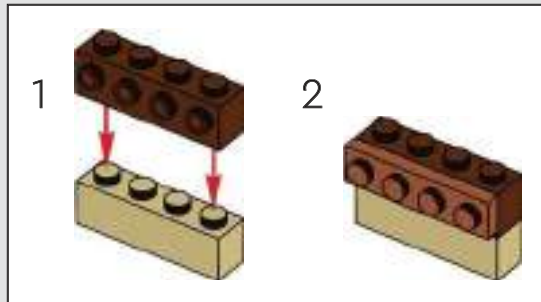





266

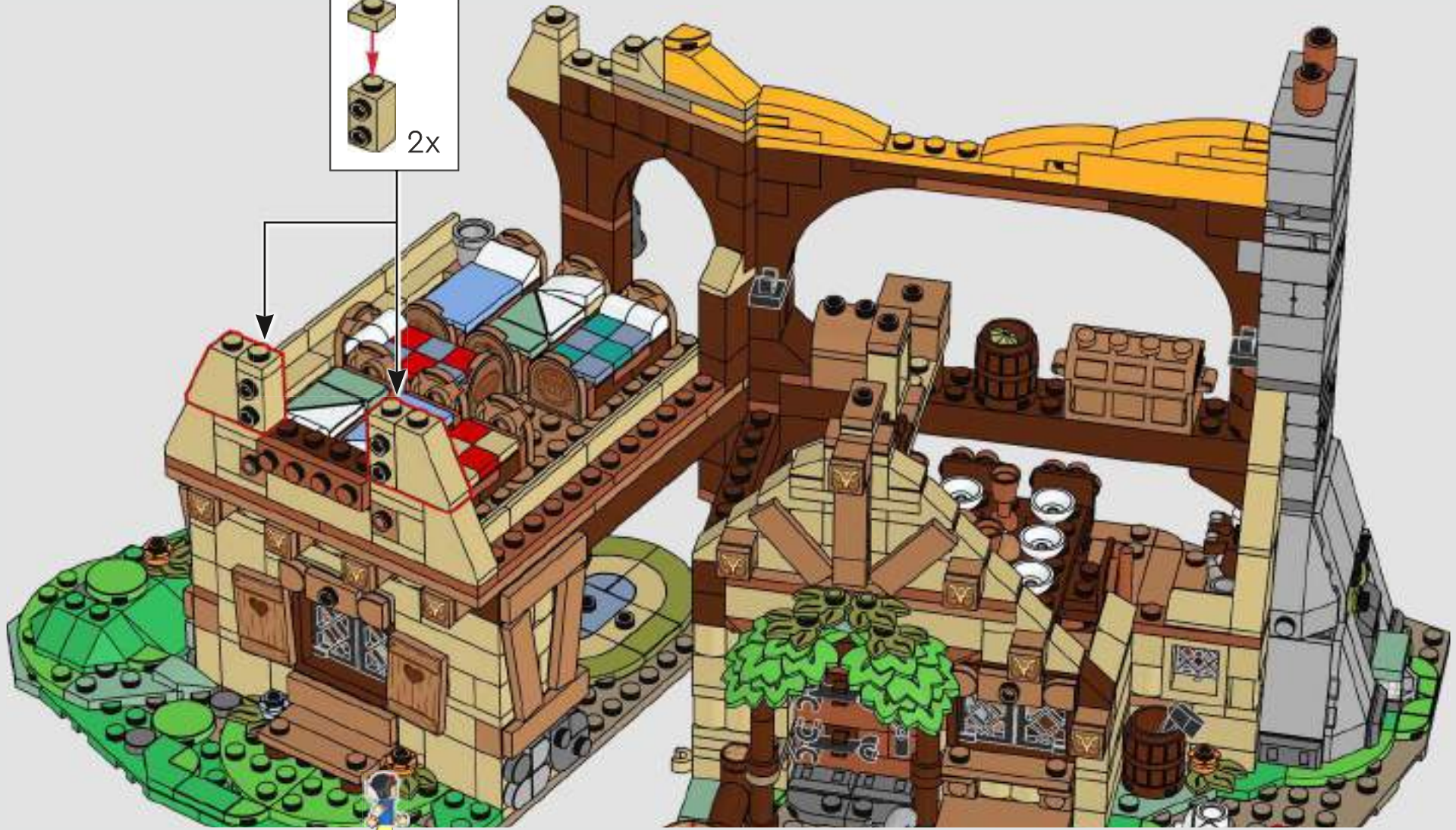
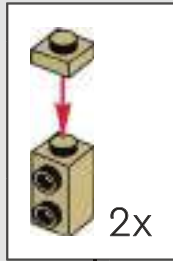





2x

267



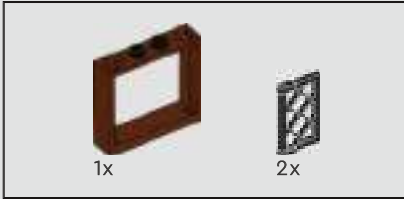

268

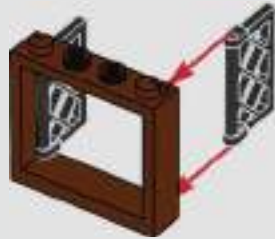

269



270

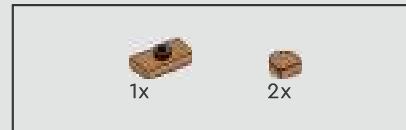

271





272



273

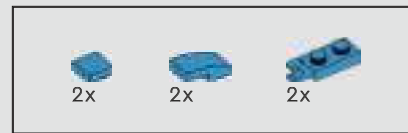

274

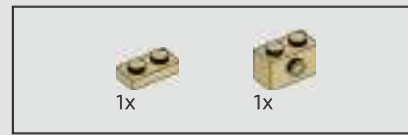
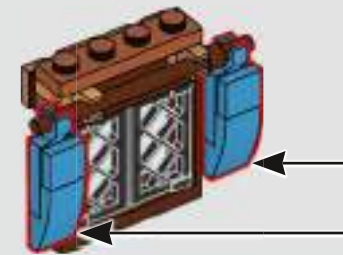
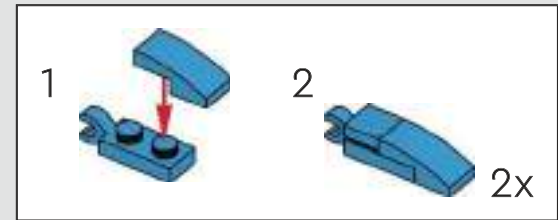

275

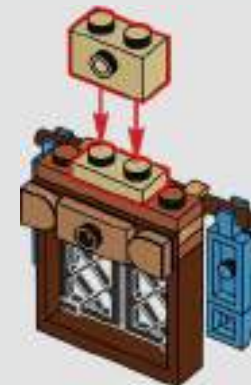









277

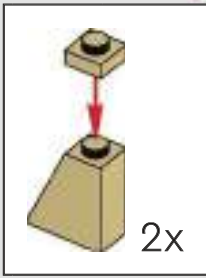
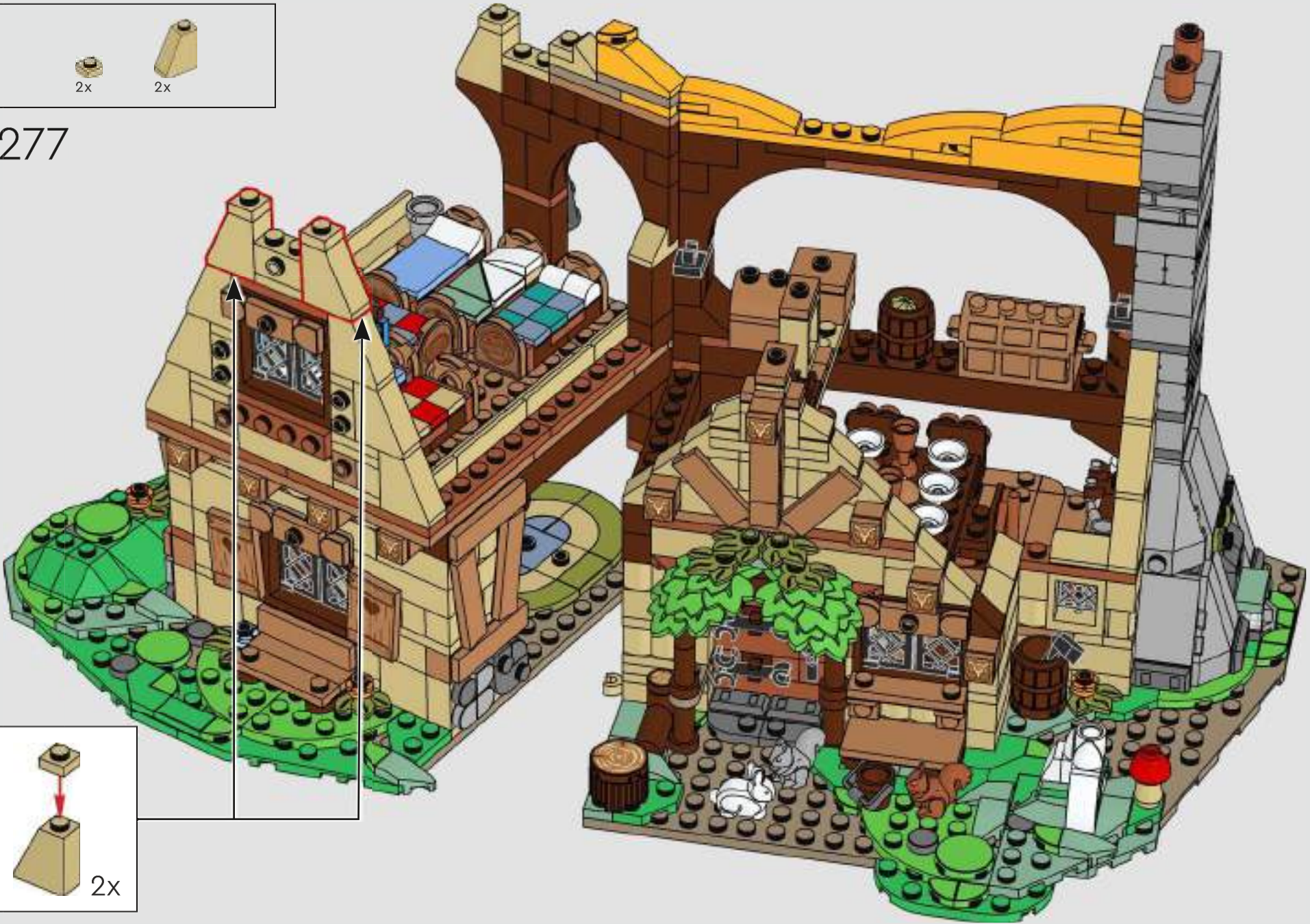

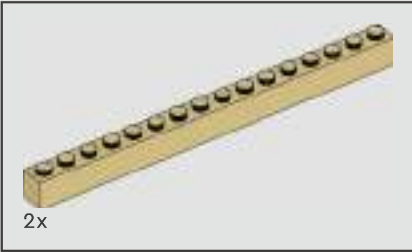

278

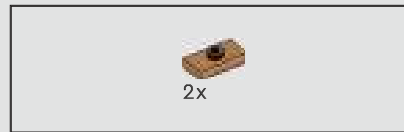
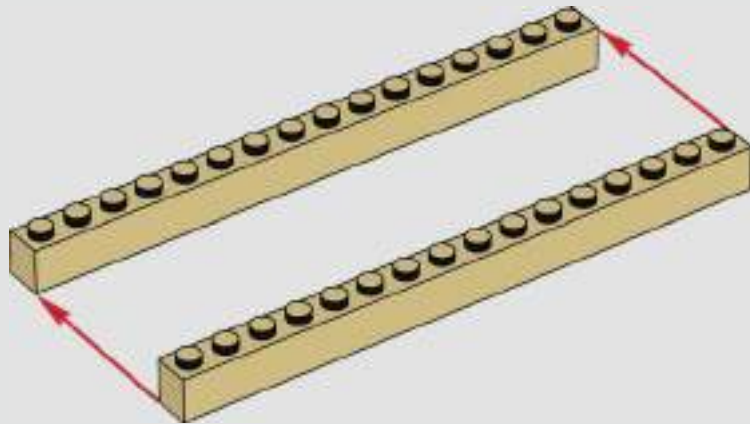

279

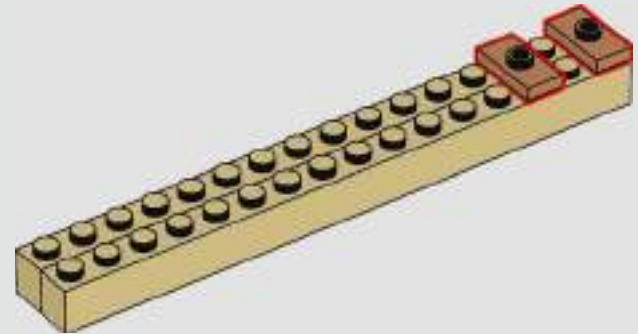

280

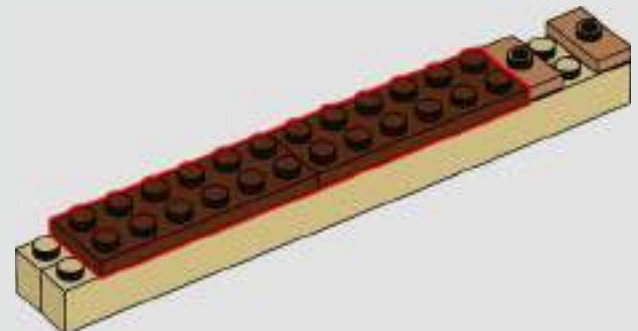





2x

281

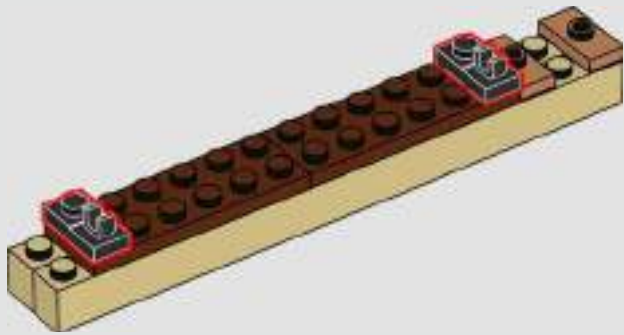

282

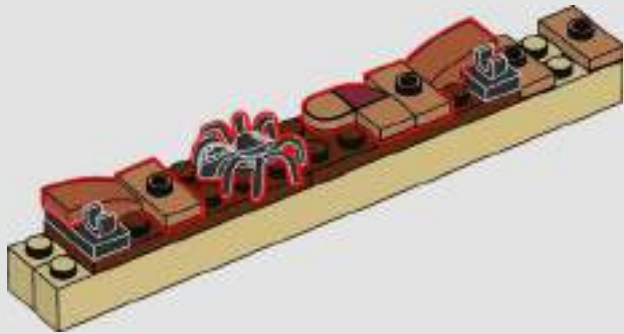

1x

1x

283

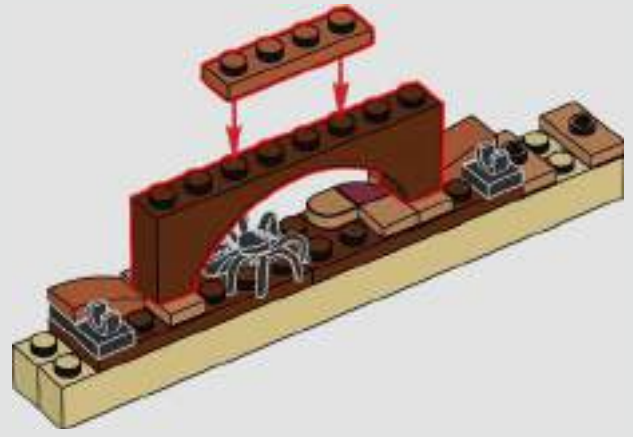







285







286







287







288

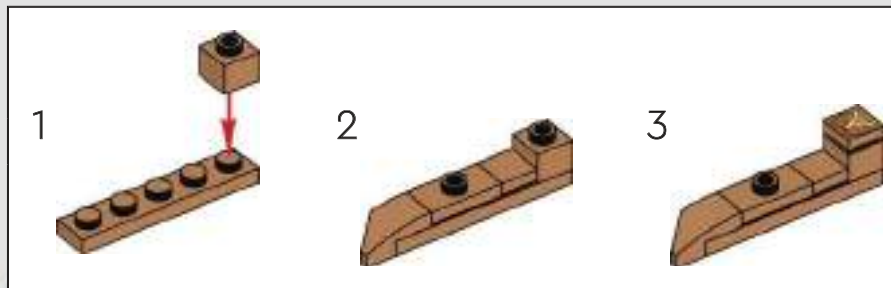





289

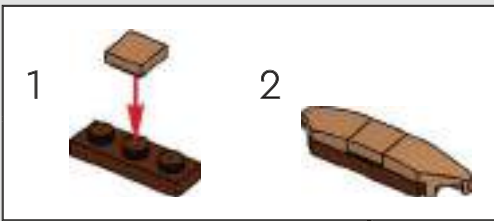



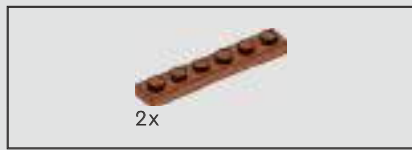

290







291





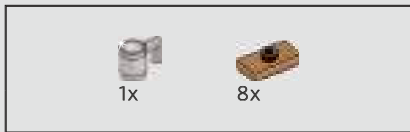

292







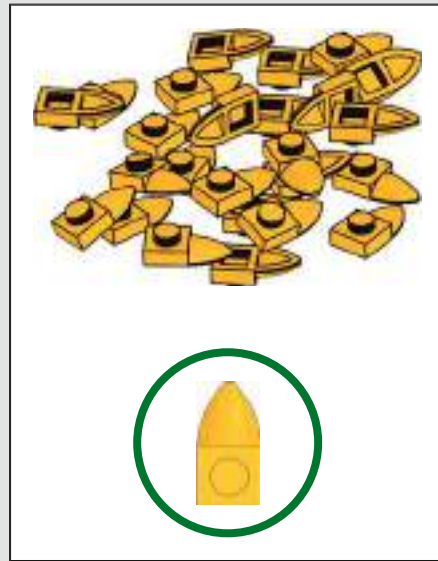
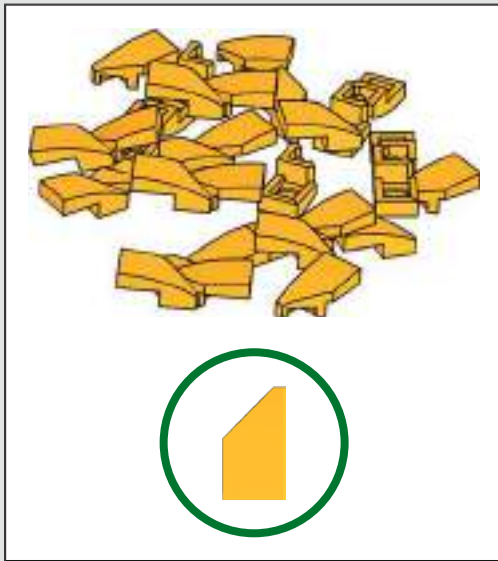



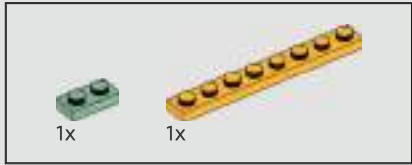

293

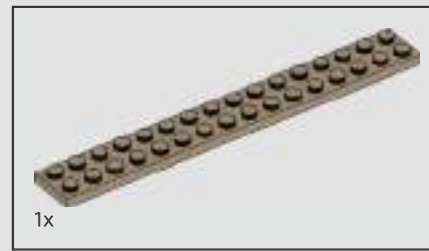

1x

294

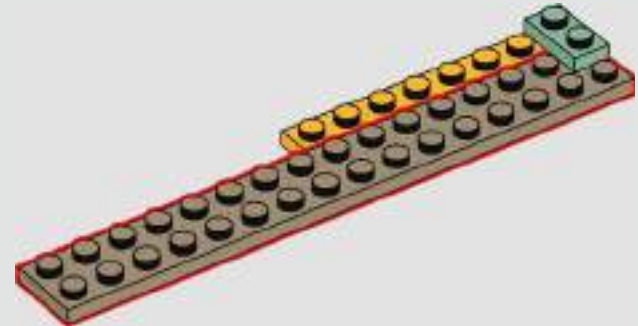

1x

295

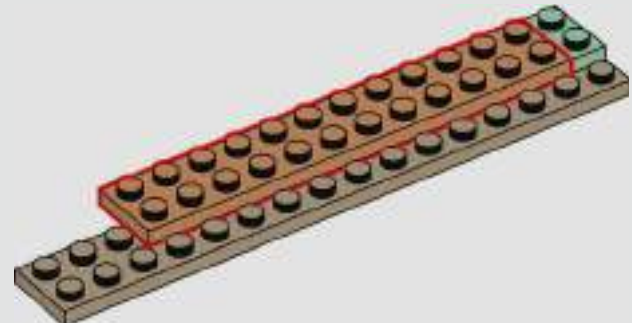

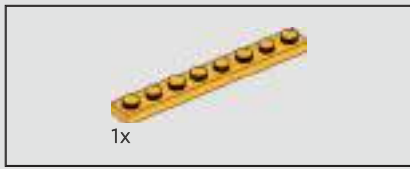

296

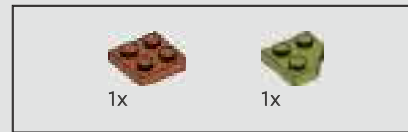
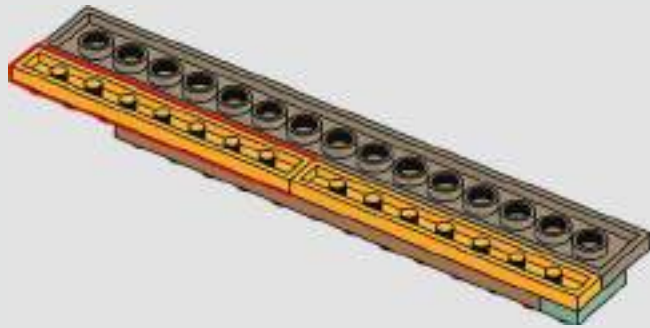

297

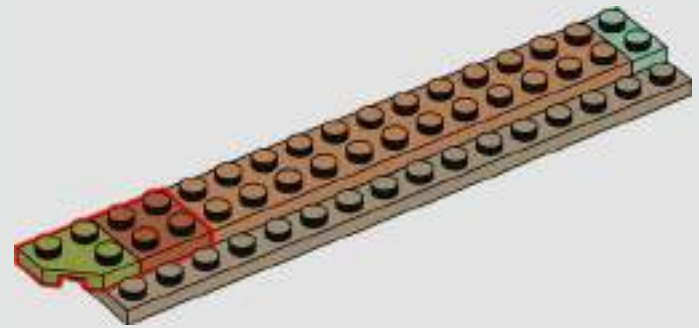
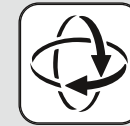

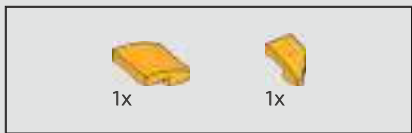

298

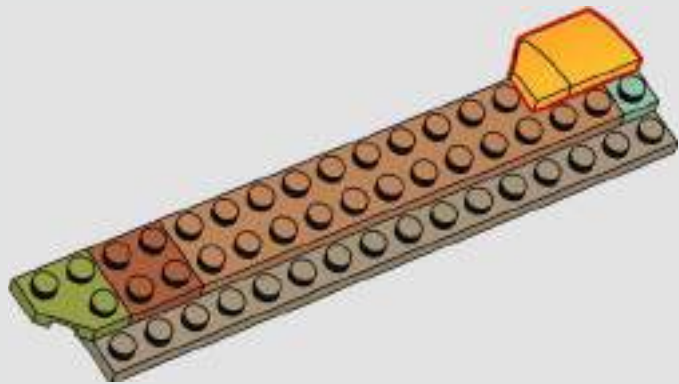

299

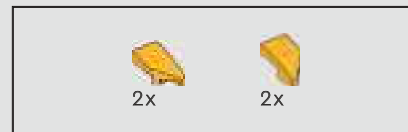
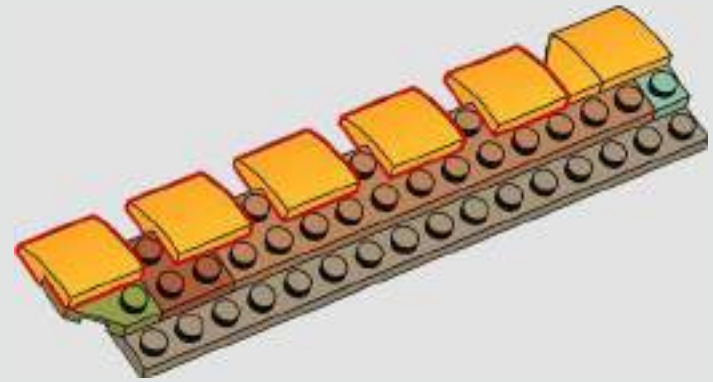

300

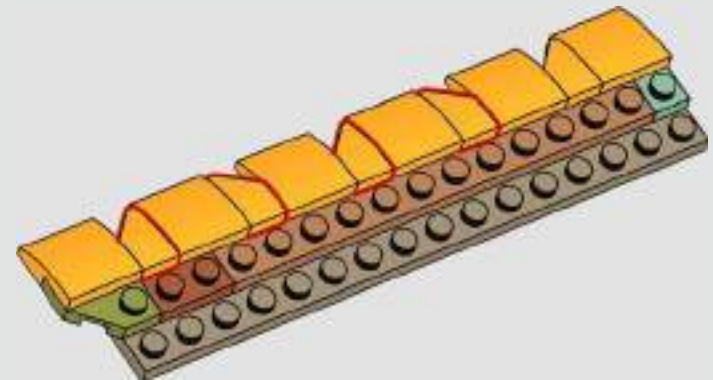



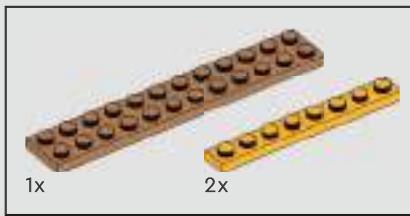

301

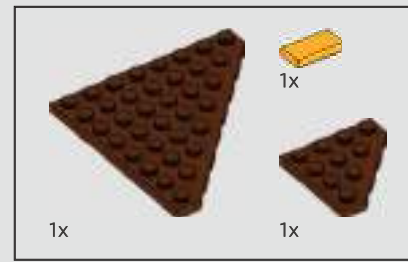
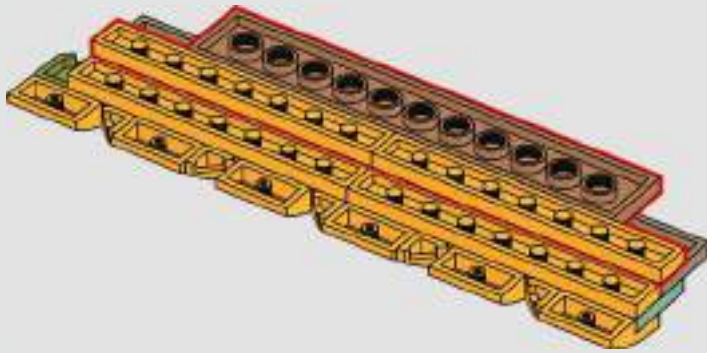

302

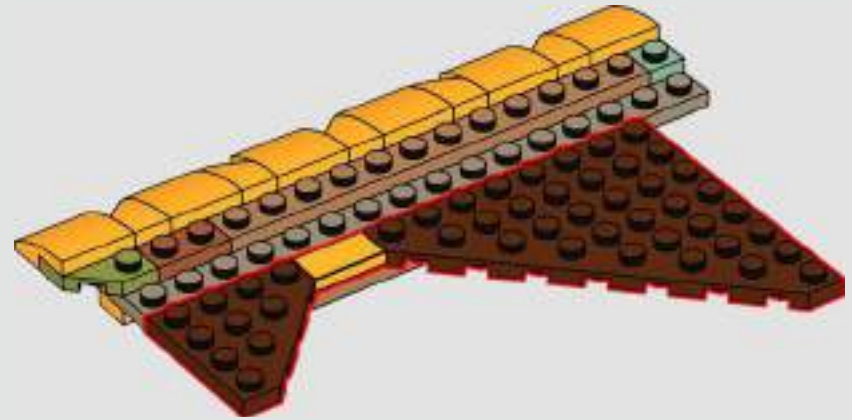



1x

# 303



# 304



# 305

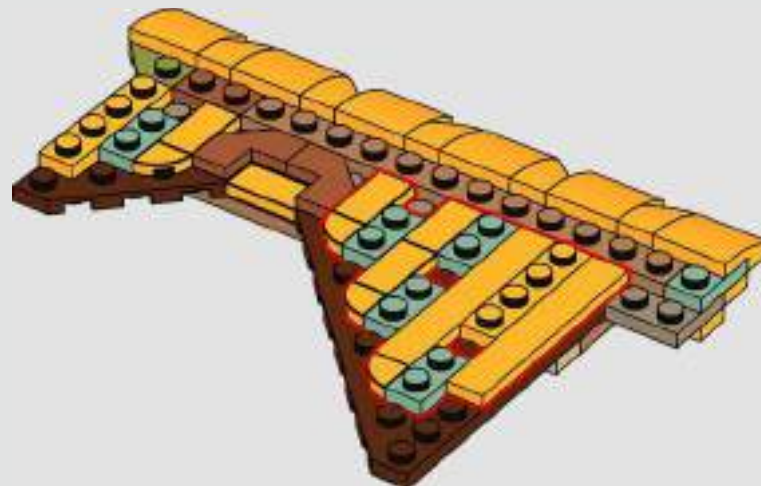

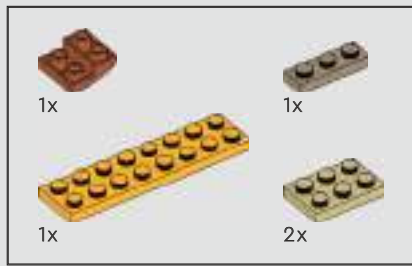

306

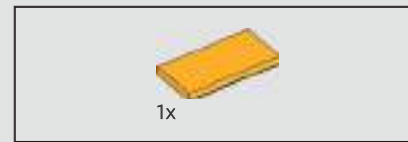
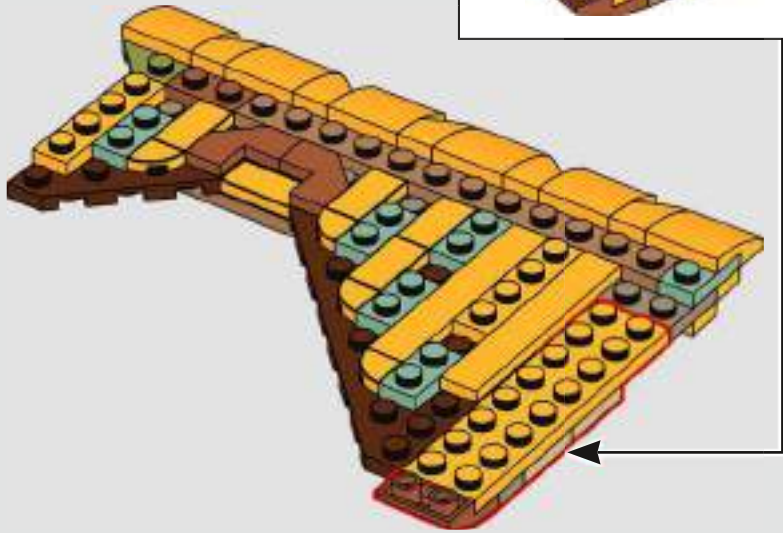
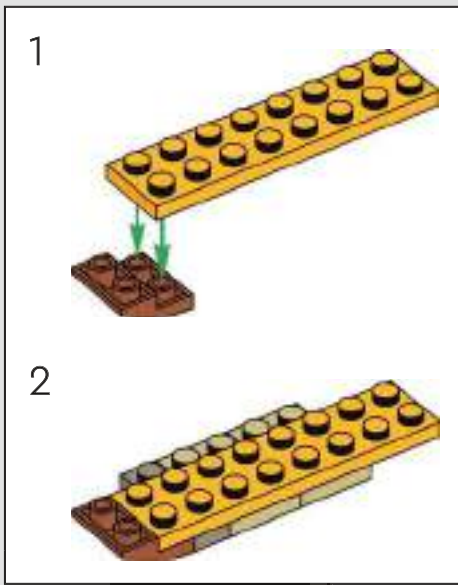

307

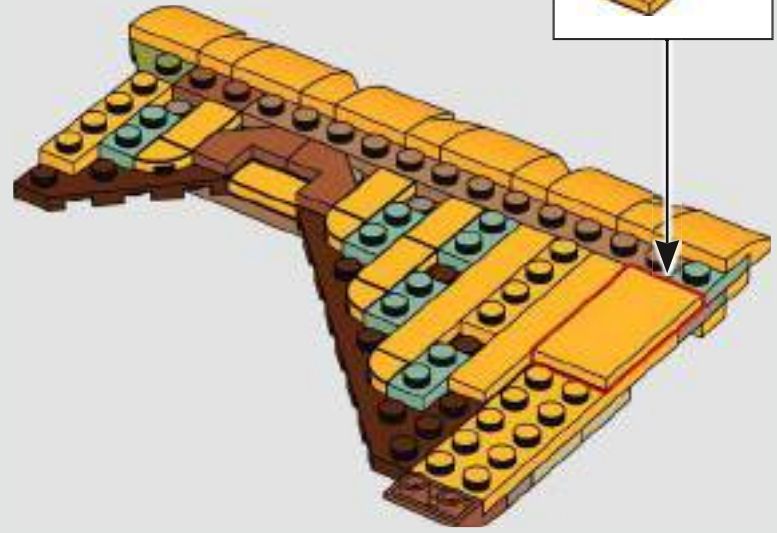
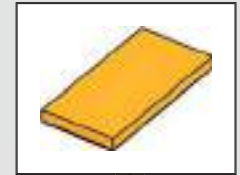





308

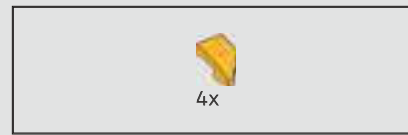
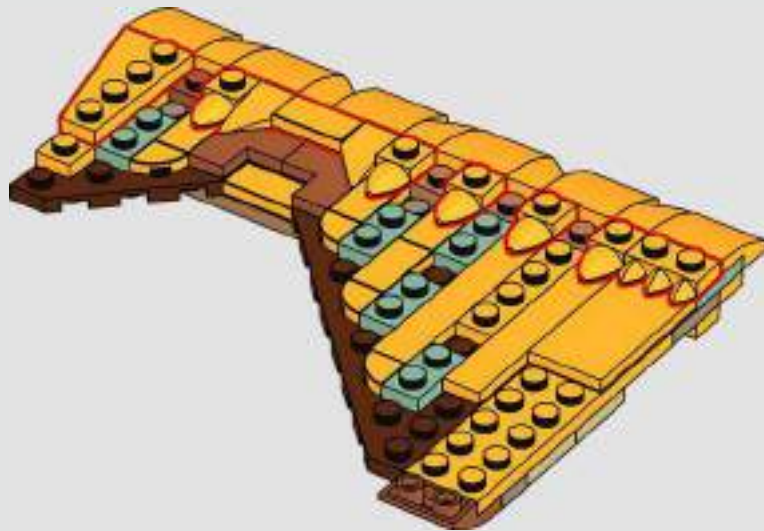

309

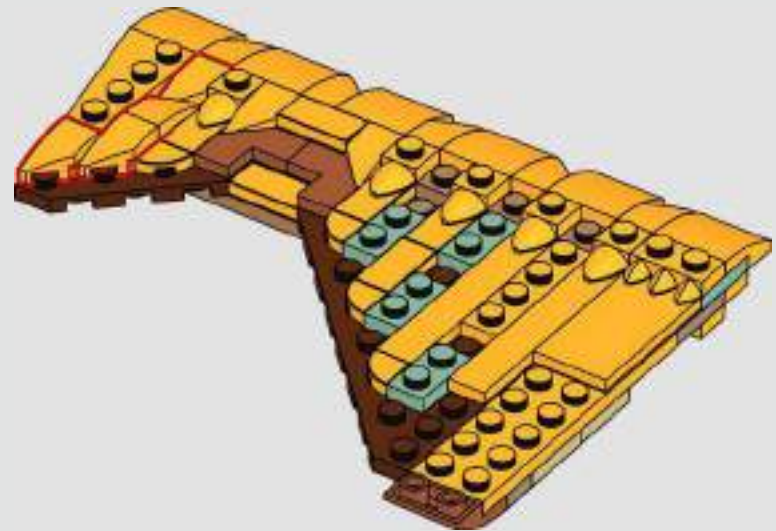



310

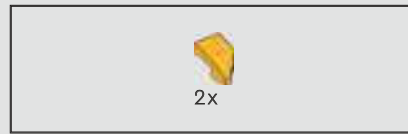
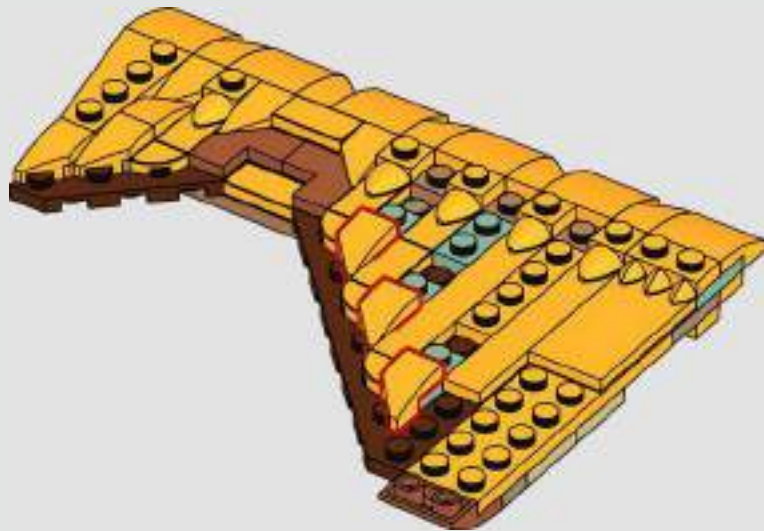

311

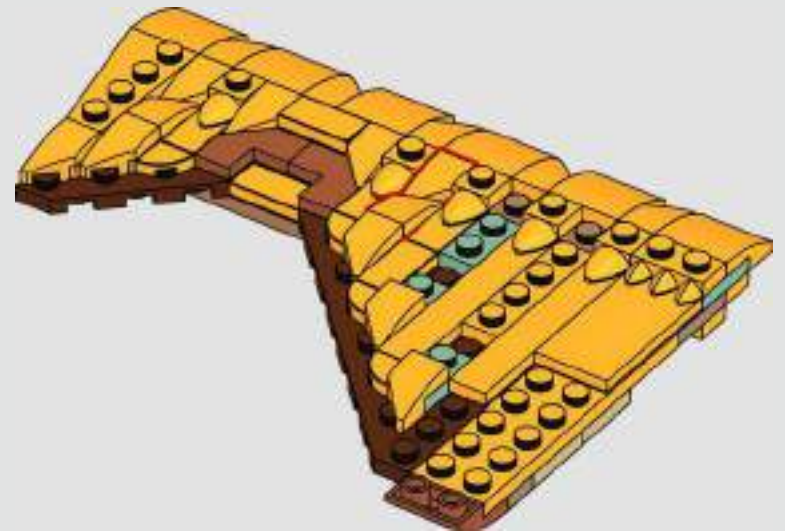



312

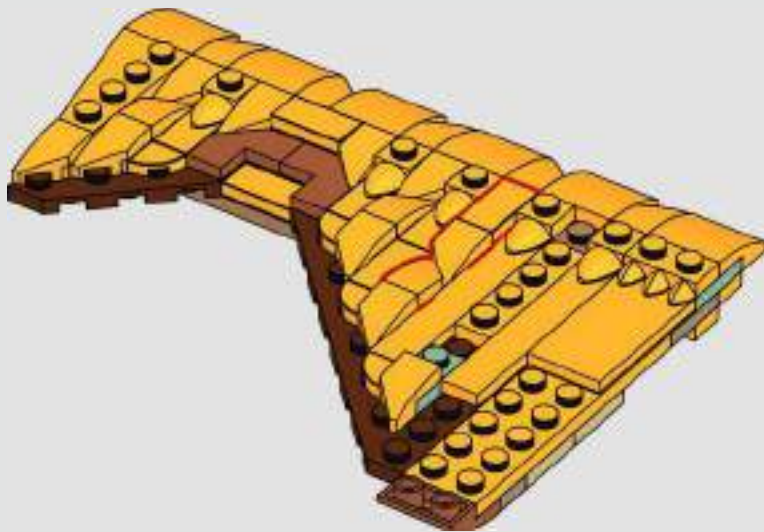

313

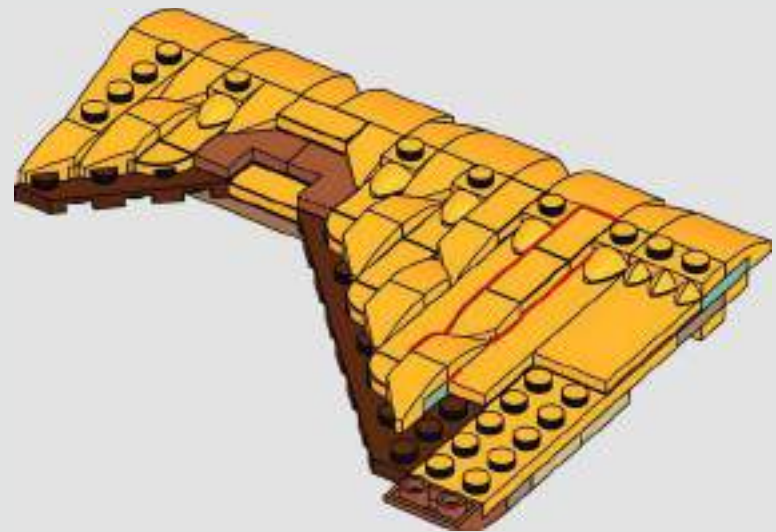



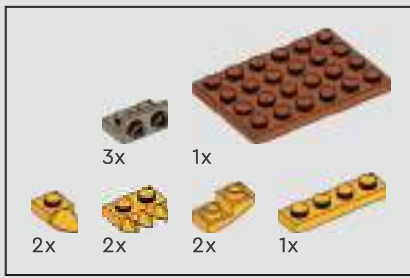

314

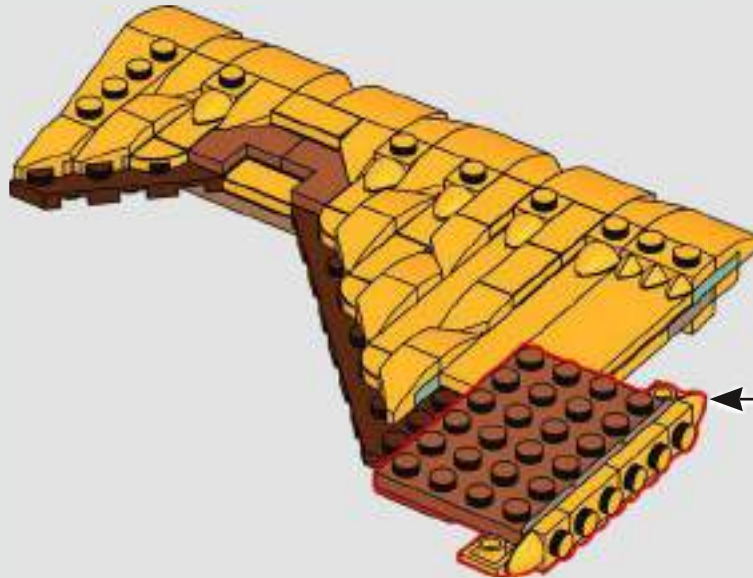
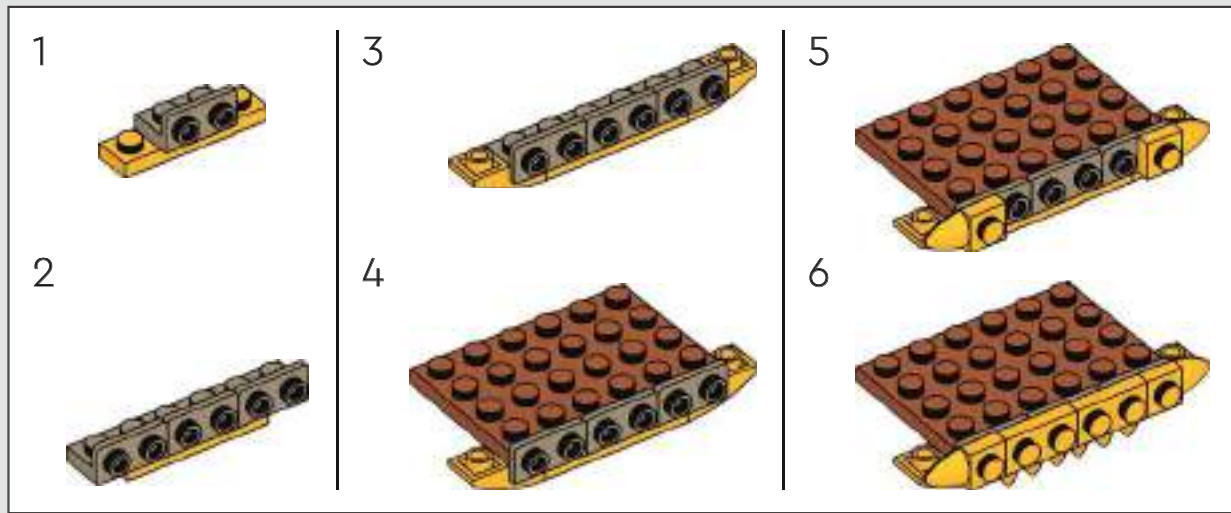

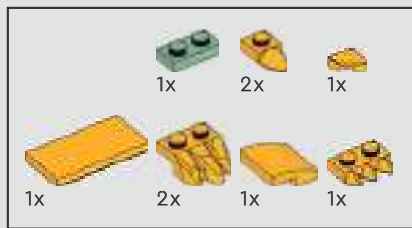

315

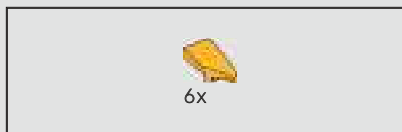
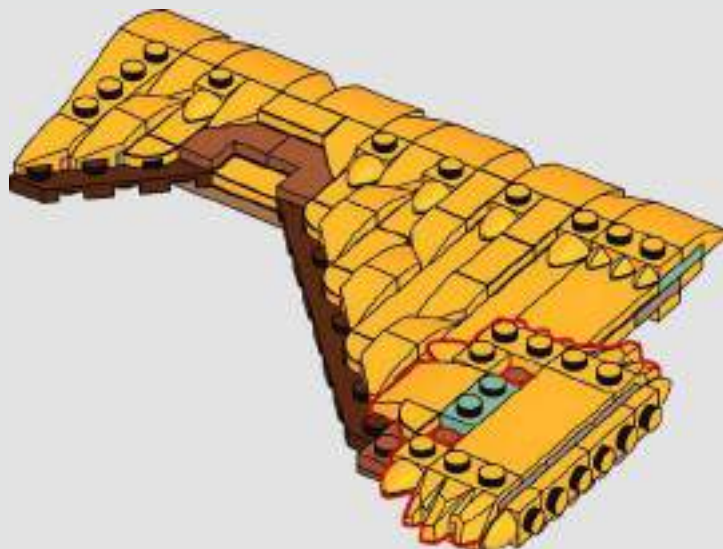

316

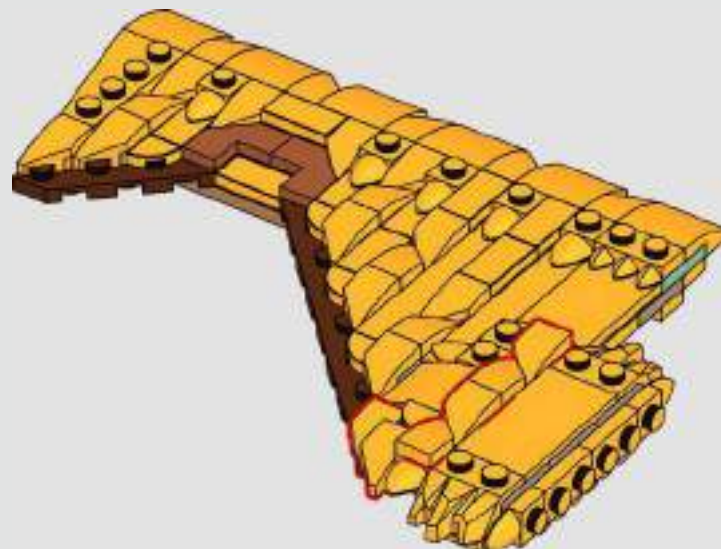

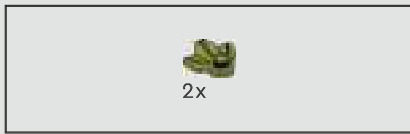

317

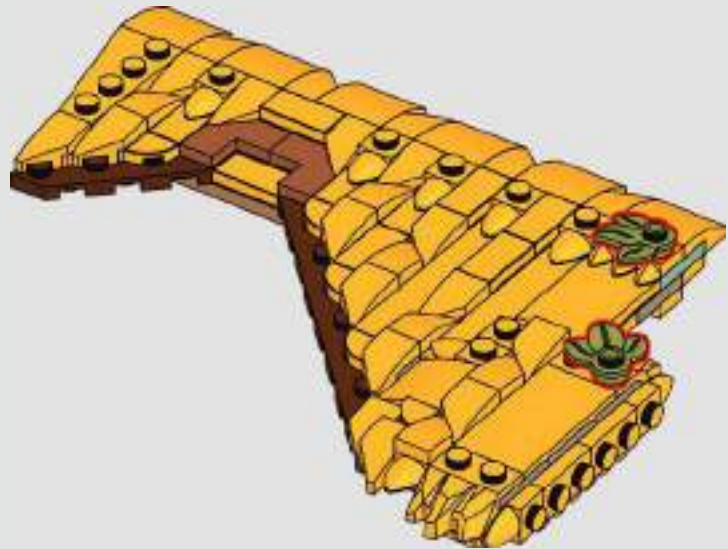

318

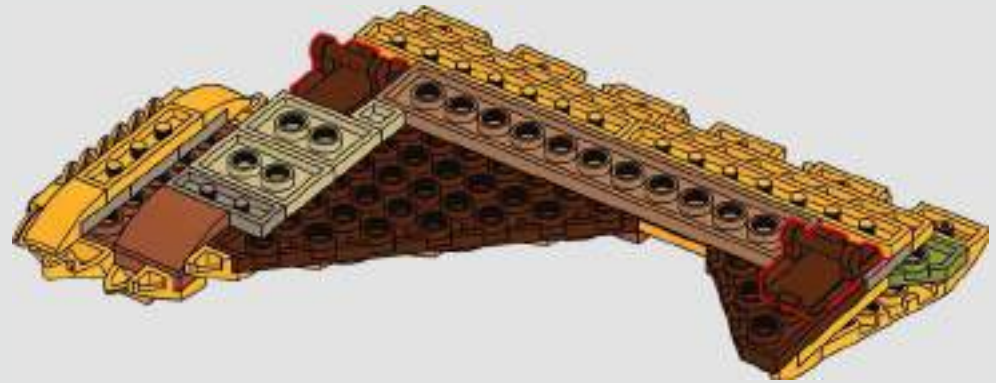







320

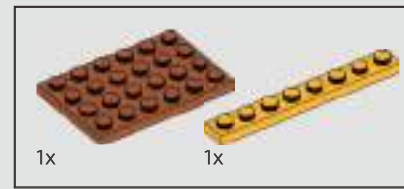

321



322







323

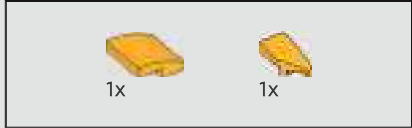
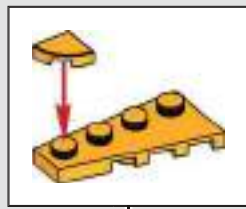

324

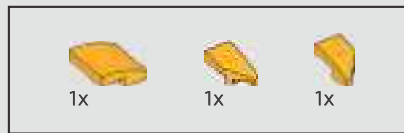

325

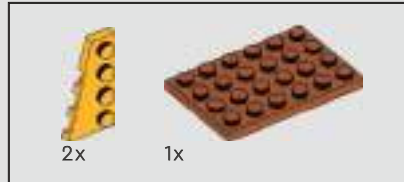
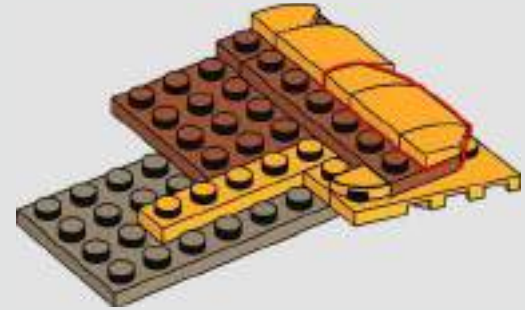

326





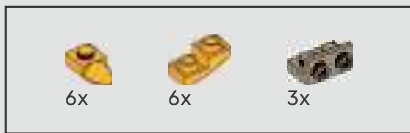

327

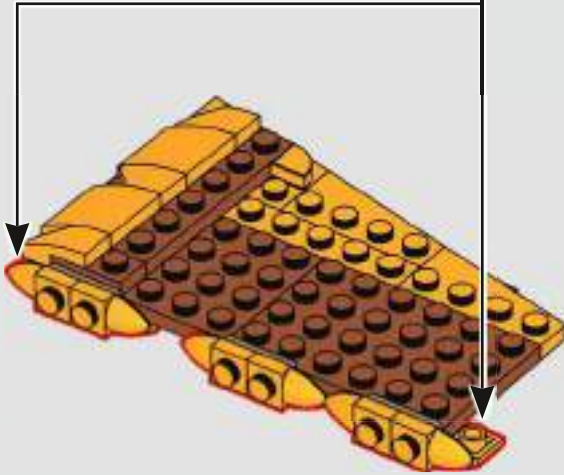

328

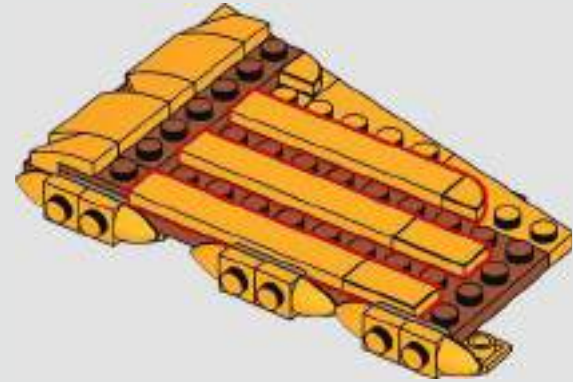

329

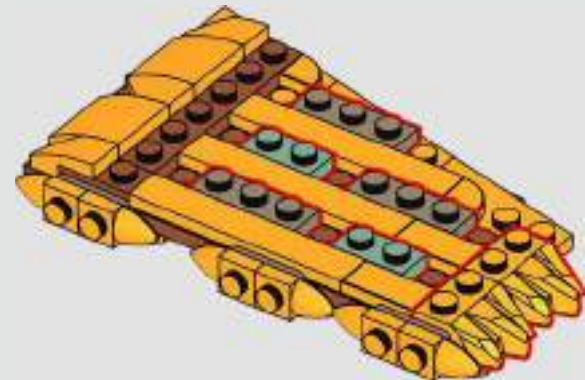



4x

330

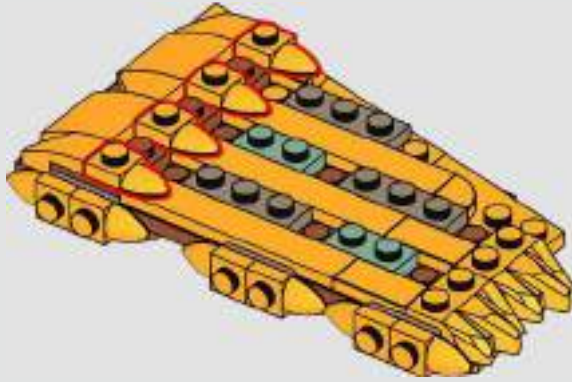

1x



3x

331

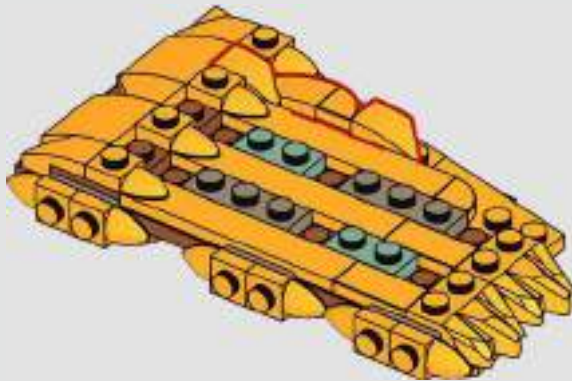

1x



6x

332

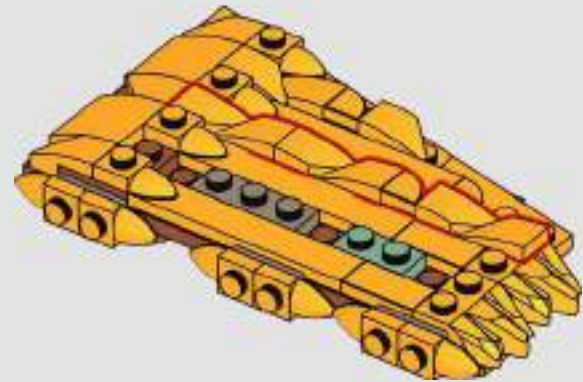



333

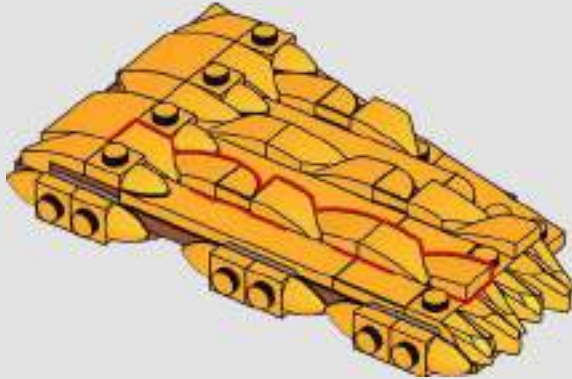

334

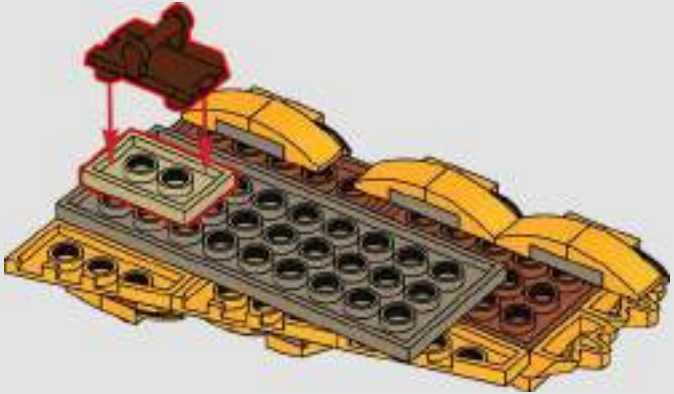





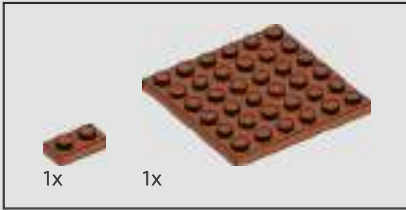

336

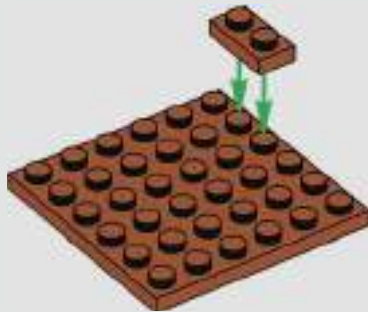

337



338



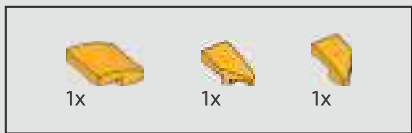

339



340



341

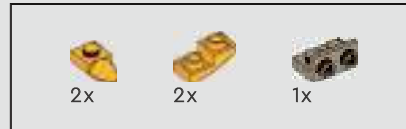
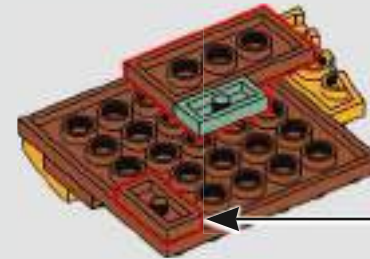

342

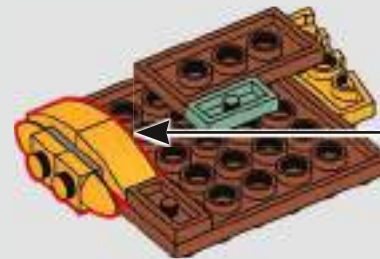
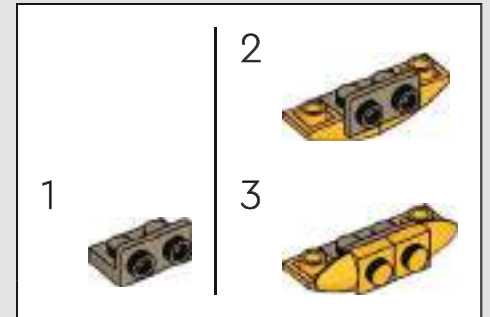





343

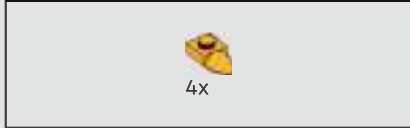

344

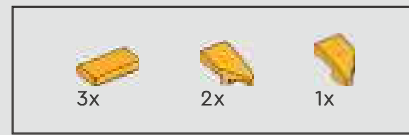

345

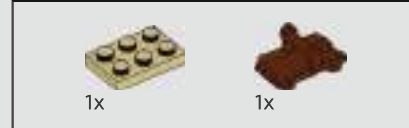

346

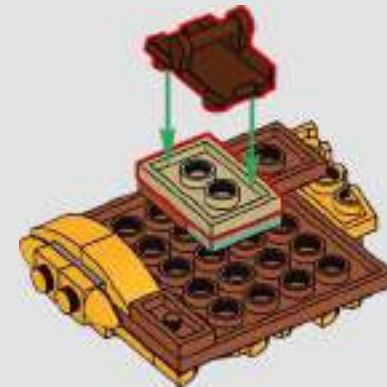



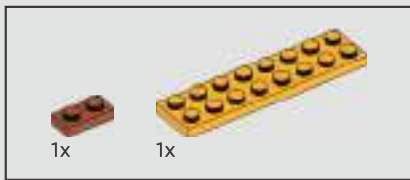

348

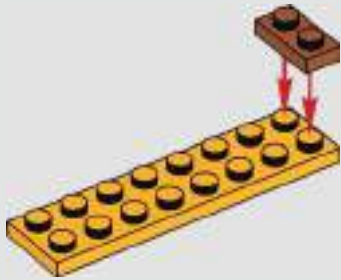

349

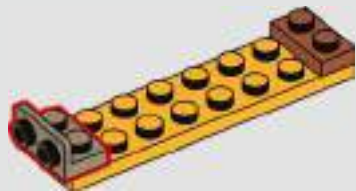

350

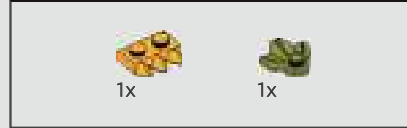
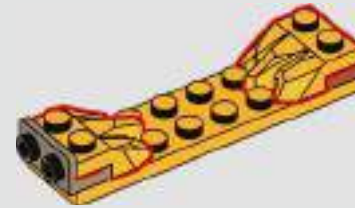

351







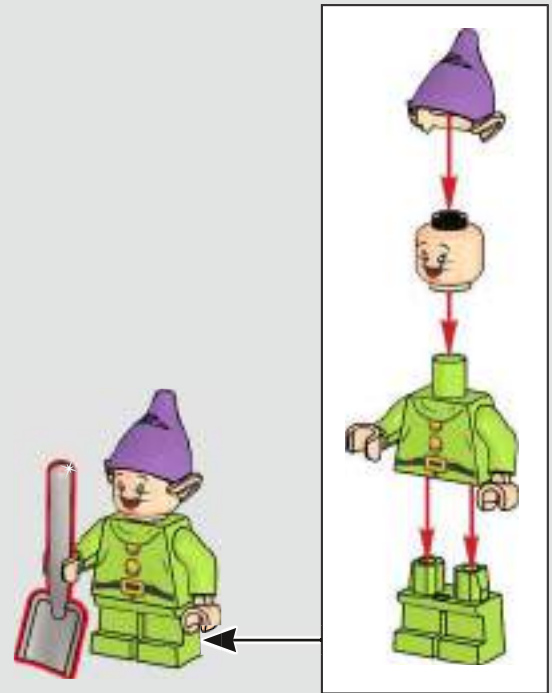





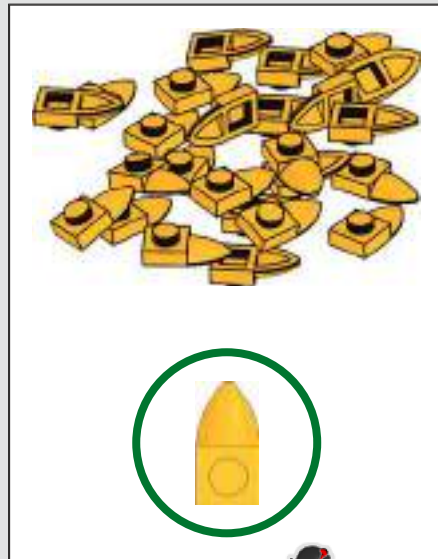
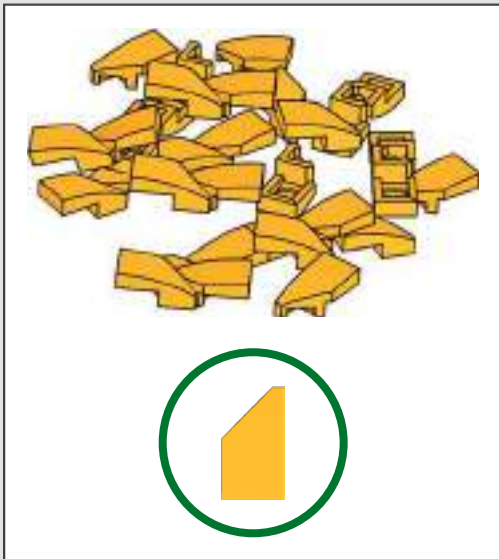



353

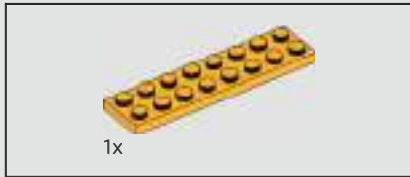
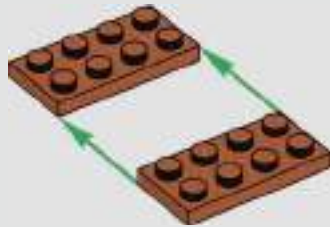

354



355



356

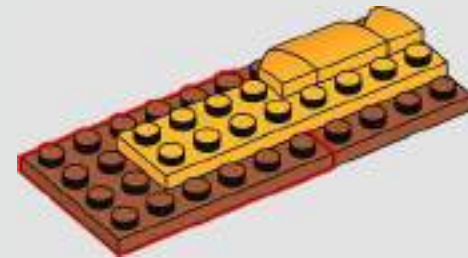

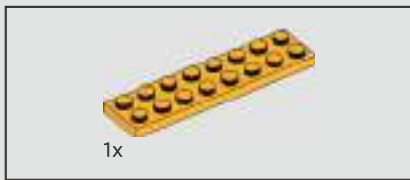

357

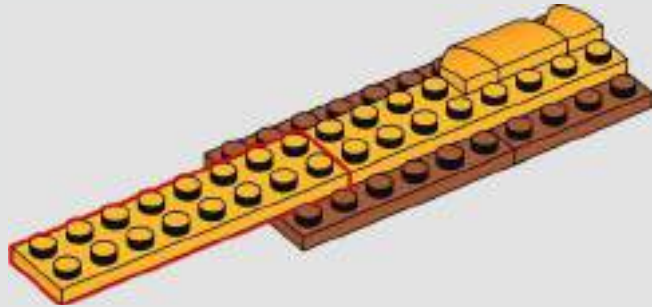

358

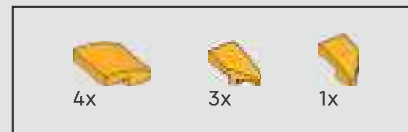
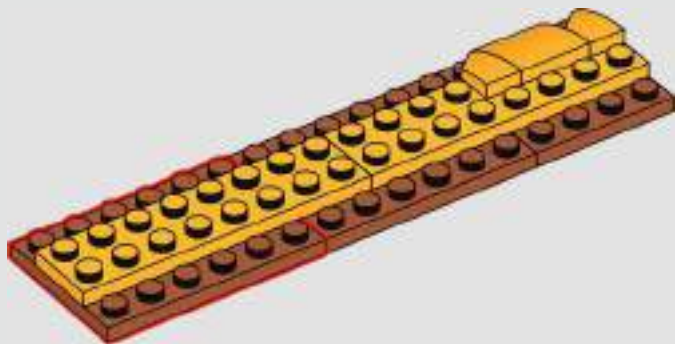

359

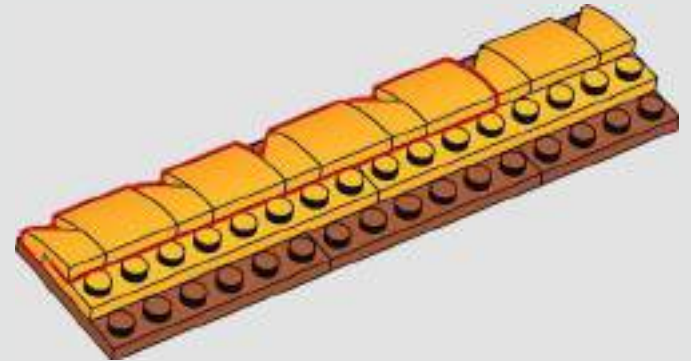

360

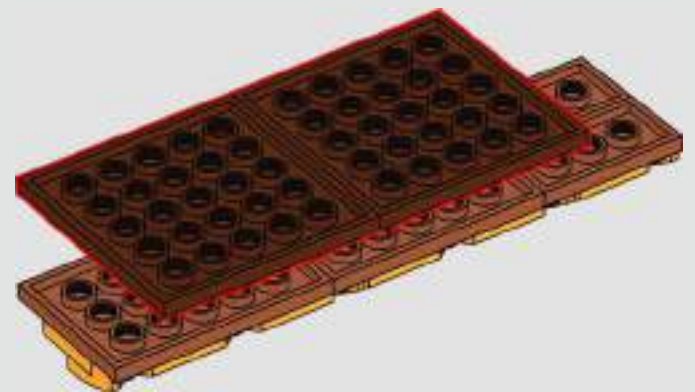





361

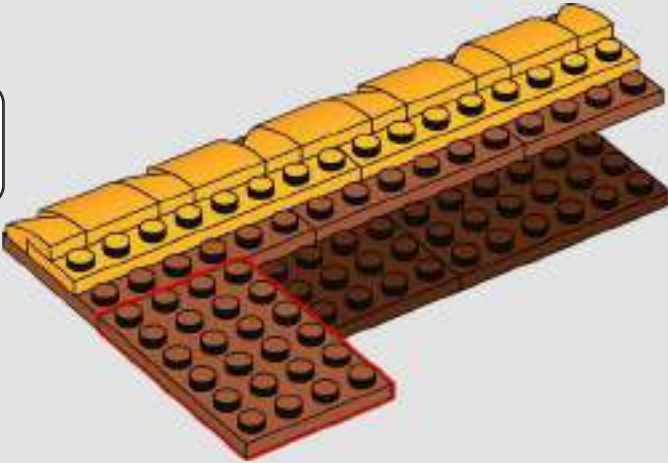

362

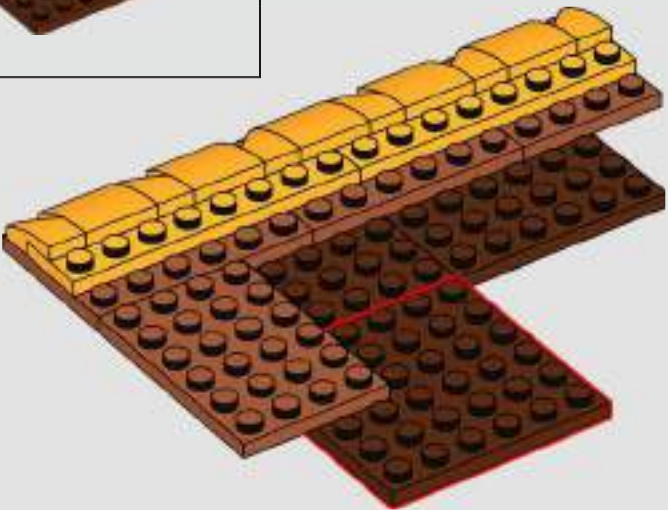

363

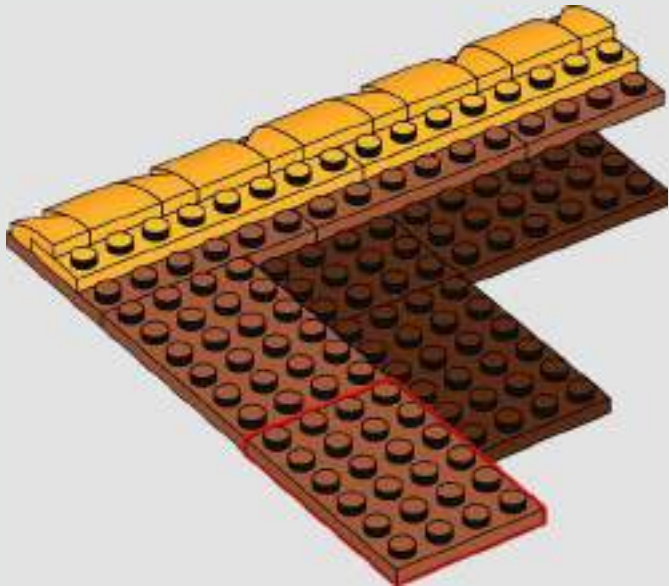

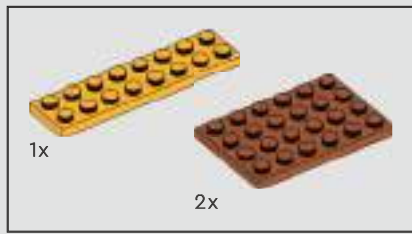

364

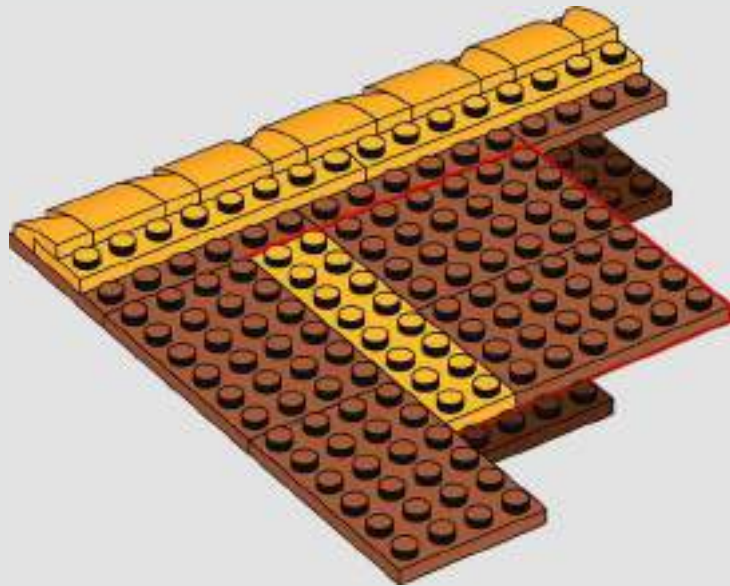

365

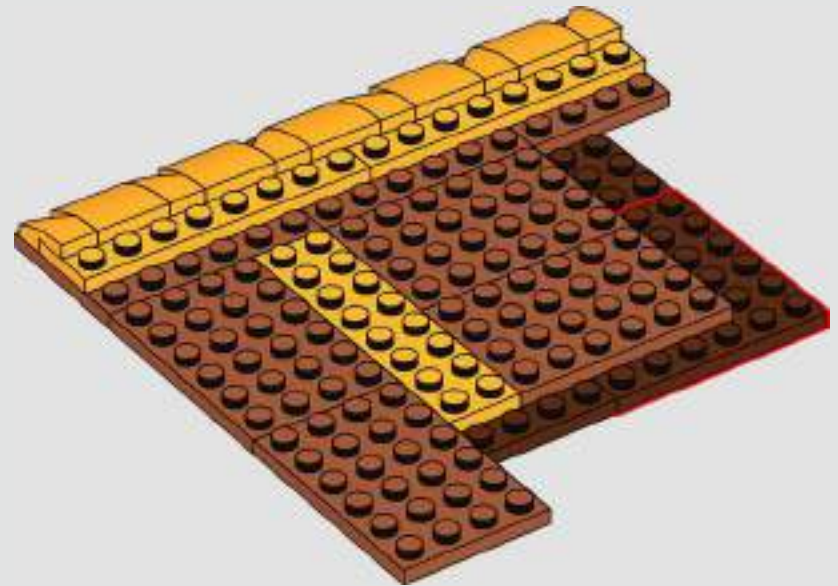





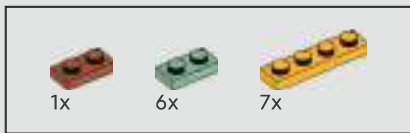

368

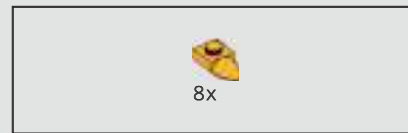
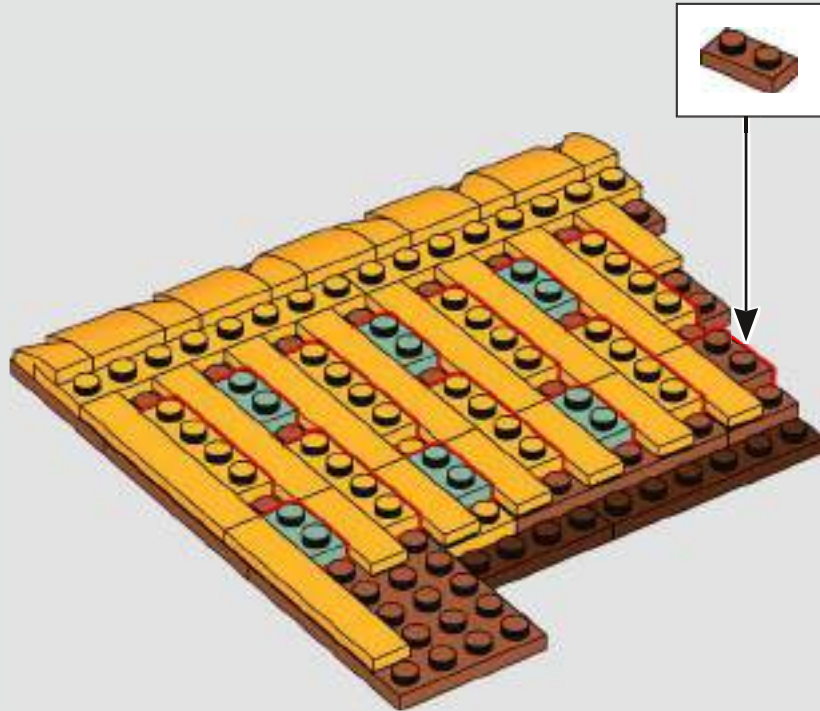

369

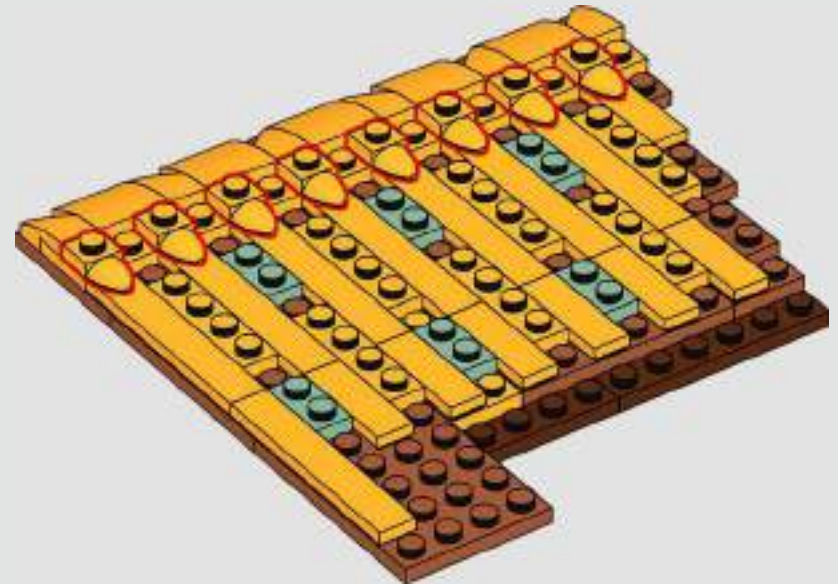



370

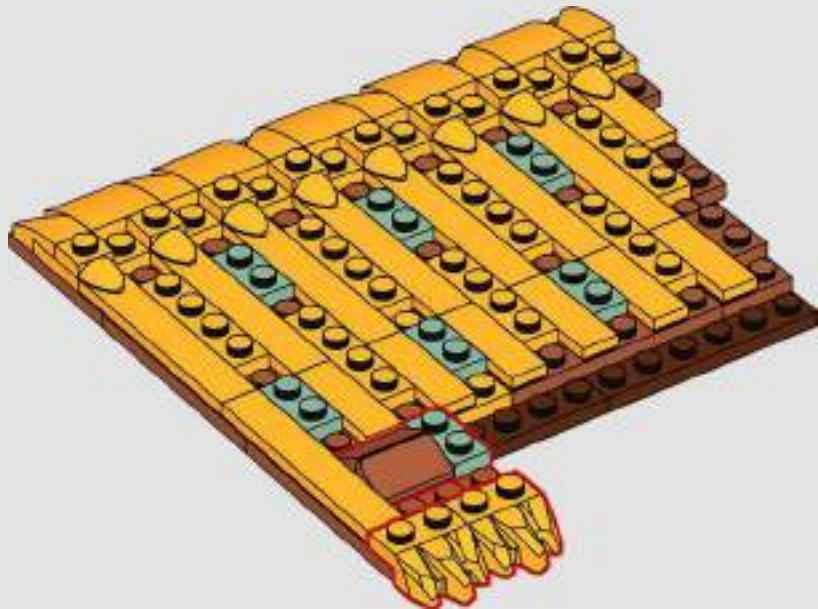

371

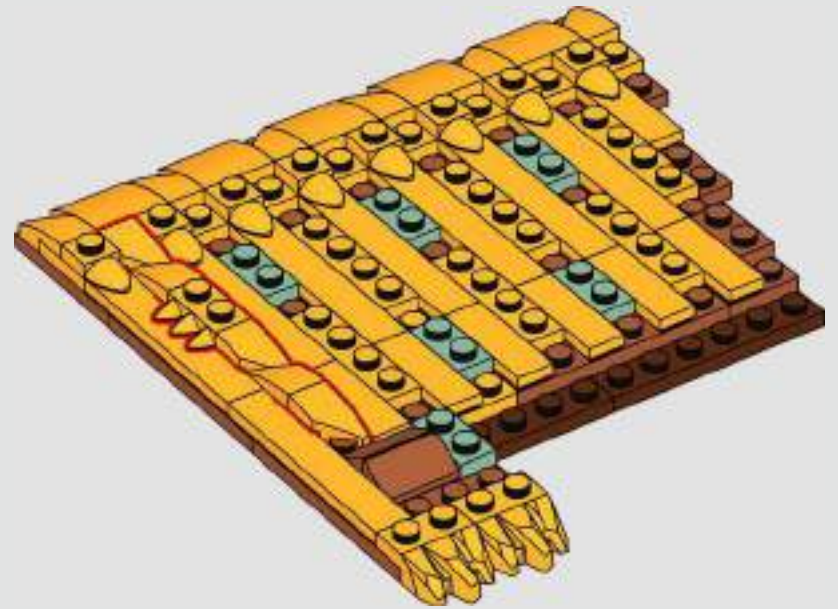



372

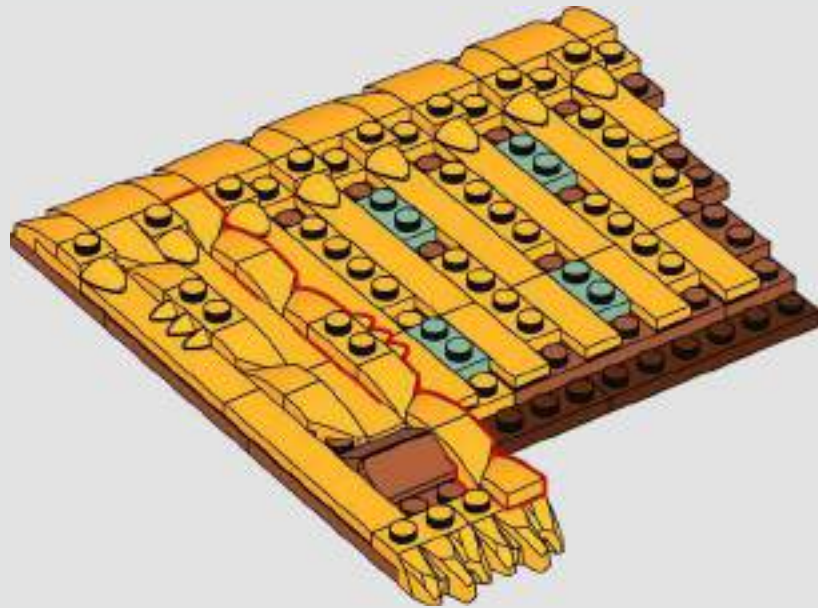

373

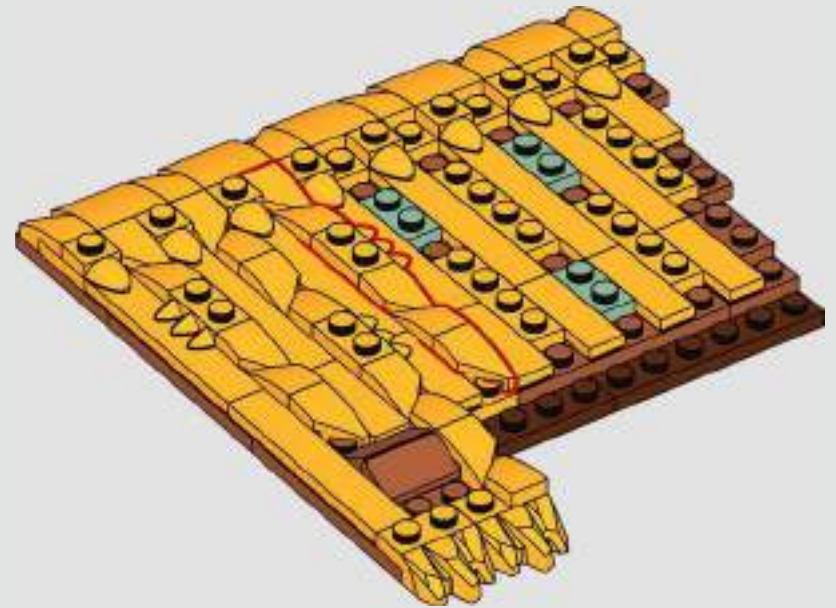





374

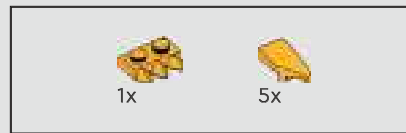
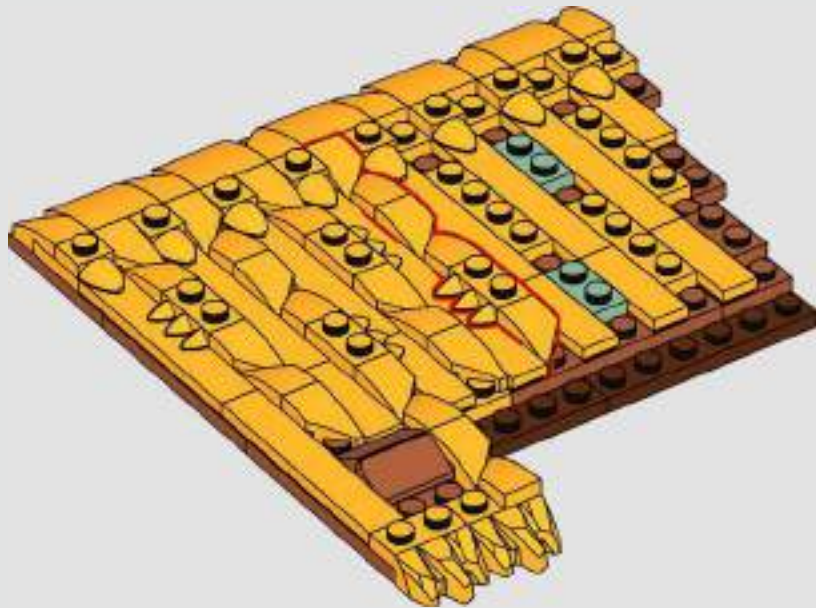

375

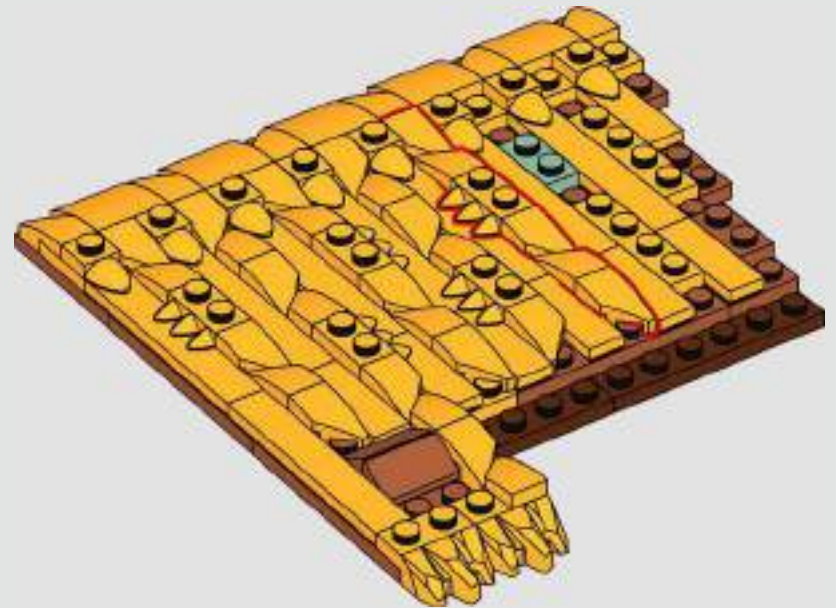



376

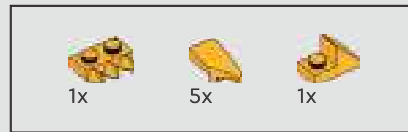
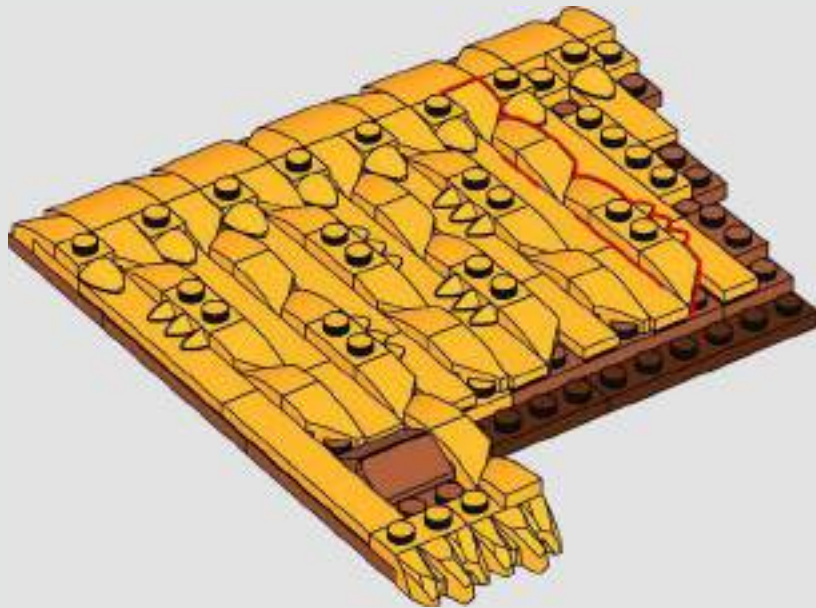

377

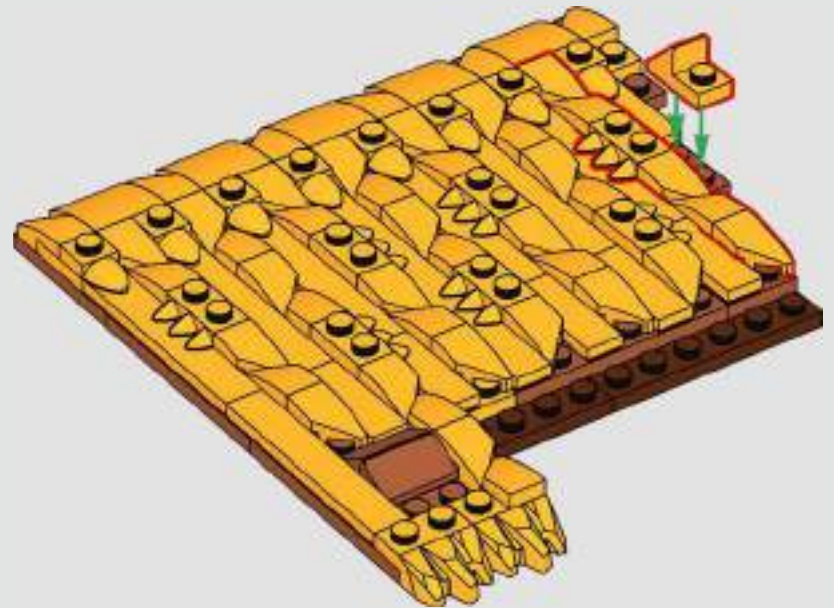



2x

378

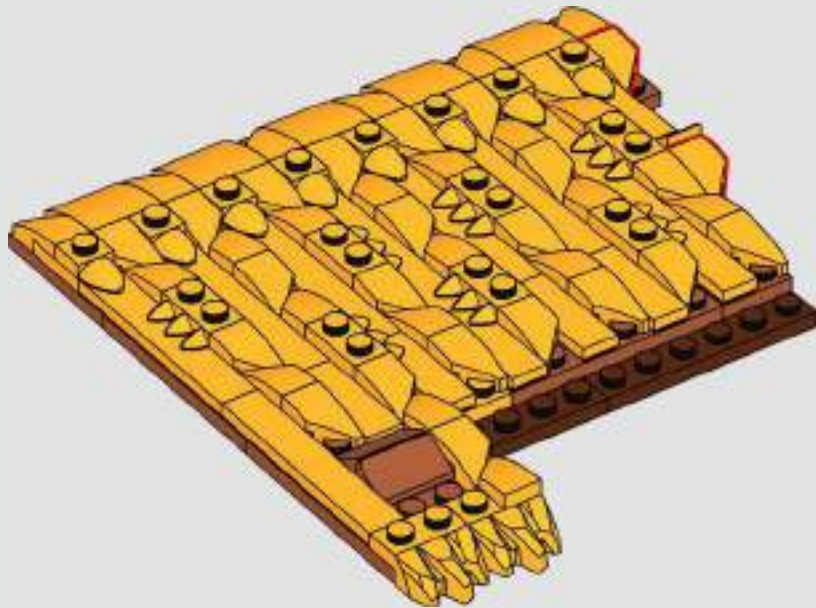

5x

379

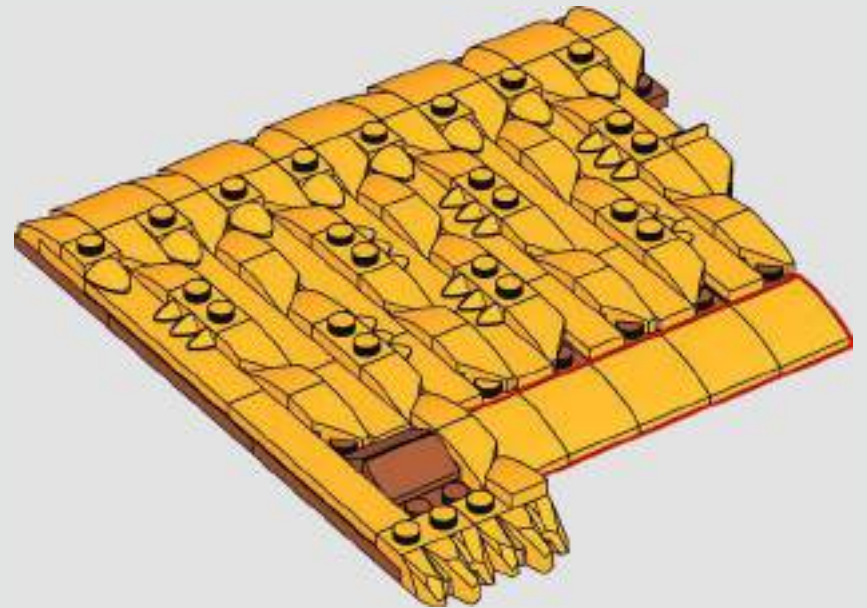





380

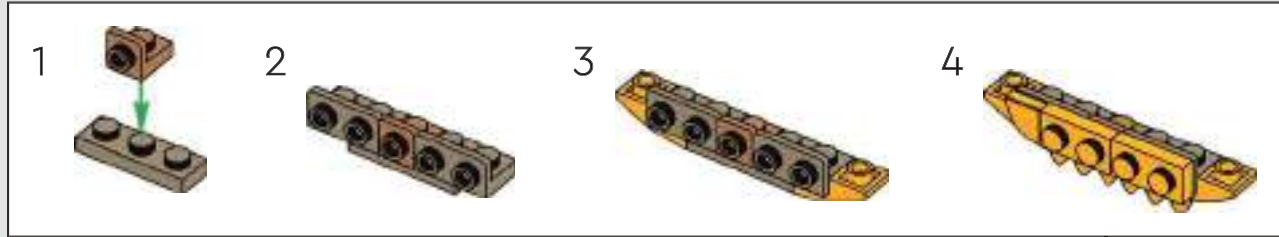

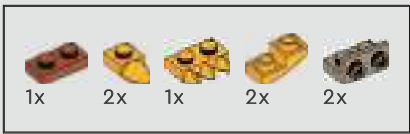

381

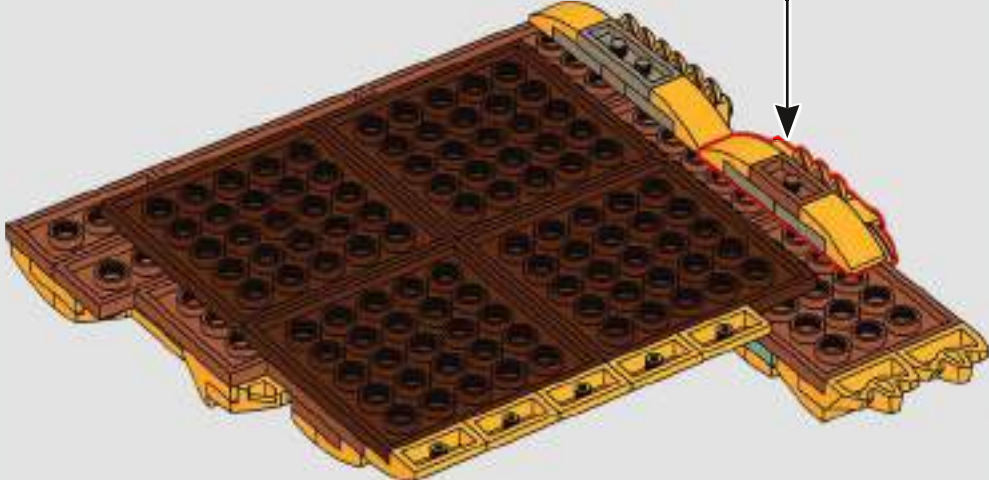
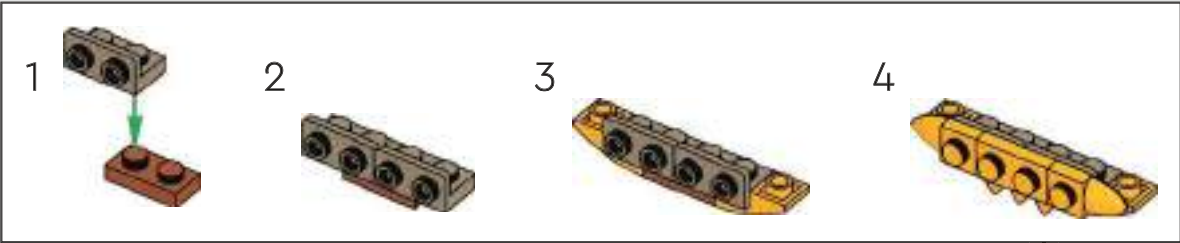

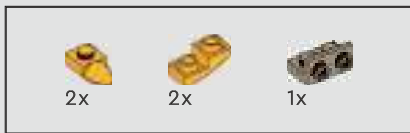

382

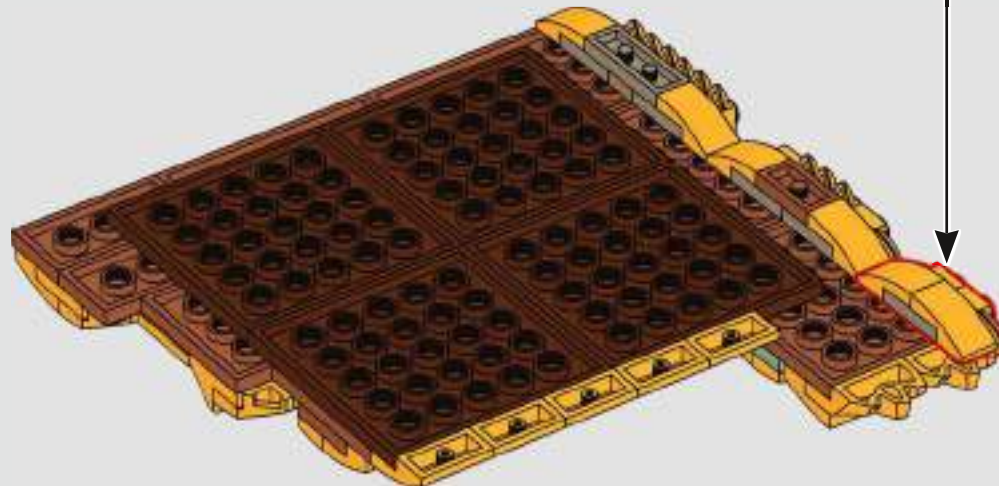





383

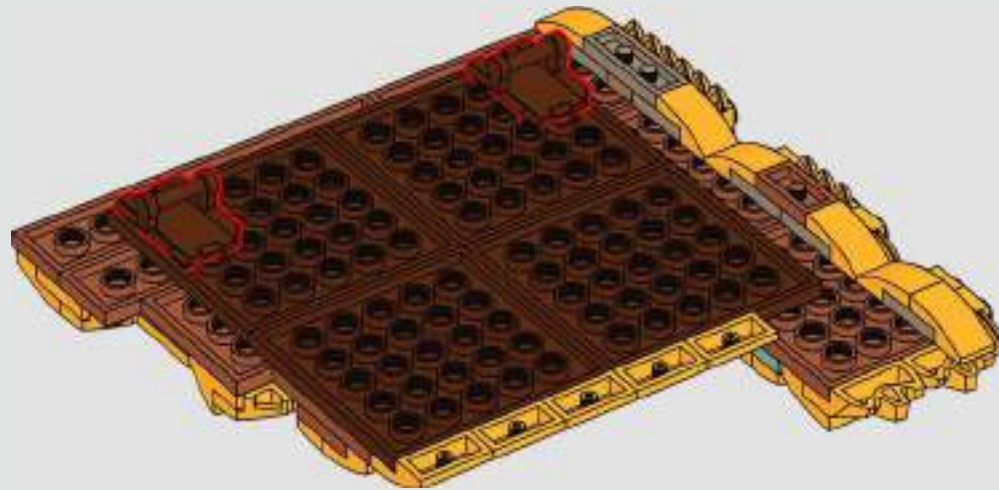

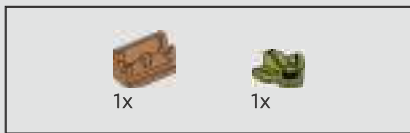

384

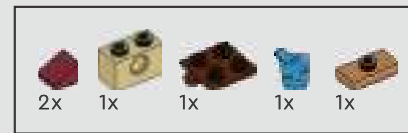
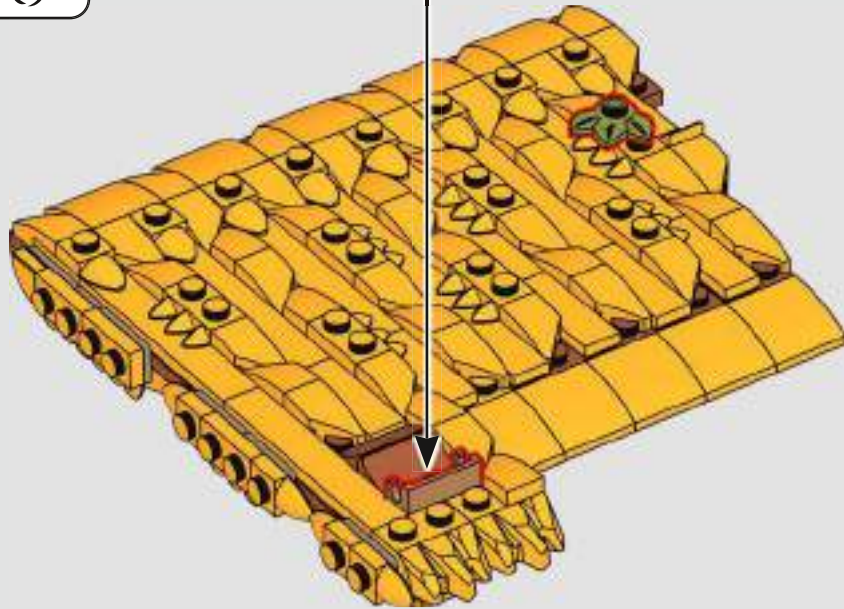

385

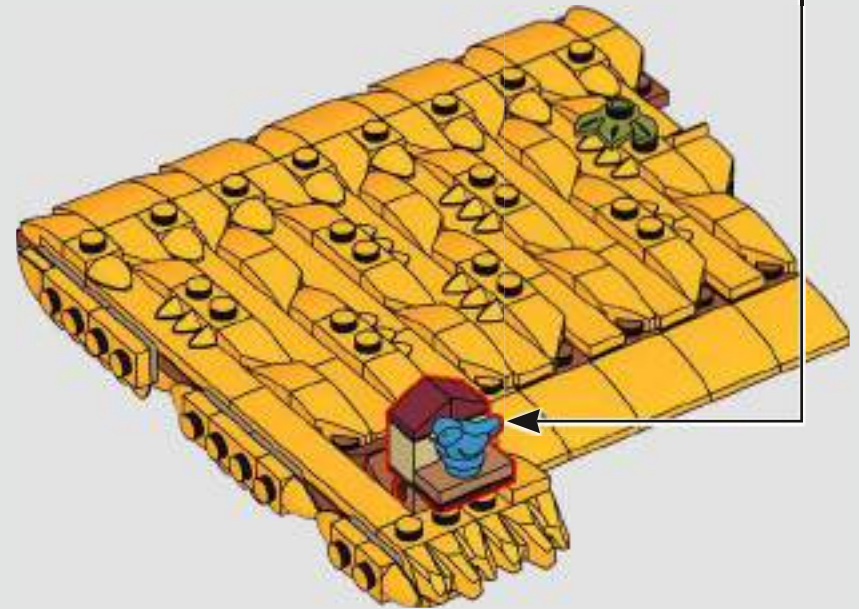
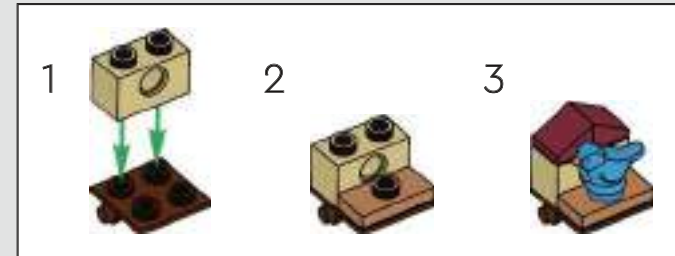



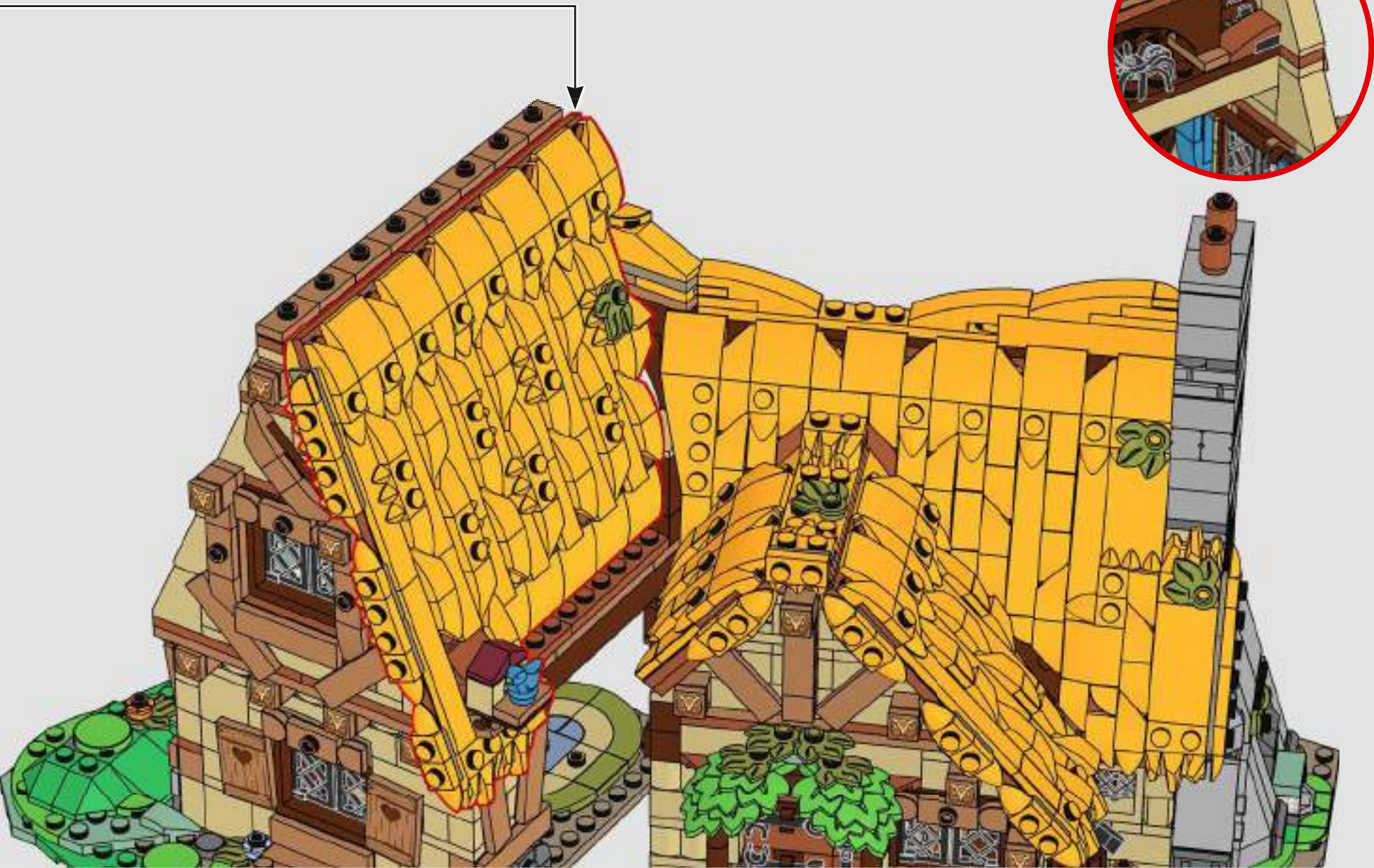



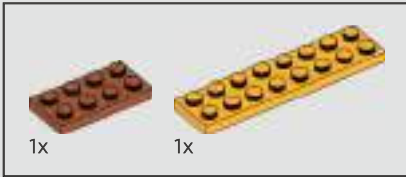

387



388

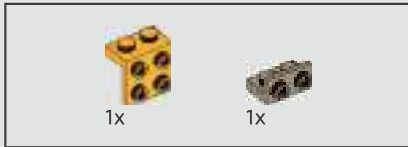

389

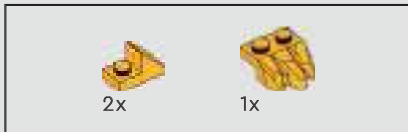
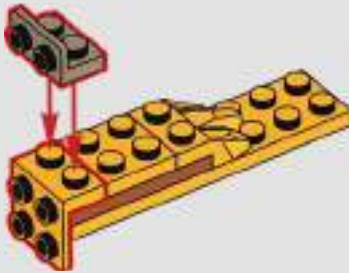

390



391

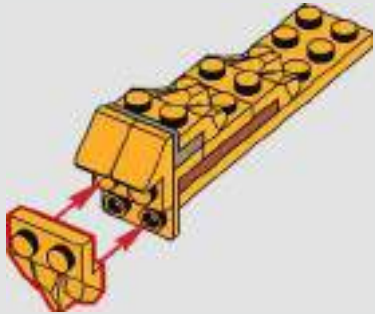

392

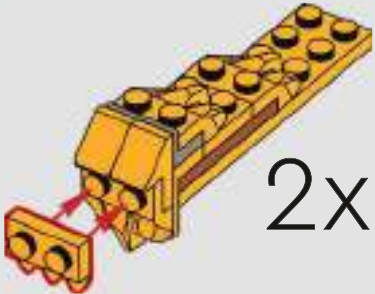







1x

394







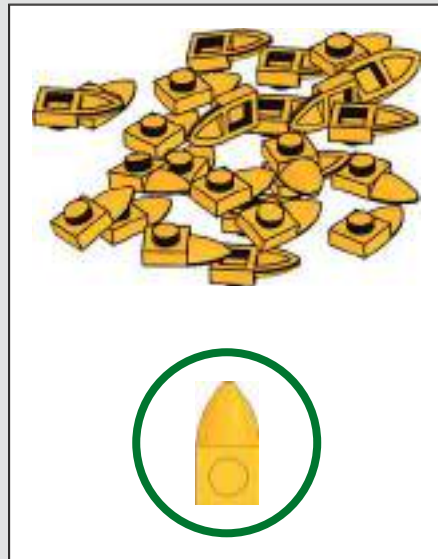
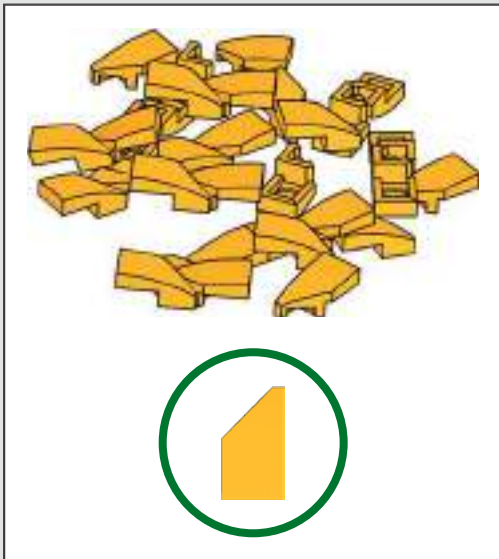



2x

395

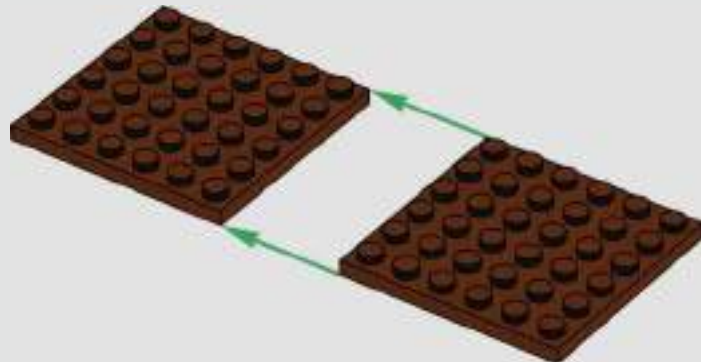

1x

396







397

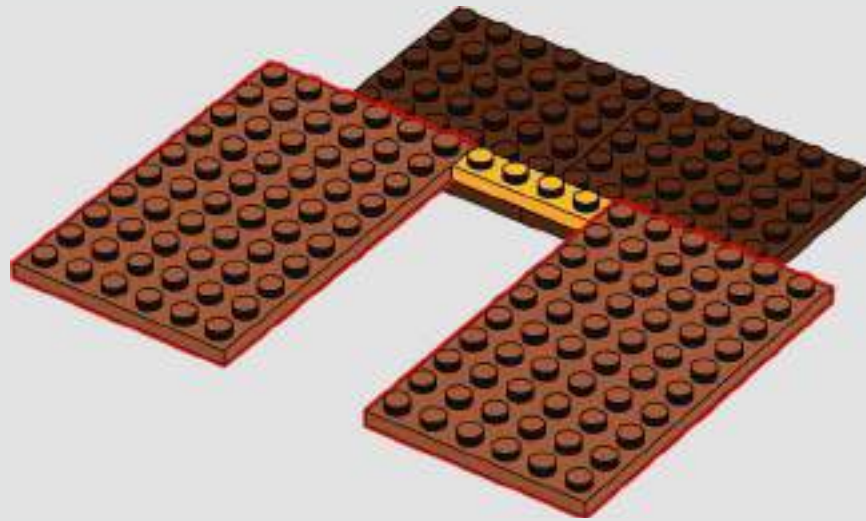

398

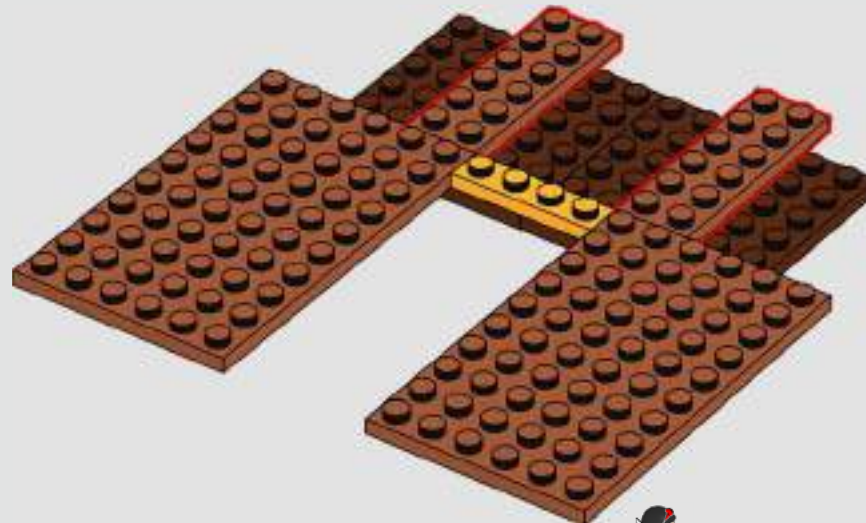



399

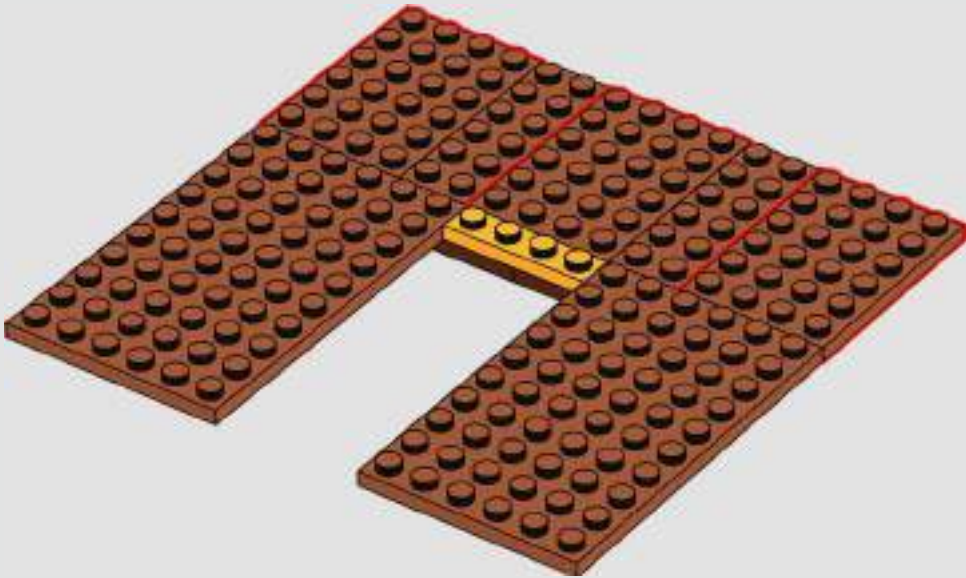

400

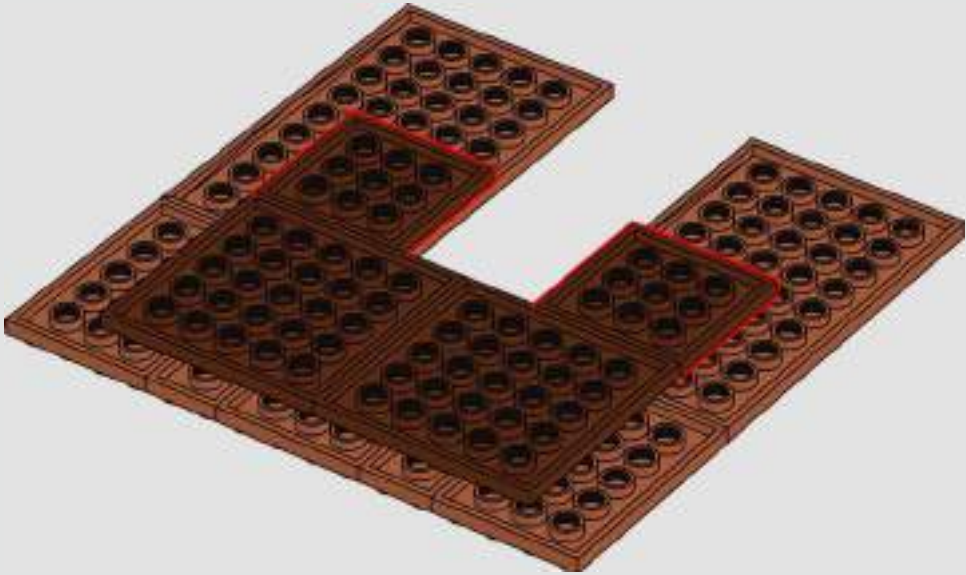

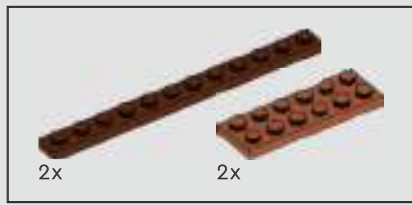

401

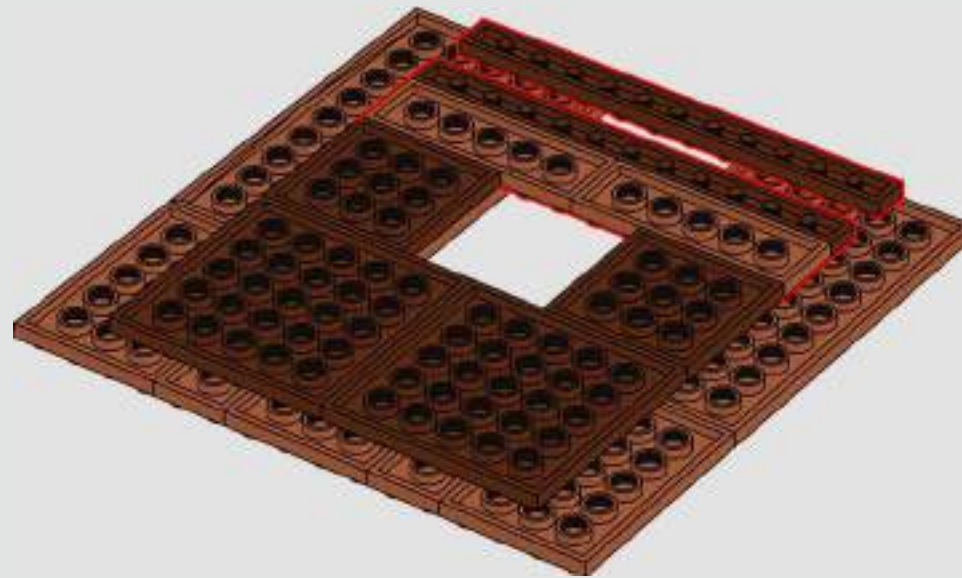



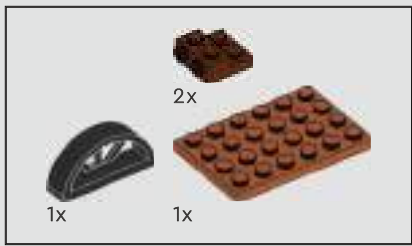

402

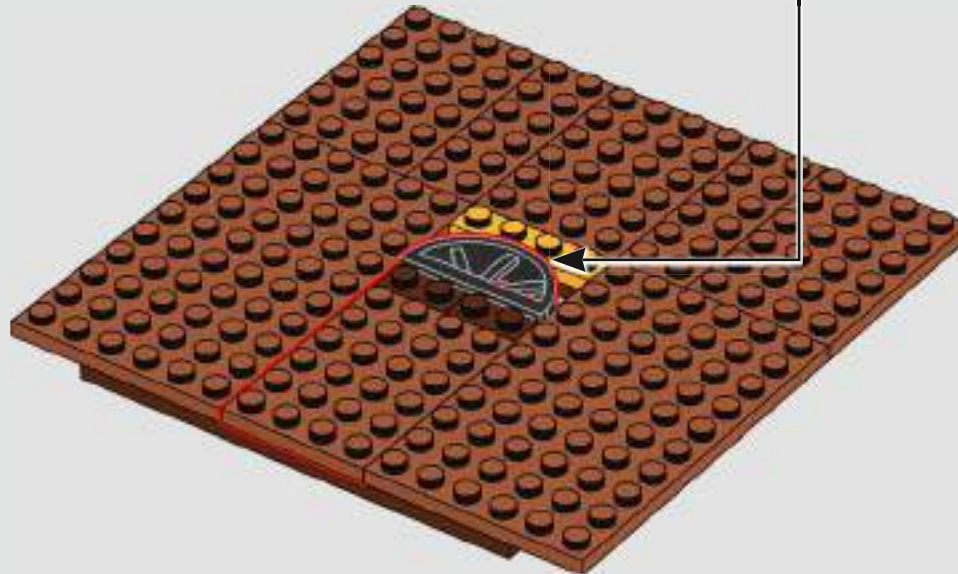

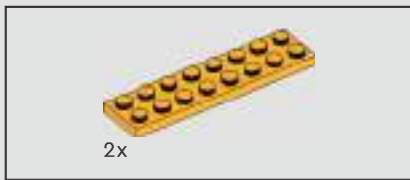

403



404

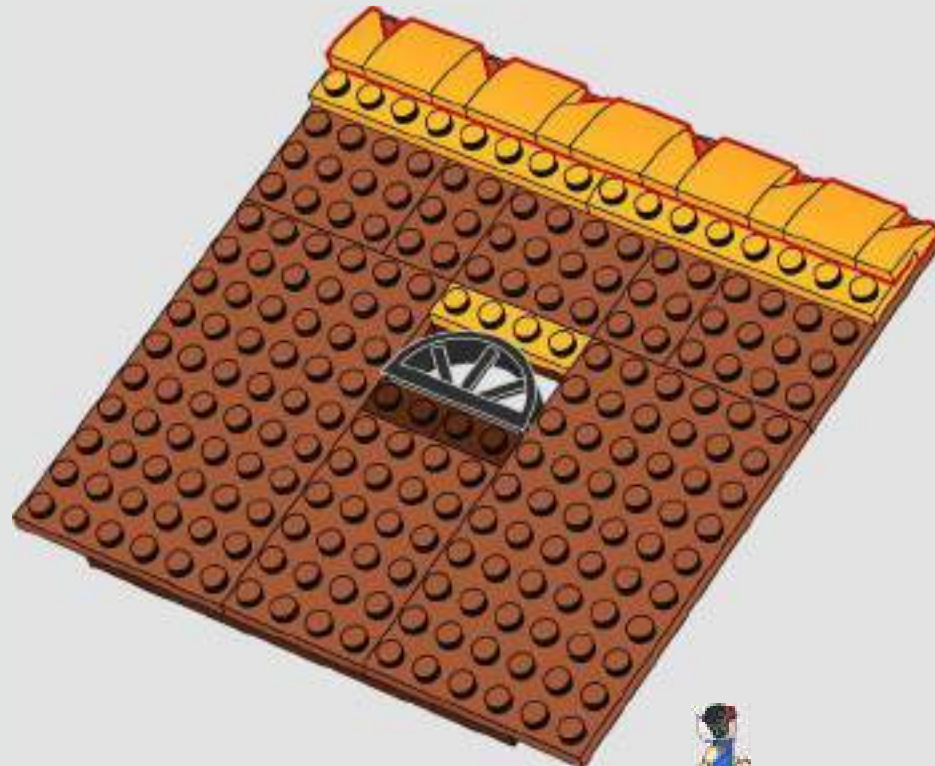

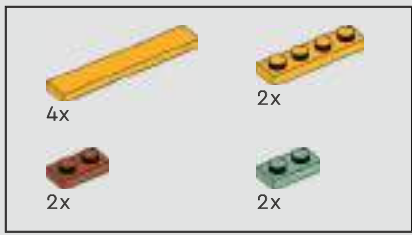

405

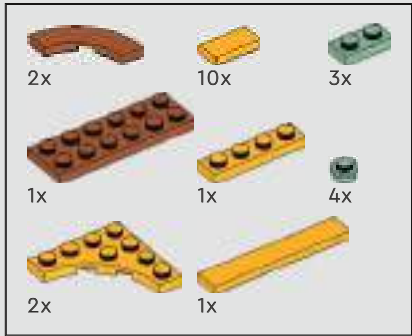
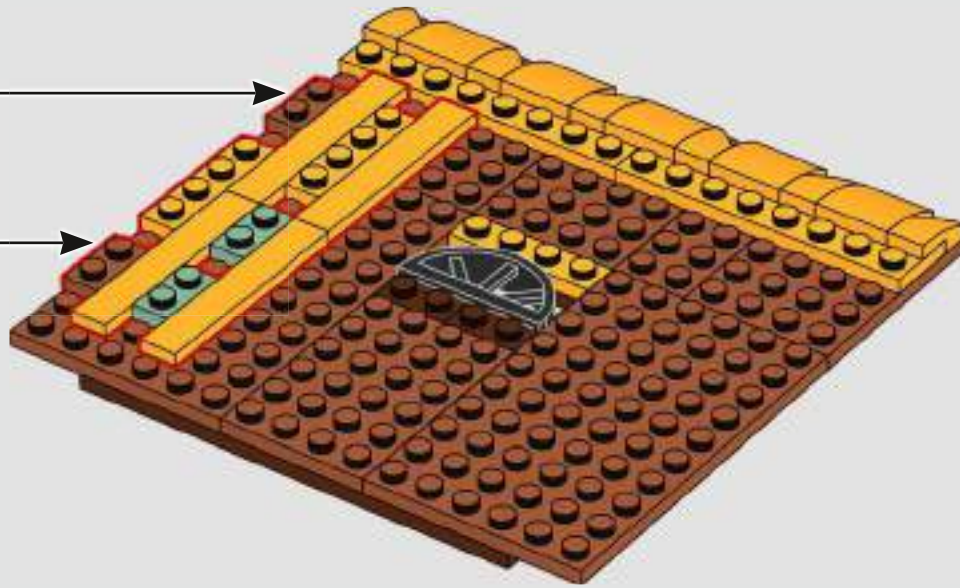

406

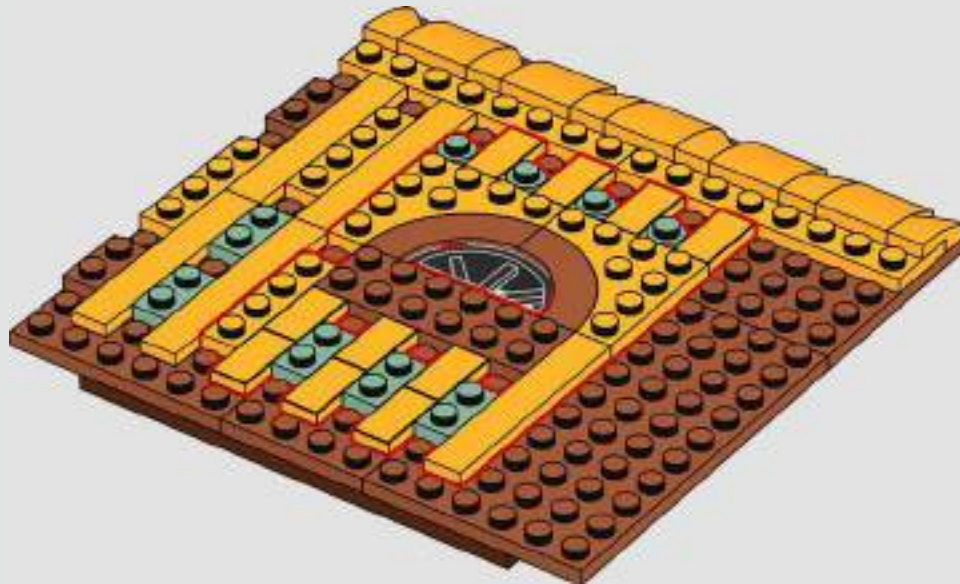



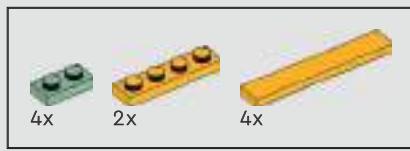

407

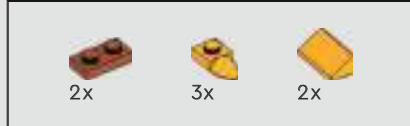
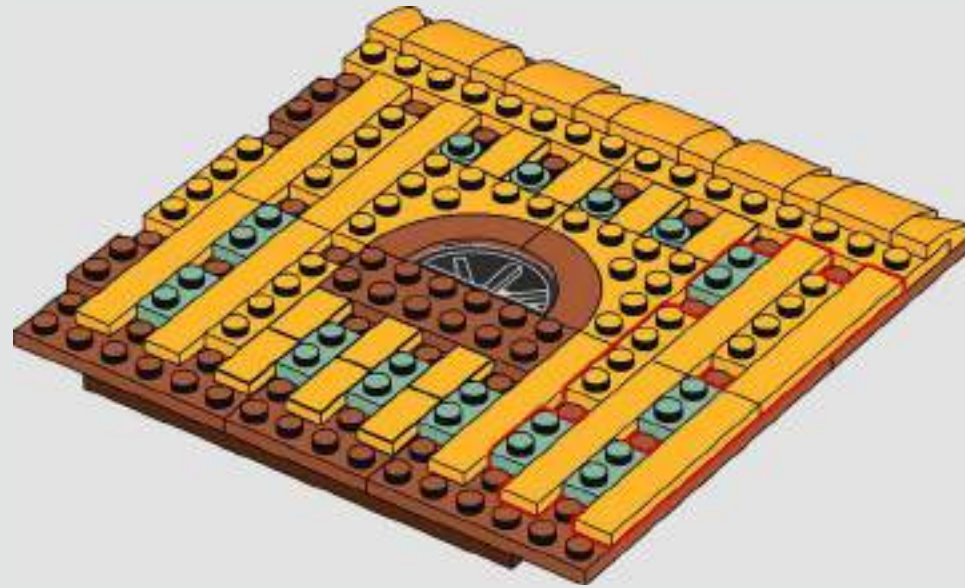

408



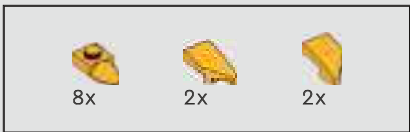

409

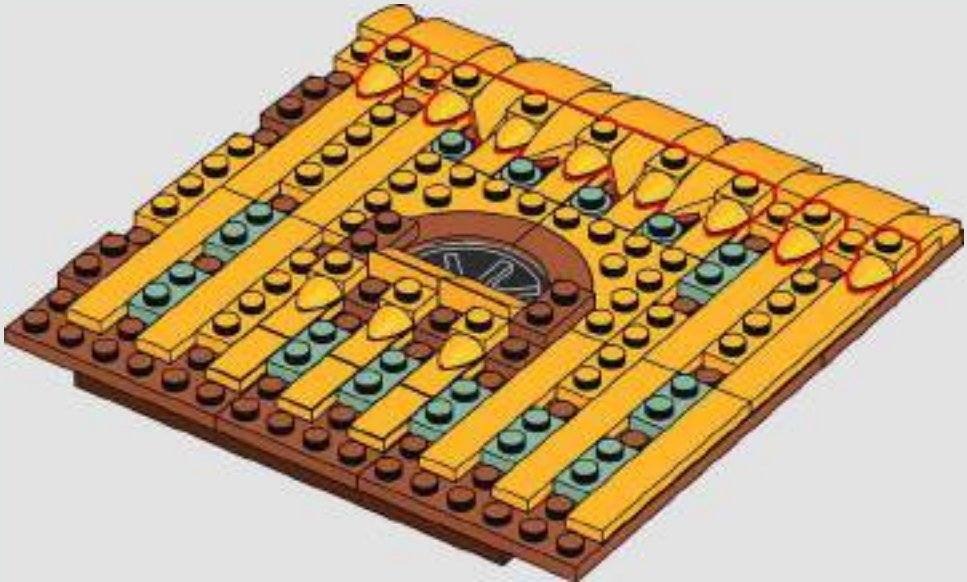

410

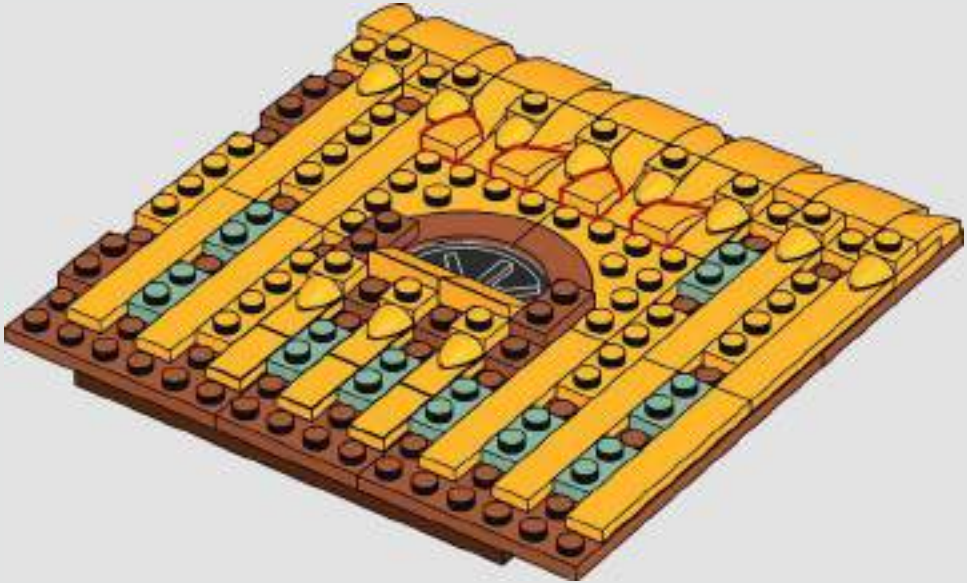



411

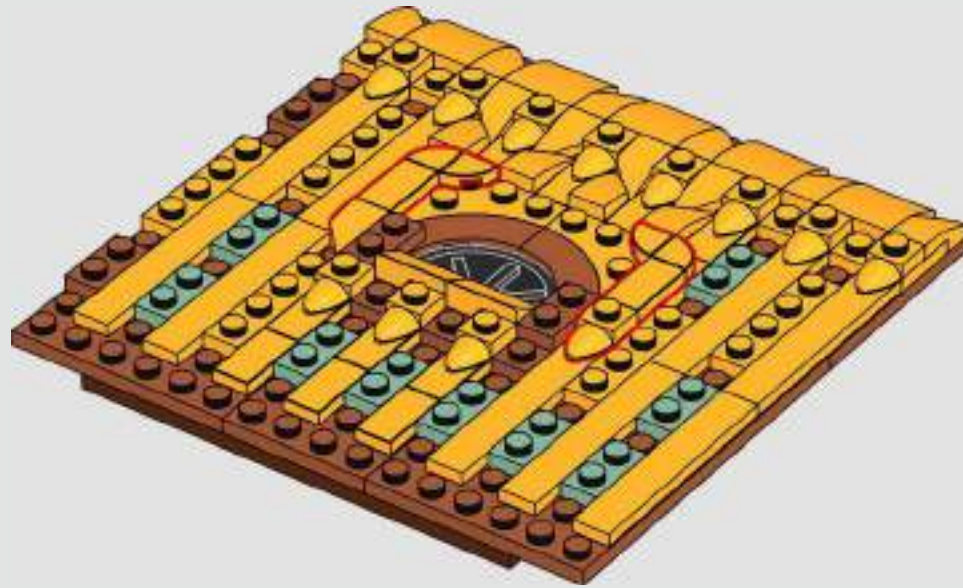

412

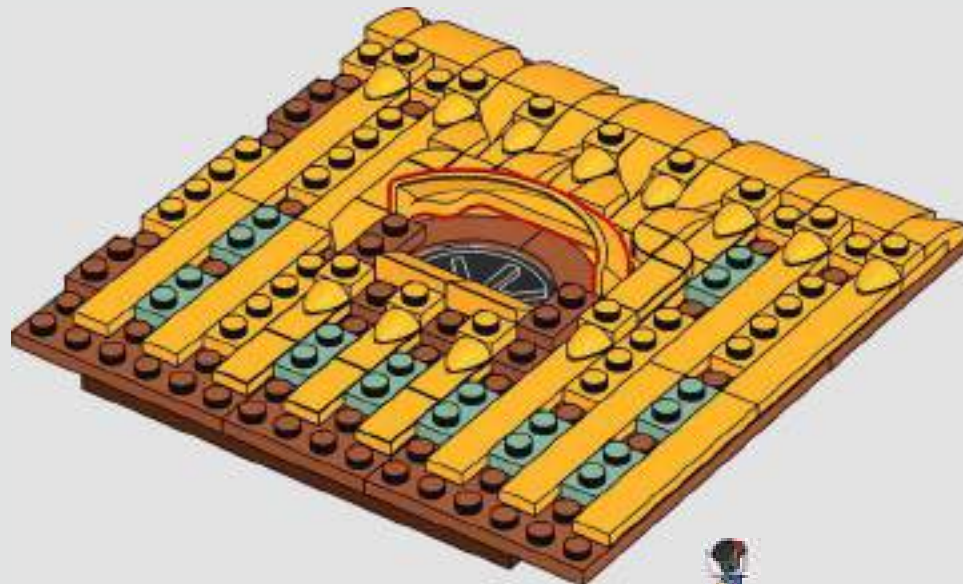



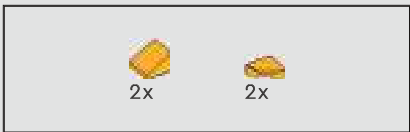

413

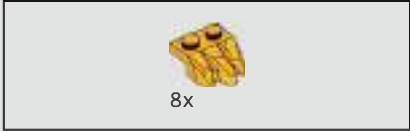
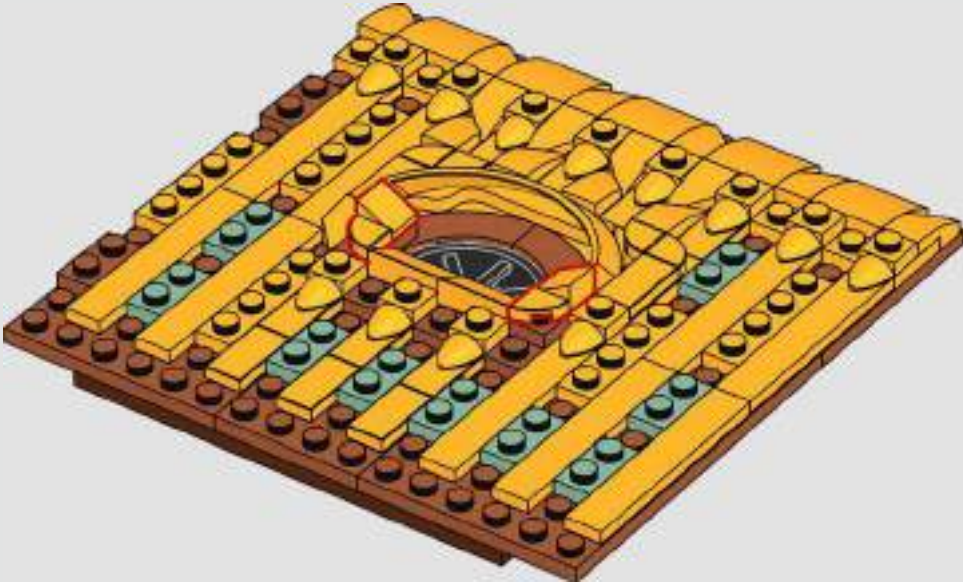

414

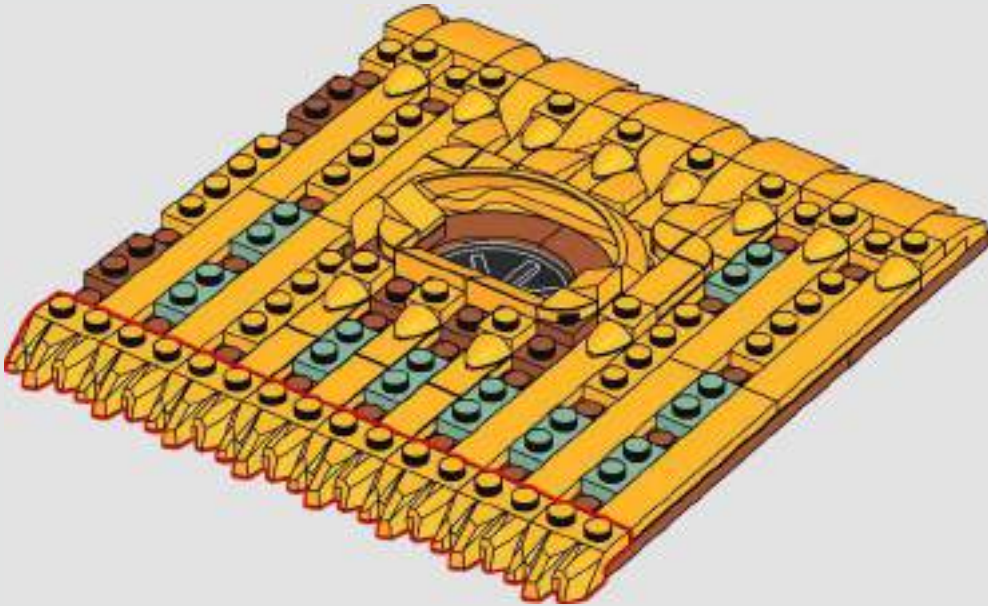

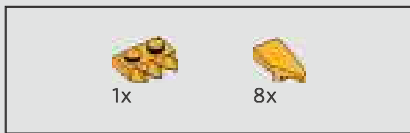

415

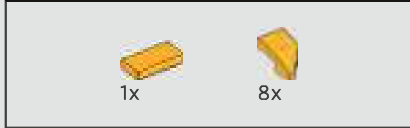
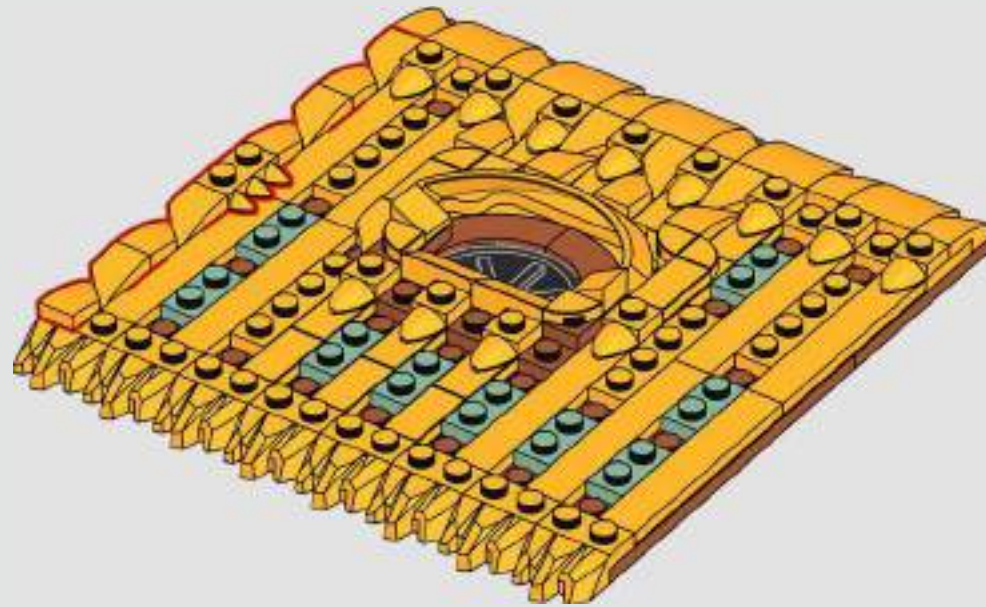

416

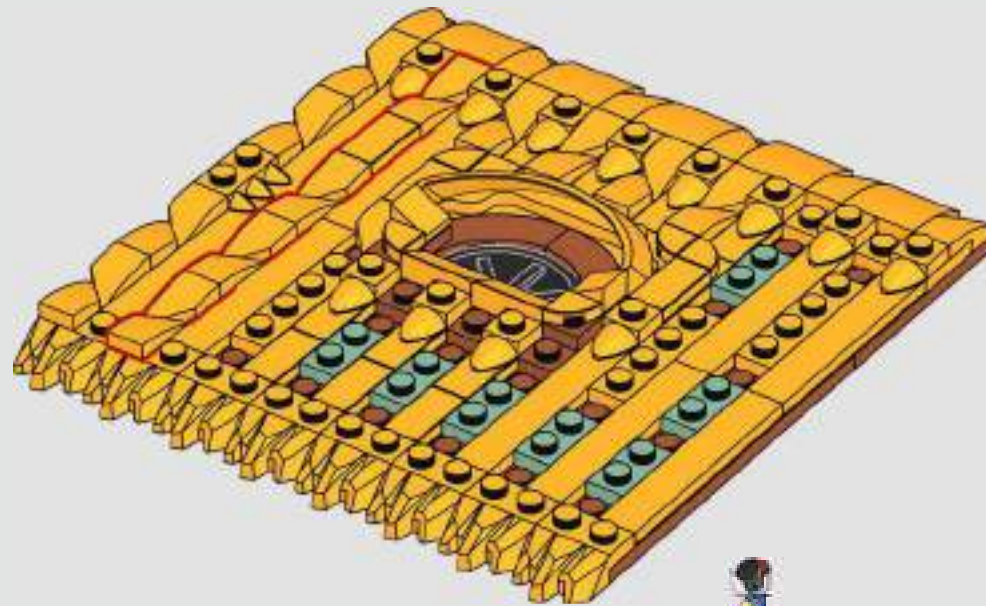





417

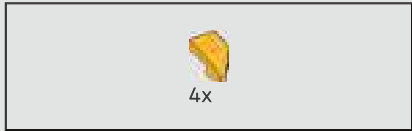
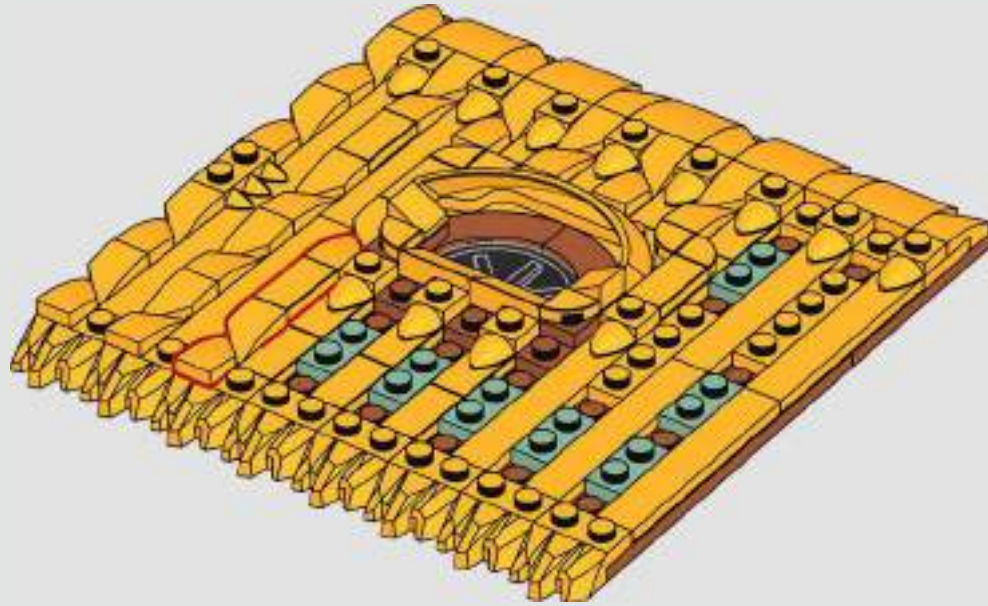

418

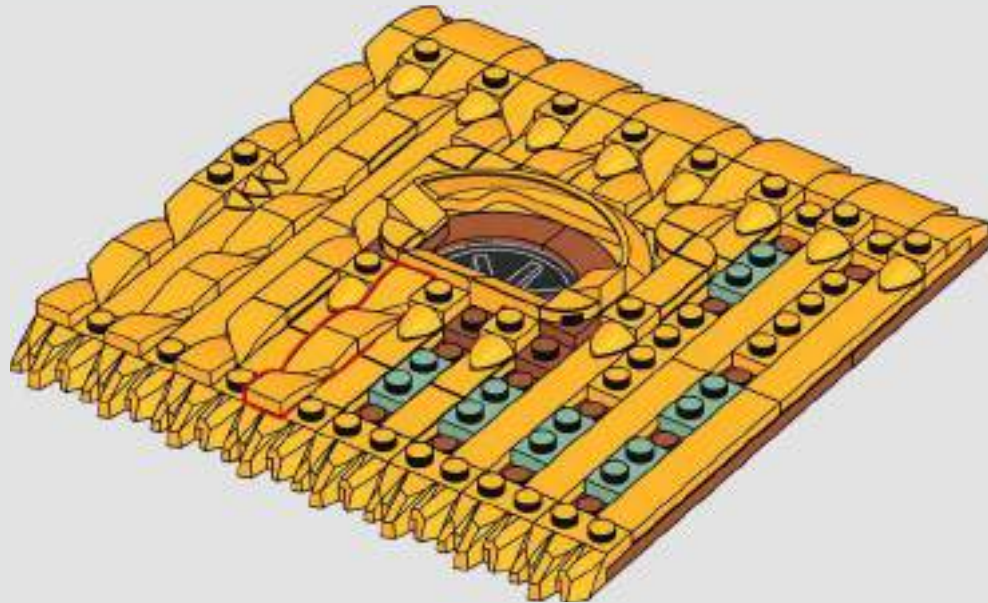





419

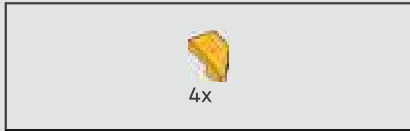
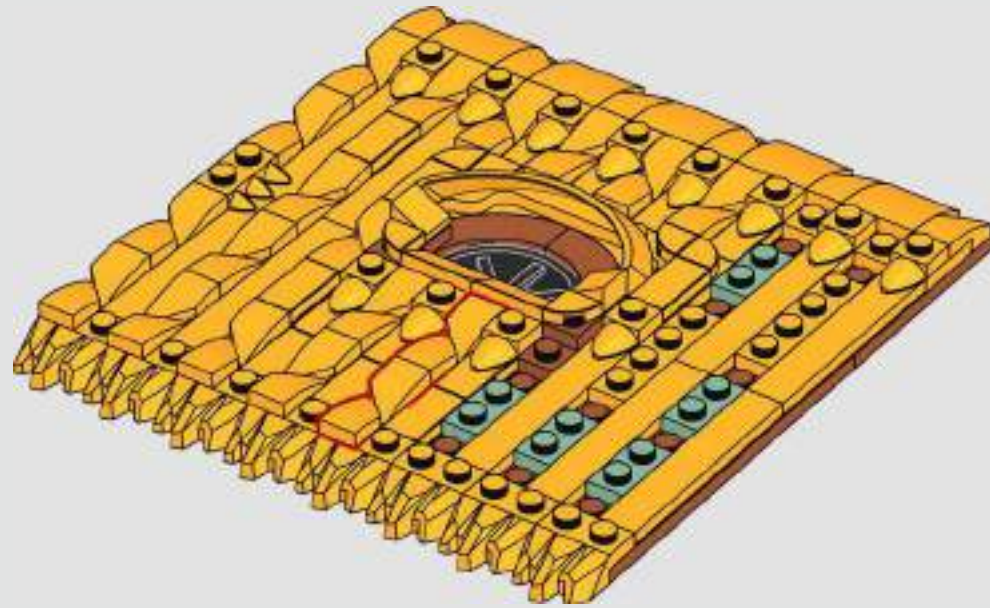

420

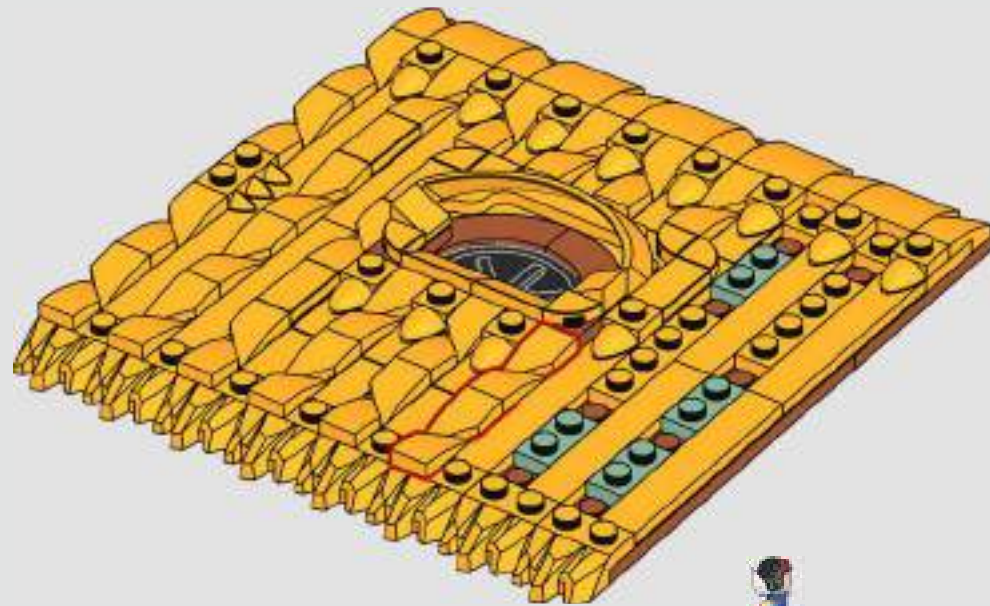

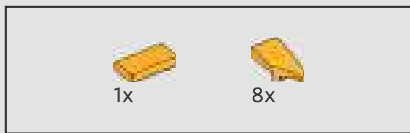

421

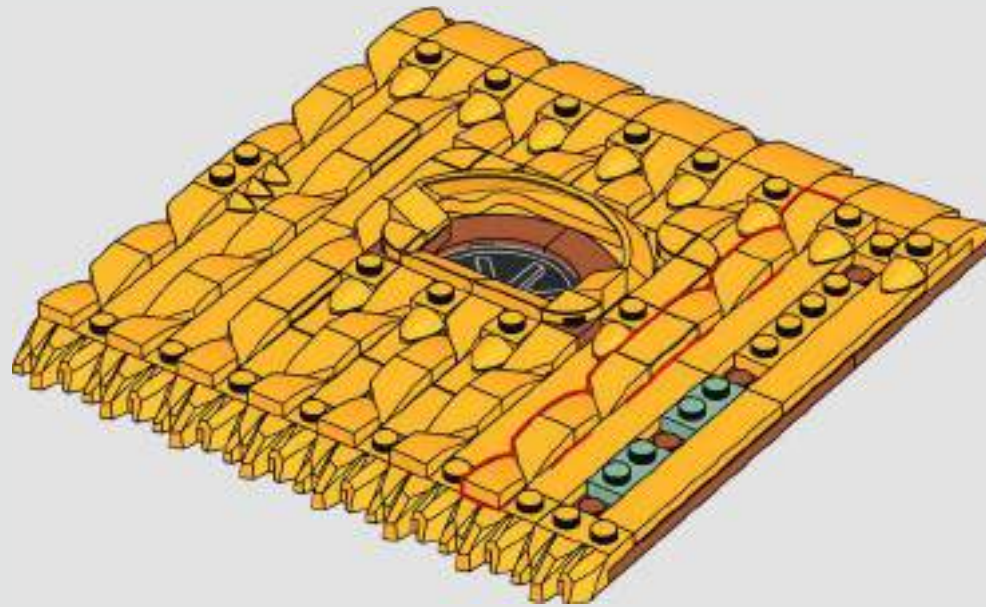

422

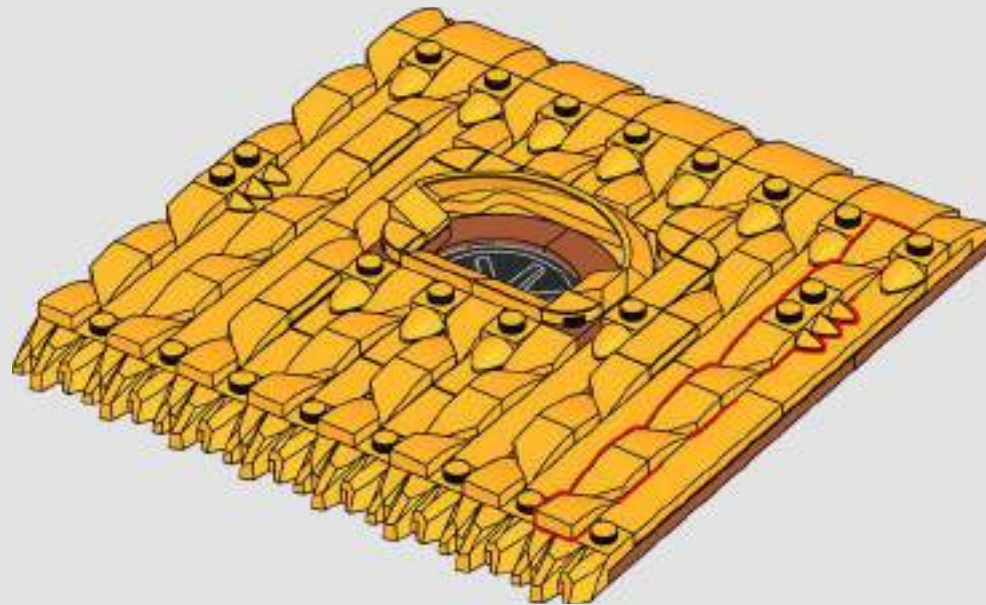



423







424

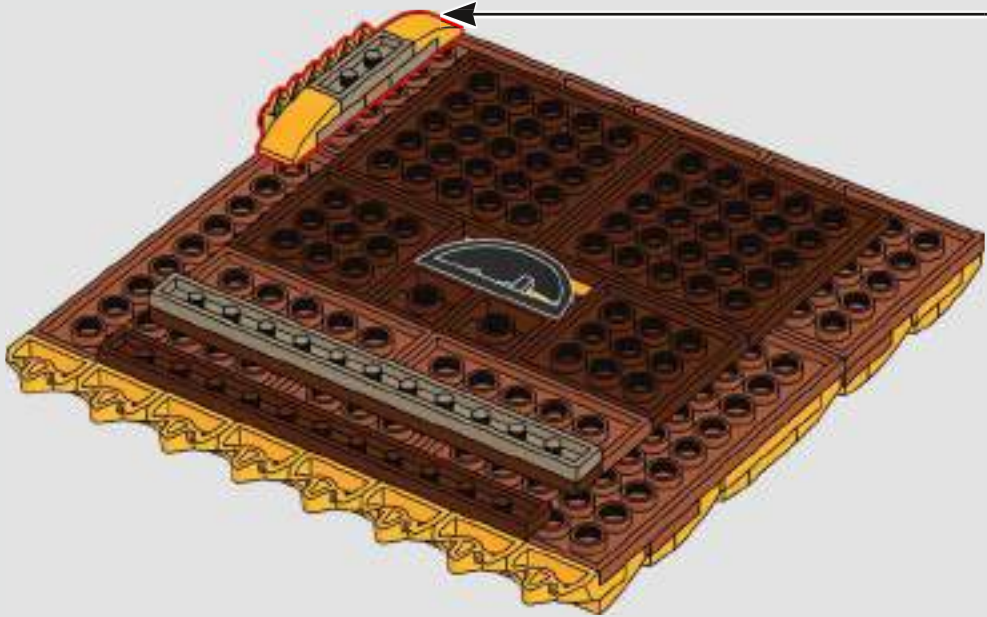
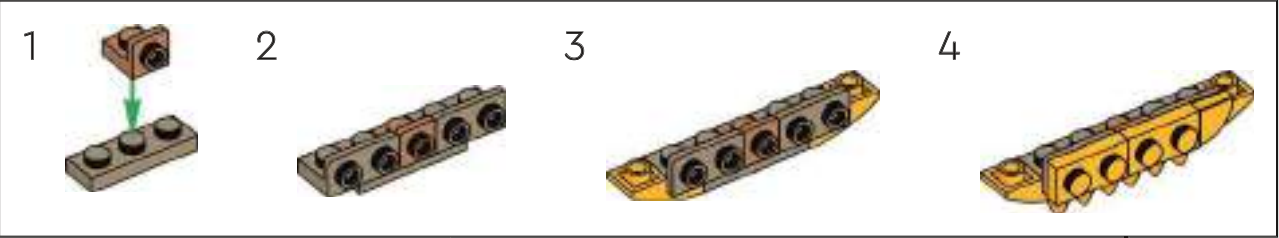

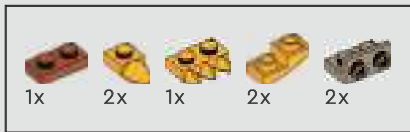

425

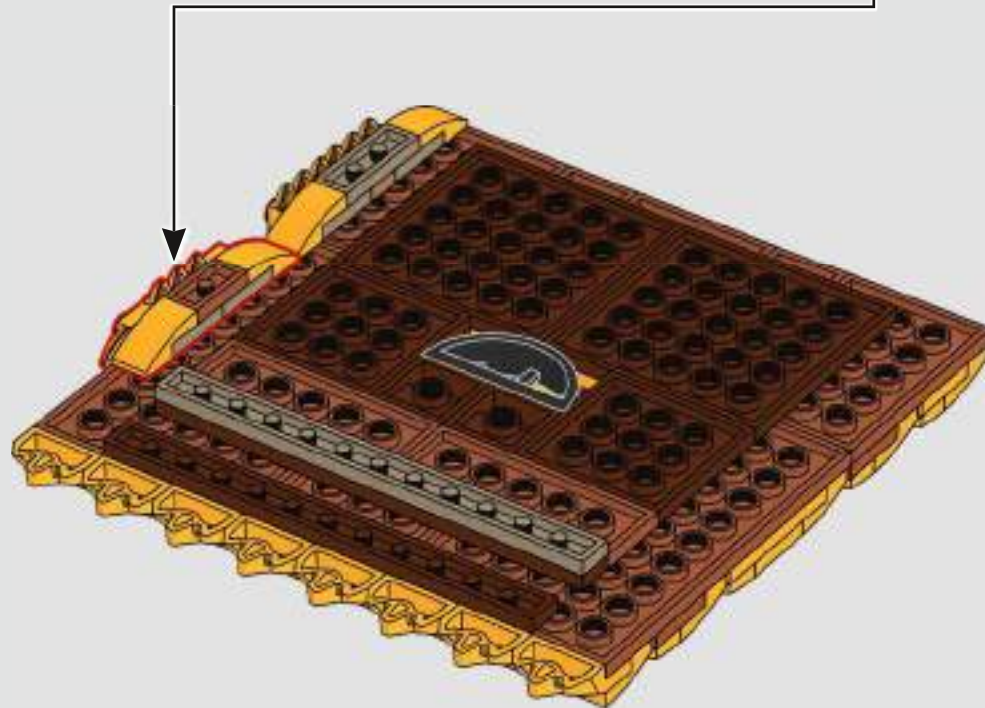
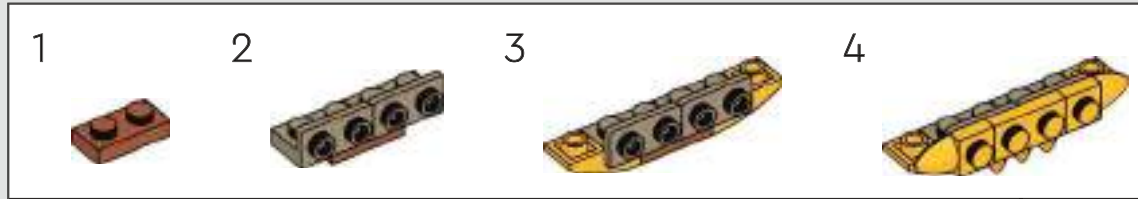

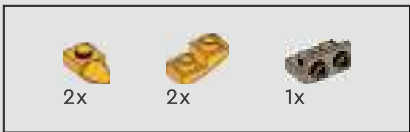

426

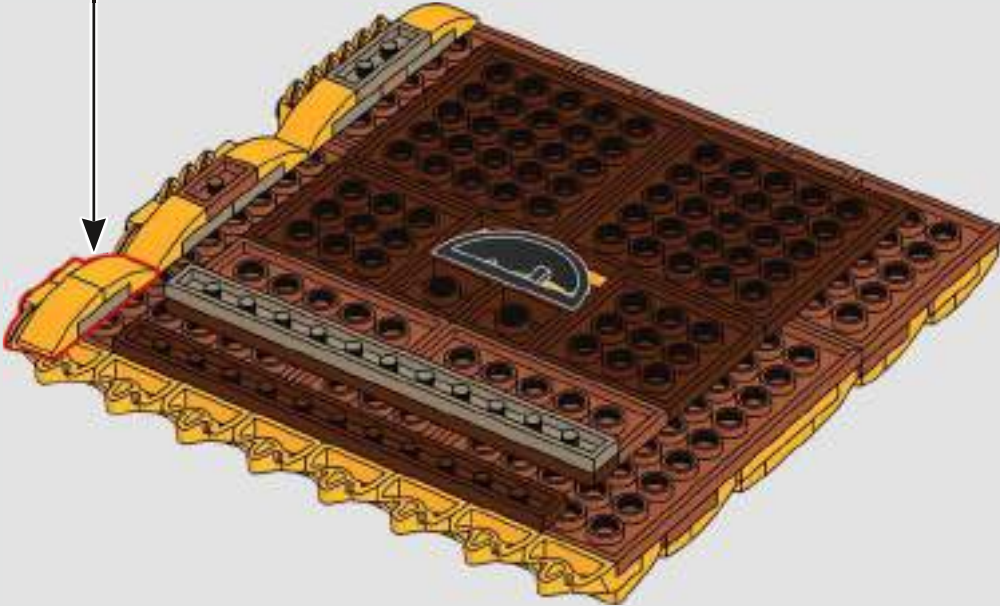



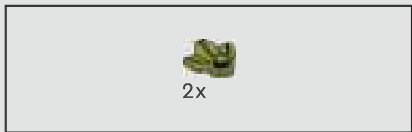

427

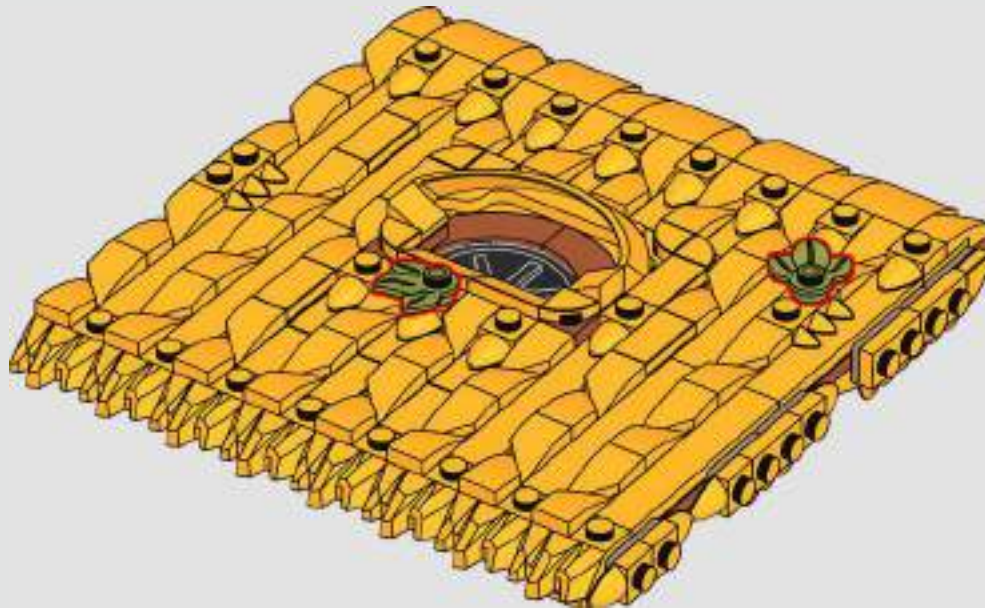









429

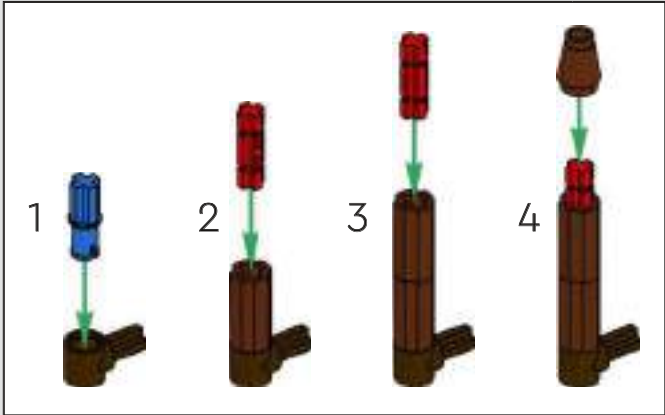



430



431



432

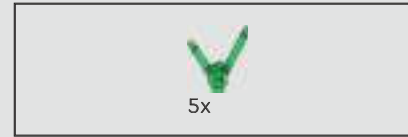

433

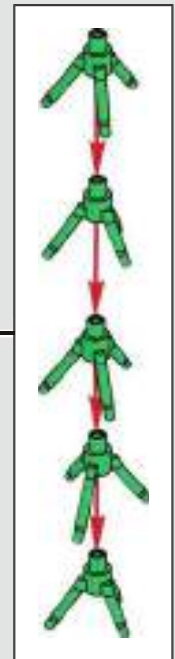









435



436



437

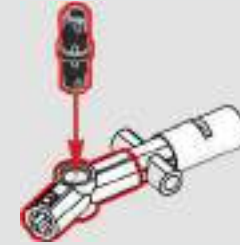

438

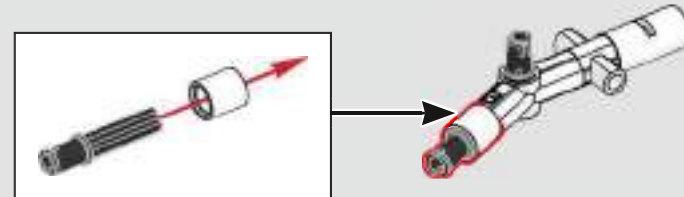

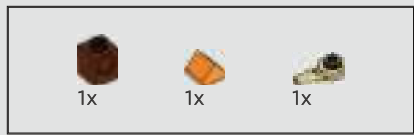

439

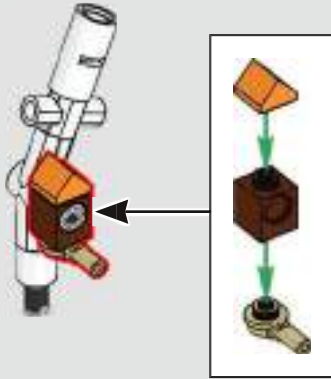

440



441

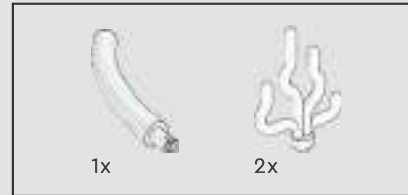
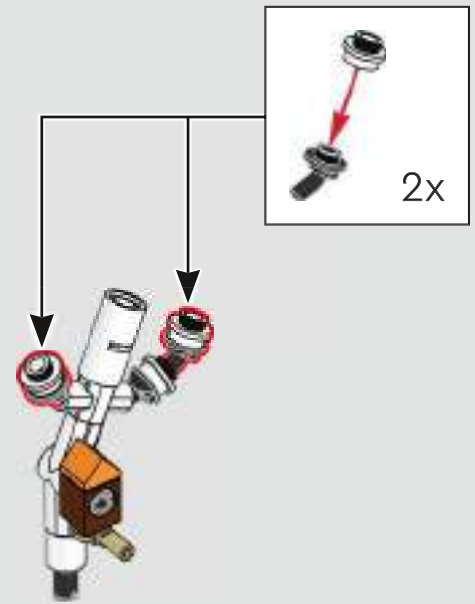

442



443





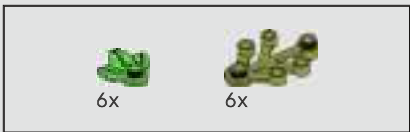

444

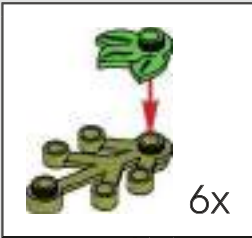

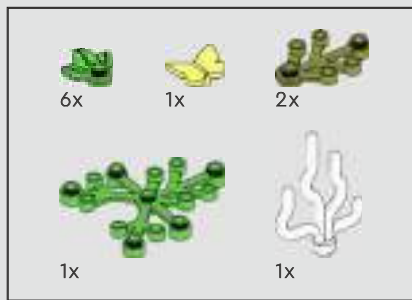

445

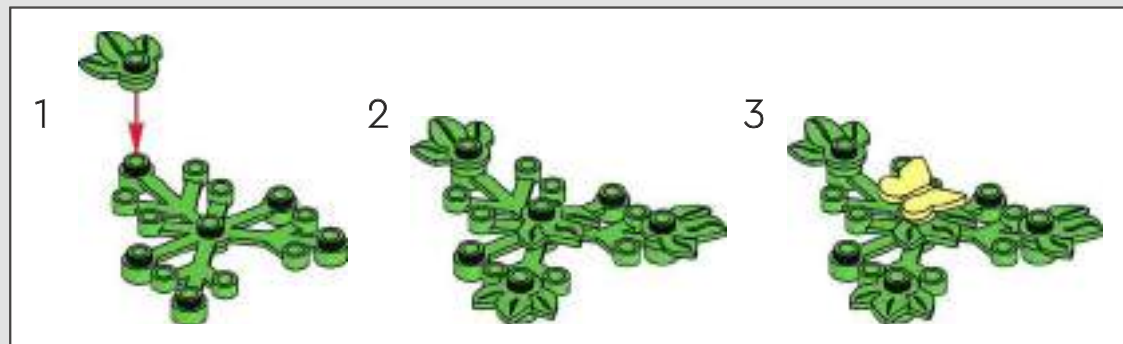

1



2

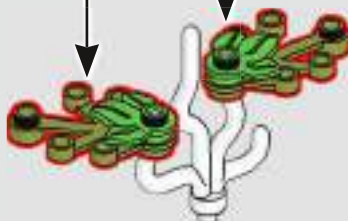

3

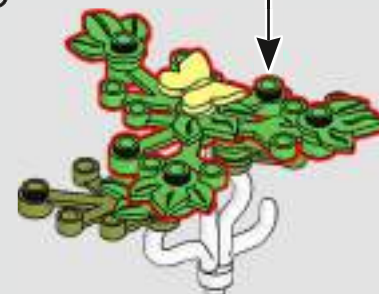







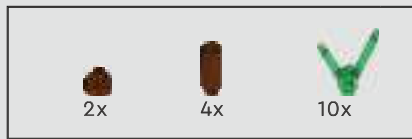

446

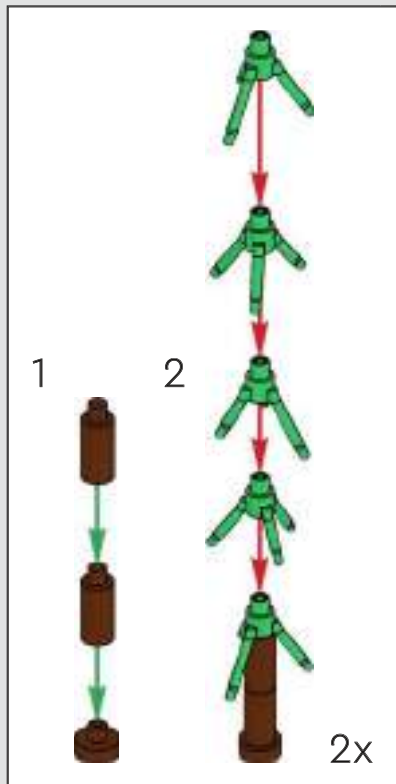



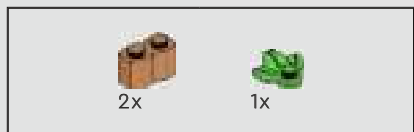

447





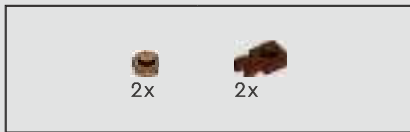

448





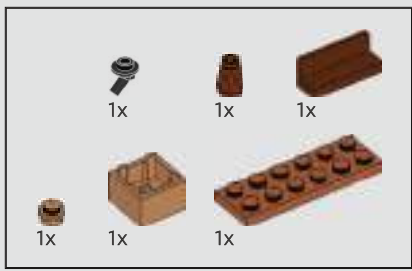

449

1



2



3







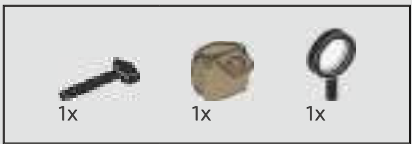

450





-  1x
-  1x
-  1x
-  1x

451



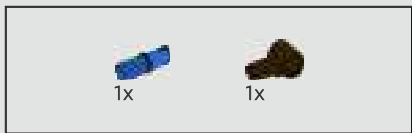

452

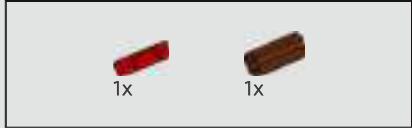

453



454

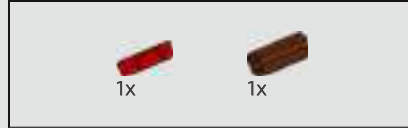

455



456

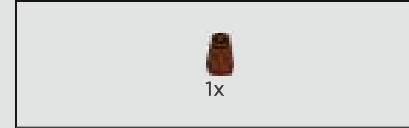

457





458







459



460



461

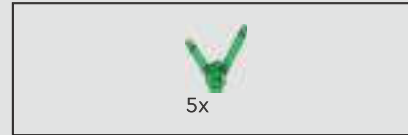

462

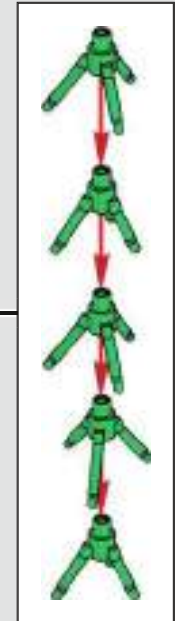

463







1

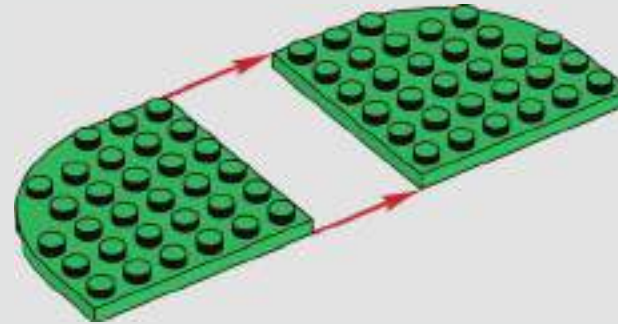

2

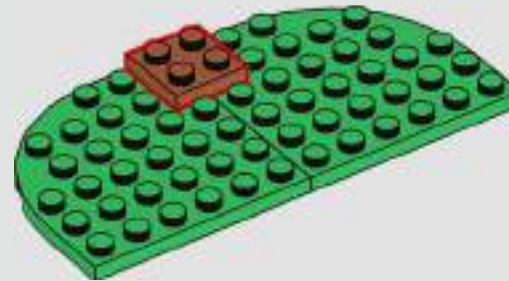



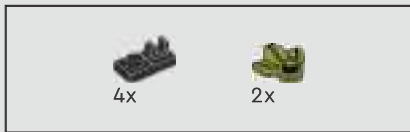

3



4



5



6





7



8



9



10





11

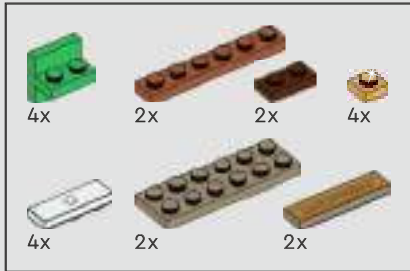

12

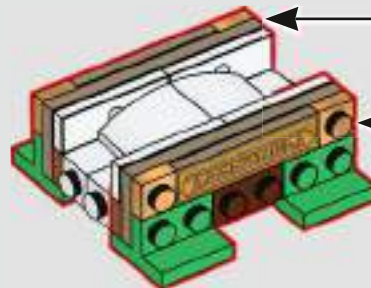
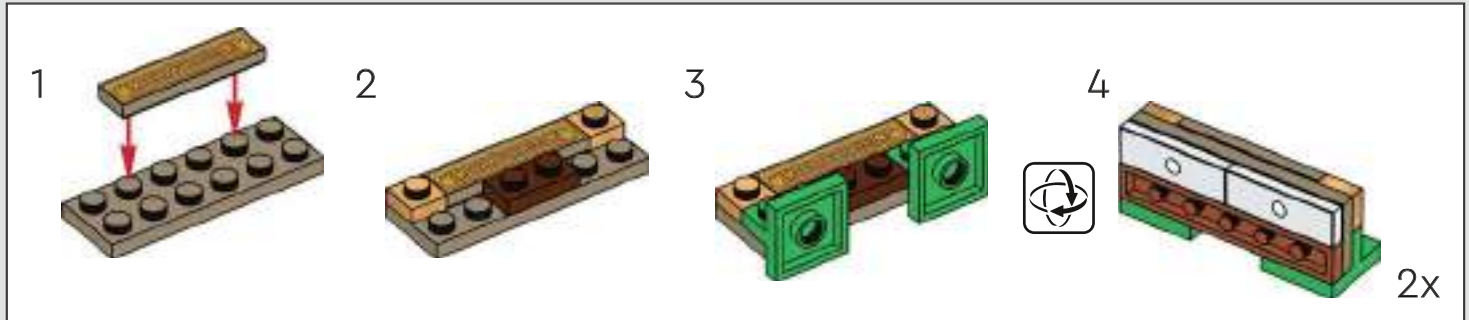



13

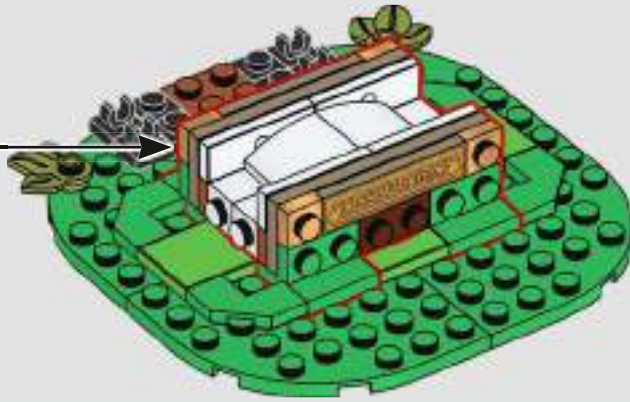

14

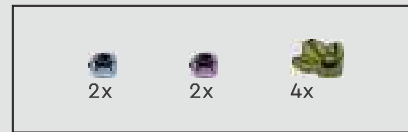
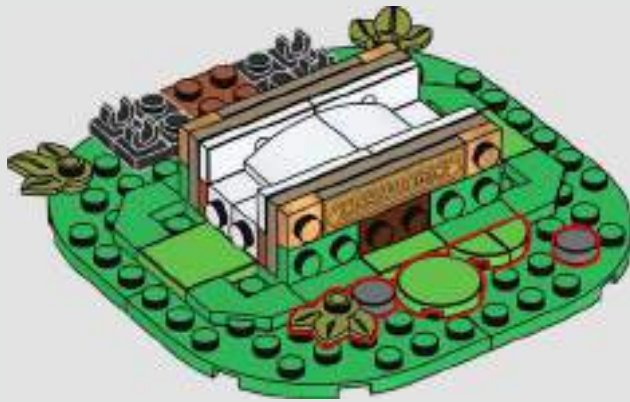

15

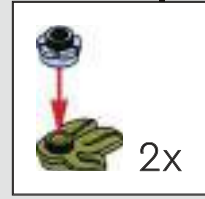
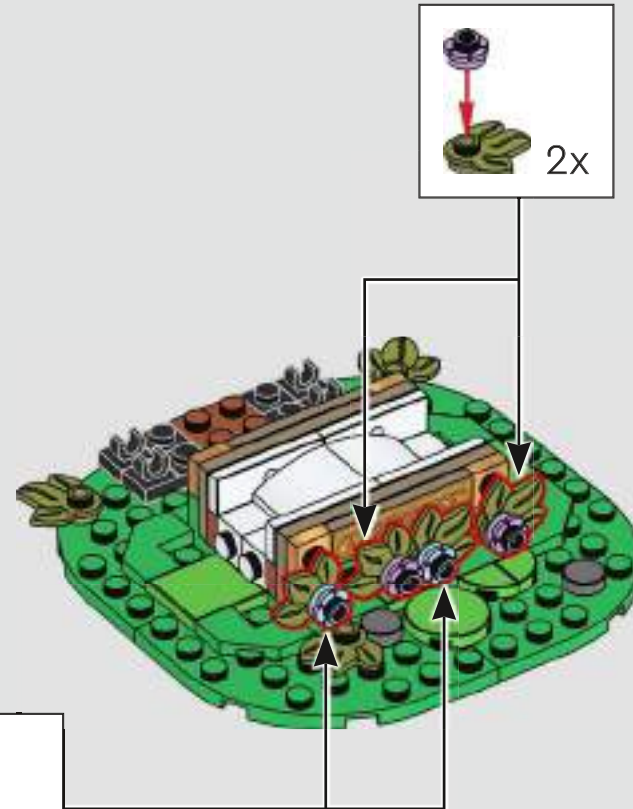

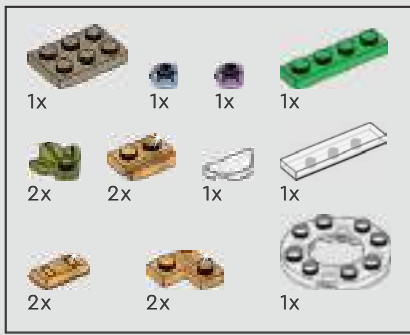

16

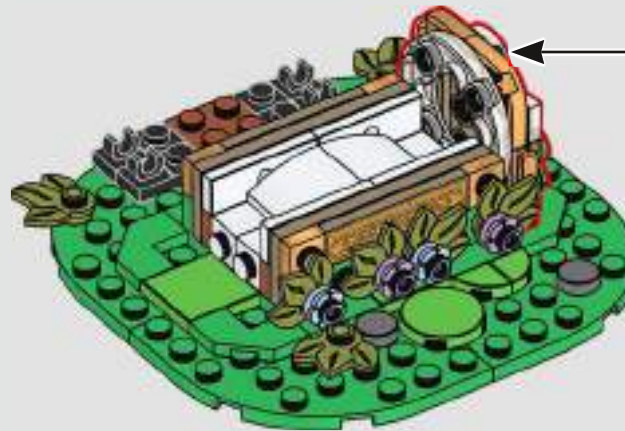
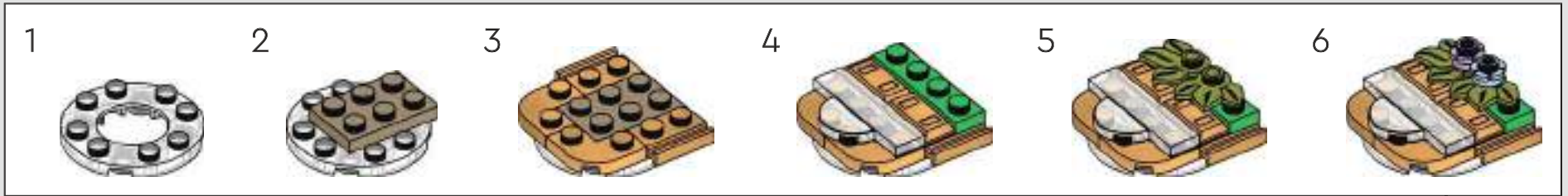



17

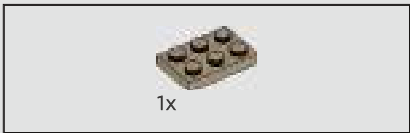

18

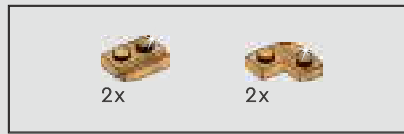

19

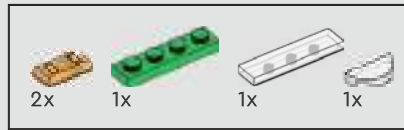

20





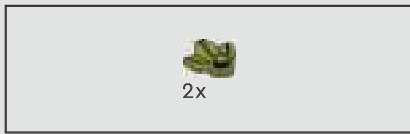

21

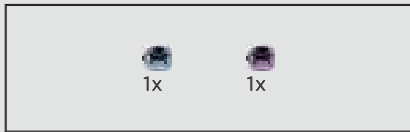

22

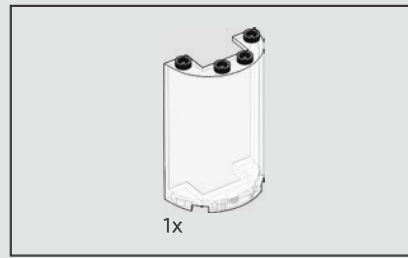

23

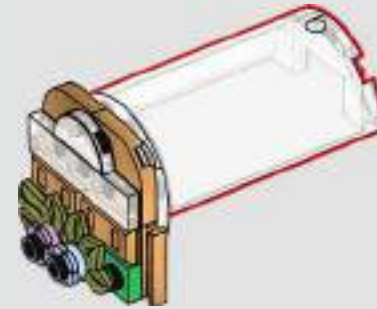

24



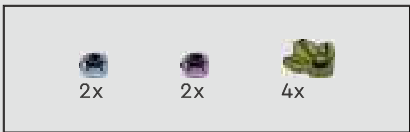

25

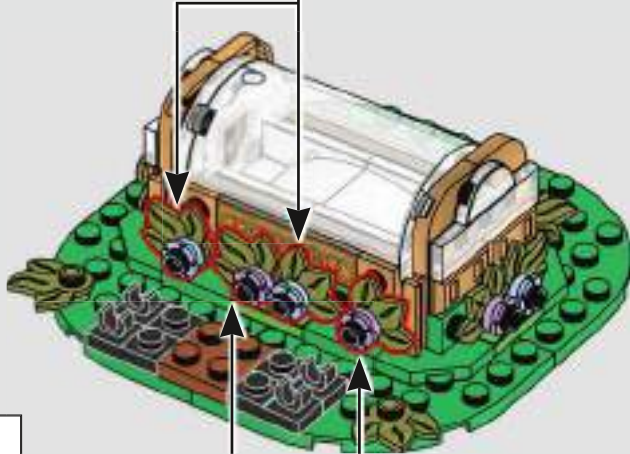

26

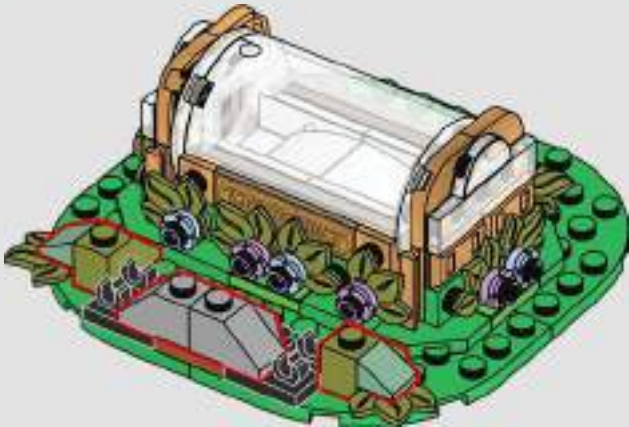



27

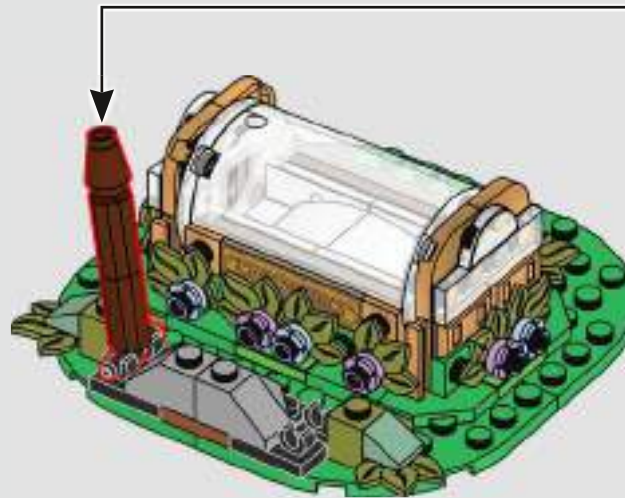
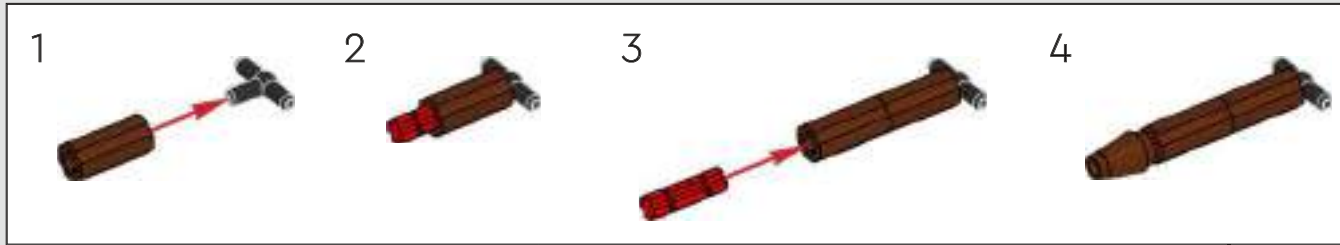



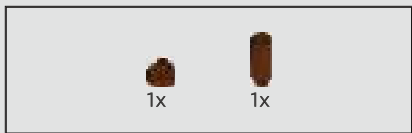

28

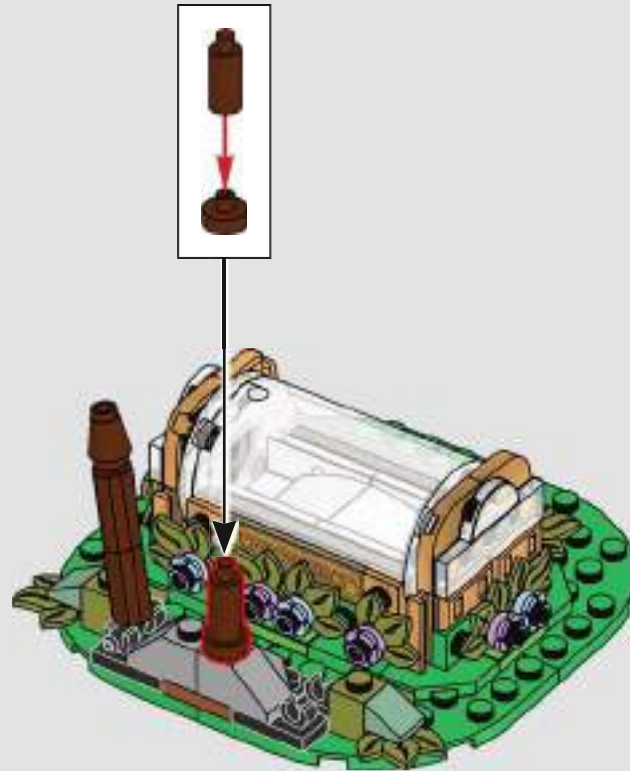



29

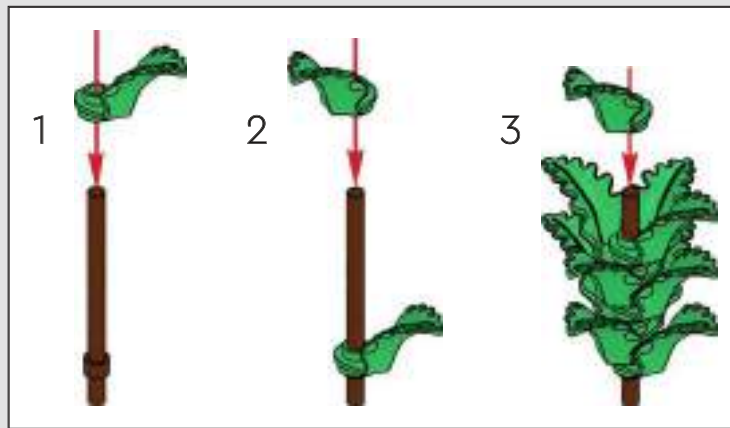



10x

30

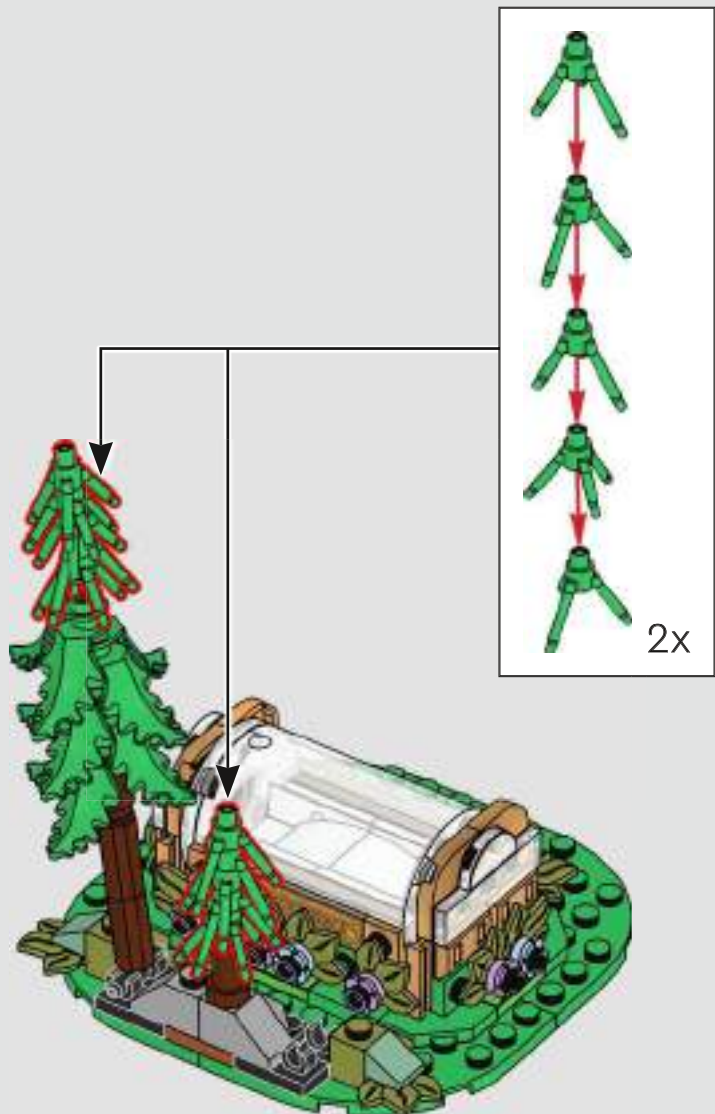



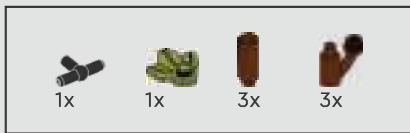

31

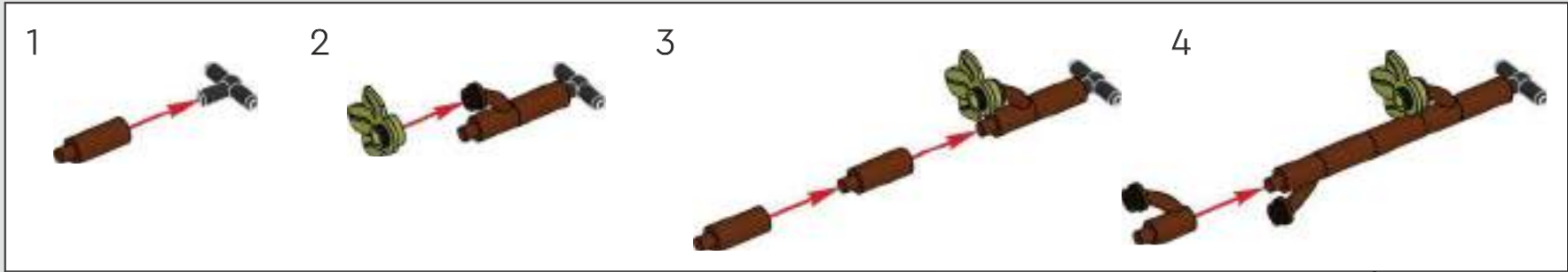



32

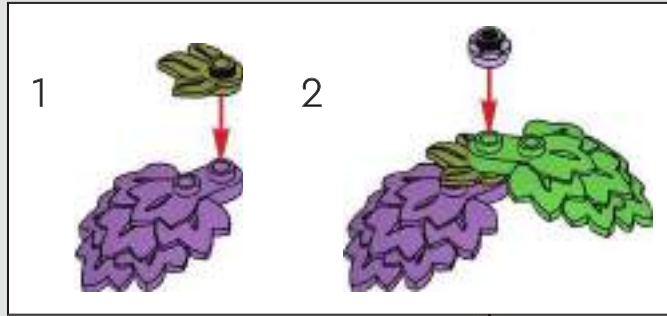



33

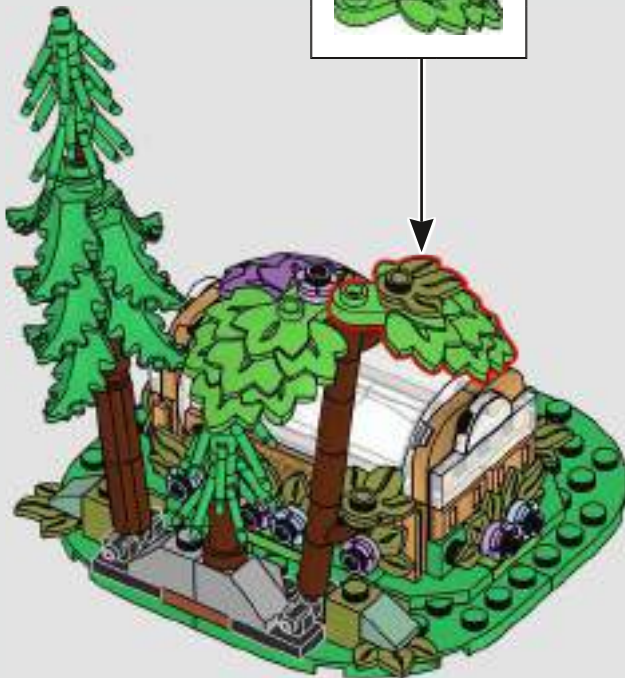

34

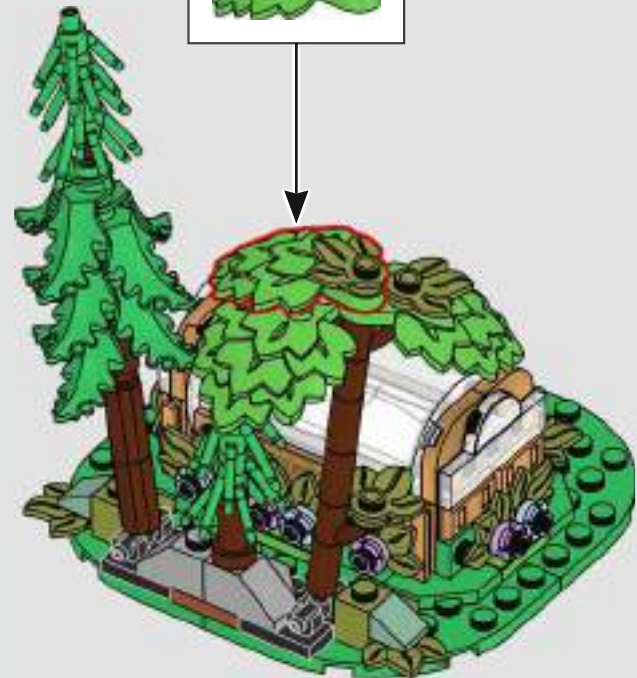







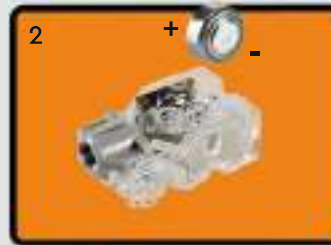

1:1  
2x LR 41 1.5V



**EN****Important information about batteries**

Never use different types of batteries together, or a combination of old and new batteries. Always remove the batteries if the product is not to be used for a long time or if the batteries have run down. Never use damaged batteries. Only use alkaline type batteries. Insert the batteries so that the poles are correctly positioned. Never attempt to recharge non-rechargeable batteries. Never short-circuit the battery holder.

**DE****Wichtige Informationen zu Batterien**

Benutzen Sie niemals unterschiedliche Arten von Batterien oder alte und neue gleichzeitig. Nehmen Sie stets die Batterien heraus, wenn mit dem Modell längere Zeit nicht gespielt wird oder wenn die Batterien leer sind. Verwenden Sie niemals beschädigte Batterien. Verwenden Sie ausschließlich Alkali-Batterien. Achten Sie beim Einsetzen der Batterien auf die richtige Polung. Versuchen Sie unter keinen Umständen, „normale“ Batterien wieder aufzuladen. Schließen Sie das Batteriefach niemals kurz.

**FR****Informations importantes concernant les piles**

Ne jamais utiliser un mélange de différents types de piles, ou de piles neuves et de piles anciennes ou déjà utilisées. Toujours retirer les piles si le produit n'est pas utilisé durant une période prolongée ou si les piles sont vides. Ne jamais utiliser de piles endommagées. N'utiliser que des piles alcalines. En insérant les piles, respecter scrupuleusement le sens d'orientation des pôles (+/-). Ne jamais essayer de recharger des piles non rechargeables. Ne jamais court-circuiter le compartiment des piles.

**IT****Importanti informazioni sulle batterie**

Non usare mai contemporaneamente batterie di tipo diverso o batterie nuove e usate insieme. Rimuovere sempre le batterie qualora il prodotto non venga utilizzato per periodi prolungati, oppure se le batterie sono esauste. Non utilizzare mai batterie danneggiate. Utilizzare solo batterie di tipo alcalino. Inserire le batterie avendo cura che la loro polarità sia corretta. Non tentare mai di ricaricare batterie non ricaricabili. Non cortocircuitare mai il portabatterie.

**NL****Belangrijke informatie over batterijen**

Gebruik nooit verschillende soorten of een combinatie van oude en nieuwe batterijen tegelijkertijd. Verwijder de batterijen altijd als je het product lange tijd niet wilt gebruiken of als batterijen leeg zijn. Gebruik nooit beschadigde batterijen. Gebruik alleen alkalinebatterijen. Plaats de batterijen met de polen in de juiste richting. Probeer nooit niet-oplaadbare batterijen opnieuw op te laden. Laat de batterijhouder nooit kortsluiten.

**ES****Información importante acerca de las pilas**

No use pilas de diferentes tipos ni pilas nuevas y antiguas para alimentar el producto. Extraiga las pilas del producto si este va a permanecer sin uso durante un período prolongado de tiempo o aquellas se han agotado. No use pilas dañadas. Use solo pilas alcalinas. Inserte las pilas de modo que los polos queden situados en las posiciones correctas. No trate de cargar pilas no recargables. No cortocircuite el compartimento de las pilas.

**DA****Vigtige oplysninger om batterier**

Brug aldrig forskellige batterityper sammen eller en kombination af gamle og nye batterier. Fjern altid batterierne, hvis produktet ikke skal bruges i lang tid, eller hvis batterierne er flade. Brug aldrig beskadigede batterier. Brug kun alkaliske batterier. Sæt batterierne i, så polerne vender den rigtige vej. Forsøg aldrig at oplade ikke-genopladelige batterier. Kortslut aldrig batteriholderen.

**IS****Mikilvægar upplýsingar um rafhlöður**

Aldrei skal nota mismunandi gerðir rafhlaðna samtímis, né nýjar og eldri rafhlöður samtímis. Ef ekki á að nota tækið í lengri tíma eða ef rafhlöðurnar eru orðnar tómar skal fjarlægja rafhlöðurnar. Aldrei skal nota rafhlöður sem hafa skemmt. Eingöngu má nota alkaline-rafhlöður. Setja skal rafhlöðurnar í þannig að plús- og mínusskaut þeirra snúi rétt. Aldrei skal reyna að endurhlaða rafhlöður sem ekki eru endurhlaðanlegar. Aldrei ætti að valda skammhlaupi í rafhlöðuhólfinu.

**FI****Tärkeää tietoa paristoista**

Älä koskaan käytä erityyppisiä paristoja yhdessä. Älä myöskään käytä samassa laitteessa sekä vanhoja että uusia paristoja. Poista paristot tuotteesta aina, kun se on pitemmän aikaa käyttämättä, tai kun paristot ovat tyhjentyneet. Älä koskaan käytä viallisia paristoja. Käytä vain alkaliparistoja. Aseta paristot siten, että navat osoittavat oikeaan suuntaan. Älä koskaan aiheuta oikosulkua pariston kosketinten välillä.

**SV****Viktig information om batterier**

Använd aldrig olika sorters batterier samtidigt, och inte heller en kombination av gamla och nya batterier. Ta alltid ur batterierna om produkten inte ska användas under en längre tid eller om batterierna är slut. Använd aldrig skadade batterier. Använd endast alkaliska batterier. Sätt i batterierna så att polerna hamnar i rätt läge. Försök aldrig ladda icke-laddningsbara batterier. Kortslut aldrig batteriutrymmets kontaktytor.

NO

### Viktig informasjon om batterier

Bruk aldri ulike typer batterier sammen og heller aldri gamle og nye batterier sammen. Ta alltid ut batteriene hvis produktet ikke skal brukes på lang tid, eller hvis batteriene er brukt opp. Bruk aldri skadde batterier. Bruk bare alkaliske batterier. Sett inn batteriene med polene vendt riktig vei. Forsøk aldri å lade opp ikke-oppladbare batterier. Kortslett aldri batteriholderen.

PT

### Informação importante sobre as pilhas

Nunca use diferentes tipos de pilhas em simultâneo, ou uma combinação de pilhas usadas e novas. Retire sempre as pilhas se o produto não for usado durante muito tempo ou se as pilhas já não tiverem carga. Nunca use pilhas danificadas. Use apenas pilhas alcalinas. Insira as pilhas de forma a que os polos fiquem corretamente posicionados. Nunca tente recarregar pilhas não recarregáveis. Nunca deixe o compartimento das pilhas entrar em curto-circuito.

EL

### Σημαντικές πληροφορίες για τις μπαταρίες

Μην χρησιμοποιείτε ποτέ διαφορετικού τύπου μπαταριών μαζί και μην συνδυάζετε παλιές και καινούργιες μπαταρίες. Αφαιρείτε πάντα τις μπαταρίες αν δεν σκοπεύετε να χρησιμοποιήσετε το προϊόν για αρκετό καιρό ή αν οι μπαταρίες έχουν αδειάσει. Ποτέ μην χρησιμοποιείτε μπαταρίες που έχουν φθορές. Χρησιμοποιείτε μόνο αλκαλικές μπαταρίες. Τοποθετήστε τις μπαταρίες με τους πόλους στη σωστή θέση. Μην επιχειρήσετε ποτέ να επαναφορτίσετε μη επαναφορτιζόμενες μπαταρίες. Ποτέ μην βραχυκυκλώνετε τη θήκη των μπαταριών.

JA

### 電池取扱に関する重要事項

異なるタイプの電池や古い電池を混ぜて使用しないでください。商品を長時間使用しないときや電池が切れたときは、電池を必ず取り外してください。不具合のある電池は絶対に使用しないでください。アルカリタイプの電池のみを使用してください。電極を確認して電池を正しい向きに入れてください。充電式ではない電池は絶対に充電しないでください。電池ホルダをショートさせないでください。

ZH

### 電池使用注意事項

请勿同时使用不同类型的电池，或把新旧程度不同的电池混合使用。如果产品将有很长时间不会使用，或者电池已经没电，请注意取出电池。切勿使用已破损的电池。仅可使用碱性电池。装入电池时请注意正负极。请勿尝试给非充电电池充电。切勿对电池仓进行短路连接。

KO

### 배터리 사용 시 주의사항

다른 종류의 배터리를 함께 사용하거나, 새 전지와 오래된 전지를 혼용하지 마세요. 배터리가 방전되었거나 장기간 제품을 작동하지 않을 때에는 반드시 배터리를 분리하세요. 파손된 배터리는 사용하지 마세요. 알칼라인 타입의 배터리만을 사용하세요. 양극과 음극의 위치를 잘 맞춰서 넣으세요. 일반 배터리는 충전해서 사용할 수 없습니다. 배터리 홀더의 접촉부에 배터리를 정확히 끼워서 사용하세요.

RU

### Необходимая информация об элементах питания

Ни в коем случае не используйте одновременно элементы питания различных типов, а также элементы питания с разным сроком годности. В обязательном порядке вынимайте элементы питания из терминалов в случае, если вы не пользуетесь прибором в течение долгого времени, либо в случае, если в элементах питания закончился заряд. Ни в коем случае не используйте поврежденные элементы питания. Используйте только элементы питания щелочного типа. Установите элементы питания, соблюдая указанную полярность. Ни в коем случае не пытайтесь подзаряжать непerezаряжаемые элементы питания. Ни в коем случае не пытайтесь замкнуть полюса в устройстве для элементов питания.

PL

### Ważne informacje dotyczące baterii

Nigdy nie należy stosować razem różnych rodzajów baterii ani stosować równocześnie starych i nowych baterii. Jeżeli produkt nie jest używany przez dłuższy czas lub jeżeli baterie się wyczerpały, należy wyjąć baterie. Nigdy nie należy stosować uszkodzonych baterii. Należy używać wyłącznie baterii alkalicznych. Przy wkładaniu baterii należy zwrócić uwagę na właściwe położenie biegunów. Nigdy nie należy próbować ładowania baterii jednorazowych. Nigdy nie należy doprowadzać do zwarcia w gnieździe baterii.

CZ

### Důležitá informace o bateriích

Nikdy nepoužívejte najednou různé typy baterií nebo kombinaci starých a nových baterií. Nebude-li se výrobek delší dobu používat nebo jsou-li baterie vybité, vždy je vyjměte z výrobku. Nikdy nepoužívejte poškozené baterie. Používejte pouze alkalické baterie. Baterie instalujte se správnou orientací pólů. Nikdy se nesazte nabíjet baterie, které nejsou nabíjitelné. Nikdy nezkratujte kontakty v prostoru pro baterie.

## SK

### **Dôležitá informácia o batériách**

Nikdy nepoužívajte naraz odlišné typy batérií ani nekombinujte staré batérie s novými. Batérie vždy vyberte, ak sa výrobok nebude dlhšie používať, alebo ak sa batérie vybili. Nikdy nepoužívajte poškodené batérie. Používajte iba alkalické batérie. Batérie vkladajte so správnou orientáciou pólov. Nikdy sa nesnažte nabíjať batérie, ktoré nie sú nabíjateľné. Nikdy neskratujte kontakty v priestore pre batérie.

## HU

### **Fontos tudnivalók az elemekről**

Soha ne használjon különböző típusú elemeket, illetve ne használjon vegyesen új és használt elemeket. Mindig távolítsa el az elemeket, ha a készüléket előre láthatóan hosszabb ideig nem fogják használni, vagy ha az elemek lemerültek. Soha ne használjon megrongálódott elemeket. Csak alkáli elemeket használjon! Az elemeket helyesen helyezze be, a polaritásuknak megfelelően. Soha ne próbálja meg feltölteni a nem tölthető elemeket. Soha ne hozzon létre rövidzárlatot az elemtartó kivezetésein.

## UA

### **Необхідна інформація про батареїки**

Ніколи не використовуйте одночасно батареїки різних типів або батареїки з різним терміном придатності. Обов'язково вилучайте батареїки з приладу, якщо довго не користуетесь ним, або якщо в батареїках уже скінчився заряд. Ніколи не використовуйте пошкоджені батареїки. Використовуйте лише лужні батареїки. Вставляйте батареїки, враховуючи задану полярність. У будь-якому випадку не намагайтеся підзарядити батареїки, що не підлягають підзарядці. У будь-якому випадку не намагайтеся зробити коротке замикання в приладі для батарей.

## HR

### **Važne obavijesti o bateriji**

Nikada nemoj koristiti različite vrste baterija zajedno, isto tako ni kombinaciju starih i novih baterija. Uvijek izvadi baterije ako dugo nećeš koristiti proizvod ili ako su one potrošene. Nikada nemoj koristiti oštećene baterije. Upotrebljavajte samo alkalne baterije. Umetni baterije pazeći da dobro okreneš polove. Nikada ne pokušavaj puniti baterije koje nisu predviđene za punjenje. Nikada ne izazivaj kratki spoj u držaču baterija.

## SR

### **Важне информације о батеријама**

Никада не користите различите типове батерија заједно нити комбинацију старих и нових батерија. Увек извадите батерије уколико производ нећете дуже време користити или уколико су батерије празне. Никада не користите оштећене батерије. Користите само алкалне батерије. Ставите батерије тако да су полови правилно позиционирани. Никада не покушавајте да пуните батерије које не могу да се пуне. Никада не изазивајте кратак спој у кућишту за батерије.

## MK

### **Важни информации за батериите**

Никогаш не користете различни типови батери заедно или комбинација од стари и нови батери. Секогаш отстранувајте ги батериите доколку не го користите производот подолго време или доколку се потрошиле. Никогаш не користете оштетени батери. Користете само алкални батери. Вметнете ги батериите така што точно ќе ги наместите половите. Никогаш не обидувајте се да ги полните батериите за еднократна употреба. Никогаш не предизвикувајте краток спој на држачот за батери.

## SL

### **Pomembne informacije o baterijah**

Nikoli ne uporabljajte skupaj različnih baterij ali kombinacije starih in novih baterij. Vedno odstranite baterije, če izdelka dlje časa ne boste uporabljali ali če so iztrošene. Nikoli ne uporabljajte poškodovanih baterij. Uporabljajte le alkalne baterije. Baterije vstavite tako, da so njihovi polji pravilno obrnjeni. Nikoli ne poskušajte polniti baterij, ki niso akumulatorske. Pazite, da ležišč za baterije ne boste spravili v kratek stik.

## RO

### **Informații importante despre baterii**

Nu folosiți niciodată împreună tipuri diferite de baterii, sau o combinație de baterii vechi și noi. Îndepărtați întotdeauna bateriile dacă produsul nu este folosit timp îndelungat sau dacă bateriile s-au epuizat. Nu folosiți niciodată baterii deteriorate. Utilizați numai baterii de tip alcalin. Introduceți bateriile astfel ca polii să fie poziționați corect. Nu încercați niciodată să reîncărcați baterii nereîncărcabile. Nu scurtcircuitați niciodată suportul bateriei.



## BG

### Важна информация за батериите

Никога не използвайте едновременно различни типове батерии или комбинация от стари и нови батерии. Винаги изваждайте батериите, ако изделието няма да се използва продължително време или ако батериите са се изтощили. Никога не използвайте повредени батерии. Използвайте само алкални батерии. Поставайте батериите така, че полюсите да са разположени правилно. Никога не опитвайте да зареждате батерии, които не са акумулаторни. Никога не свързвайте на късо контактите на отделението за батериите.

## LV

### Svarīga informācija par baterijām

Nekad vienlaikus nelietojiet dažādu tipu, kā arī vecas un jaunas baterijas. Vienmēr izņemiet baterijas, ja tās ir izlādējušās vai ja produkts ilgāku laiku netiek lietots. Nekad nelietojiet bojātas baterijas. Izmantojiet tikai sārma tipa baterijas. Ievietojot baterijas, ievērojiet pareizu polaritāti. Nekad nemēģiniet uzlādēt baterijas, kas nav uzlādējamās. Nepieļaujiet issavienojumu bateriju nodalījumā.

## ET

### Oluline teave patareide kohta

Ära kunagi kasuta koos erinevat tüüpi patareisid, samuti vanu ja uusi patareisid. Kui mänguasja ei kasutata pika aja jooksul, võta patarei sellest välja. Ära kunagi kasuta kahjustatud patareisid. Kasuta ainult leelispatareisid. Pane patareid mänguasja sisse nii, et pluss- ja miinusklemmi asend oleks õige. Ära kunagi proovi akulaadijaga laadida tavalisi patareisid. Patareipesa klemmide vahel ei tohi tekkida lühist.

## LT

### Svarbi informacija apie elementus

Vienu metu nenaudokite skirtingų elementų, taip pat su naujais elementais nenaudokite senų. Jei nenaudosite gaminio ilgesnį laiką arba jei elementai išseko, visuomet išimkite juos iš gaminio. Niekada nenaudokite pažeistų elementų. Naudokite tik šarminius elementus. Elementus dėkite atsižvelgdami į jų poliškumą. Niekada nebandykite įkrauti vienkartinį elementų. Saugokitės, kad elementų įdėkle nesukeltumėte trumpojo jungimo.

## TR

### Piller hakkında önemli bilgiler

Hiçbir zaman farklı tipte pilleri ya da eski pillerle yeni pilleri bir arada kullanmayın. Ürün uzun süre kullanılmayacaksa ya da piller bitmişse, pilleri ürünün içinden çıkarın. Hiçbir zaman zedelenmiş piller kullanmayın. Sadece alkaalin piller kullanın. Pilleri kutupları doğru konumda olacak şekilde yerleştirin. Hiçbir zaman, şarj edilebilir olmayan pilleri şarj etmeye çalışmayın. Hiçbir zaman pil kutusuna kısa devre yaptırmayın.

## AR

### معلومات مهمة عن البطاريات

يحظر استخدام أنواع مختلفة من البطاريات معا أو مزيج من البطاريات القديمة و الجديدة. احرص دائما على نزع البطاريات في حال عدم استخدام المنتج لفترة طويلة او إذا نفذت طاقة البطاريات. تجنب استخدام البطاريات التالفة. لا تستخدم إلا البطاريات القلوية فقط. قم بتكيب البطاريات بحيث تكون الأقطاب في موضعها الصحيح. يحظر إعادة شحن البطاريات غير القابلة لإعادة الشحن. تجنب إحداث دائرة قصر في حامل البطارية.

## ID

### Informasi penting tentang baterai

Jangan gunakan baterai yang jenisnya berlainan, atau mencampur baterai lama dan baterai baru. Lepas baterai jika produk tidak akan digunakan untuk waktu lama atau jika baterai sudah lemah. Jangan gunakan baterai yang rusak. Gunakan hanya baterai alkali. Masukkan baterai dengan posisi kutub yang tepat. Jangan pernah coba mengisi ulang baterai biasa. Jangan pernah membuat arus pendek pada dudukan baterai.

## MS

### Maklumat penting tentang bateri

Jangan guna jenis bateri yang berbeza bersama-sama, atau gabungan bateri baharu dan lama. Tanggalkan bateri jika produk tidak akan digunakan untuk tempoh masa yang lama atau jika bateri telah kehabisan kuasa. Jangan guna bateri yang rosak. Guna bateri jenis alkali sahaja. Selitkan bateri supaya paksi berada pada kedudukan yang betul. Jangan cuba untuk mengecas semula bateri yang tidak boleh dicaskan semula. Jangan pintas litar pemegang bateri.



EN  
WARNING: This product contains a Button or Coin Cell Battery. A swallowed Button or Coin Cell battery can cause internal chemical burns in as little as two hours and lead to death. Dispose of used batteries immediately. Keep new and used batteries away from children. If you think batteries might have been swallowed or placed inside any part of the body, seek immediate medical attention.

DE  
ACHTUNG: Dieses Produkt enthält eine Knopfzellenbatterie. Eine verschluckte Knopfzellenbatterie kann innere chemische Verbrennungen verursachen und in weniger als zwei Stunden zum Tod führen. Entsorge umgehend gebrauchte Batterien. Halte neue und gebrauchte Batterien von Kindern fern. Wenn du glaubst, dass Batterien verschluckt wurden oder sich in einem Körperteil befinden, hole umgehend medizinische Hilfe.

FR  
AVERTISSEMENT : Ce produit contient une pile bouton. L'ingestion d'une pile bouton peut provoquer des brûlures chimiques internes en seulement deux heures et provoquer la mort. Jeter immédiatement les piles usagées. Conserver les piles neuves et usagées hors de portée des enfants. Si vous suspectez l'ingestion d'une pile ou sa présence où que ce soit à l'intérieur du corps, consultez immédiatement un médecin.

IT  
ATTENZIONE: questo prodotto contiene una batteria a bottone. Se inghiottita, una batteria a bottone può causare ustioni chimiche interne in sole due ore, con possibile morte. Smaltire immediatamente le batterie usate. Tenere le batterie nuove e usate lontano dai bambini. Se si pensa che una batteria sia stata inghiottita o inserita in una parte del corpo, rivolgersi immediatamente a un medico.

NL  
WAARSCHUWING: dit product bevat een knoopcelbatterij. Als een knoopcelbatterij wordt ingeslikt, kan deze binnen twee uur chemische brandwonden veroorzaken in het lichaam. Het inslikken van een dergelijke batterij kan zelfs leiden tot overlijden. Gooi gebruikte batterijen onmiddellijk weg. Bewaar nieuwe en gebruikte batterijen buiten bereik van kinderen. Als je denkt dat een kind batterijen heeft ingeslikt of ze in een lichaamsopening heeft gestopt, raadpleeg je direct een arts.

ES  
ADVERTENCIA: Este producto contiene una pila de botón. Ingerir una pila de botón puede dar lugar a quemaduras químicas internas en tan sólo dos horas y provocar la muerte. Las pilas usadas deben desecharse inmediatamente. Mantenga las pilas nuevas y usadas fuera del alcance de los niños. Si sospecha de la ingestión o la introducción de pilas en cualquier parte del cuerpo, busque atención médica inmediatamente.

DA  
ADVARSEL: Dette produkt indeholder et knap- eller møntcellebatteri. Hvis et knap- eller møntcellebatteri sluges, kan det forårsage indvendige ætsninger på blot to timer og medføre døden. Bortskaf brugte batterier omgående. Hold både nye og brugte batterier uden for børns rækkevidde. Hvis du har mistanke om, at batterierne kan være blevet slugt eller kommet ind i nogen del af kroppen, skal du omgående søge lægehjælp.

IS  
VIÐVÖRUN: Þessi vara inniheldur hnapparafhlöðu eða flata rafhlöðu. Ef hnapparafhlaða eða flöt rafhlaða er gleypt getur hún valdið innvortis efnabruna á innan við tveimur klukkustundum og leitt til dauða. Fargaðu notuðum rafhlöðum tafarlaust. Geymdu nýjar og notaðar rafhlöður þar sem börn ná ekki til. Ef þú telur að rafhlöður hafi verið gleyptar eða á annan hátt komist inn í einhvern hluta líkamans skaltu tafarlaust leita læknaástoðar.

FI  
VAROITUS: Tämä tuote sisältää pienen tai isokokaisen nappipariston. Nieltynä pieni tai isokokoinen nappiparisto voi aiheuttaa sisäisiä kemiallisia palovammoja jo kahden tunnin kuluessa ja johtaa kuolemaan. Käytetyt paristot on toimitettava heti keräyspisteeseen. Pidä uudet ja käytetyt paristot poissa lasten ulottuvilta. Jos epäilet jonkun nielaisseen pariston tai laittaneensa pariston kehoonsa, vie hänet välittömästi lääkäriin.

SV  
VARNING: Denna produkt innehåller ett knapp- eller myntcells batteri. Förtäring av ett knapp- eller myntcells batteri kan orsaka inre kemiska brännskador på så kort tid som två timmar och leda till döden. Kasserat förbrukade batterier omedelbart. Förvara nya och använda batterier utom räckhåll för barn. Om du tror att batterierna kan ha svalts eller placerats inuti någon del av kroppen, sök omedelbart läkarvård.

NO  
ADVARSEL: Dette produktet inneholder et knapp- eller myntcellebatteri. Ved svelging kan knapp- eller myntcellebatterier gi kjemisk brannskade innvendig på bare to timer og føre til død. Brukte batterier skal avhendes øyeblikkelig. Nye og brukte batterier skal oppbevares utilgjengelig for barn. Hvis du tror at batterier har blitt svelget eller puttet inn andre steder i kroppen, må du kontakte lege øyeblikkelig.



PT

AVISO: Este produto contém uma pilha tipo botão ou moeda. Uma pilha tipo botão ou moeda que tenha sido engolidas pode provocar queimaduras químicas internas em menos de duas horas e levar à morte. Elimine as pilhas usadas imediatamente. Mantenha as pilhas novas e usadas fora do alcance das crianças. Se pensa que as pilhas podem ter sido engolidas ou colocadas no interior de alguma parte do corpo, procure de imediato assistência médica.

EL

ΠΡΟΕΙΔΟΠΟΙΗΣΗ: Αυτό το προϊόν περιέχει μία Στρογγυλή Μπαταρία Μεγέθους Κουμπιού ή Κέρματος. Η κατάποση μιας Στρογγυλής Μπαταρίας Μεγέθους Κουμπιού ή Κέρματος μπορεί να προκαλέσει εσωτερικά χημικά εγκαύματα σε μόλις δύο ώρες και να οδηγήσει σε θάνατο. Πετάξτε αμέσως τις χρησιμοποιημένες μπαταρίες. Κρατήστε τις καινούργιες και τις χρησιμοποιημένες μπαταρίες μακριά από τα παιδιά. Εάν νομίζετε ότι κάποια μπαταρία έχει καταποθεί ή τοποθετηθεί εντός οποιουδήποτε μέρους του σώματος, ζητήστε αμέσως ιατρική βοήθεια.

JA

警告：本製品には、ボタン型またはコイン型の電池が使用されています。  
ボタン型またはコイン型電池は誤飲すると2時間以内に体内で化学火傷を起こし、死に至る恐れがあります。使用済みの電池は直ちに廃棄してください。新しい電池および使用済み電池は、どちらもお子様の手の届かないところに保管してください。電池を誤飲した恐れがある、または電池が身体のとこかに入った恐れがある場合は、直ちに医師の診察を受けてください。

ZH

警告：本品内含一颗纽扣电池。  
吞咽的纽扣电池仅在两小时内就会引起体内化学灼伤并导致死亡！请立即处理使用过的电池。请将新、旧电池放置到儿童接触不到的地方。如果电池被不慎吞下，或被置入身体的任何一个部位，请立即就医！

KO

경고: 이 제품에는 버튼 또는 코인 셀 배터리가 포함되어 있습니다. 코인 셀 배터리를 삼킬 경우, 빠르면 2시간 이내에 체내에서 화학적 화상이 일어나고 심하면 사망에 이를 수 있습니다. 다 쓴 배터리는 즉시 폐기하십시오. 배터리를 어린이의 손에 닿지 않는 곳에 보관하십시오. 배터리를 삼켰거나 신체 어느 부위에든 들어간 것으로 판단될 경우, 즉각 의사의 도움을 구하십시오.

RU

ПРЕДОСТЕРЕЖЕНИЕ. Эта игрушка работает от батареек таблеточного или кнопочного типа. Проглатывание батареек таблеточного или кнопочного типа может (в течение двух часов) вызвать химические ожоги внутренних органов и привести к летальному исходу. Своевременно утилизируйте использованные батарейки. Храните новые и использованные батарейки в местах, недоступных для детей. Если у вас есть основания полагать, что ребенок проглотил батарейку или она попала внутрь какой-либо части его тела, немедленно обратитесь за медицинской помощью.

PL

OSTRZEŻENIE: w tym produkcie znajduje się płaska okrągła bateria.

Połknięcie takiej baterii może spowodować chemiczne oparzenia wewnętrzne już po dwóch godzinach, a także doprowadzić do śmierci. Gdy bateria się zużyje, należy ją natychmiast zutylizować. Nowe i używane baterie należy przechowywać z dala od dzieci. W przypadku stwierdzenia, że baterie mogły zostać połknięte lub inaczej trafić do organizmu, należy natychmiast poszukać pomocy lekarskiej.

CZ

VAROVÁNÍ: Tento výrobek obsahuje knoflíkovou nebo mincovou baterii.

Společnosti knoflíkové nebo mincové baterie může během pouhých 2 hodin způsobit vnitřní poleptání sliznice a v některých případech mít za následek smrt. Použité baterie ihned vyjměte a zlikvidujte. Nové i použité baterie uchovávejte mimo dosah dětí. V případě spolknutí či uviznutí baterie v některé části těla okamžitě vyhledejte lékařskou pomoc.

SK

UPOZORNENIE: Tento produkt obsahuje gombíkovú alebo mincovú batériu.

Prehltnutie gombíkovej alebo mincovej batérie môže spôsobiť vnútorné chemické popáleniny už do dvoch hodín a viesť k úmrtiu. Použité batérie ihneď vyhod'te. Nové aj použité batérie uchovávajte mimo dosahu detí. Ak si myslíte, že mohlo dôjsť k prehltnutiu batérie alebo sa batéria mohla dostať do vnútra ktorejkoľvek časti tela, okamžite vyhľadajte lekársku pomoc.

HU

FIGYELMEZTETÉS: Ez a termék gombelemet illetve lapos gombelemet tartalmaz!

A lenyelt gombelem vagy lapos gombelem akár két óra alatt is belső vegyi sérüléseket okozhat, ami halálhoz vezethet. Az elhasznált elemeket azonnal dobja ki! Az új és a használt elemeket ne adja gyermekek kezébe! Ha úgy gondolja, hogy valaki lenyelt egy elemet, vagy bekerült valakinek valamely testrészébe, akkor azonnal kérjen orvosi segítséget!

UA

ОБЕРЕЖНО. Продукт містить мініатюрну батарейку типу «таблетка».

Якщо проковтнути мініатюрну батарейку, вона може спричинити внутрішні хімічні опіки протягом двох годин і призвести до смерті. Негайно утилізуйте використані батарейки. Зберігайте нові та використані батарейки недоступними для дітей. Якщо вам здається, що дитина проковтнула батарейку чи вона опинилася в будь-якій частині тіла дитини, негайно зверніться до лікаря.

HR

UPOZORENJE: Ovaj proizvod sadrži gumbastu bateriju ili bateriju oblika kovanice.

Ako se gumbasta baterija ili baterija oblika kovanice proguta, za samo dva sata može uzrokovati unutarnje kemijske opекline i izazvati smrt. Iskorištene baterije odmah odložite u otpad. Čuvajte nove i stare baterije dalje od djece. Ako mislite da je baterija progutana ili je dospjela u bilo koji dijela tijela, odmah zatražite liječničku pomoć.





SR

**УПОЗОРЕЊЕ:** Овај производ садржи дугмасту батерију. Прогутана дугмаста батерија може да доведе до интерних хемијских опекотина већ за два сата и доводи до смрти. Одмах одложите искоришћене батерије у отпад. Чувајте нове и искоришћене батерије ван домаћаја деце. Ако мислите да је дошло до гутања батерија или стављања у било који део тела, одмах потражите помоћ лекара.

МК

**ПРЕДУПРЕДУВАЊЕ:** Овој производ садржи батерија тип копче или тип монета. Проголтувањето на батерија тип копче или тип монета може да предизвика внатрешно хемиско горење во рок од два часа и да доведе до смрт. Исфрлете ги веднаш искористените батерији. Држете ги новите и користените батерији подалеку од деца. Ако мислите дека е можно батериите да се проголтани или поставени во кој било дел на телото, веднаш побарајте медицинска помош.

SL

**ОПОЗОРИЛО:** Ta izdelek vsebuje gumbasto baterijo. Če oseba požre gumbasto baterijo, lahko to povzroči kemične opekline notranjih organov že v dveh urah po zaužitju. Tovrstne poškodbe lahko vodijo v smrt. Iztrošene baterije takoj zavrzite. Pazite, da nove ali iztrošene baterije ne bodo v dosegu otrok. Če menite, da je oseba zaužila baterijo ali si jo vstavila v kateri koli del telesa, takoj poiščite zdravniško pomoč.

RO

**AVERTIZARE:** Acest produs conține o baterie de tip pastilă. Înghițirea unei baterii de tip pastilă poate cauza arsuri chimice interne în doar două ore, ducând la deces. Debarasați-vă imediat de bateriile uzate. Nu lăsați bateriile noi și uzate la îndemâna copiilor. Dacă credeți că bateriile ar fi putut fi înghițite sau ar fi putut ajunge în interiorul oricărei părți a corpului, solicitați imediat asistență medicală.

BG

**ПРЕДУПРЕЖДЕНИЕ:** Този продукт съдържа батерия тип „копче“ или „монета“. При поглъщане батериите тип „копче“ или „монета“ могат да предизвикат вътрешни химически изгаряния в рамките на по-малко от два часа и да доведат до смърт. Незабавно изхвърляйте използваните батерији. Дръжете новите и стари батерији далек от деца. Ако смятате, че е възможно батериите да са били погълнати или да са попаднали където и да е вътре в тялото, потърсете незабавно медицинска помощ.

LV

**BRĪDINĀJUMS.** Šim produktam ir pogas jeb monētas tipa akumulators. Ja pogas jeb monētas tipa akumulators tiek norīts, tas jau divu stundu laikā var izraisīt iekšējus ķīmiskus apdegumus un izraisīt nāvi. Nekavējoties utilizējiet izlietotos akumulatorus. Jaunus un lietotus akumulatorus glabājiet bērniem nepieejamā vietā. Ja uzskatāt, ka akumulators varētu būt norīts vai ievietots kādā ķermeņa daļā, nekavējoties vērsieties pēc medicīniskās palīdzības.

ET

**HOIATUS!** See toode sisaldab nõõp- või müntpatareid. Alla neelatud nõõp- või müntpatareid võib tekitada sisemisi keemilisi põletusi kõigest kahe tunniga ning põhjustada surma. Kõrvaldage kasutatud patareid viivitamatult. Hoidke uusi ja kasutatud patareisid lastele kättesaamatus kohas. Kui arvate, et keegi on patareid alla neelanud või need on sattunud mõnda kehaosasse, pöörduge kohe arsti poole.

LT

**JSPĖJIMAS.** Šiame gaminyje yra sagos arba monetos formos baterija. Praryta sagos arba monetos formos baterija gali sukelti vidinius cheminius nudeginimus greičiau nei per dvi valandas ir gali ausiai sukelti mirtį. Panaudotas baterijas nedelsiant utilizuokite. Naujas ir panaudotas baterijas laikykite atokiau nuo vaikų. Jei manote, kad vaikas galėjo praryti arba įsprausti bateriją sau į kūną, nedelsdami kreipkitės medicininės pagalbos.

TR

**UYARI:** Bu ürün bir düğme pil içerir. Yutulmuş düğme pil, iki saat gibi kısa bir sürede iç kimyasal yanıklara neden olabilir ve ölüme yol açabilir. Kullanılmış pilleri derhal atın. Yeni ve kullanılmıř pilleri çocuklardan uzak tutun. Pillerin yutulmuş ya da vücudun başka bir yerine sokulmuş olabileceğini düşünürseniz derhal doktora başvurun.

AR

**تحذير:** يحتوي هذا المنتج على بطارية خلايا قرصية أو بطارية خلايا على شكل عملة. قد يؤدي ابتلاع بطارية خلايا قرصية أو بطارية خلايا على شكل عملة إلى حدوث حروق كيميائية داخلية خلال فترة قصيرة لا تتجاوز ساعتين وقد يؤدي إلى الوفاة. يرجى التخلص من البطاريات المستعملة على الفور. مع الاحتفاظ بالبطاريات الجديدة والمستعملة بعيداً عن متناول الأطفال. إذا كنت تعتقد أن البطاريات تم ابتلاعها أو إدخالها إلى أي جزء من أجزاء الجسم، فاطلب المساعدة الطبية على الفور.

ID

**PERINGATAN:** Produk ini berisi Baterai Sel Kancing. Baterai Sel Kancing yang tertelan dapat mengakibatkan luka bakar kimiawi dalam tubuh minimal setelah dua jam dan dapat mengakibatkan kematian. Segera buang baterai yang sudah tidak digunakan. Jauhkan baterai baru maupun bekas dari jangkauan anak-anak. Jika Anda curiga baterai telah tertelan atau masuk ke dalam tubuh, segeralah minta bantuan dokter.

MS

**AMARAN:** Produk ini mengandungi Bateri Sel Butang atau Syiling. Tertelan bateri Sel Butang atau Syiling boleh mengakibatkan lecuran kimia dalaman dalam tempoh sekurang-kurangnya dua jam dan menyebabkan kematian. Buang bateri terpakai dengan serta-merta. Jauhkan bateri baharu dan terpakai daripada kanak-kanak. Jika anda mendapati bateri mungkin telah ditelan atau termasuk ke dalam mana-mana bahagian badan, dapatkan rawatan perubatan dengan segera.



EN

Protect the environment by not disposing of this product with your household waste. Check with your local authority for recycling advice and facilities. Penalties may apply for improper disposal.

DE

Schützen Sie die Umwelt und entsorgen Sie dieses Produkt nicht mit Ihrem Hausmüll. Informationen zu Recycling-Möglichkeiten erhalten Sie bei den örtlichen Behörden. Bei unsachgemäßer Entsorgung können Strafen verhängt werden.

FR

Protégez l'environnement : ne jetez pas ce produit avec vos autres déchets ménagers. Contactez les autorités locales pour obtenir des informations sur le recyclage et connaître les points de collecte. Des sanctions peuvent être appliquées en cas d'élimination inappropriée.



IT

Proteggi l'ambiente! Non smaltire questo prodotto con i rifiuti domestici. Per consulenza sul riciclaggio dei rifiuti e le strutture di riciclaggio, rivolgersi alle proprie autorità locali. Uno smaltimento improprio può comportare sanzioni.

NL

Bescherm het milieu: gooi dit product niet samen met het andere huisvuil weg. Raadpleeg de plaatselijke instanties voor locaties van milieustations en advies over hergebruik. In geval van onjuiste verwijdering kunnen boetes worden opgelegd.

ES

Proteja el medio ambiente no deshaciéndose de este producto junto con sus residuos domésticos. Solicite asesoramiento e información sobre instalaciones de reciclaje a las autoridades locales. La eliminación inadecuada puede ser objeto de sanciones.

DA

Beskyt miljøet! Smid ikke dette produkt ud sammen med husholdningsaffaldet. Få vejledning om genbrug og genbrugsstationer hos din kommune. Ukorrekt bortskaftelse kan medføre bøde eller straf.

IS

Stuðlið að umhverfisvernd með því að farga þessari vöru ekki með heimilissorpi. Leitid upplýsinga um endurvinnslu- og förgunarstaði hjá yfirvöldum á hverjum stað. Viðurlögum kann að vera beitt ef förgun er ekki með réttum hætti.

FI

Tämä tuote on hävitettävä ympäristöstävällisesti ja erillään muusta talousjätteestä. Tietoja kierrätyksestä ja keräyspisteiden sijainnista saat paikkakuntasi teknisestä virastosta. Epäasianmukaisesta hävittämisestä saattaa aiheutua seuraamuksia.

SV

Skydda miljön genom att inte kasta denna produkt bland ditt hushållsavfall. Kontakta din kommun för frågor om återvinning och miljöstationer. Påföljder kan tillkomma för felaktig avyttring.

NO

Beskytt miljøet. Ikke kast dette produktet i husholdningsavfallet. Kontakt kommunen for veiledning om gjenbruk og miljøstasjoner. Feil avfallshåndtering kan være straffbart.

PT

Proteja o ambiente não eliminando este produto com o seu lixo doméstico. Consulte as autoridades locais para informação sobre reciclagem e sistemas de recolha. Podem ser aplicadas coimas por eliminação inadequada.

EL

Προστατέψτε το περιβάλλον. Μην πετάτε αυτό το προϊόν μαζί με τα συνηθισμένα οικιακά απορρίμματα. Επικοινωνήστε με τις τοπικές αρχές σχετικά με συμβουλές και εγκαταστάσεις ανακύκλωσης. Ενδέχεται να επιβάλλονται κυρώσεις για ακατάλληλη διάθεση απορριμμάτων.

JA

環境保護のため、本製品は家庭ごみとは別に処分してください。リサイクルに関する指示や施設については、お住まいの地方自治体にお問い合わせください。不適切な廃棄を行った場合、罰則が適用されることがあります。



#### ZH

注意保护环境, 请勿将本产品与生活垃圾一起丢弃处理。  
请咨询当地相关部门, 了解与回收相关的设施与建议。  
处理不当可能会导致处罚。

#### KO

환경 보호를 위해 이 제품을 생활폐기물과 함께 버리지 마십시오.  
재활용 방법 및 시설에 관한 사항은 현지 관계 당국에 문의하십시오. 부적절하게 폐기할  
경우 벌칙이 부과될 수 있습니다.

#### RU

Позаботьтесь об окружающей среде: не утилизируйте этот продукт  
вместе с бытовым мусором.  
Узнайте в органах местного самоуправления правила вторичной  
переработки и утилизации таких отходов.  
В случае ненадлежащей утилизации могут быть наложены штрафы.

#### PL

Aby chronić środowisko naturalne, nie należy wyrzucać tego produktu wraz z  
odpadkami z gospodarstwa domowego.  
W celu uzyskania wskazówek dotyczących recyklingu oraz adresów zakładów  
należy skontaktować się z lokalnym urzędem.  
Za nieprzestrzeganie zasad związanych z utylizacją odpadów grożą kary.

#### CZ

Nevyhazujte tento produkt do domácího odpadu, chráňte životní prostředí.  
Zjistěte si prosím u místních úřadů možnosti recyklace a dostupná zařízení.  
Nesprávná likvidace může být pokutována.

#### SK

Nevyhazujte tento produkt do domáceho odpadu, chráňte životné  
prostredie.  
Zistite si na miestnych úradoch možnosti recyklácie a dostupné zariadenia.  
Za nesprávnú likvidáciu môžu byť uložené sankcie.

#### HU

Környezetét óvja, ha ettől a terméktől nem a háztartási hulladékkal együtt  
vállik meg.  
Érdeklődjék a lakóhelyéhez közel eső hatóságnál az újrahásznosítás módjáról  
és lehetőségéről. A nem megfelelő hulladékelhelyezésért büntetés járhat.

#### UA

Допоможіть захистити довкілля: не утилізуйте цей виріб разом із  
побутовим сміттям.  
Вказівки з утилізації та відомості про пункти прийому з'ясуйте в місцевих  
компетентних органів. У разі неналежної утилізації можуть  
застосовуватися штрафи.

#### HR

Zaštítite okoliš tako da ovaj proizvod ne odložite u otpad zajedno s  
kućanskim otpadom.  
Od lokalnih vlasti zatražite savjet ili informacije o pogonima za recikliranje.  
Moguća je kazna za nepropisno zbrinjavanje.

#### SR

Zaštítite životnu sredinu tako što nećete da odlažete ovaj proizvod  
sa kućnim otpadom.  
Raspitajte se kod lokalnog nadležnog organa o načinu reciklaže i o  
sabitrom centru. U slučaju nepravilnog odlagaња u otpad, mogu biti  
izrecene kazne.

#### MK

Zaštítite ja okolinata tako što nema da se oslobodite od proizvodot  
so domashniot otpad.  
Konsultirajte se so lokalnite vlasti za da doznaete za sovetite i  
objektite za recikliraње. Vozmožno e da bidat primeneti kazni za  
nepravilno isfrplaње.

#### SL

Zaščitite okolje! Okolje varujte tako, da tega izdelka ne zavržete skupaj z  
gospodinjiskimi odpadki.  
Pri krajevni upravi preverite, kakšne možnosti in kateri obrati za recikliranje  
obstajajo v vaši okolici. Za nepravilno odlaganje odpadkov vas lahko doleti  
kazen.

#### RO

Protejați mediul înconjurător și nu vă debarasați de acest produs împreună  
cu deșeurile menajere.  
Consultați autoritățile locale pentru îndrumări și facilități de reciclare.  
Dezafectarea necorespunzătoare poate atrage sancțiuni.

#### BG

Zaštítite okolnata sreda i ne izhvǎrlyajte tozi produkt zaedno s  
bitovite si otpadyci.  
Svǎrжете се с местните власти относно съвети и съоръжения за  
рециклиране. Възможно е да има глоби за неправоно изхвърляне.

#### LV

Lai saudzētu vidi, neizmetiet šo izstrādājumu kopā ar sadzīves atkritumiem.  
Vērsieties vietējās varas iestādēs, lai noskaidrotu, kur un kā tas nododams  
pārstrādei. Par neatbilstošu likvidēšanu var tikt piemērots sods.





ET

Keskkonda saate kaitsta nii, et ei kõrvalda seda toodet koos olmejäätmetega.

Nõuandeid toote taaskasutusse võtmise ja ümbertöötlemispunktide kohta saate asjaomaselt kohalikult asutuselt.

Nõuetele mittevastav kasutuselt kõrvaldamine võib kaasa tuua trahvid.

LT

Saugokite aplinką: nemeskite šio produkto kartu su buitinėmis atliekomis.

Atsižvelkite į savo vietos valdžios rekomendacijas dėl pakartotinio panaudojimo ir sąlygas. Už netinkamą šalinimą gali būti taikomos baudos.

TR

Bu ürünü, evsel atıklarla birlikte atmayarak çevreyi koruyun.

Geri dönüşüm tavsiyeleri ve tesisler hakkında bilgi için yerel yönetimle iletişim kurun. Uygunsuz atılması durumunda cezalar uygulanabilir.

AR

احم البيئة بعدم التخلص من هذا المنتج مع المخلفات المنزلية.  
استشر السلطة المحلية لديك للحصول على نصح بخصوص إعادة تدوير المخلفات ومراقبه.  
قد يتم تطبيق عقوبات على التخلص غير السليم.

ID

Jagalah lingkungan dengan tidak membuang produk ini bersama sampah rumah tangga Anda.

Periksa peraturan pemerintah setempat tentang saran dan fasilitas daur ulang. Pembuangan yang tidak sesuai ketentuan dapat dikenakan denda.

MS

Lindungi alam sekitar dengan tidak melupuskan produk ini bersama sisa isi rumah anda.

Rujuk pihak berkuasa tempatan anda tentang nasihat dan kemudahan kitar semula. Penalti boleh dikenakan untuk pelupusan yang tidak wajar.

















EN Please retain the leaflet and packaging as they contain important information  
DE Broschüre und Verpackung bitte aufbewahren, sie enthalten wichtige Informationen  
FR Veuillez conserver le dépliant et l'emballage, car ils contiennent des informations importantes  
IT Conserva l'opuscolo e la confezione in quanto contengono informazioni importanti  
NL Bewaar a.u.b. de folder en verpakking: die bevatten belangrijke informatie  
ES Conserve el folleto y el embalaje; contienen información importante  
DA Gem hæftet og emballagen, da de indeholder vigtige oplysninger  
IS Geymið bæklinginn og umbúðirnar þar sem þau innihalda mikilvægar upplýsingar  
FI Säilytä esite ja pakkaus, koska ne sisältävät tärkeää tietoa  
SV Spara broschyren och förpackningen eftersom de innehåller viktig information  
NO Heftet og emballasjen inneholder viktig informasjon og skal beholdes  
PT Por favor guarde o folheto e a embalagem, pois contém informação importante  
EL Κρατήστε το φυλλάδιο και τη συσκευασία γιατί περιέχουν σημαντικές πληροφορίες  
JA 説明書とパッケージには重要な情報が含まれていますので保管しておいてください  
ZH 说明书和包装均包含重要信息, 请妥善保存  
KO 중요한 정보가 담겨 있으므로 리플릿과 포장을 보관해주세요  
RU Пожалуйста, сохраните эту брошюру и упаковку, поскольку они содержат важную информацию  
PL Prosimy zachować ulotkę i opakowanie, ponieważ zawierają one ważne informacje  
CZ Ponechte si prosím leták i obal, neboť obsahují důležité informace  
SK Ponechajte si prosím leták aj obal, pretože obsahujú dôležité informácie  
HU Kérjük, őrizze meg a szórólapot és a csomagolást, mert fontos tudnivalókat tartalmaznak  
UA Будь ласка, зберігайте вкладиш та упаковку, оскільки вони містять важливу інформацію







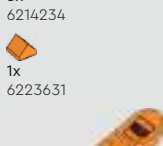









HR Spremite letak i ambalažu jer sadrže važne obavijesti  
SR Молимо да сачувате упутство и паковање јер се на њима налазе важне информације  
MK Чувајте ги брошурата и амбалажата бидејќи содржат важна информација  
SL Prosimo, da brošurico in embalažo shranite, saj vključujeta pomembne informacije  
RO Vă rugăm să păstrați prospectul și ambalajul întrucât conțin informații importante  
BG Запазете листовката и опаковката, тъй като съдържат важна информация  
LV Lūdzu, saglabājiet bukletu un iepakojumu, jo uz tā ir norādīta svarīga informācija  
ET Hoidke infoleht ja pakend alles, sest nendele on märgitud oluline teave  
LT Išsaugokite informacinį lapelį ir pakuotę, nes ant jų pateikiama svarbi informacija  
TR Önemli bilgiler içerdiği için broşürü ve ambalajı saklayın  
AR الرجاء الاحتفاظ بالنشرة والغلاف لاحتوائهما على معلومات هامة  
ID Harap simpan brosur dan kemasan ini karena berisi informasi penting  
MS Sila simpan risalah dan pembungkusan kerana ia mengandungi maklumat penting

















LEGO System A/S  
Aastvej 1  
DK-7190 Billund















2x 6186681	1x 6310183	24x 4159553	1x 4205107	6x 6213676	2x 4206482	3x 6104209	6x 6338221	5x 6143431	18x 6074892
3x 6168642	2x 6173116	2x 6232135	2x 6387150	1x 4113233	1x 6444727	1x 6390775	30x 6411022	2x 6228968	1x 6074893
2x 6253309	4x 6034044	3x 4125253	2x 6148262	3x 4112982	1x 6444735	3x 6196548	30x 6269971	1x 6384077	2x 6468066
1x 6177114	2x 6293665	2x 4516055	2x 6148262	3x 4112982	1x 6444735	2x 6196548	7x 6311453	1x 6266964	1x 6466026
6x 6258135	2x 6217875	3x 6360037	1x 6226564	1x 6106187	2x 6284577	2x 6297875	5x 6070506	1x 6466026	1x 6400293
4x 6235083	2x 6047220	1x 6286492	4x 6226565	1x 6106187	4x 6168644	1x 6057397	1x 6141590	2x 6188477	8x 4535928
1x 654101	1x 6261390	3x 4624086	2x 4124455	1x 6378358	1x 4504381	1x 6281919	6x 6352550	9x 4616027	13x 6253418
6x 6172366	4x 6223491	1x 6476341	4x 6055868	1x 4249019	1x 6310247	10x 6347310	5x 6457953	2x 6295081	11x 6219673
2x 6348055	3x 6478180	15x 4218749	9x 4162465	2x 4295313	1x 6315887	1x 6234806	2x 6406233	22x 4570877	15x 6426644
4x 6218841	1x 6323929	14x 6478176	6x 4121921	1x 4295313	4x 6443416	1x 6436038	22x 6275873	1x 6313129	15x 6426644
7x 6474222	1x 6444853	15x 6214334	1x 6484242	1x 6337734	2x 6273589	2x 6089119	27x 6182261	2x 6186009	1x 6310668
3x 6466031	1x 4529237	2x 6092587	1x 6484242	6x 307021	4x 6443416	2x 6089119	4x 6422433	7x 6396922	1x 6310668
1x 6461276	1x 4113917	17x 4113917	1x 6484242	6x 307021	2x 6273589	2x 6089119	7x 6294513	1x 6092602	1x 6310668
3x 6466029	1x 4117070	17x 4626200	1x 6484242	6x 307021	2x 6273589	2x 6089119	4x 6422433	7x 6396922	1x 6310668
2x 4224792	1x 6400380	17x 4626200	1x 6484242	6x 307021	2x 6273589	2x 6089119	7x 6294513	1x 6092602	1x 6310668
2x 4547489	1x 6400380	2x 6146221	1x 6484242	6x 307021	2x 6273589	2x 6089119	4x 6074890	15x 4615606	2x 6263971
3x 6093053	15x 4113915	10x 6069165	1x 6034852	8x 4142865	1x 6477141	1x 6446030	4x 6074890	2x 6340042	2x 6263971
			11x 4113916	1x 6484474	8x 6478177	1x 383526	7x 6420468	4x 6253425	3x 6247798
					1x 6325525	1x 6177083	1x 6315782	1x 6265679	2x 6443797
							14x 6502193	1x 6340118	1x 6466045
							1x 6374150		

































  
 1x 6246876  
  
 2x 6289455  
  
 2x 6173802  
  
 3x 6247785  
  
 1x 6254563  
  
 1x 6326099  
  
 3x 6247793  
  
 1x 6238674  
  
 1x 6144130  
  
 2x 6211973  
  
 3x 6214234  
  
 1x 6223631  
  
 1x 6240515  
  
 3x 6213782















  
 1x 6484468  
  
 1x 6484449  
  
 4x 6400305  
  
 6x 6138232  
  
 1x 6057880  
  
 2x 6273590  
  
 1x 6484469  
  
 1x 4598955  
  
 24x 6250168  
  
 1x 6449564  
  
 8x 6132768  
  
 1x 6484237  
  
 2x 6035540  
  
 2x 6476339  
  
 2x 6476339  
  
 2x 4550329

















  
 1x 6022043  
  
 2x 6275088  
  
 1x 6001001  
  
 2x 6425446  
  
 1x 6316277  
  
 2x 4613196  
  
 1x 6484286  
  
 2x 6230571  
  
 4x 6403175  
  
 5x 6221730  
  
 2x 6262238  
  
 9x 6423384  
  
 5x 6416003  
  
 3x 6168645  
  
 2x 6311890  
  
 2x 4531415  
  
 1x 6083977















  
 2x 4652205  
  
 2x 6390504  
  
 1x 6411592  
  
 1x 6484475  
  
 1x 6486482  
  
 5x 6221729  
  
 1x 6223237  
  
 2x 4616578  
  
 37x 4655080  
  
 2x 6278553  
  
 3x 6168645  
  
 2x 6311890  
  
 2x 4531415  
  
 1x 6083977















  
 1x 4585751  
  
 1x 6440195  
  
 2x 6357747  
  
 4x 6245265  
  
 1x 6466832  
  
 25x 6214457  
  
 80x 6289747  
  
 1x 6061685  
  
 2x 6023173  
  
 53x 4282860  
  
 1x 6474228  
  
 1x 6486486  
  
 1x 6328059  
  
 80x 6289745  
  
 3x 6227662

  
 2x 6227663  
  
 1x 6096091  
  
 2x 6024286  
  
 5x 6330901  
  
 22x 6145215  
  
 2x 6028736  
  
 32x 4622062  
  
 2x 6134634  
  
 22x 6138731  
  
 22x 6478178  
  
 2x 6003033  
  
 26x 6099730  
  
 1x 6131583  
  
 7x 6099725  
  
 1x 6484476

  
 19x 6020073  
  
 3x 6482364  
  
 1x 6416696  
  
 2x 4621543  
  
 22x 6365966  
  
 1x 6186542  
  
 1x 6418392  
  
 2x 6430391  
  
 6x 6192205  
  
 9x 6133817  
  
 12x 6422088  
  
 7x 6186673  
  
 1x 4211183  
  
 6285623

  
 4x 4529242  
  
 5x 6215659  
  
 2x 4626196  
  
 2x 4504376  
  
 3x 4211242  
  
 8x 6348057  
  
 1x 4620075  
  
 1x 6227107  
  
 4x 6401027  
  
 5x 6433717  
  
 8x 6478179  
  
 17x 6248944  
  
 8x 6337003  
  
 3x 6278989  
  
 2x 6036503  
  
 1x 6182435  
  
 2x 6102360

  
 3x 4211166  
  
 12x 6172757  
  
 3x 4270443  
  
 8x 4531751  
  
 1x 6469349  
  
 1x 6382102  
  
 2x 6291040  
  
 4x 6103004  
  
 2x 6172808  
  
 4x 6345000  
  
 3x 6433392  
  
 1x 6248854  
  
 2x 4211150  
  
 8x 6226436  
  
 4x 4215449

  
 4x 6269077  
  
 6x 6167644  
  
 17x 6196221  
  
 1x 4211202  
  
 20x 6470170  
  
 1x 4211152  
  
 2x 6251470  
  
 10x 6186577  
  
 3x 6055086  
  
 1x 6100769  
  
 1x 6316282  
  
 1x 6484263  
  
 6x 6328480  
  
 2x 6168623

1x  
6116613



2x  
6258989



1x  
6234270



1x  
6313665



6x  
4217848



1x  
4223683



2x  
6469351



1x  
4223729



2x  
6055145



5x  
6170468

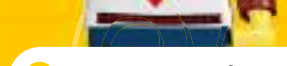

1x  
4211181



2x  
6055145

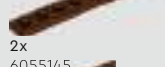

5x  
6170468



2x  
6357946



2x  
4211204



1x  
4655611



1x  
6476005

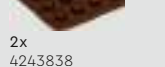

2x  
4243838

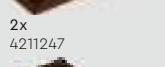

2x  
4211247

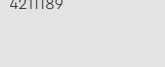

4x  
4211189

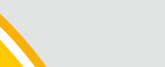

1x  
4211181

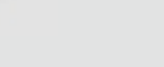

4x  
4595889

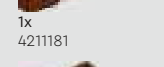

7x  
6153594

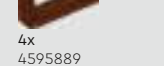

1x  
4224732

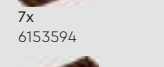

2x  
6044725

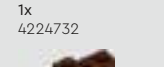

13x  
6250597

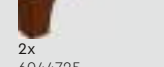

6x  
6448793

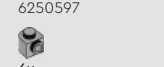

1x  
6057487

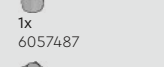

1x  
4211389



2x  
6311384

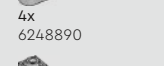

4x  
6248890

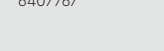

1x  
6390506

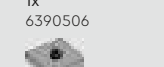

2x  
6126082



2x  
6034676

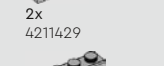

2x  
4211429



2x  
6314891

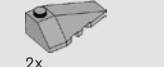

2x  
6013497



2x  
4180418

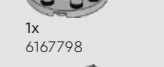

4x  
4509915

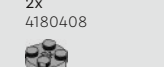

1x  
6167798

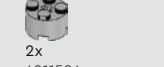

2x  
4180408

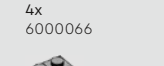

4x  
4211475

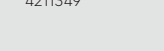

2x  
4515374

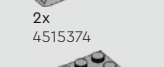

5x  
4211385

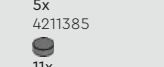

11x  
6284596



3x  
6199549

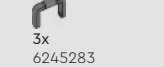

6x  
6228923



3x  
6245283

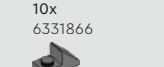

2x  
6221607



2x  
6178919

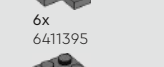

10x  
6331866



2x  
6069164

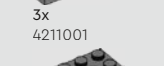

4x  
4211007

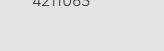

7x  
6209683



1x  
6440633

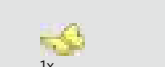

1x  
6379176



1x  
6440631

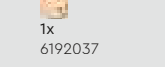

1x  
6192037

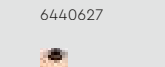

1x  
6440627



1x  
6476347

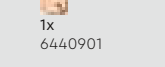

1x  
6476353

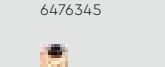

1x  
6440901

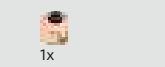

1x  
6476345

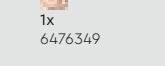

1x  
6476343

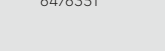

1x  
6274711

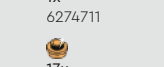

17x  
6190252

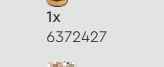

1x  
6372427

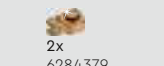

4x  
6069887

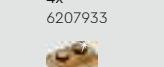

2x  
6284379

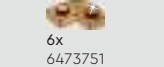

4x  
6207933

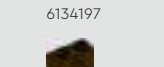

4x  
6338242

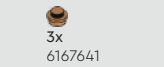

6x  
6473751

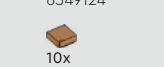

2x  
6134197

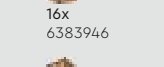

2x  
6272144



3x  
6167641

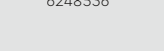

37x  
6292154

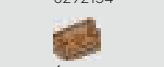

6x  
6167642

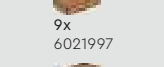

9x  
6021997

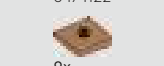

14x  
6474122

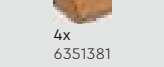

9x  
6102994

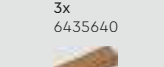

4x  
6351381

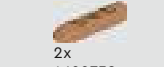

3x  
6435640

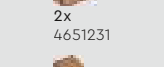

3x  
6365746



2x  
4622738

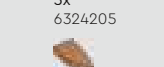

2x  
4651231

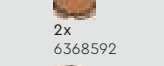

2x  
6454169

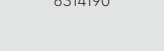

17x  
6177146



10x  
6177146

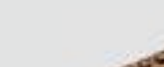

16x  
6383946

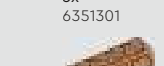

12x  
6476342



2x  
6296061



6x  
6248536

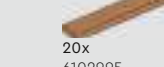

6x  
6167642



9x  
6021997



14x  
6474122

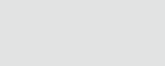

9x  
6102994



4x  
6351381

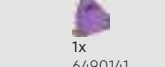

3x  
6435640

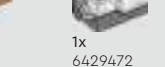

3x  
6365746

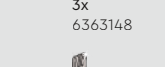

2x  
4622738



2x  
4651231

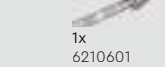

2x  
6454169

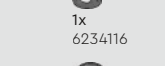

1x  
6287960



2x  
6151658



2x  
6137300

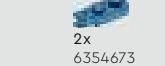

2x  
6354673

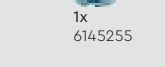

1x  
6145255

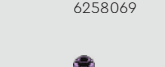

2x  
6258069

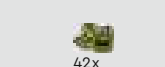

21x  
6214235



42x  
6398008

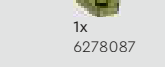

2x  
6100158

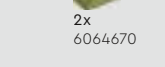

1x  
6278087

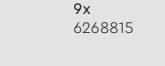

2x  
6064670

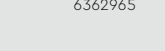

LEGO.com/service



# YOU COULD WIN



## YOU COULD WIN

Your feedback will help shape the future development of this product series.

Visit:

## DU KÖNNTEST GEWINNEN

Dein Feedback trägt zur Weiterentwicklung dieser Produktreihe bei.

Geh auf:

## VOUS POURRIEZ GAGNER

Vos commentaires nous aideront à concevoir les futurs produits de cette gamme.

Visitez :

## POTRESTI VINCERE TU

La tua opinione ci aiuterà a migliorare la creazione futura di questa linea di prodotti.

Visita:

## PUEDES GANAR

Tu opinión contribuirá al futuro de esta serie de productos.

Visita:

## 轻松获奖

您的反馈将有助于我们在今后改进本产品系列。

请访问:

---

[LEGO.com/productfeedback](https://www.lego.com/productfeedback)

---

You also have the chance to win a LEGO® set.

Terms and conditions apply.\*

Außerdem hast du die Chance, ein LEGO® Set zu gewinnen.

Es gelten die Teilnahmebedingungen.\*

Vous pourriez également gagner un ensemble LEGO®.

Des conditions s'appliquent.\*

Hai anche la possibilità di vincere un set LEGO®.

Termini e condizioni sono applicabili.\*

También tienes la oportunidad de ganar un set LEGO®.

Aplican términos y condiciones.\*

您还有机会赢取乐高®套装。

条款和条件适用。\*

\*[LEGO.com/productfeedback-terms](https://www.lego.com/productfeedback-terms)



