



# DREAMZZZ

71472



Q LEGO® Builder



[LEGO.com/sustainable-packaging](https://LEGO.com/sustainable-packaging)



**FR**  
**DONNEZ**  
OU  
**RECYCLEZ**

 OU  OU 

ASSOCIATION    MAGASIN    DÉCHÈTERIE

Adresses sur [quefairedemesdechets.fr](https://quefairedemesdechets.fr)



Q LEGO® Builder

# BUILDER



Apple and the Apple logo are trademarks of Apple Inc., registered in the U.S. and other countries and regions. App Store is a service mark of Apple Inc. Google Play and the Google Play logo are trademarks of Google LLC. Tencent and the Tencent logo are trademarks of Tencent Inc.

Q [LEGO.com/devicecheck](https://LEGO.com/devicecheck)

**EN** Ask parents' permission before going online | **DE** Eltern um Erlaubnis bitten, bevor du online gehst | **FR** Demande l'autorisation d'un parent avant d'aller en ligne | **IT** Chiedi il permesso ai tuoi genitori prima di andare online | **ES** Pídeles permiso a tus papás antes de conectarte a Internet | **PT** Pede autorização aos pais antes de acederes online | **ZH** 上网前应先征得父母的同意 | **PL** Poproś rodziców o zgodę, zanim wejdiesz do Internetu | **CS** Než půjdeš na internet, požádej rodiče o svolení | **SK** Skôr než pôjdeš na internet, vypýtaj si povolenie od rodičov | **HU** Kérj szülői engedélyt, mielőtt online csatlakoznál! | **RO** Cere permisiunea părinților înainte de a te conecta online | **BG** Поискайте разрешение от родител, преди да влезете онлайн | **LV** Pirms došanās tiešsaistē palūdz atļauju vecākiem | **ET** Enne Interneti kasutamist küsi vanematelt luba | **LT** Prieš prisijungdami prie interneto, atsiklauskite tėvų









1

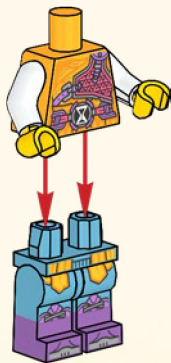

2

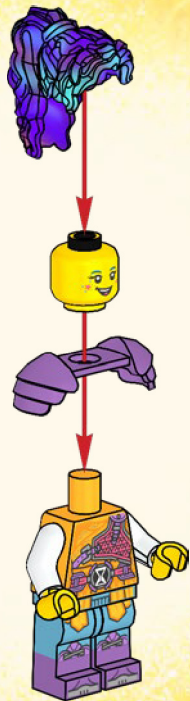

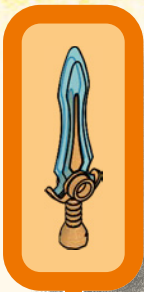

3







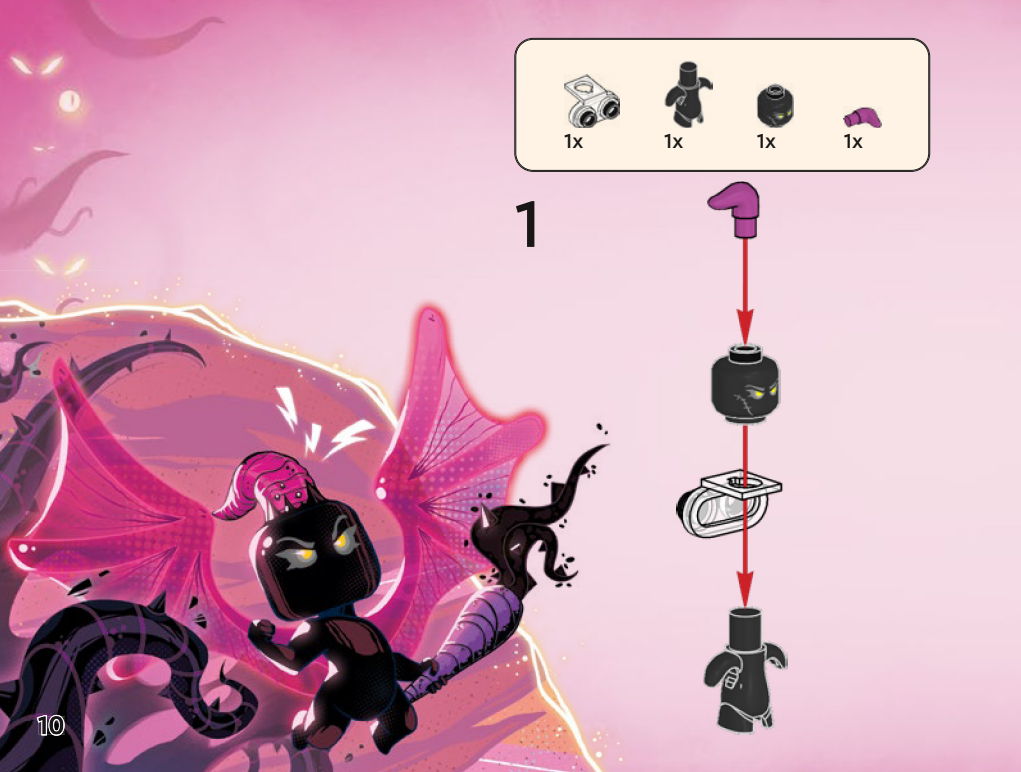

1x



1x



1x



1x

1





2x

2

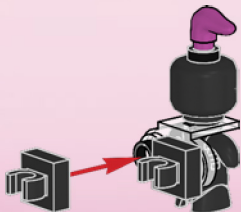

2x

3

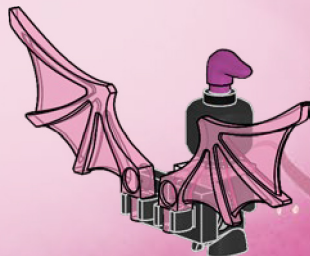



1x



1x

4

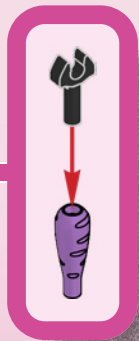
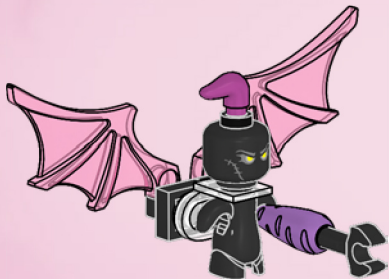







1x



1x

1

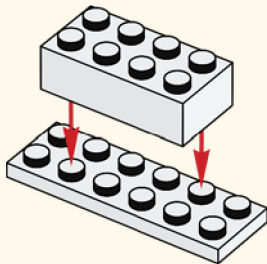

1x



2x

2

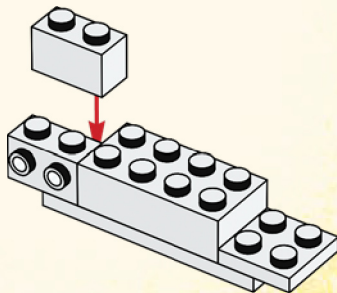



2x

3

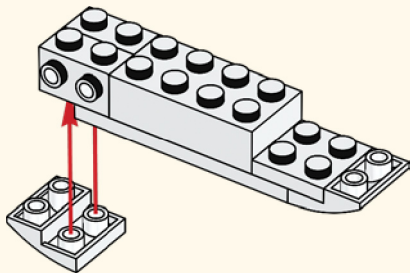





1x



1x

4

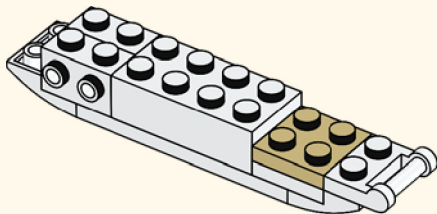



1x



1x

5

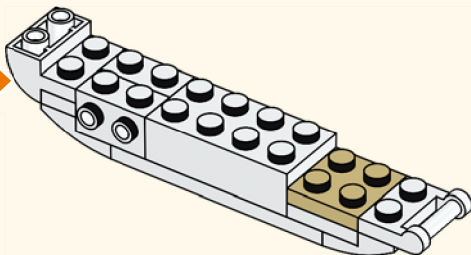
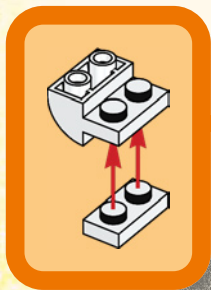



1x



2x



1x

6

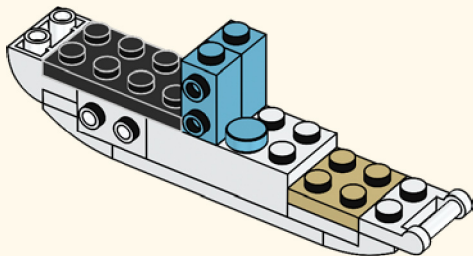



2x



2x

7

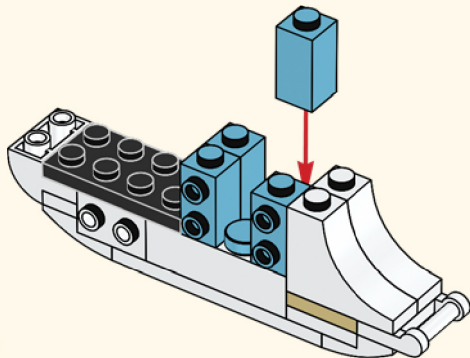



1x



1x

8

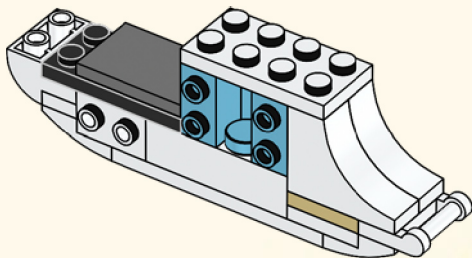

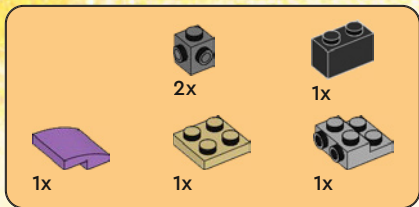

9

1

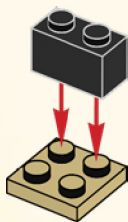

2



3

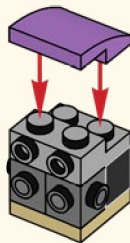

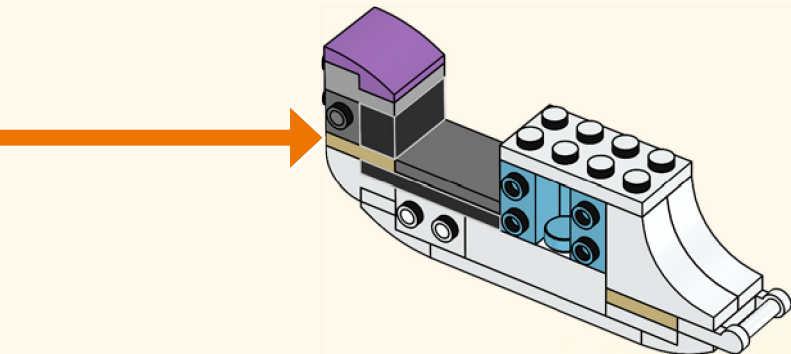

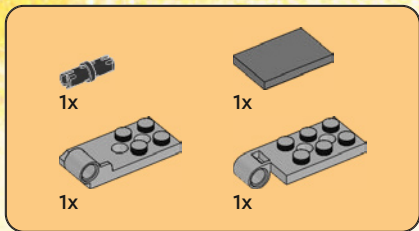

# 10

## 1

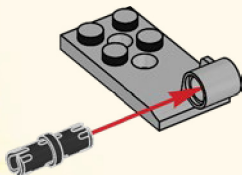

## 2

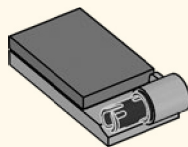



3

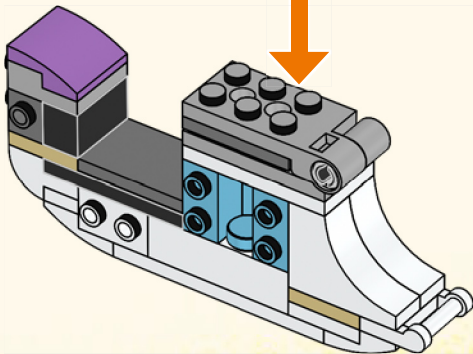
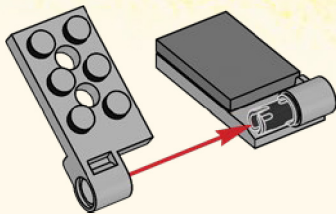



1x



1x

# 11

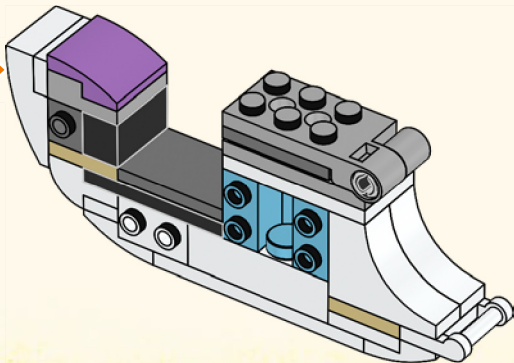
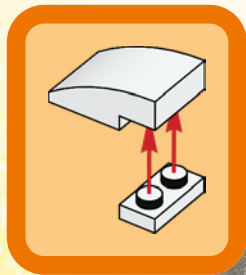



2x

# 12

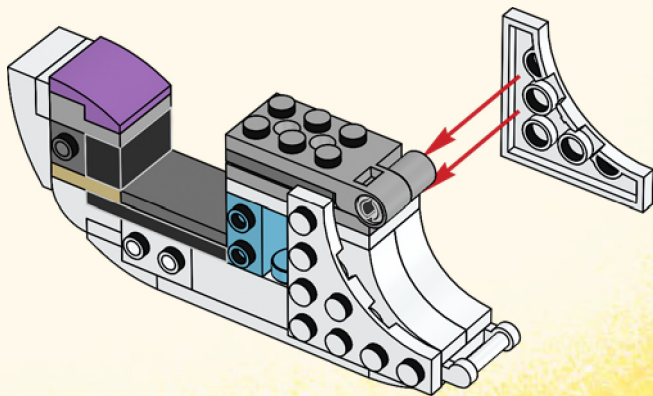

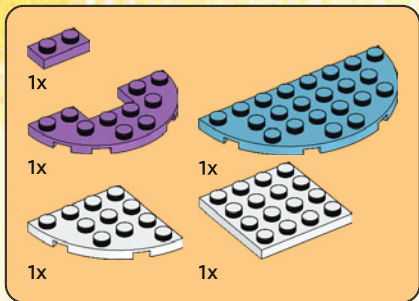

13

1



2

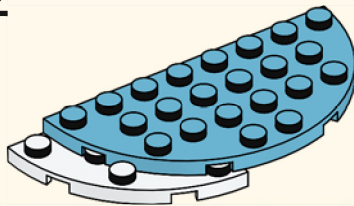



3

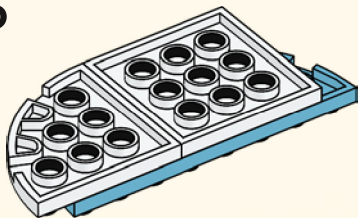

4

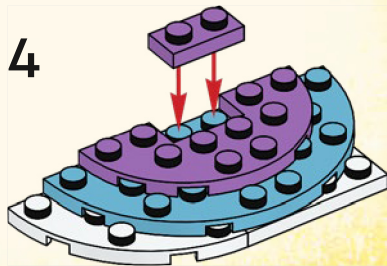

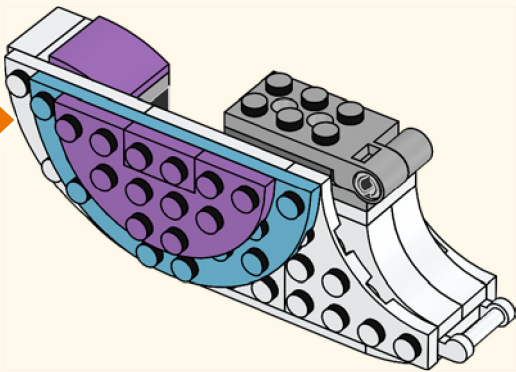

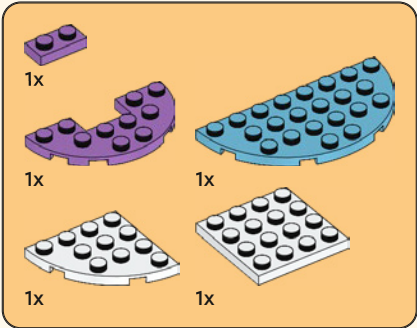
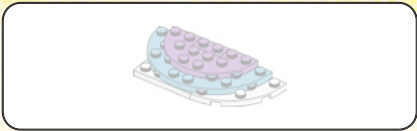

14

1



2

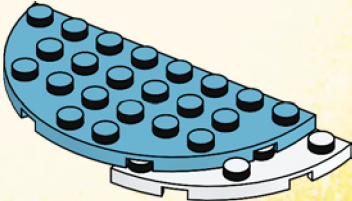

3

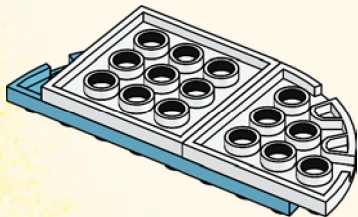

4

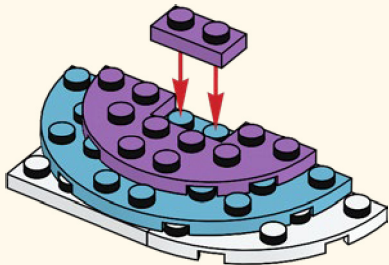



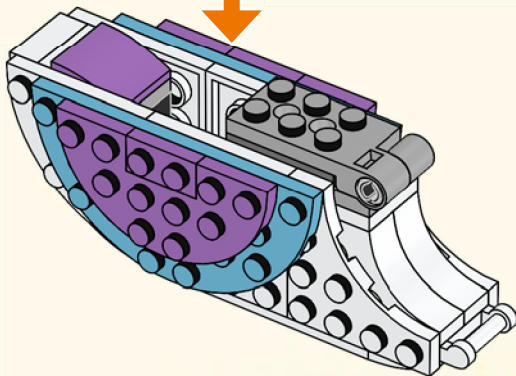

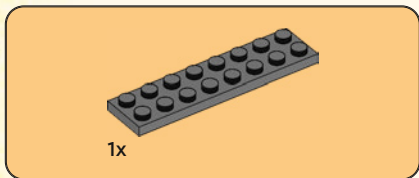
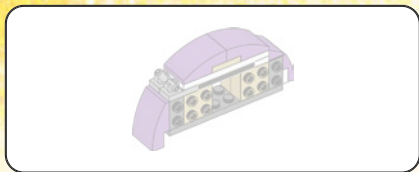

15

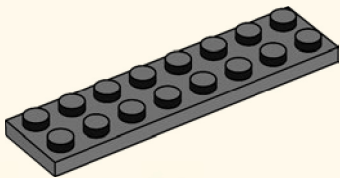



4x



2x

# 16

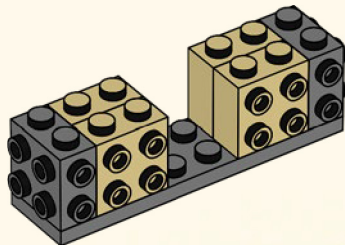



1x



1x

17

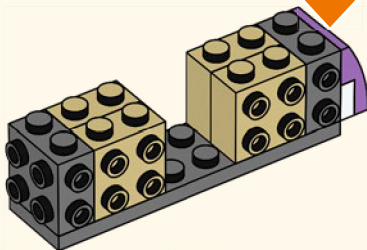
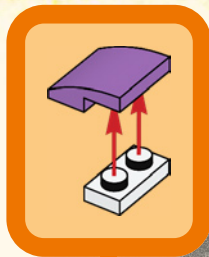



1x



1x

18

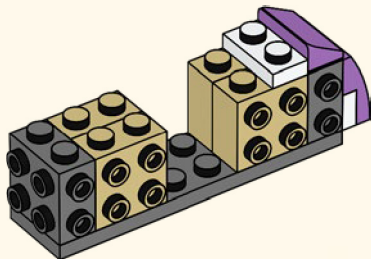

1x



2x

19

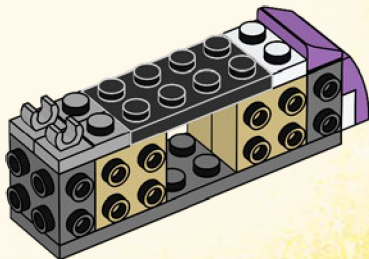



20

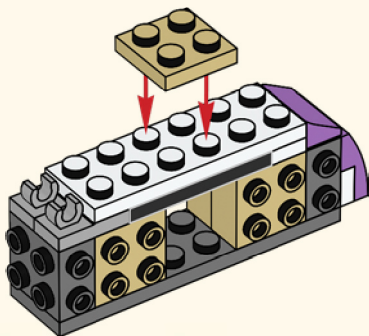



2x

21

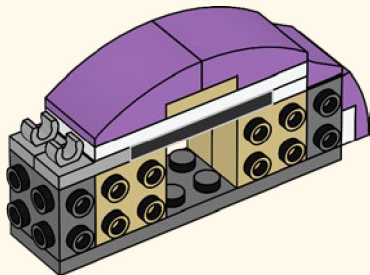

1x

22

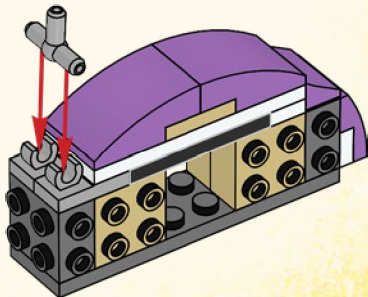



1x

23

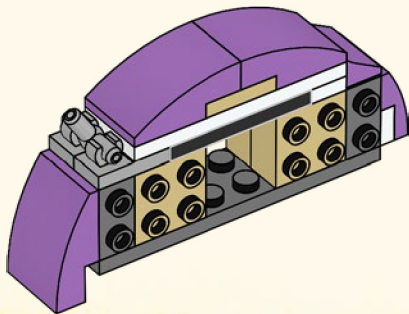



24

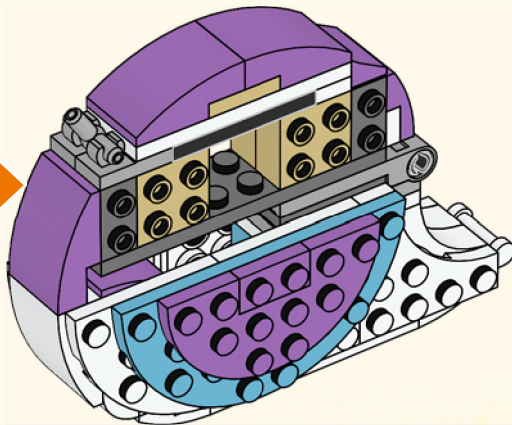

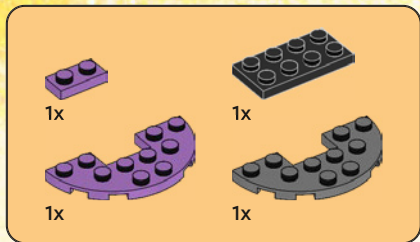

25

1

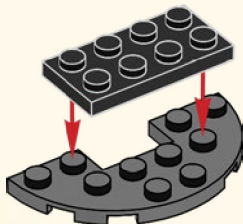

2

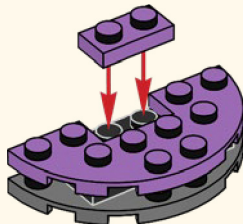

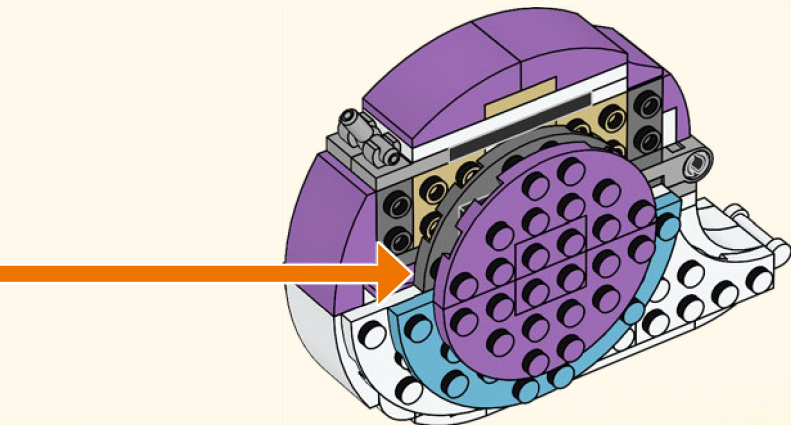



2x

26

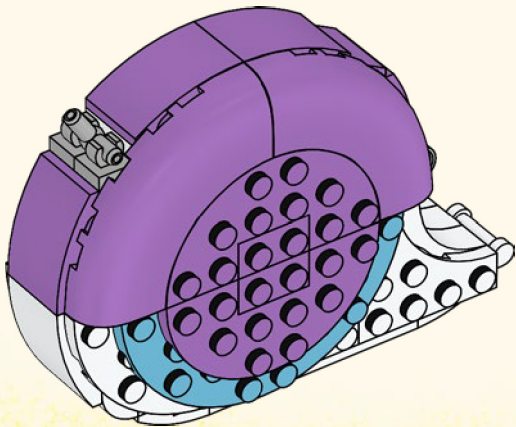



2x



1x

27

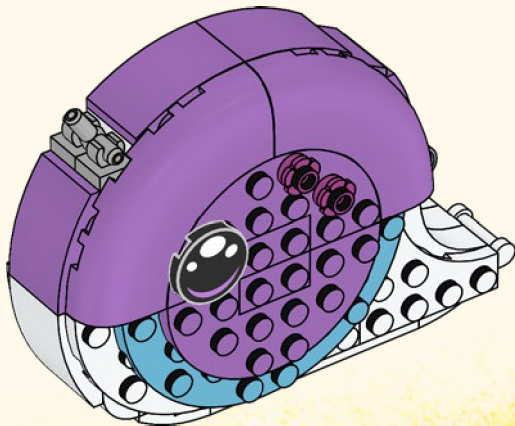

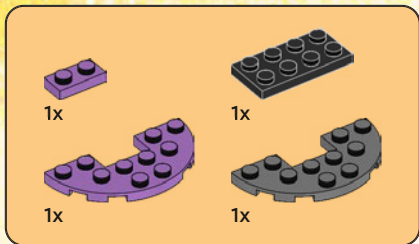

# 28

1

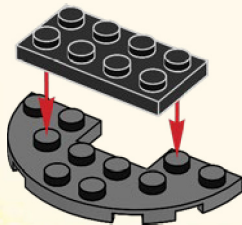

2

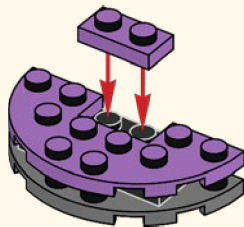

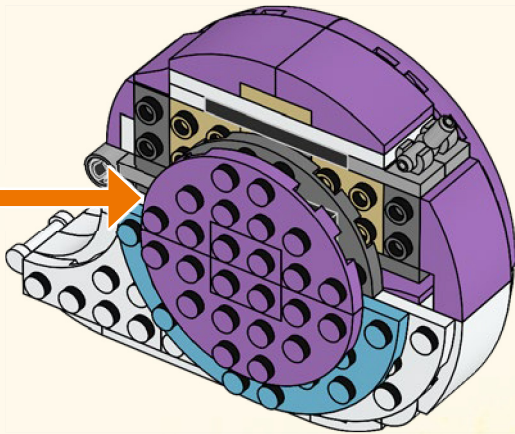



2x

29

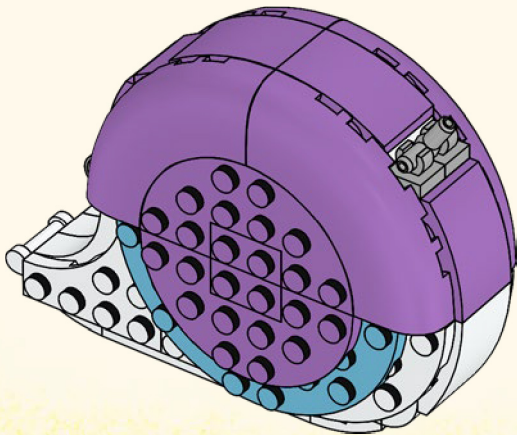





2x



1x

# 30

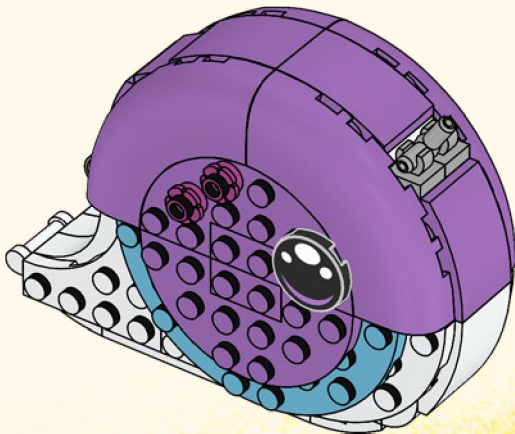

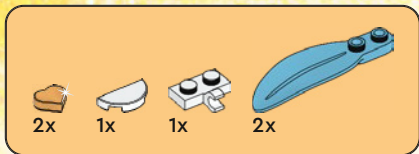

# 31

1



2

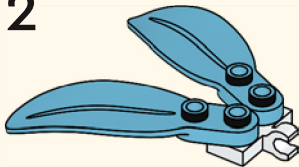

3

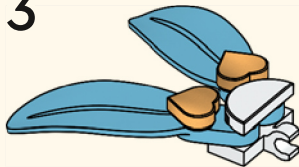

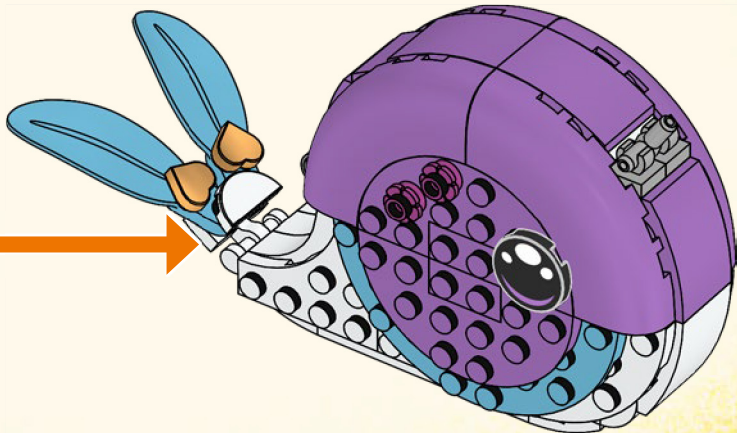



2x



2x



2x



2x



2x



2x



2x

32

1

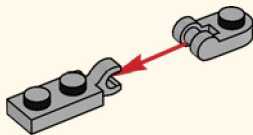

2

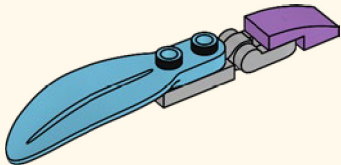

3

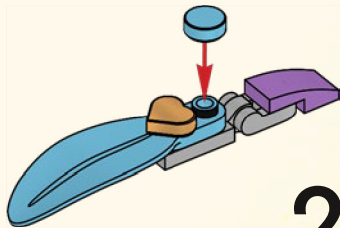

2x

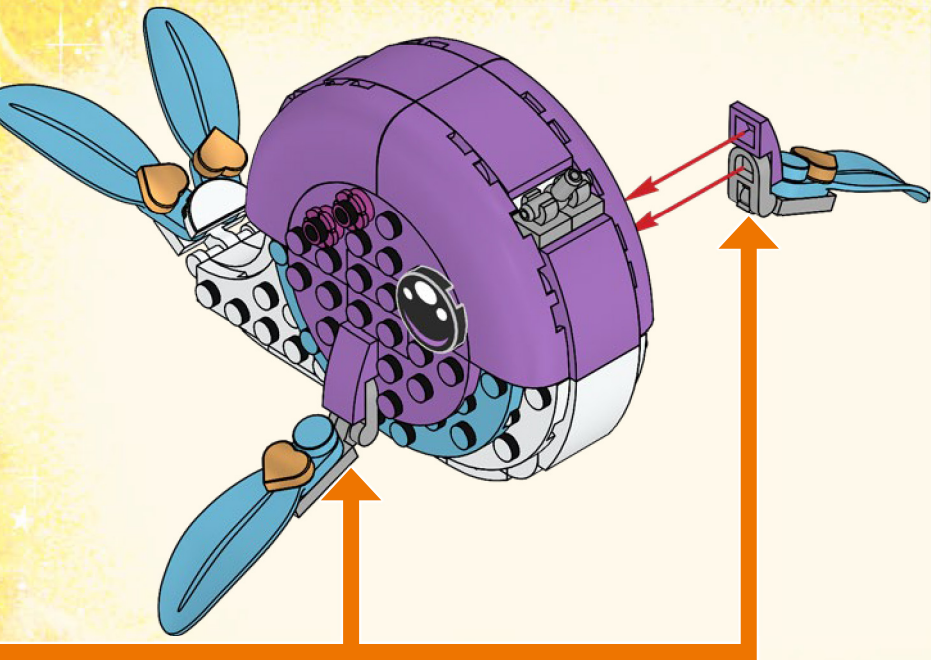



1x



1x

# 33

1



2



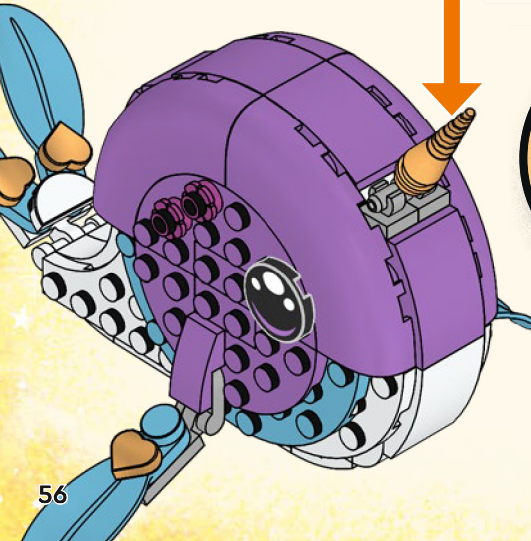









1x



1x

1

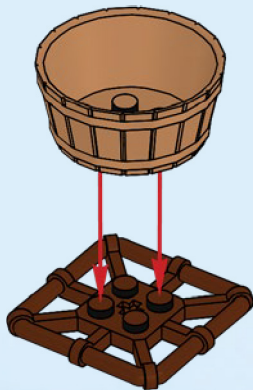

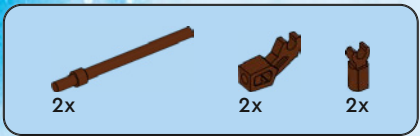

2

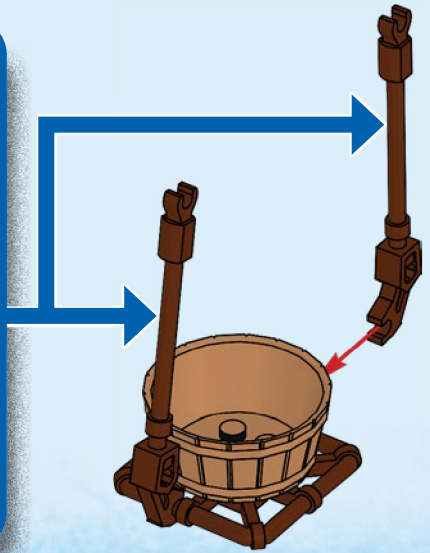
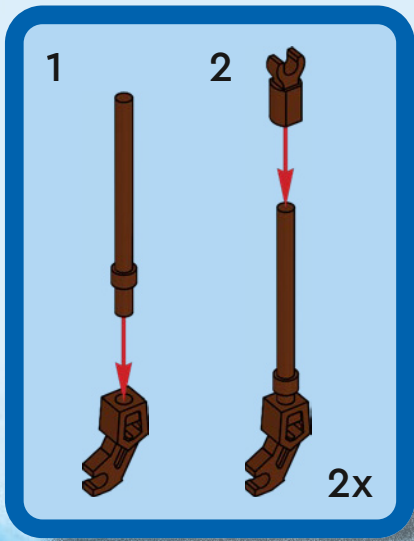

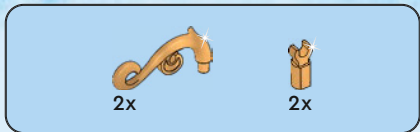

3

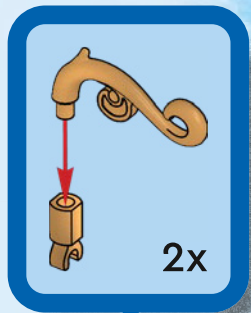
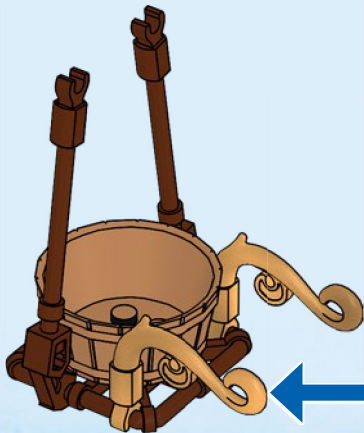

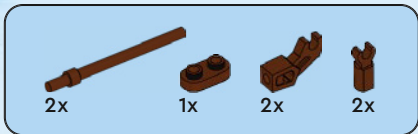
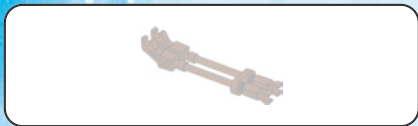

4

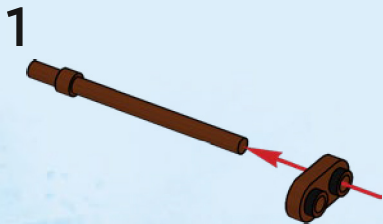

2

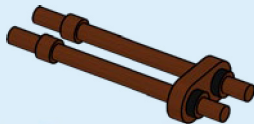

3

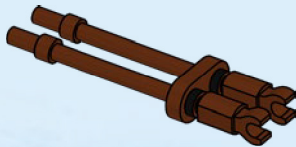

4

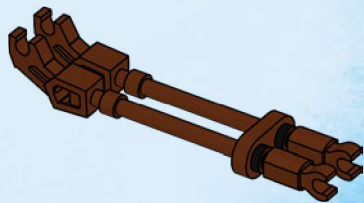

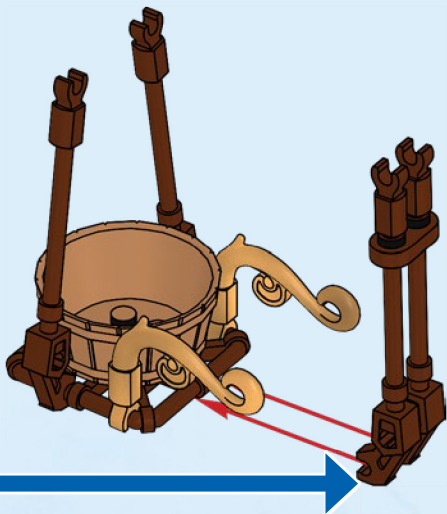



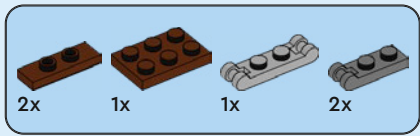

5

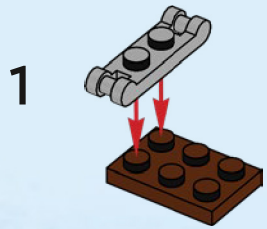

2



3

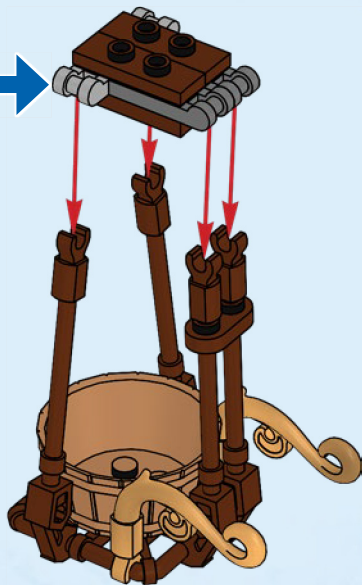
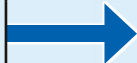
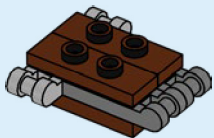



1x



1x



1x

6

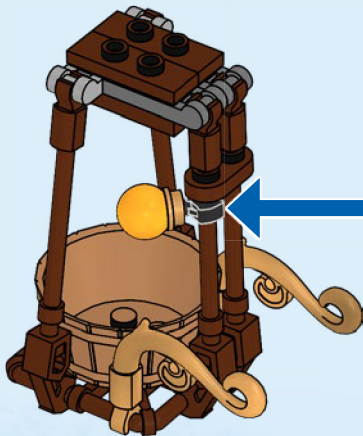

1



2





1x



1x



1x

7

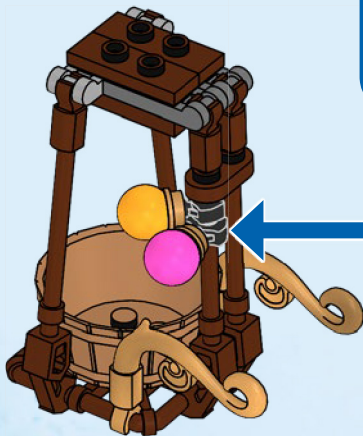

1



2



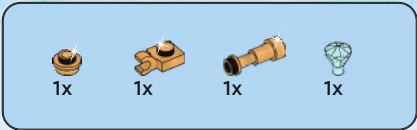

8

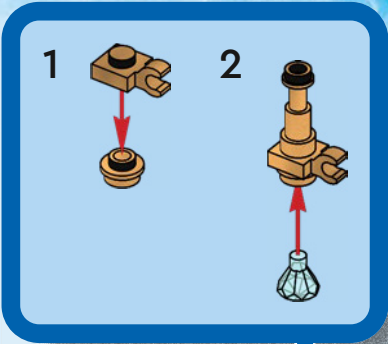
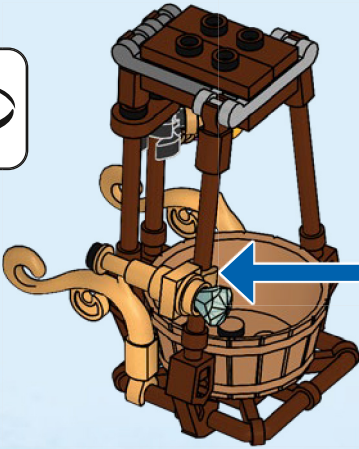

9

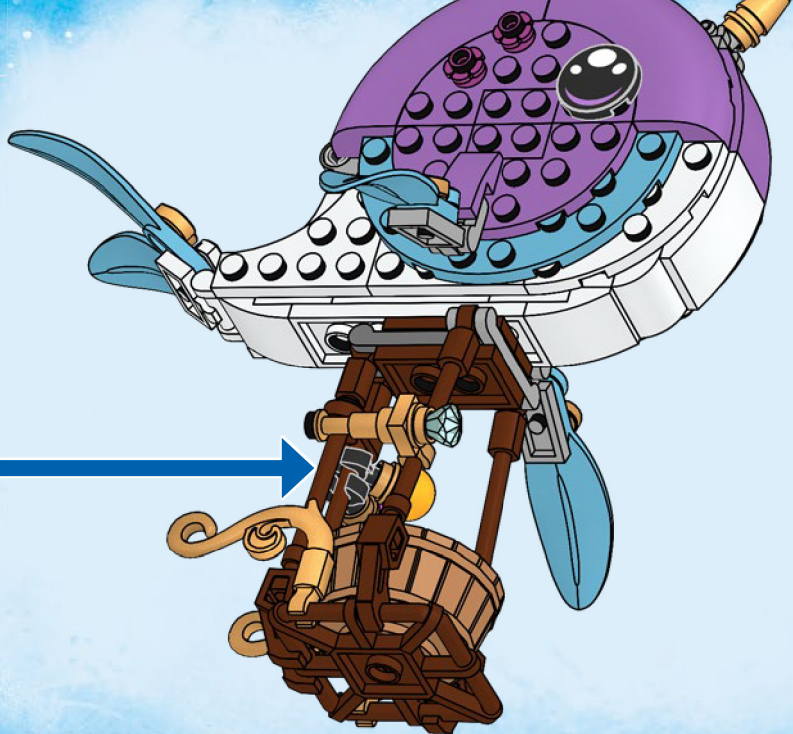









1x



1x

1





2

1

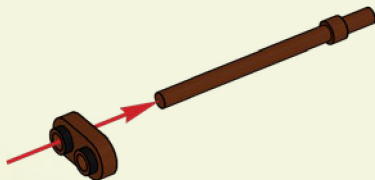

2

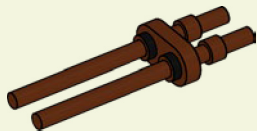

3

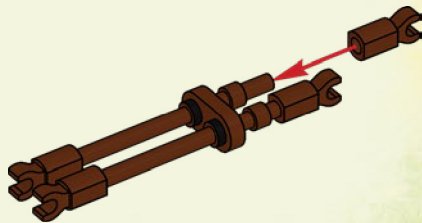

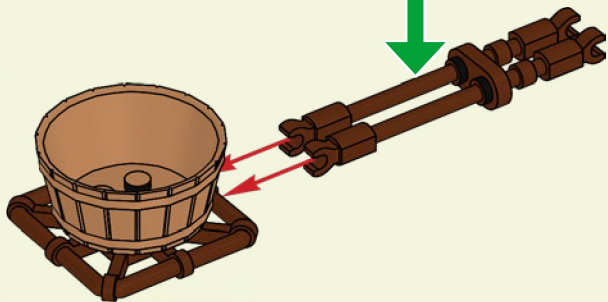

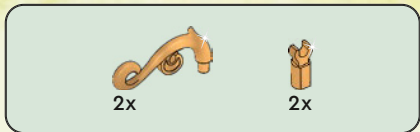

3

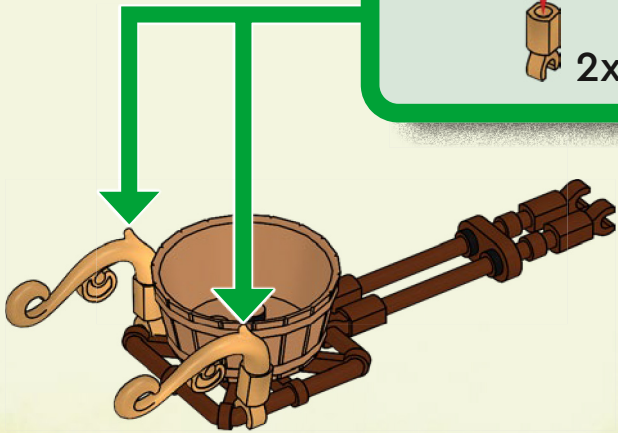
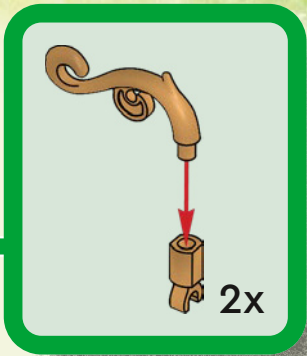



2x



2x



2x

4

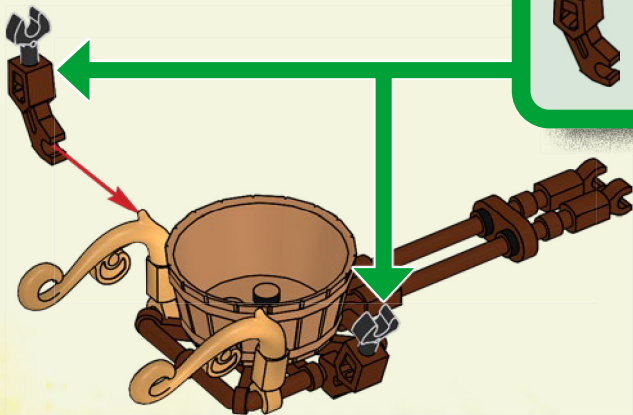

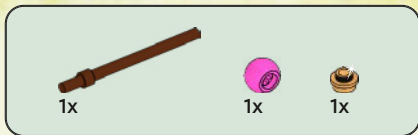

5

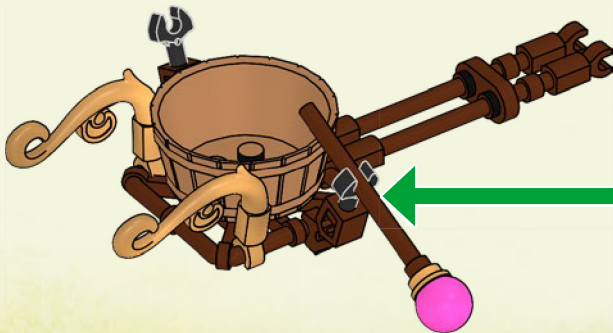
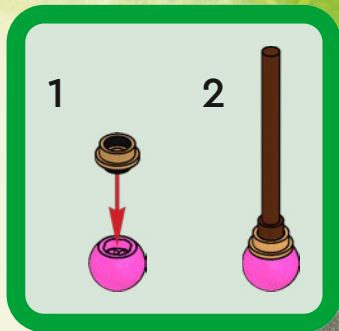

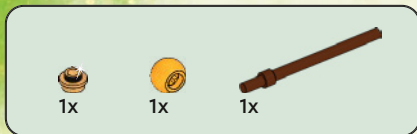

6

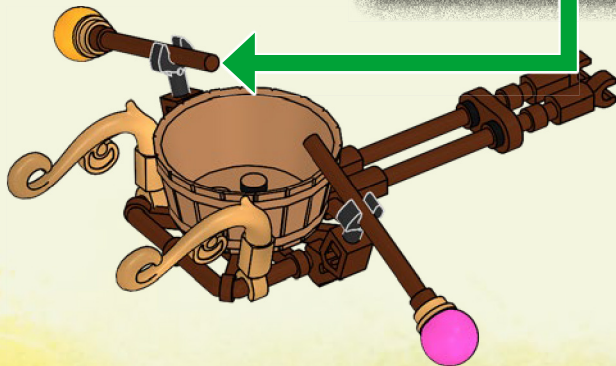
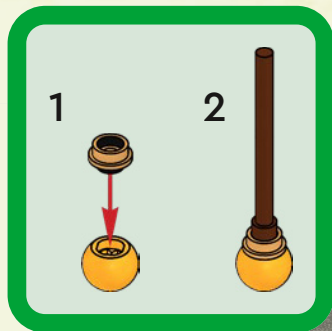





1x



1x



1x



1x

7

1



2

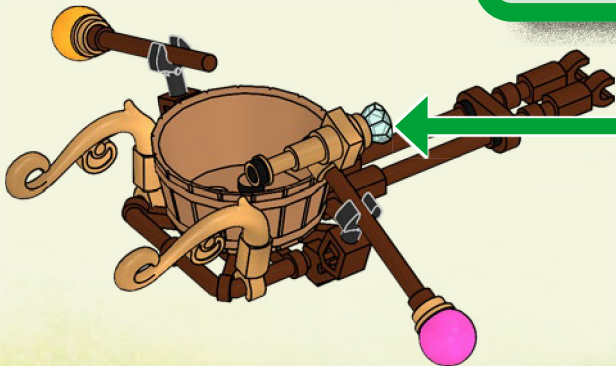

8

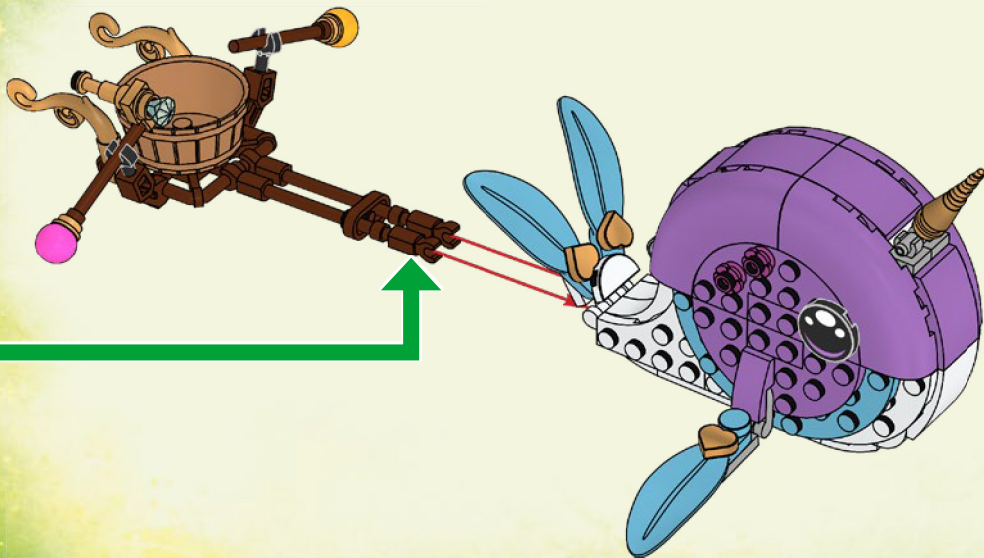



**LEGO**

**DREAMZZZ**



**71471**



**71472**



**71475**



**71476**



**71477**

Watch series online  
Schau dir die Serie online an  
Regarde la série en ligne  
Guarda la serie online  
Mira la serie en Internet  
Assistir à série online  
在线观看剧

Oglądaj serial w internecie  
Sleduj seriál online  
Pozri si seriál online  
Nézd a sorozatot online  
Vizionează serialul online  
Глядите сериала онлайн  
Skaties seriālu tiešsaistē  
Vaata sarja veebist  
Žiūrėk serialą internetu



# DREAMZZZ

WATCH  
SERIES  
ONLINE



LEGO.com/DREAMZZZ



1x  
6400114



2x  
6058177



4x  
302301



1x  
6313115



1x  
4222017



1x  
302201



1x  
6400127



2x  
6210385

86



2x  
6110019



1x  
6132212



1x  
300101



1x  
302001



2x  
4243812



2x  
6254335



2x  
4178429



2x  
379501



4x  
6214334



3x  
4114084



1x  
6434190



3x  
6439039



1x  
6434214



2x  
6335388



1x  
6430884



1x  
6279875



1x  
300426



2x  
6469662



4x  
302026



1x  
6166106



1x  
6247792



2x  
6207783



4x  
6209682



1x  
6328192



1x  
6071608



1x  
6443633



4x  
6341968



1x  
6248944



3x  
6322819



4x  
6465292



1x  
6434193



1x  
6434192



4x  
6470919



2x  
6138571



4x  
6276868



2x  
6251470



1x  
4211189



4x  
6170468



1x  
6300124



1x  
4211508



2x  
6225246



2x  
6326078



2x  
6319336



1x  
6469440



1x  
6093058



1x  
6258903



1x  
6256117



1x  
6228091



2x  
6332045



2x  
6314192



2x  
4521187



2x  
6187008



2x  
6218084



1x  
4210997



1x  
6214208



1x  
6143217



2x  
6252838



4x  
6190252



1x  
4529247



4x  
6301811



1x  
6430886



1x  
6284379



1x  
4538126



2x  
6172437



1x  
6335182



1x  
6398503



4x  
4619512



2x  
6136331



2x  
6139090



1x  
6443457



3x  
6470194



1x  
6430878



4x  
6470187



4x  
6470195



 [LEGO.com/service](https://www.LEGO.com/service)

**YOU COULD**  
**WIN**



Scan this QR code or go to  
**LEGO.COM/PRODUCTFEEDBACK** and give us  
your short feedback about this LEGO® set  
for a chance to win a cool LEGO prize.

Terms and Conditions apply\*

**EN: YOU COULD WIN.** Terms and Conditions apply\* **DE: Du könntest GEWINNEN.** Es gelten die Teilnahmebedingungen\* **FR: Tu pourrais GAGNER.** Des conditions s'appliquent\* **IT: Potresti VINCERE tu.** Termini e condizioni sono applicabili\* **ES: Puedes GANAR.** Aplican términos y condiciones\* **PT: Poderá GANHAR.** Aplicam-se termos e condições\* **ZH: 轻松获奖. 条款和条件适用\*** **PL: Szansa na WYGRANĄ.** Obowiązują warunki korzystania\* **CS: Máte šanci VYHRÁT.** Platí všeobecné smluvní podmínky\* **SK: Máte šancu VYHRÁT.** Platia všeobecné zmluvné podmienky\* **HU: TE IS NYERHETSZ.** Felhasználási feltételek érvényesek\* **RO: Ai putea CÂȘTIGA.** Se aplică termeni și condiții\* **BG: Можете да СПЕЧЕЛИТЕ.** Има определени правила и условия\* **LV: Tu vari LAIMĒT.** Ir spēkā noteikumi un nosacījumi.\* **ET: Sul on võimalus VÕITA.** Kehtivad tingimused\* **LT: Jūs galite LAIMĖTI.** Taikomos sąlygos\*

\*[LEGO.com/productfeedback-terms](https://www.lego.com/productfeedback-terms)

LEGO, the LEGO logo and DREAMZzz are trademarks of the LEGO Group.  
©2024 The LEGO Group.

6494353