

Booklet available in English on
Heft in deutscher Sprache erhältlich auf
Livret disponible en français sur
Libretto disponibile in italiano su
Folleto en español disponible en
如需中文版手册, 请访问



FR
**DONNEZ
OU
RECYCLEZ**

ASSOCIATION
OU

MAGASIN
OU

DÉCHÈTERIE

Adresses sur quefairede_mesdechets.fr



LEGO.com/sustainable-packaging

LEGO® VIP

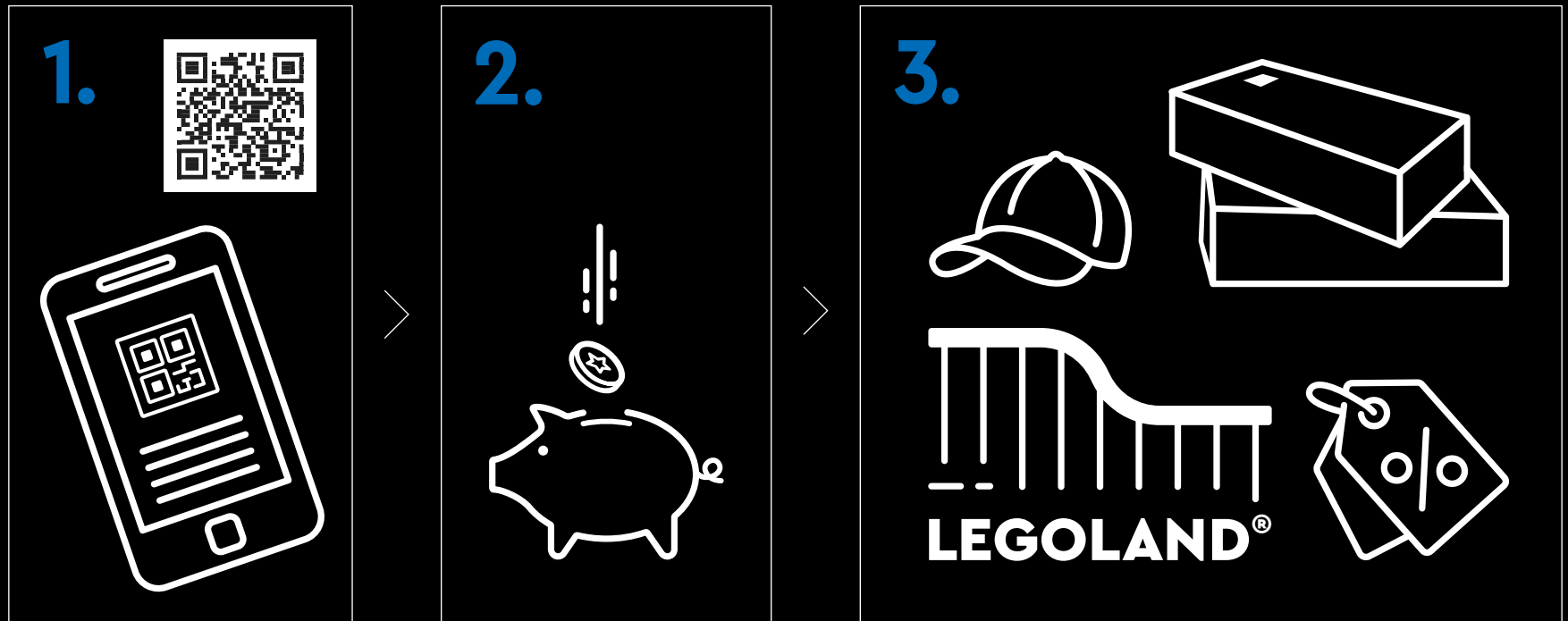

1. Sign up **2.** Earn points for purchases **3.** Redeem points for rewards, experiences, discounts & more | **1.** Melde dich an **2.** Sammle Punkte bei jedem Kauf **3.** Löse die Punkte für Belohnungen, Erlebnisse, Rabatte und Ähnliches ein | **1.** Inscrivez-vous **2.** Gagnez des points lors de vos achats **3.** Échangez vos points contre des récompenses, des expériences, des remises et bien plus encore | **1.** Iscriviti **2.** Guadagna punti con i tuoi acquisti **3.** Riscatta punti per premi, esperienze, sconti e altro ancora | **1.** Regístrate **2.** Gana puntos por tus compras **3.** Canjea puntos por recompensas, experiencias, descuentos y mucho más | **1.** Registe-se **2.** Ganhe pontos em compras **3.** Troque os pontos para prêmios, experiências, descontos e muito mais | **1.** 注册 **2.** 购物赚积分 **3.** 用积分兑换奖励、体验、折扣等 | **1.** Zarejestruj się **2.** Zdobywaj punkty za zakupy **3.** Wymieniaj punkty na rabaty, przygody i inne nagrody | **1.** Zaregistrujte se **2.** Sbírejte body za nákupy **3.** Vyměňujte body za odměny, zážitky, slevy a spoustu dalšího | **1.** Zaregistrujte se **2.** Získavajte body za nákupy **3.** Uplatnite si body a získajte odmeny, rôzne zážitky, zľavy a ešte viac | **1.** Regisztrálj **2.** Szerezz pontokat minden vásárlással **3.** Váltsd be pontjaidat jutalmakra, élményekre, kedvezményekre és egyebekre | **1.** Înscric-te **2.** Câștigă puncte pentru achiziții **3.** Valorifică puncte pentru recompense, experiențe, reduceri și multe altele | **1.** Регистрируйте се **2.** Получайте точки за покупки **3.** Используйте точки за награды, услуги, отстъпки и т.н. | **1.** Reģistrējies **2.** Pelni punktus par pirkumiem **3.** Izmanto punktus, lai saņemtu balvas, izklaides iespējas, atlaides un daudz ko citu | **1.** Registreeru **2.** Teeni ostude eest punkte **3.** Lunasta punktide eest preemiad, elamused, allahindlused ja muu | **1.** Užsiregistruokite **2.** Pelnykite taškų už pirkinius **3.** Panaudokite taškus atlygiui, funkcijoms, nuolaidoms ir ne tik



WELCOME TO LEGO® ART

● From humble roots in pulp prints to a **cultural phenomenon** – the comic book genre has continually transformed storytelling through art. With innovative use of **graphic design** and **printing techniques**, **complex storylines** and **strongly defined characters**, it continues to influence pop art and other media. And now, for the fans, we're taking it **one step further** – create your own **Spider-Man comic panel** and immerse yourself in the **LEGO® Art experience**. PS: Don't miss the **amazing Soundtrack!**



APPLYING THE BEN DAY PROCESS

● **Did you know?** Comic books released between the 1930s and 1980s were often printed with techniques inspired by the **Ben Day process**. Developed for **newspaper comic strips** in 1879 – by illustrator and painter Benjamin Henry Day Jr. – the technique adds areas of colour to black and white prints by spacing **grids of coloured dots or lines**. Originally used to **save ink** and **reduce costs**, the Ben Day process has inspired generations of artists.

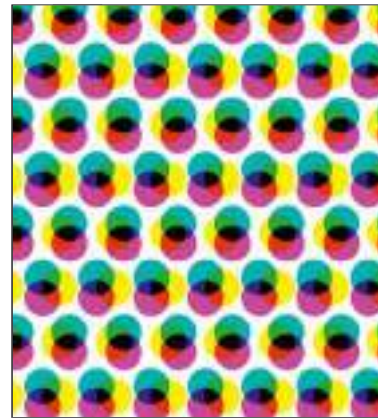

Ben Day-inspired
mid-century pop art

The technique recreated
with LEGO® elements



1962

ALONG CAME A SPIDER

● **Peter Parker** --- loveably awkward, gangly teen/friendly neighbourhood super hero --- first appeared in the August 1962 issue of **AMAZING FANTASY #15**. The character won the hearts of Marvel fans and soon featured in his first independent comic book **THE AMAZING SPIDER-MAN (1963) #1**. Written by comic book icon **Stan Lee** and illustrated by **Steve Ditko** and **Sol Brodsky**, the story follows Peter shortly after the death of his beloved **uncle Ben**.

The Amazing Spider-Man continues to weave a web of **dedicated fans** all over the world - Six decades on, he has starred in over **900** AMAZING SPIDER-MAN comic books, plus features, annuals, collections, newspaper strips, films, games, plays, TV series and more.





Iconic covers through the years



BUILD & DISPLAY – EDITOR'S NOTES:

● **AND NOW...** Before you begin, make sure you find a space **big** enough for the frame – and **sort** your LEGO® bricks. The **step-by-step guide** takes you through a **unique building experience** as you watch your Spider-Man comic panel **come to life!**





 **SOUNDTRACK**
Only in English



IMPORTANT BULLETIN!

● **Don't miss** the guided tour **behind the scenes** of your LEGO® Art Spider-Man set! Scan the QR code to play the **Soundtrack**, with designer interviews and anecdotes from the history of **Spider-Man comic books**.

DO YOU FEEL THAT?

Could it be your **Spidey-builder sense** tingling? You might notice we've used loads of **advanced math** to create a fun building experience – and that's just how Peter Parker would like it.

HAVE A GAS!

Reconnect with your inner **super hero** and spin yourself an Amazing Fantasy web of **creative art**.

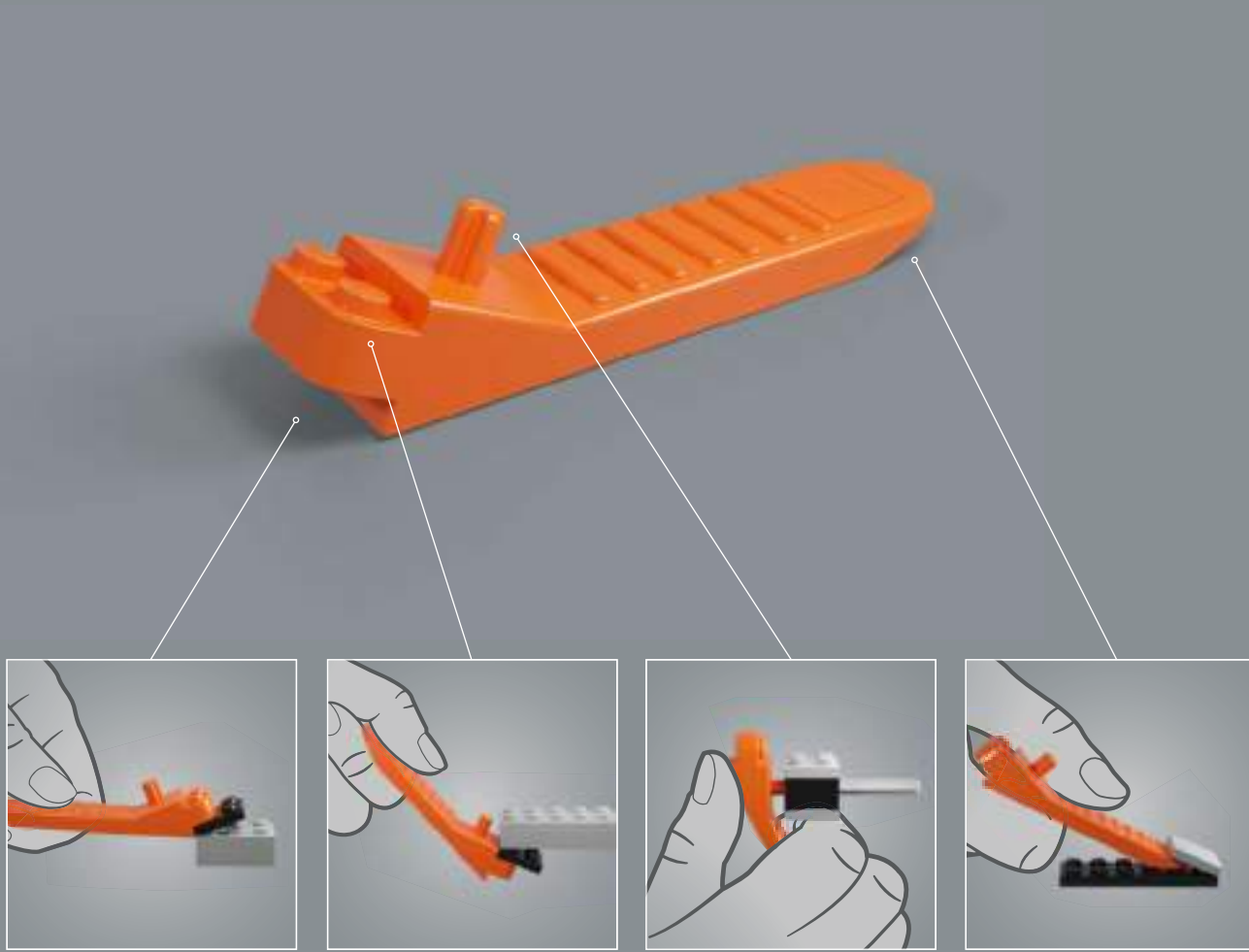

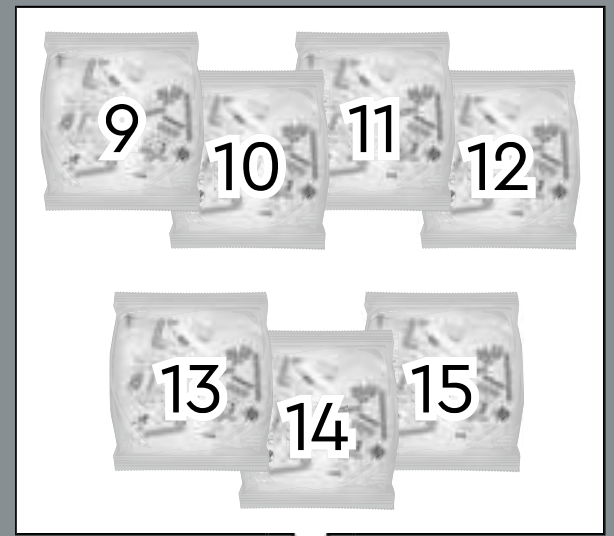
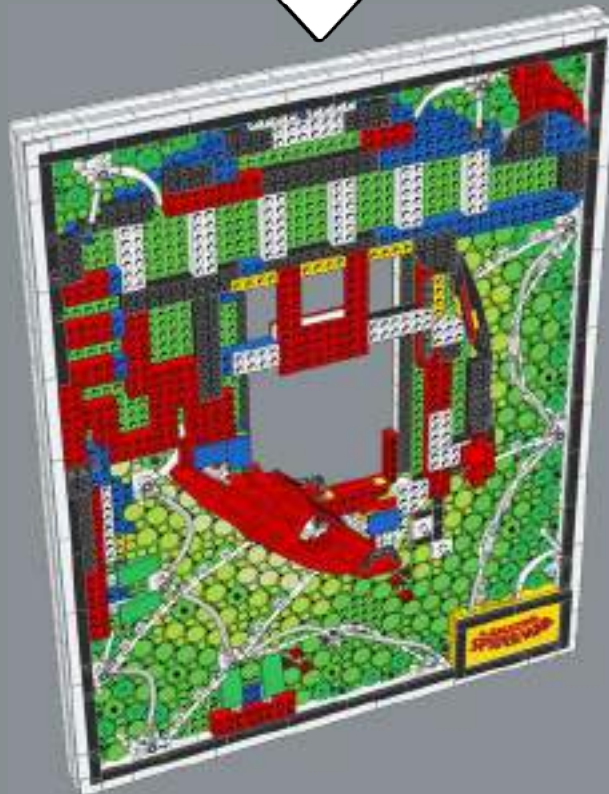
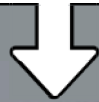
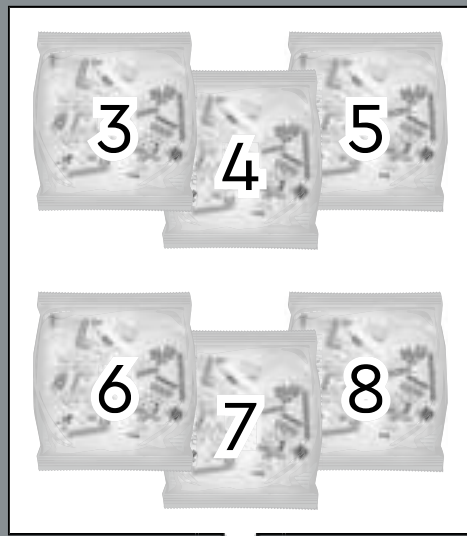
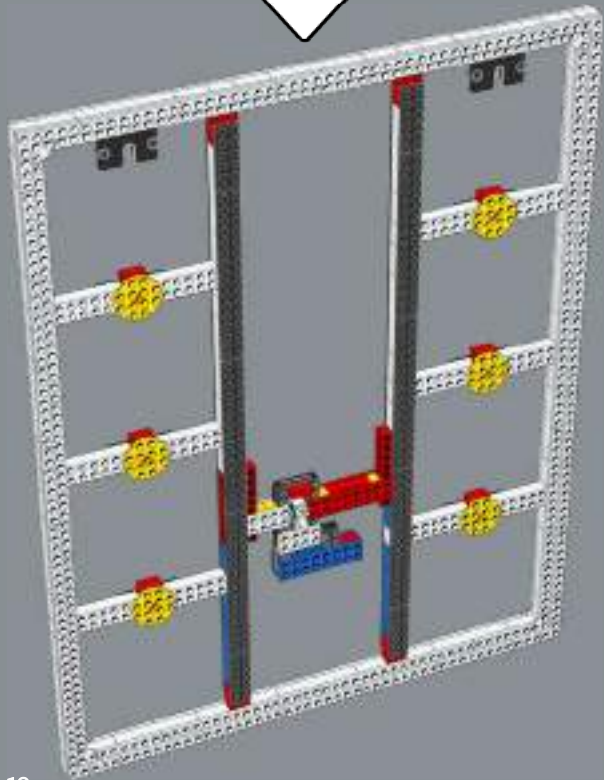
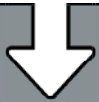

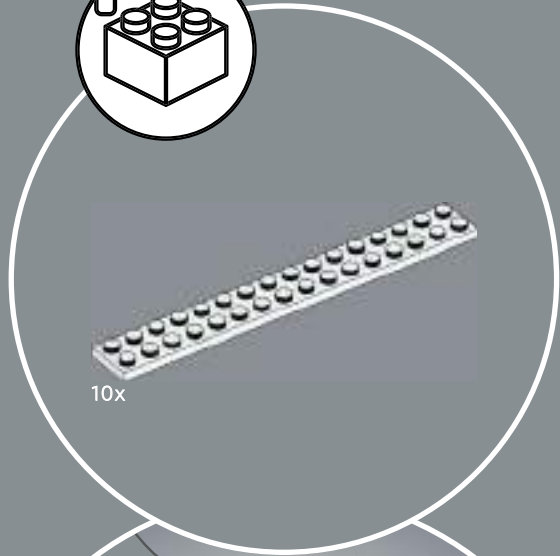
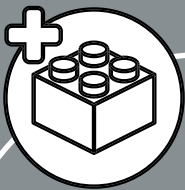

10x

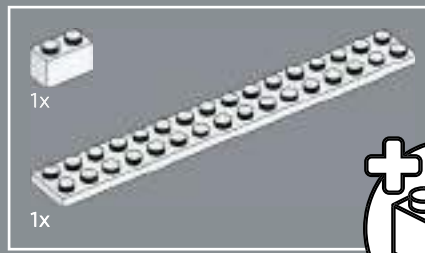

1x

1x

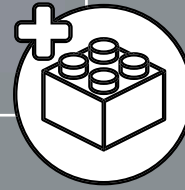

1

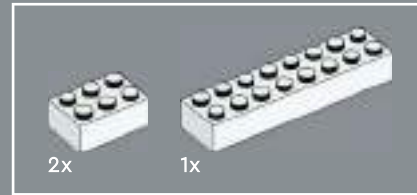
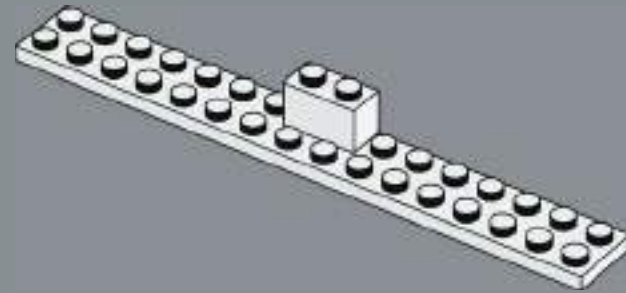

2x

1x

2

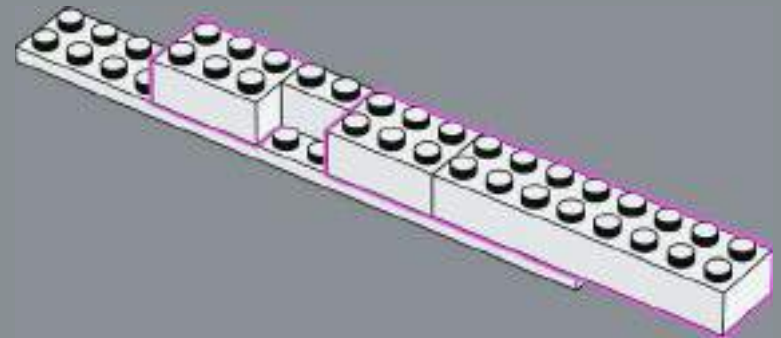

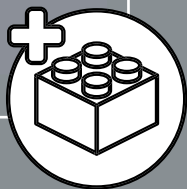
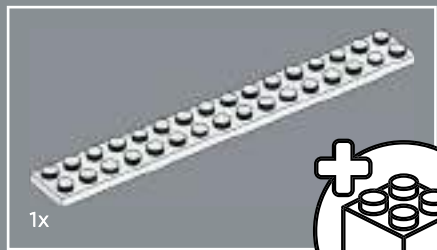

3

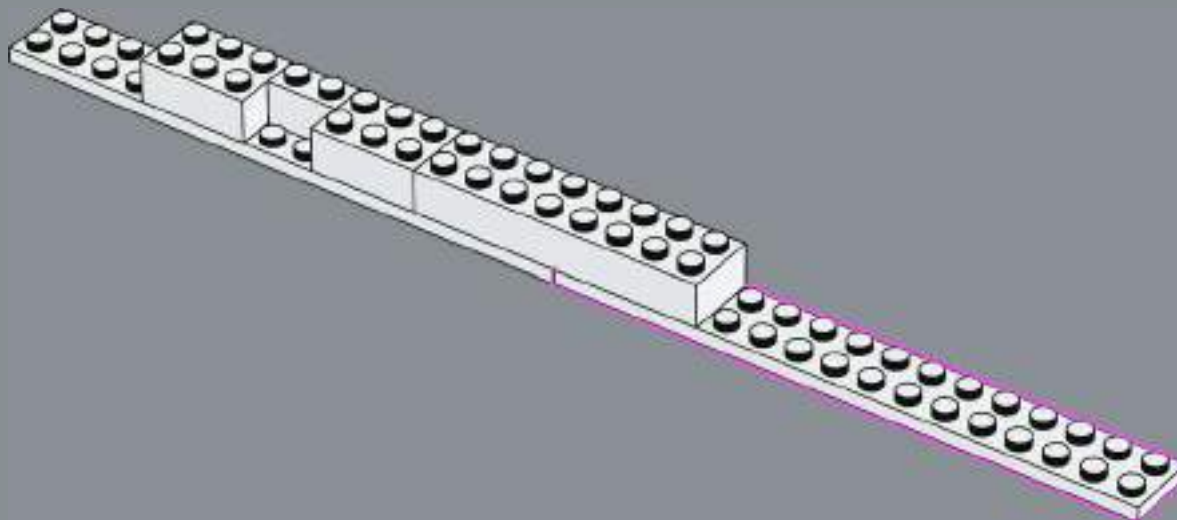

4

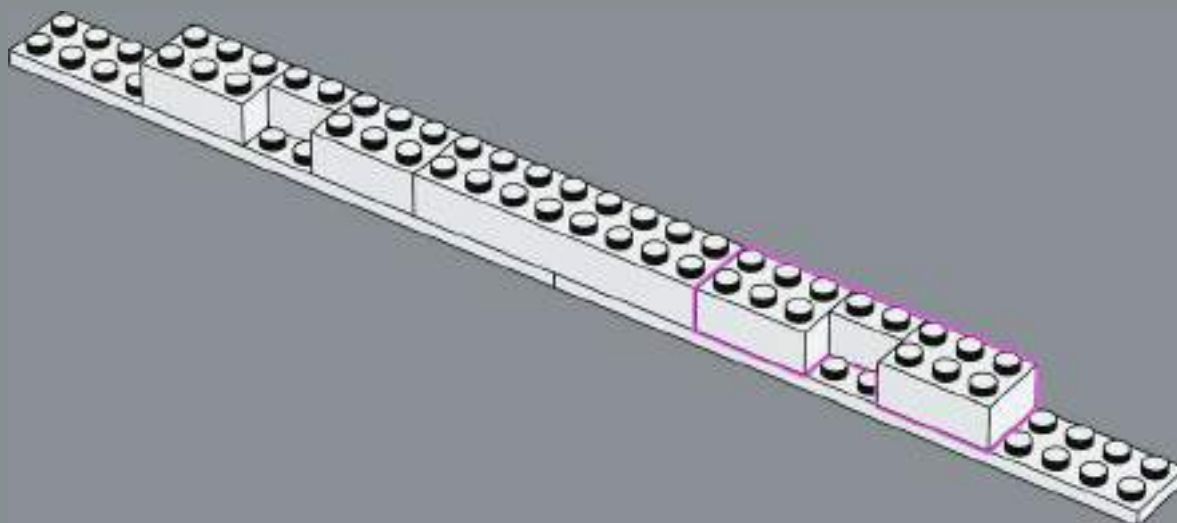

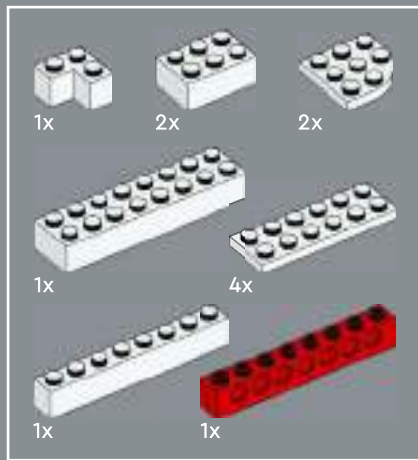

5

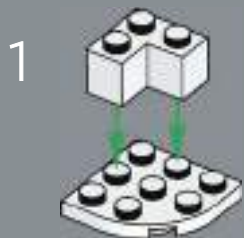

2

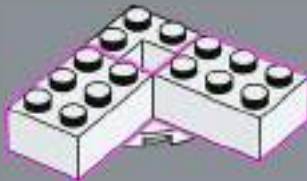

3

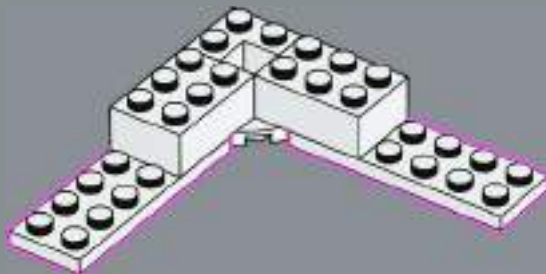

4

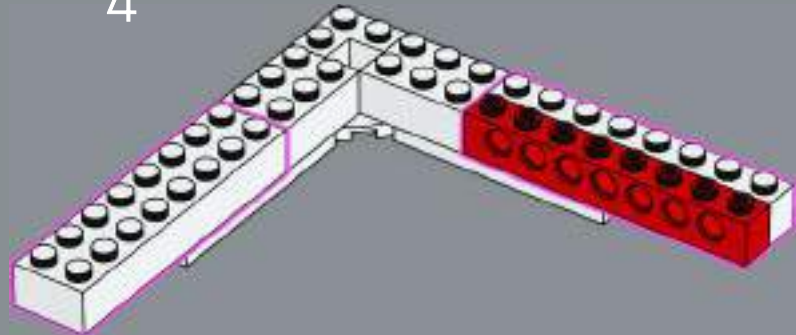

5

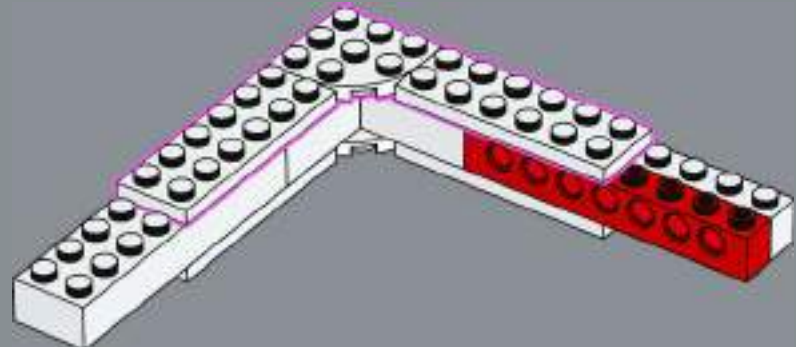

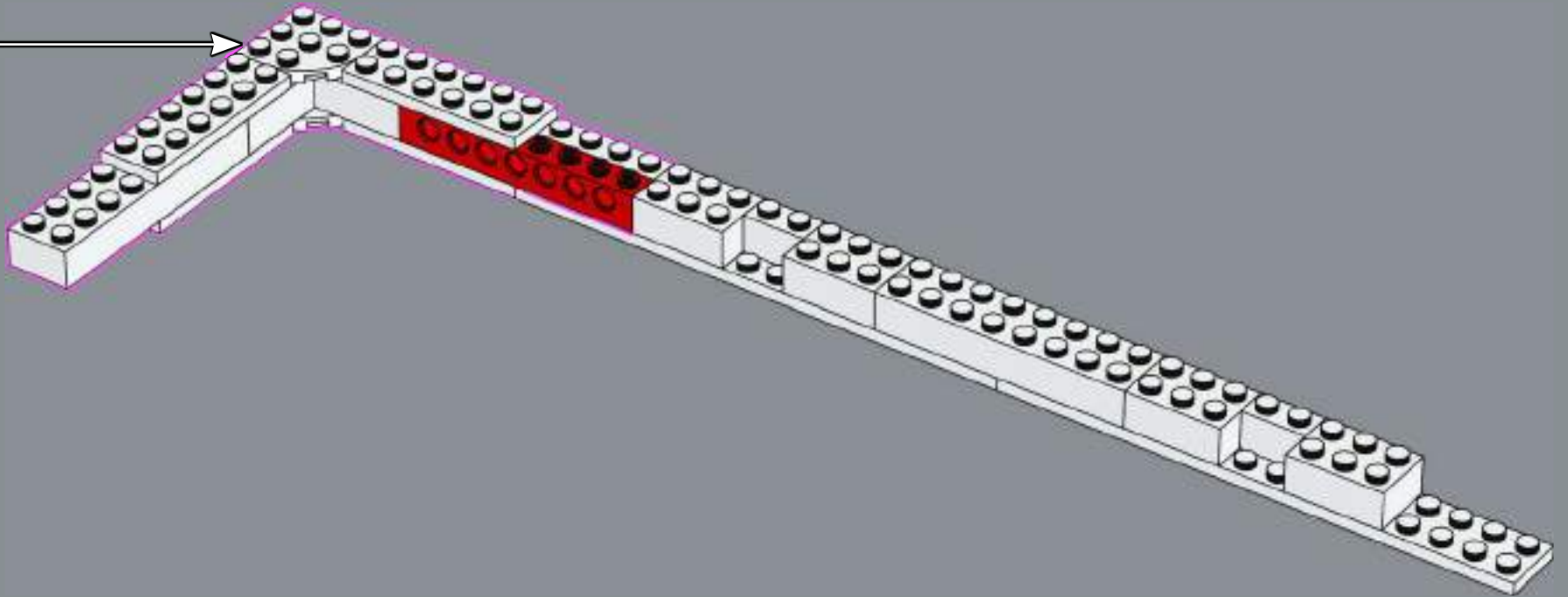

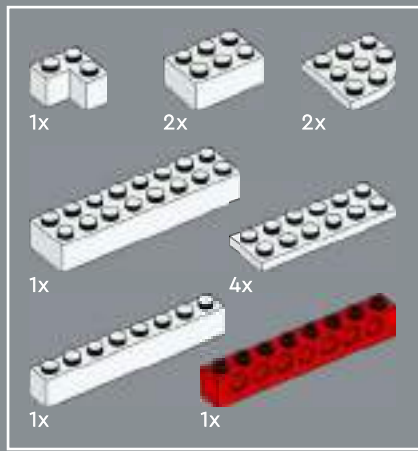

6

1

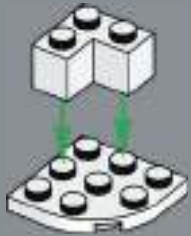

2

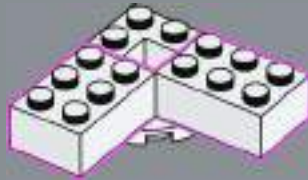

3

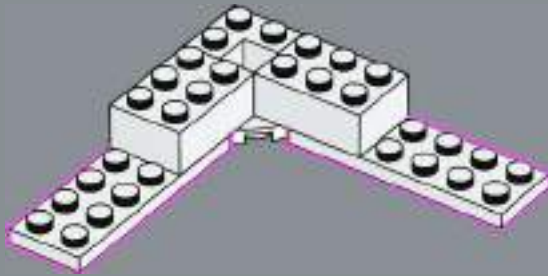

4

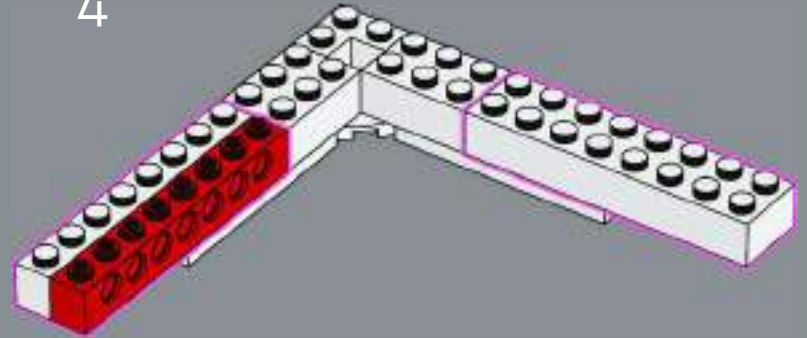

5

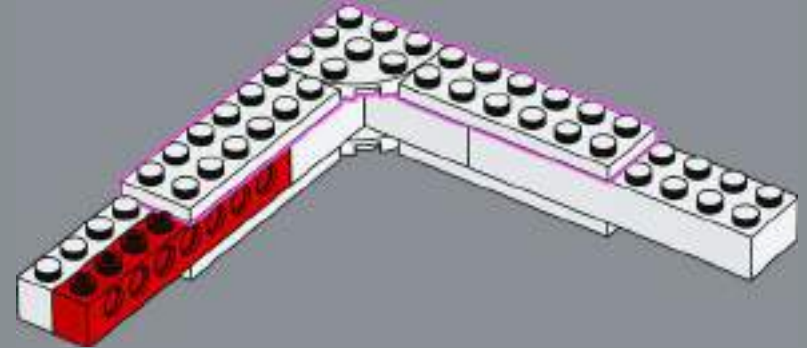

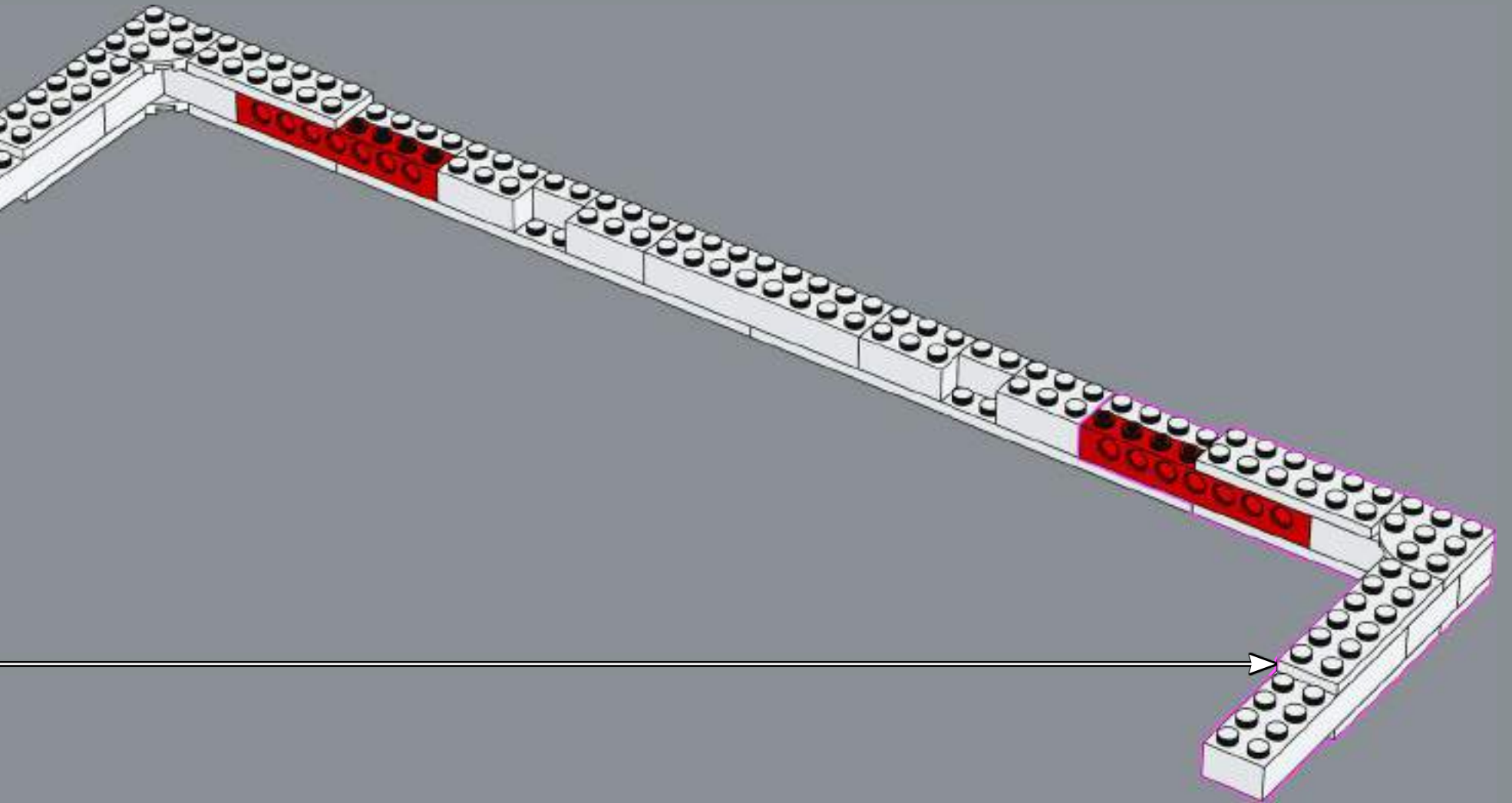



7

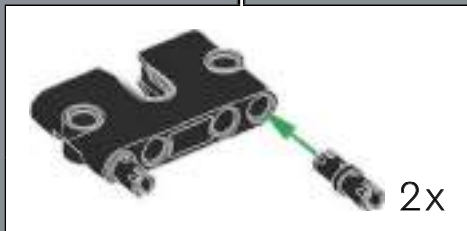
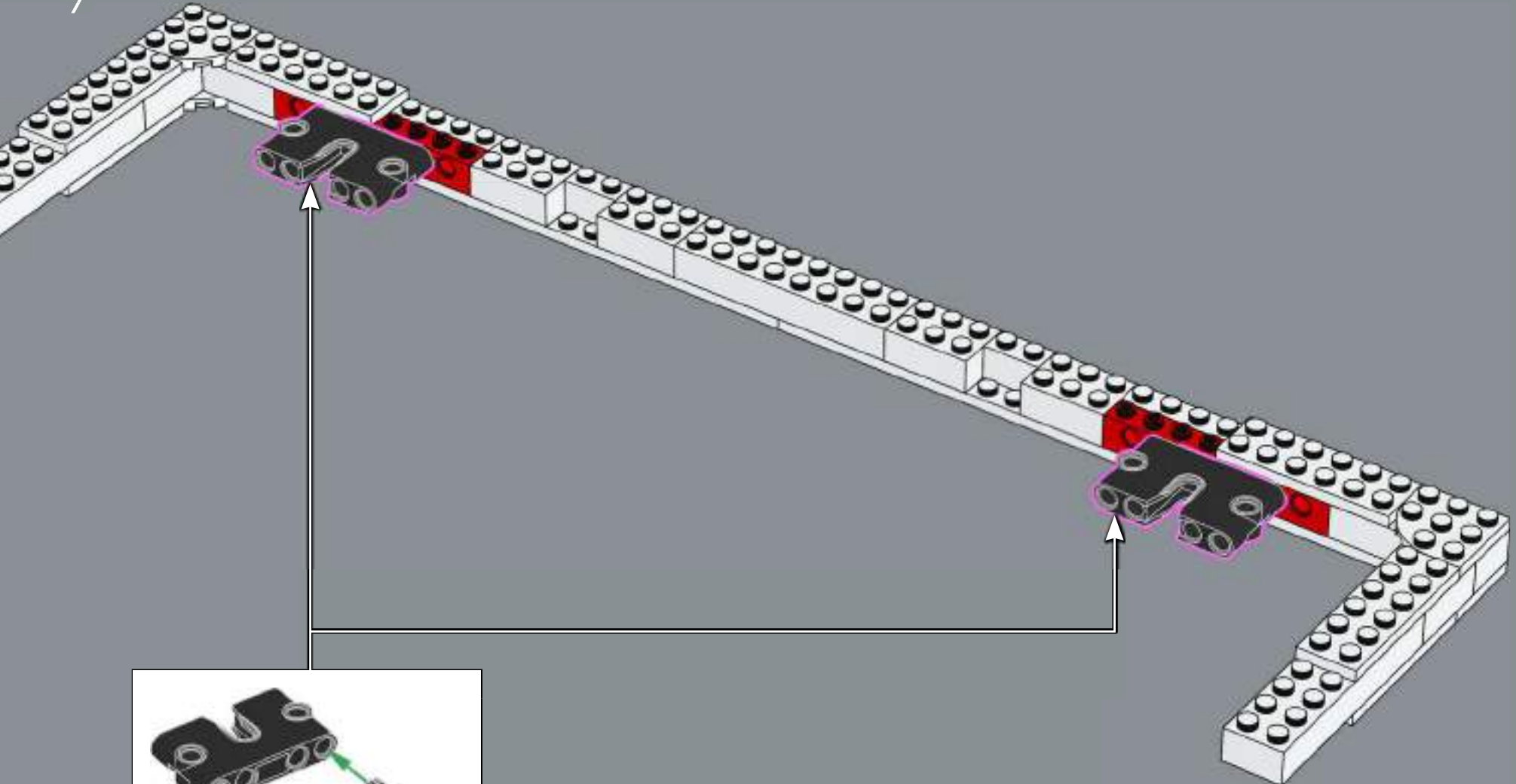

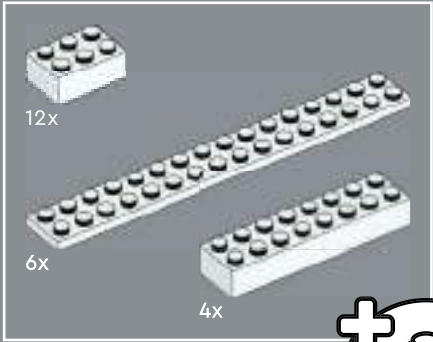
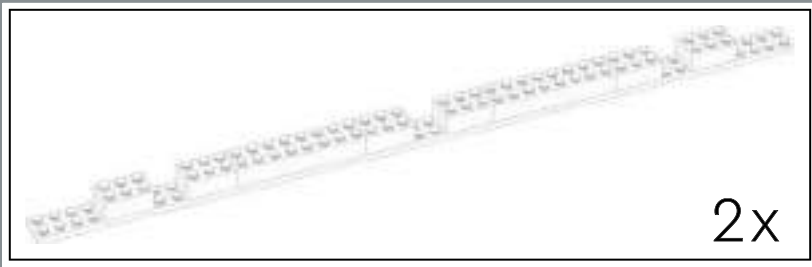

8

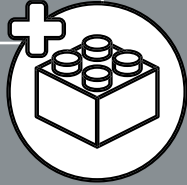

1

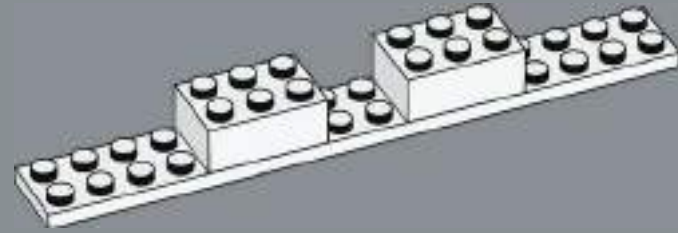

2

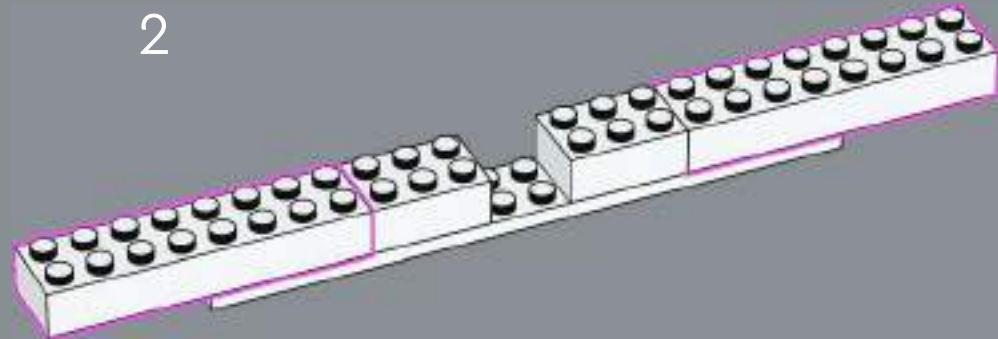

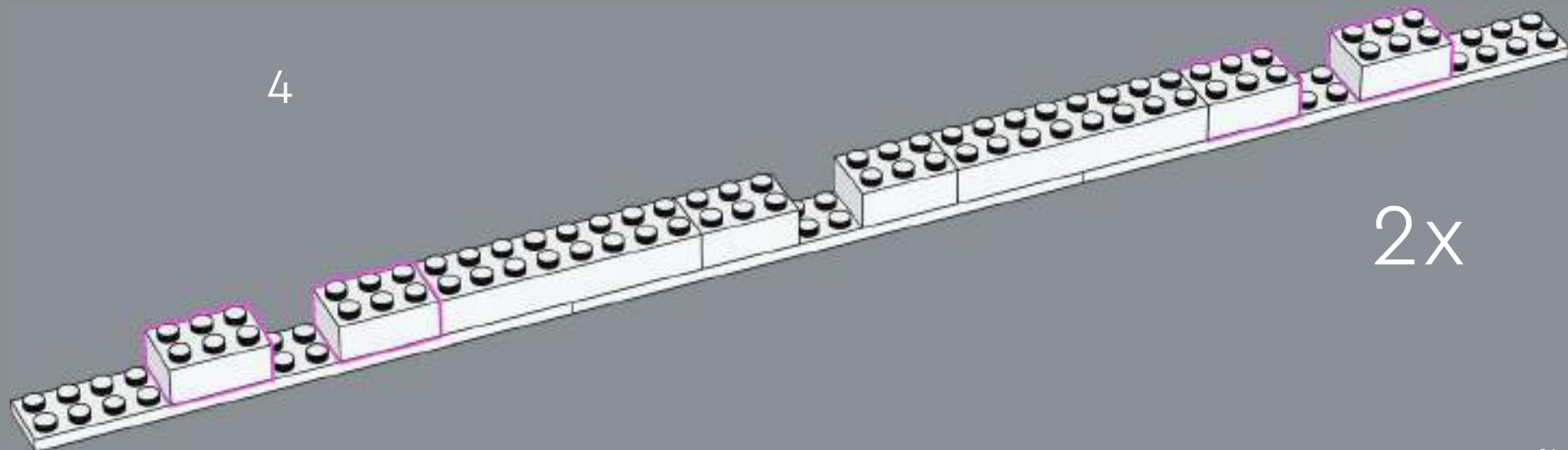
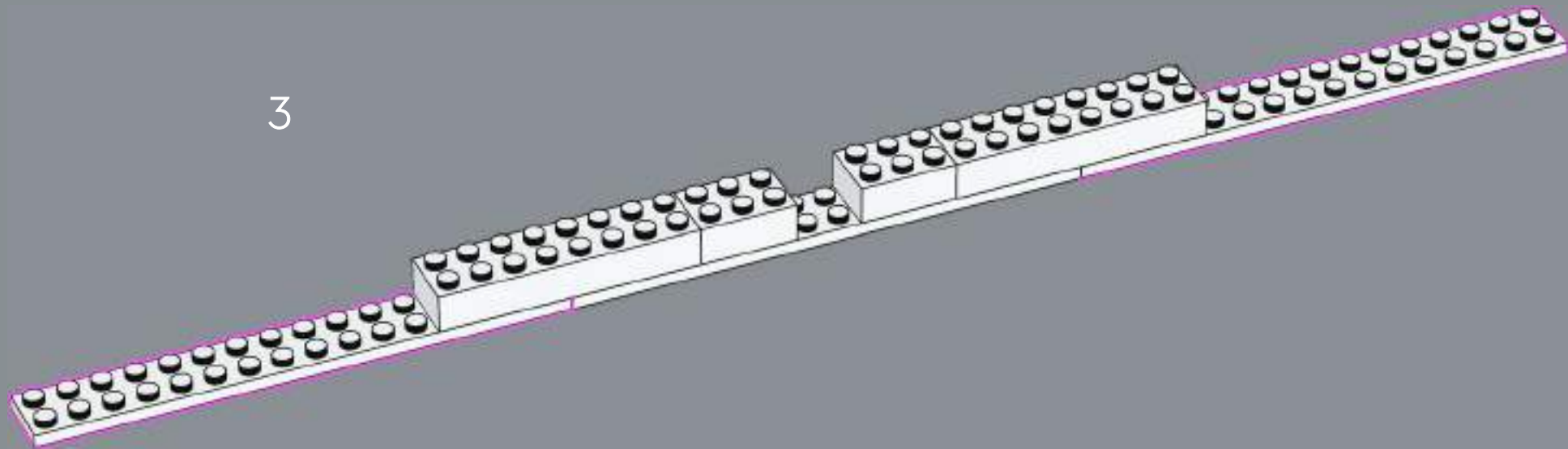

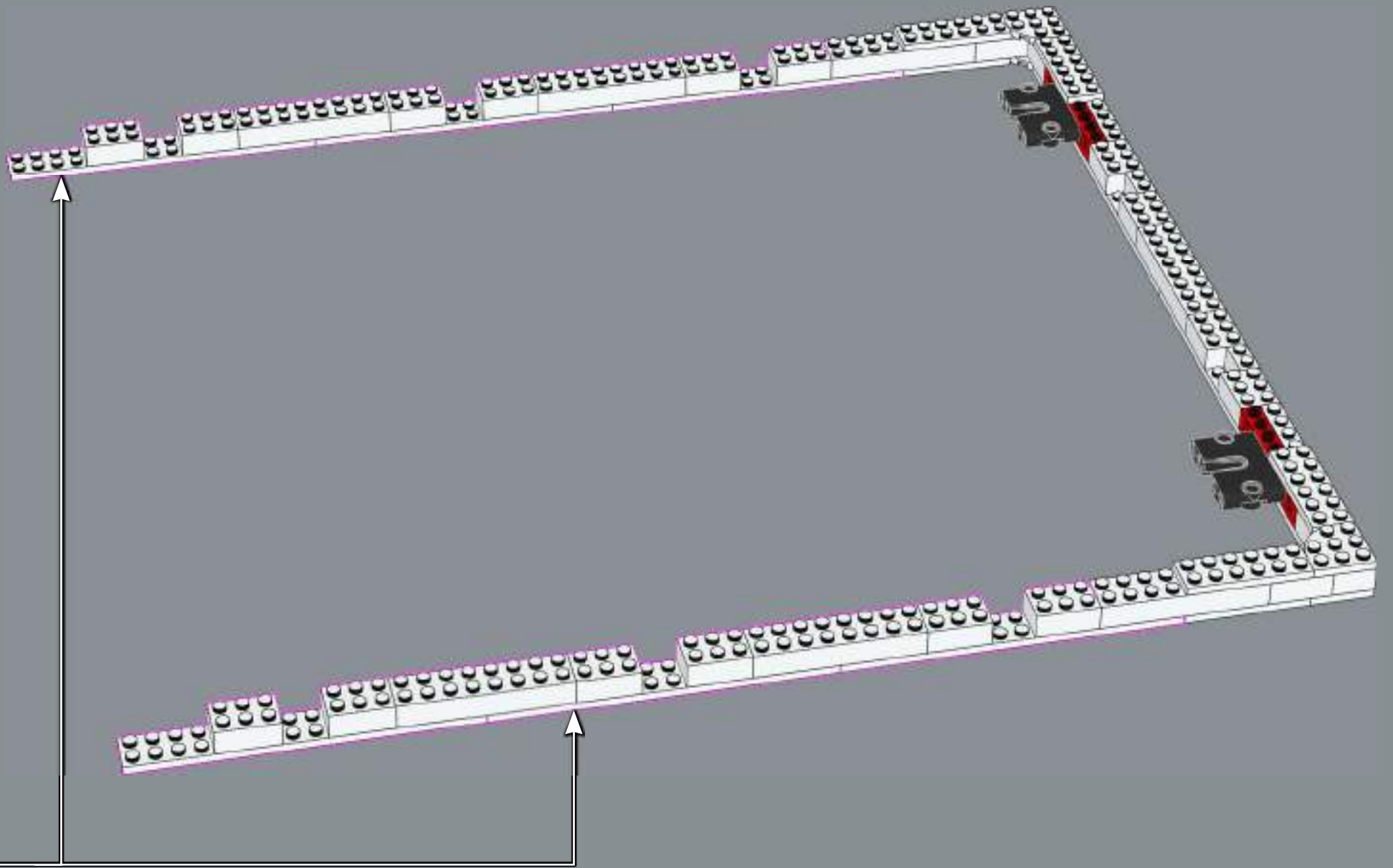

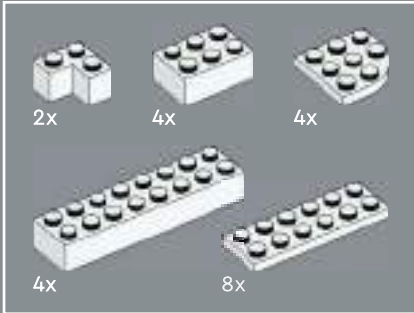
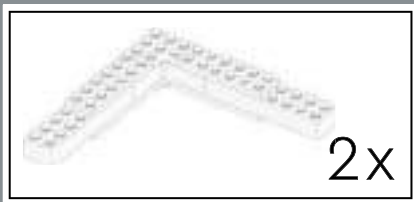

9

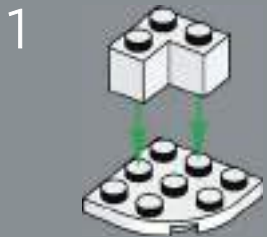

2

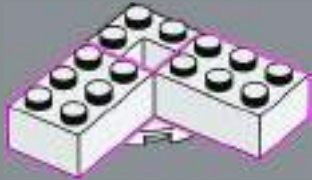

3

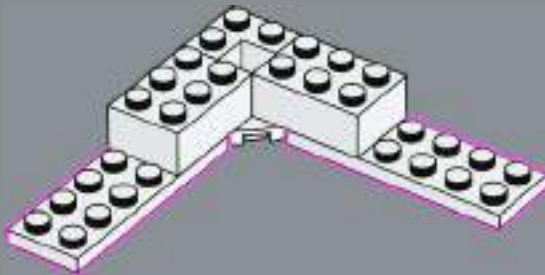

4

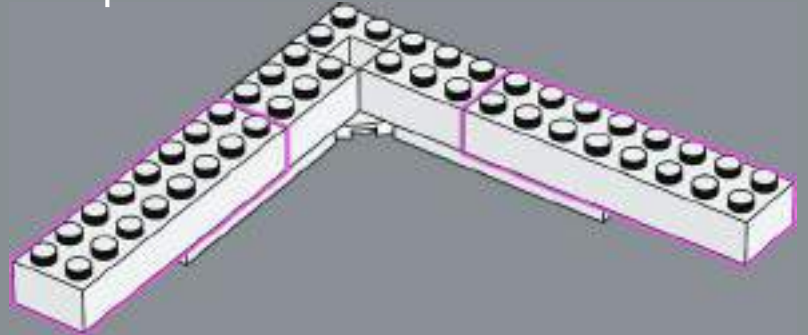

5

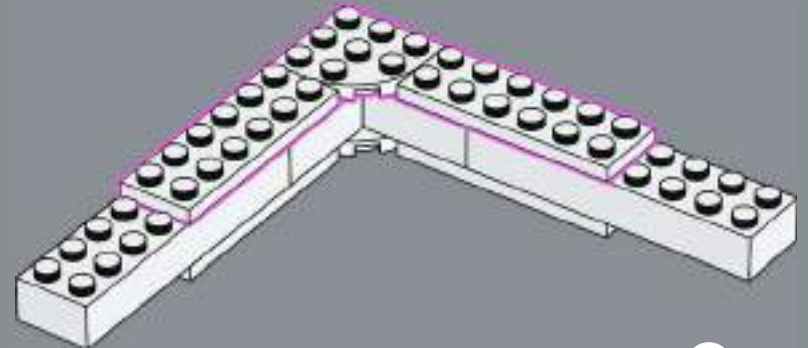

2x

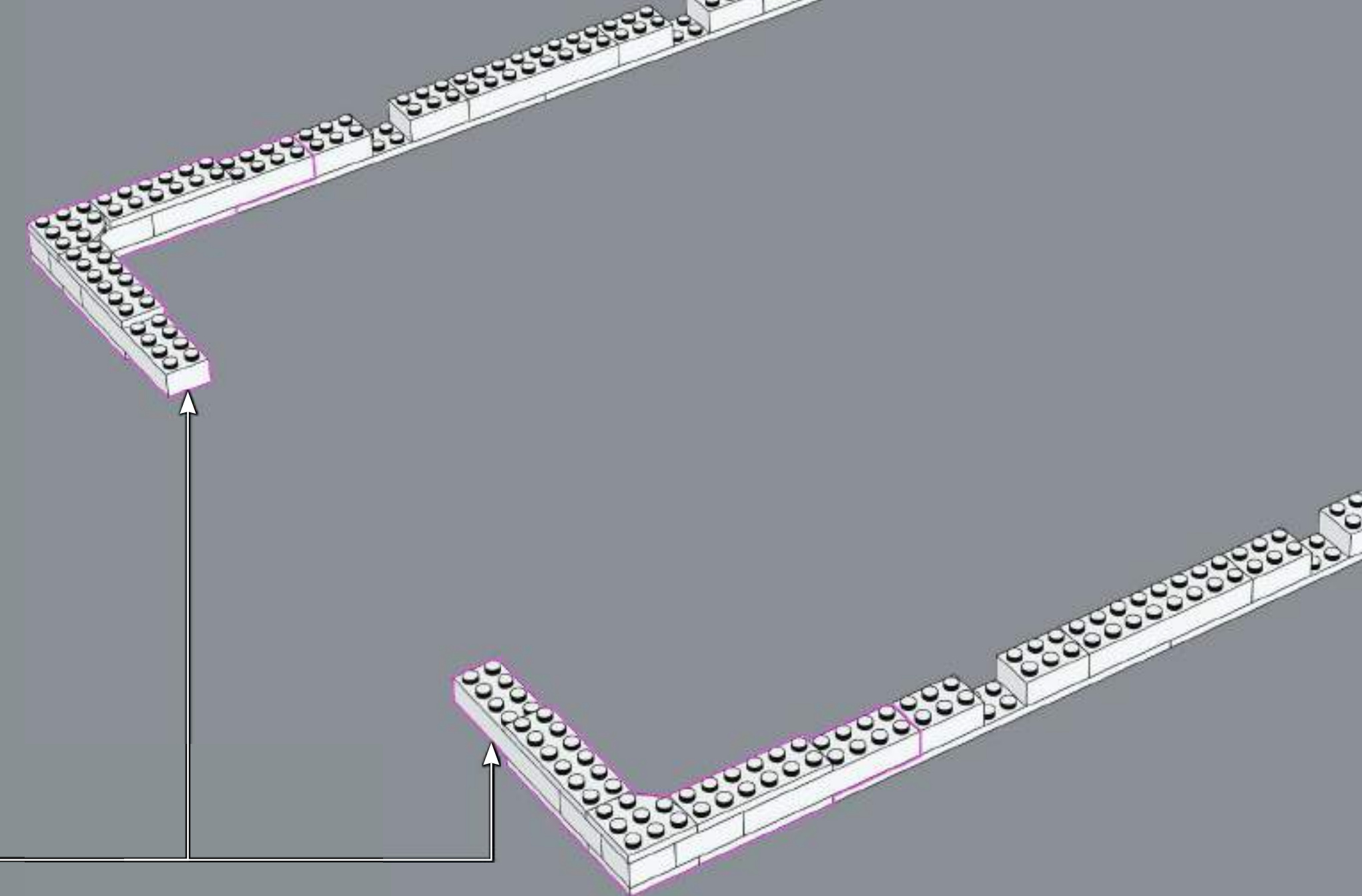

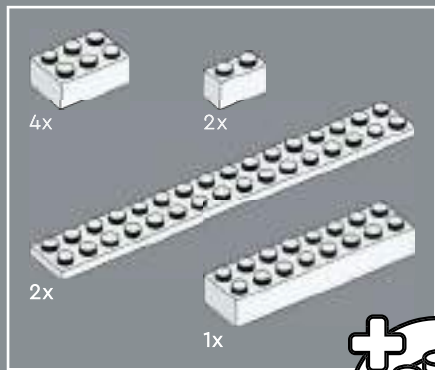

10

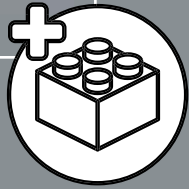

1

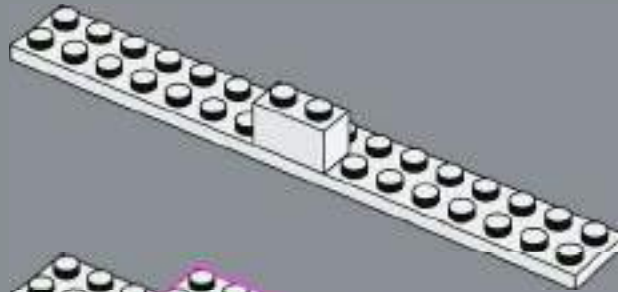

2

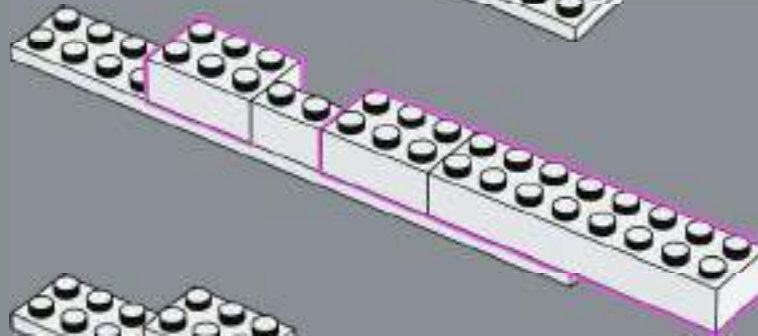

3

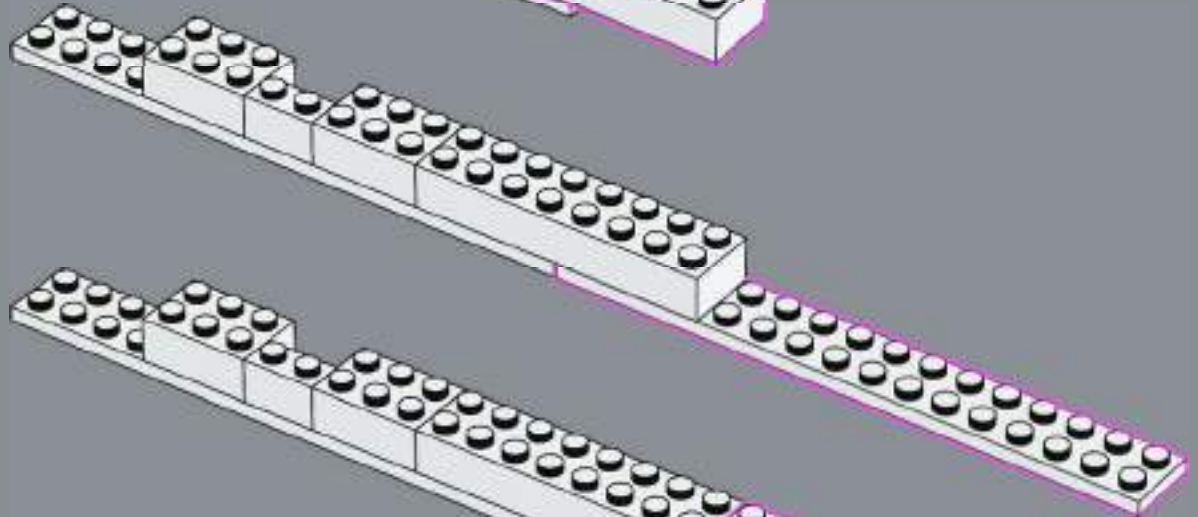

4

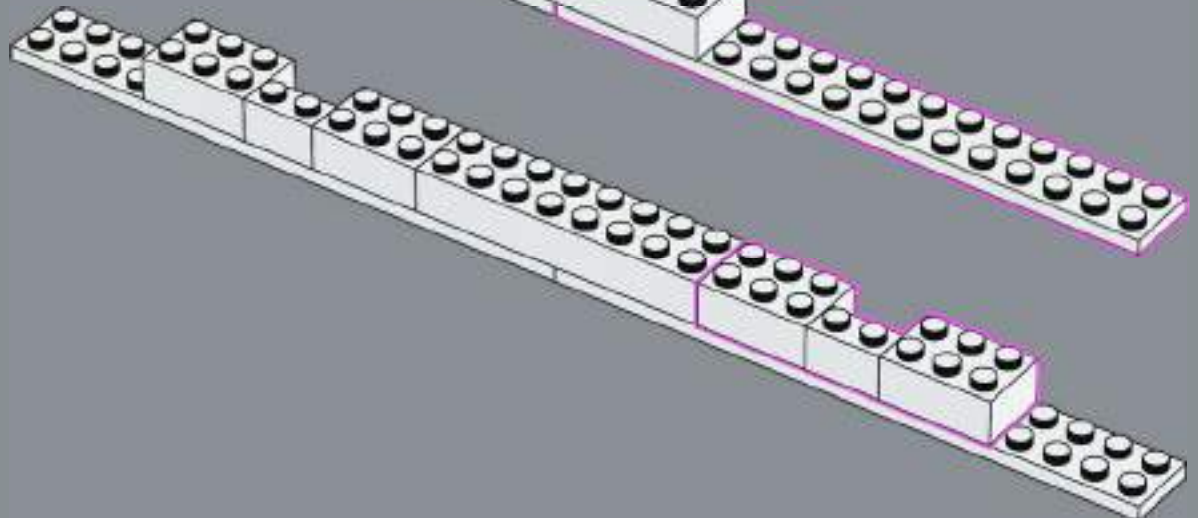

Every comic starts with a frame ...
A comic panel consists of a single
image depicting a frozen moment.
The blank space separating the
panels (a "gutter") creates a
transition between moments in
the story.

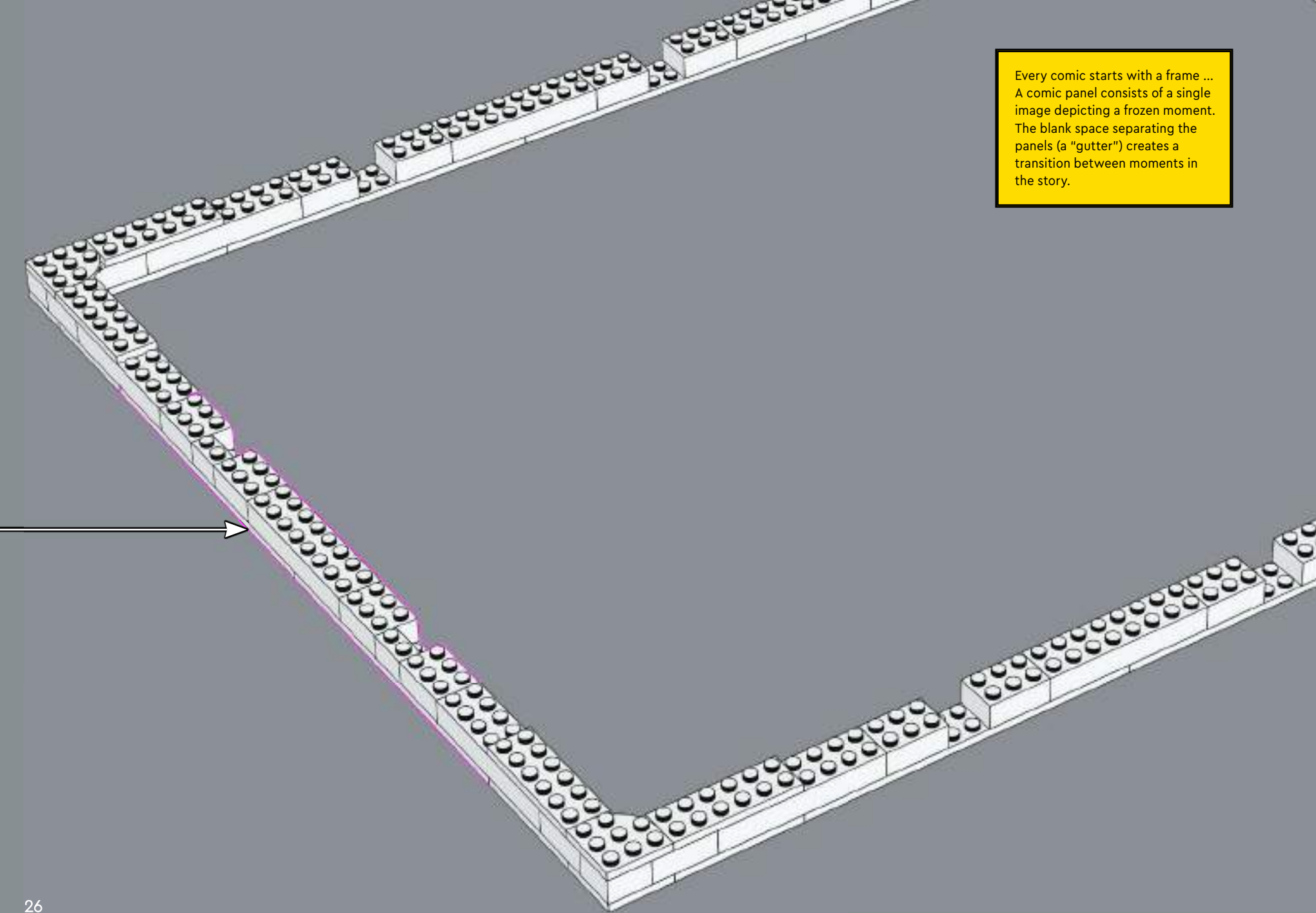

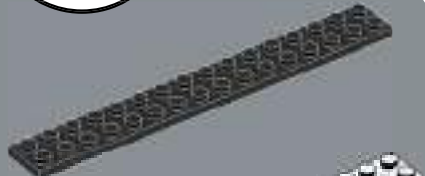
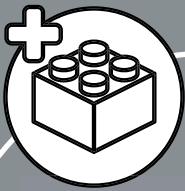

12x

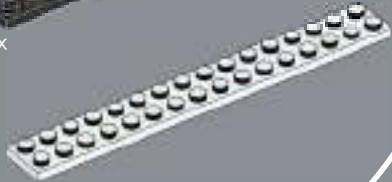

10x

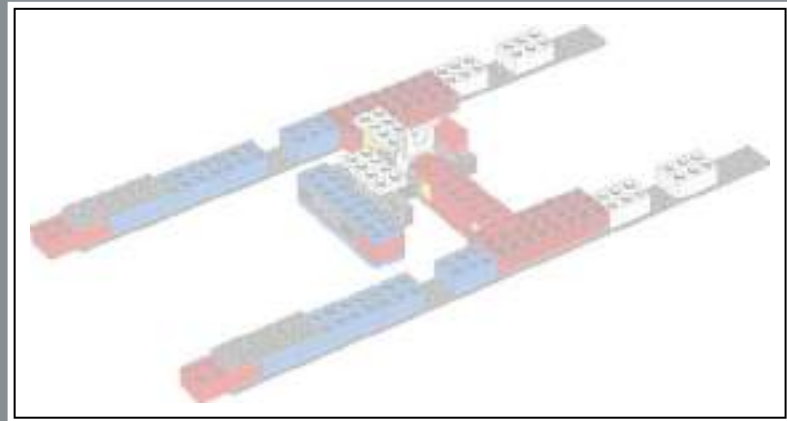

1x



1x

11



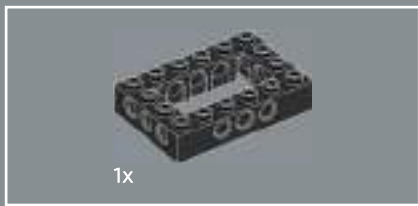

12

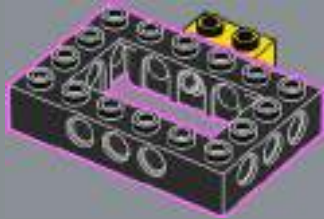

13

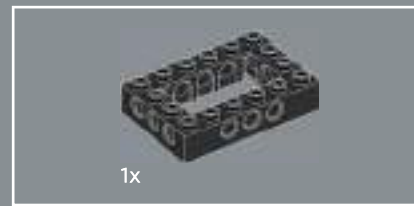

14

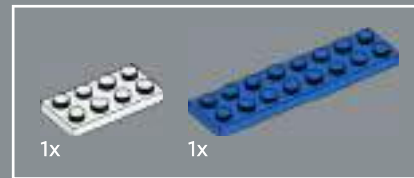
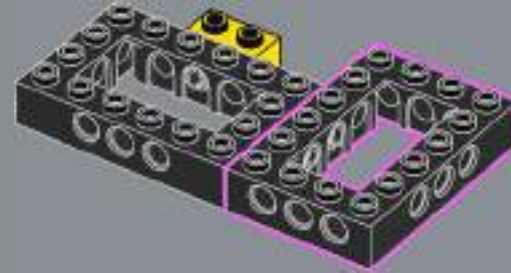

15

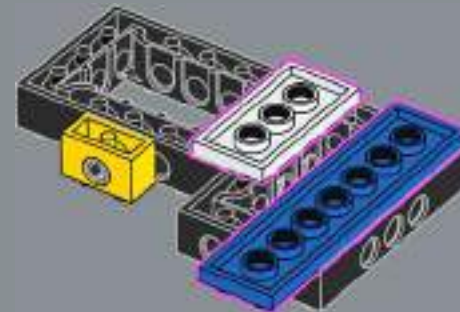

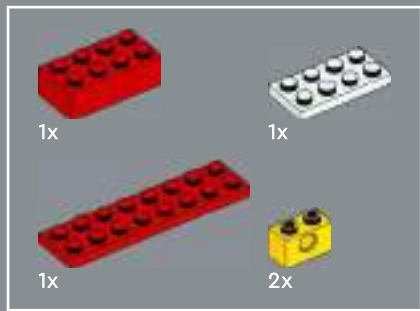

16

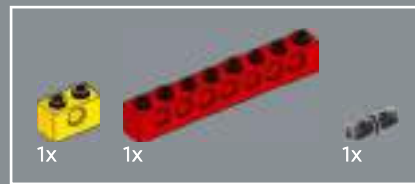
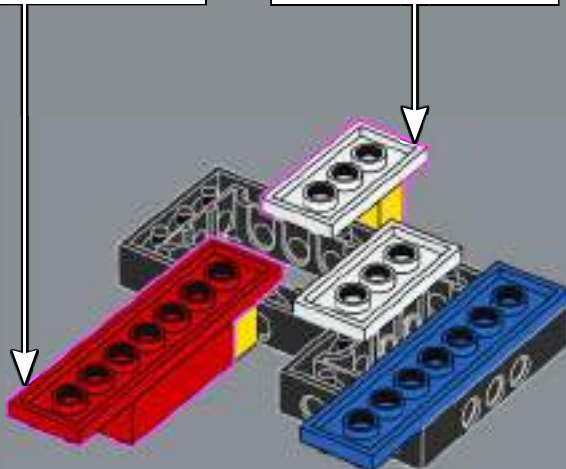
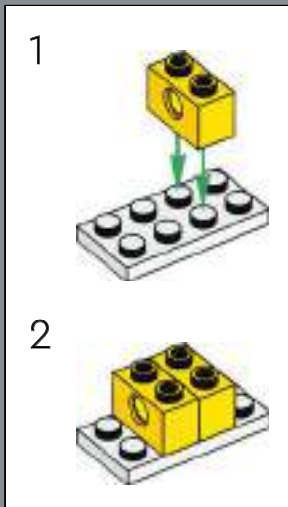
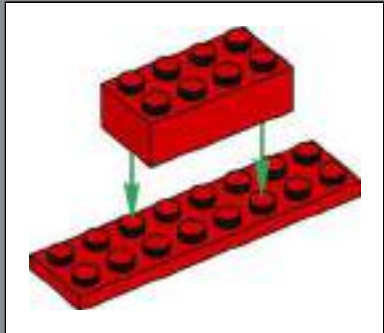

17

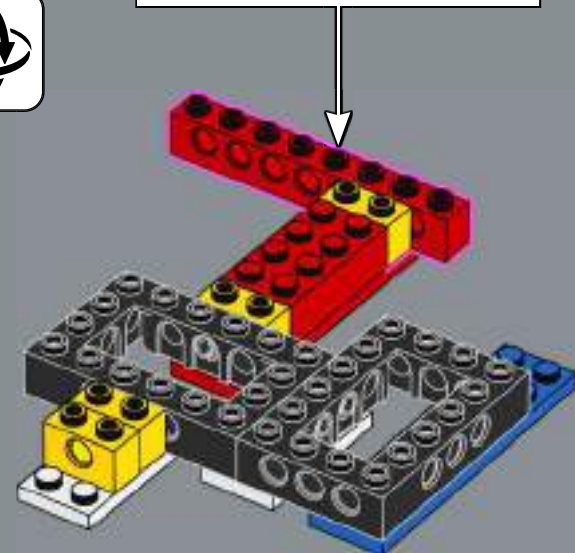
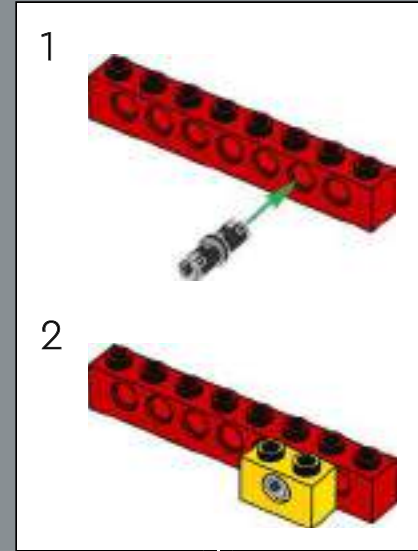

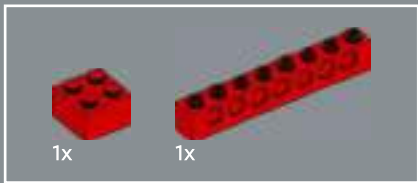

18

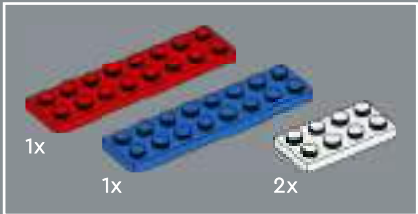
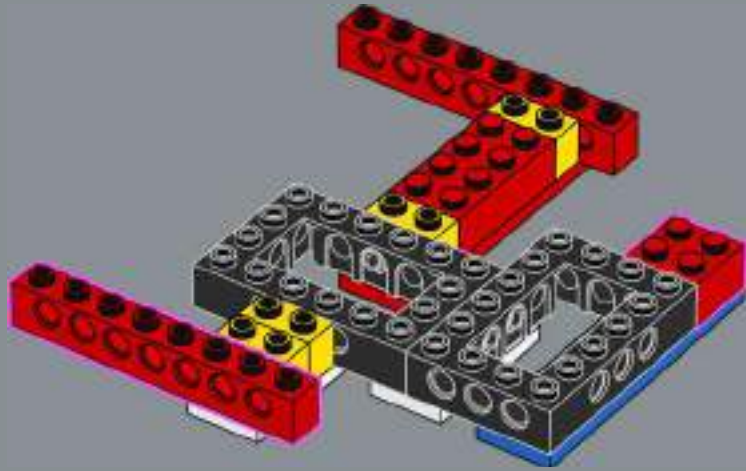

19

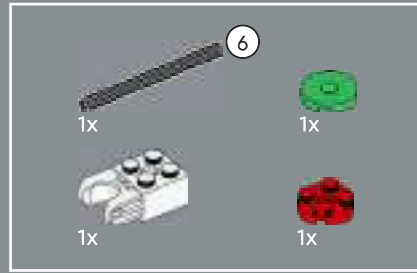
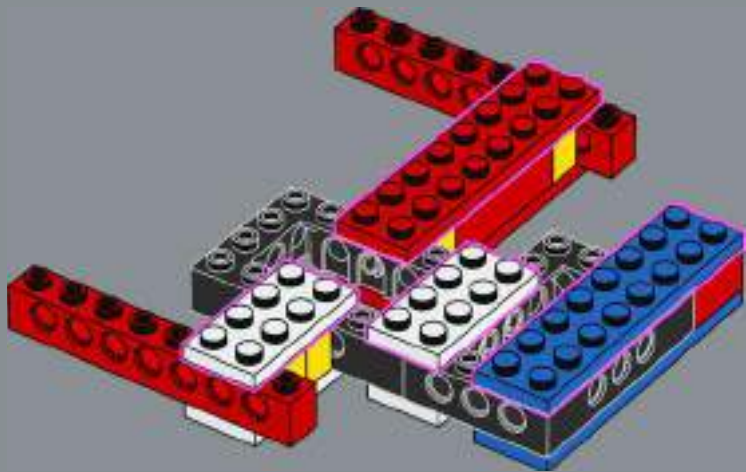

20

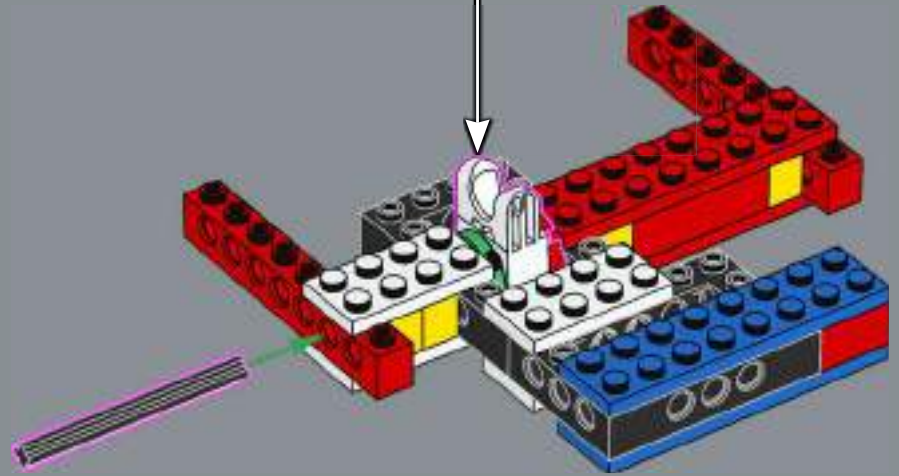

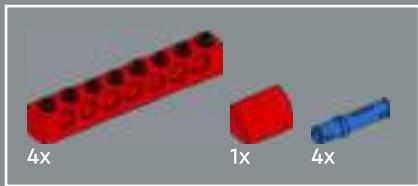

21

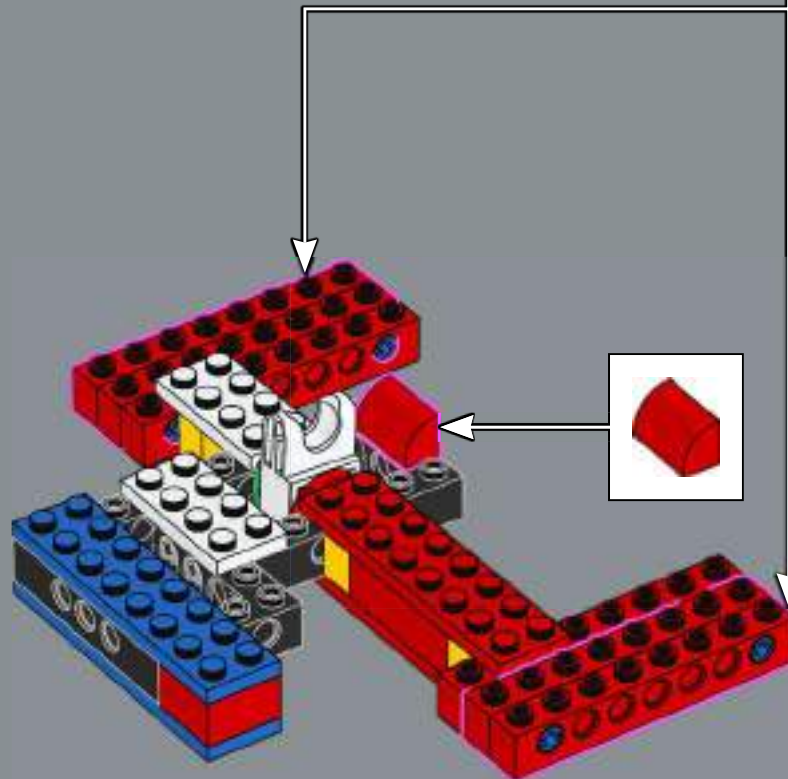
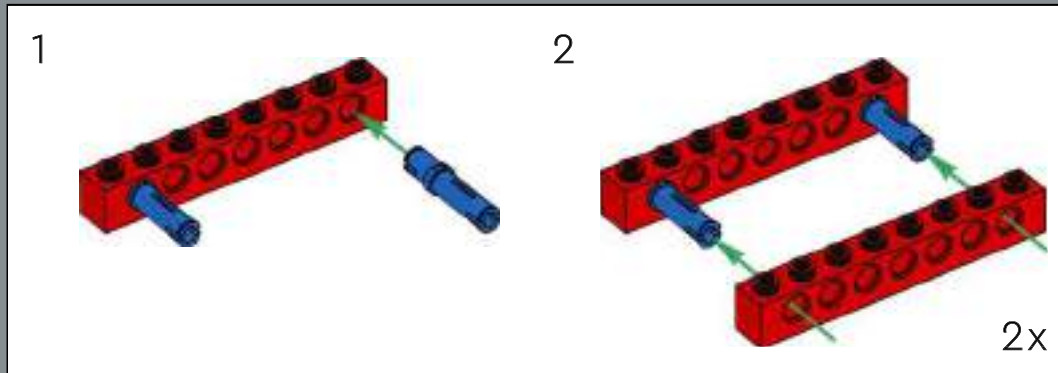

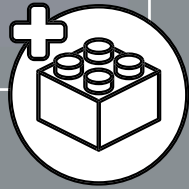
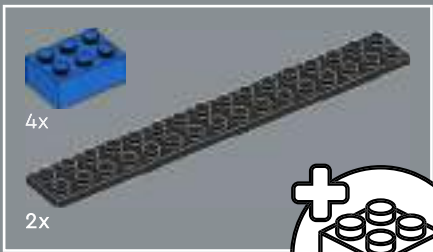

22

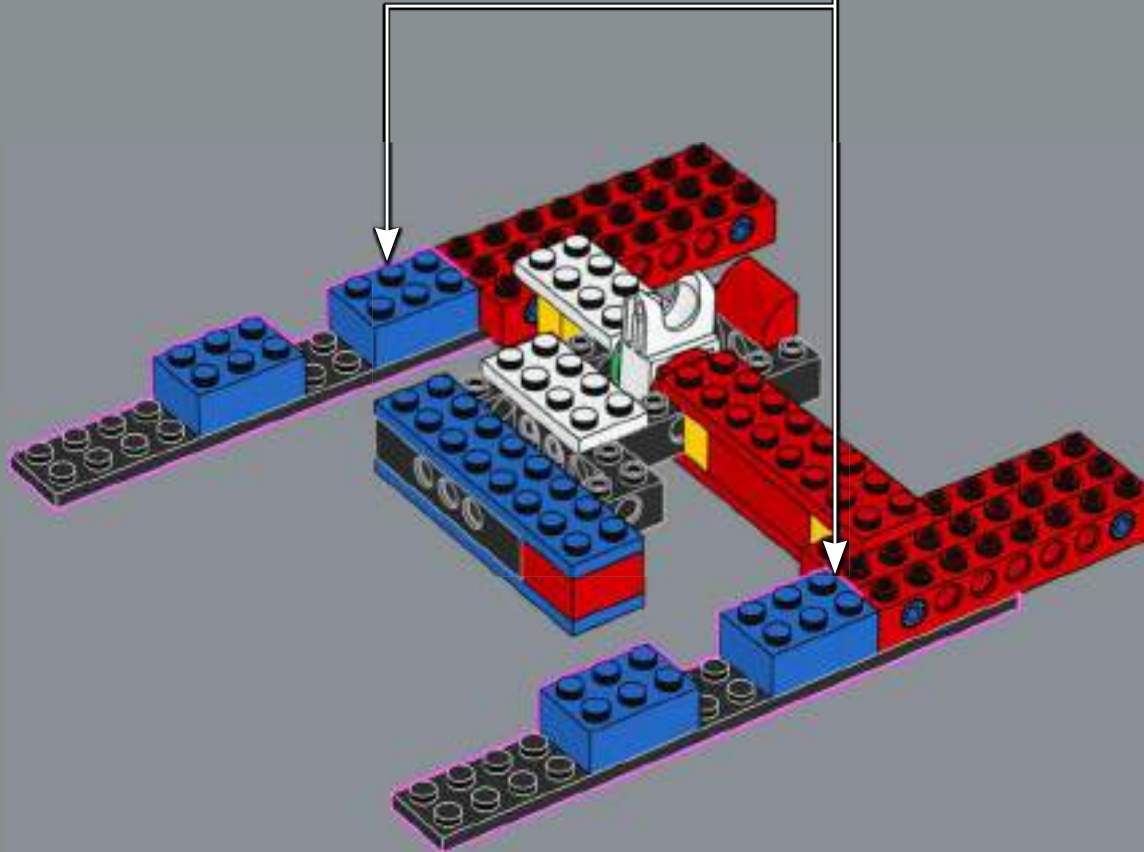
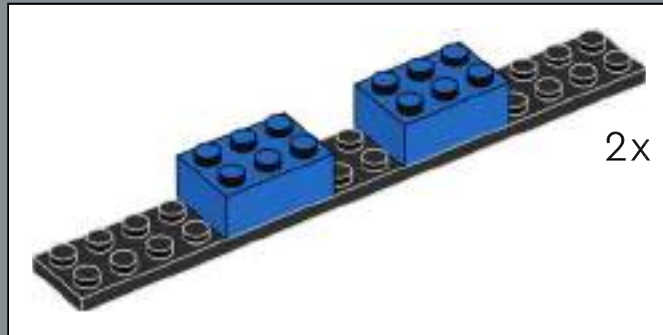

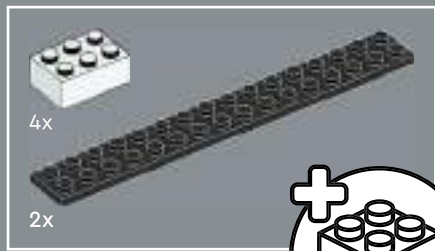

23

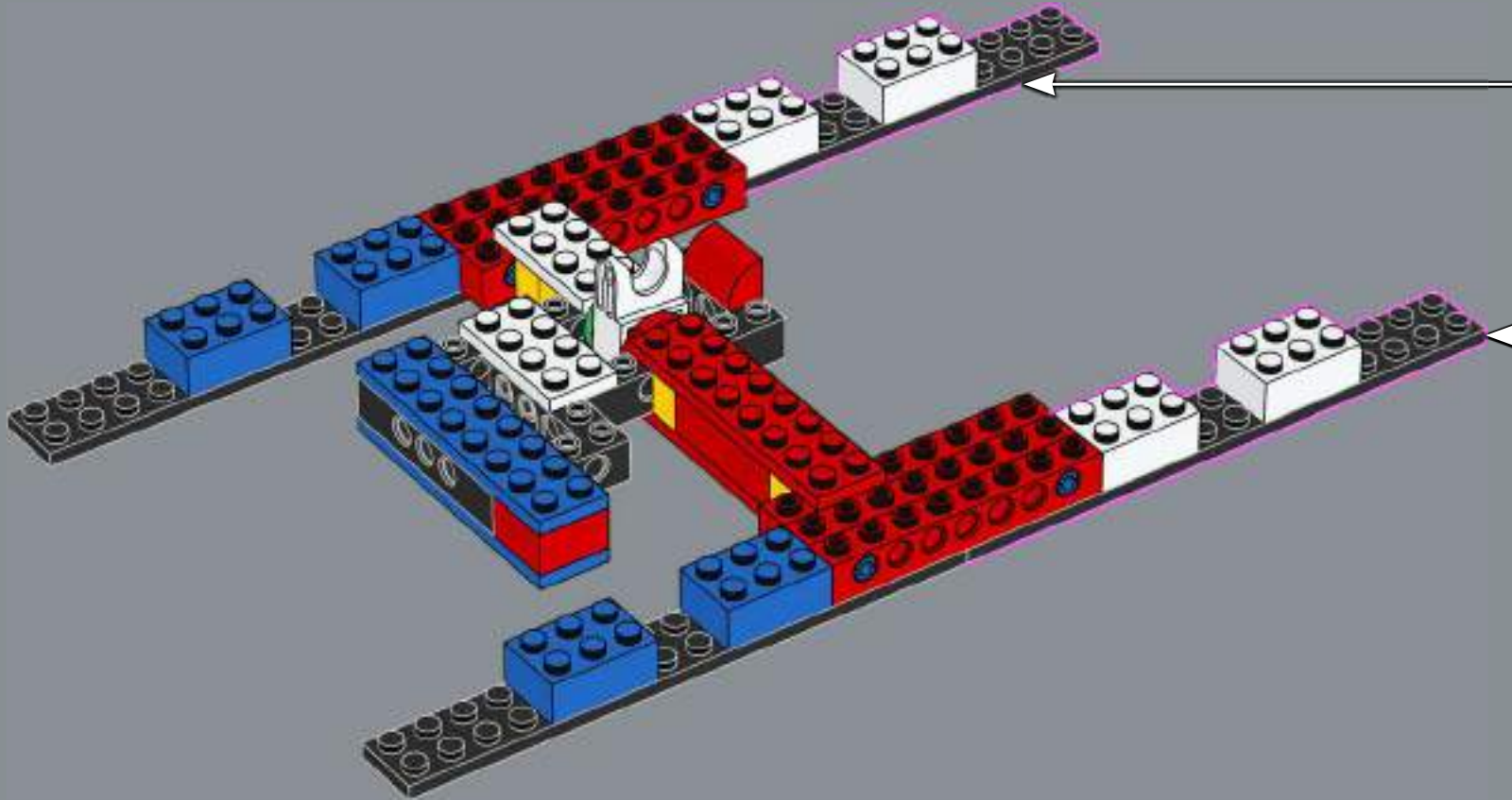
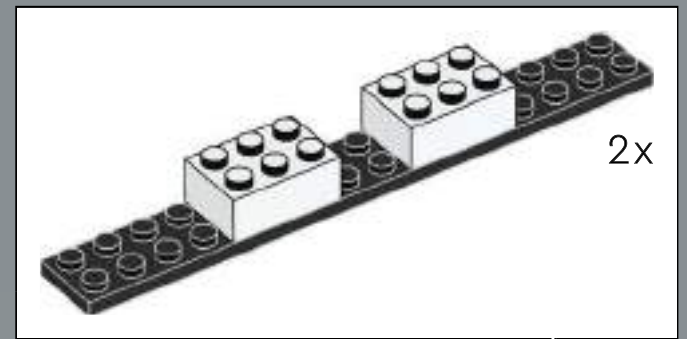
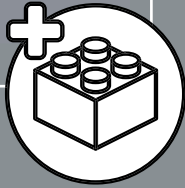

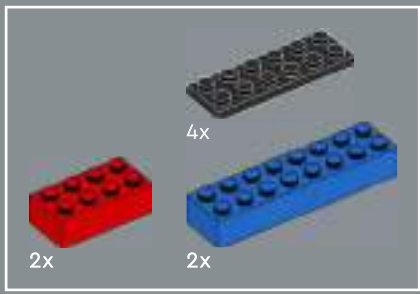

24

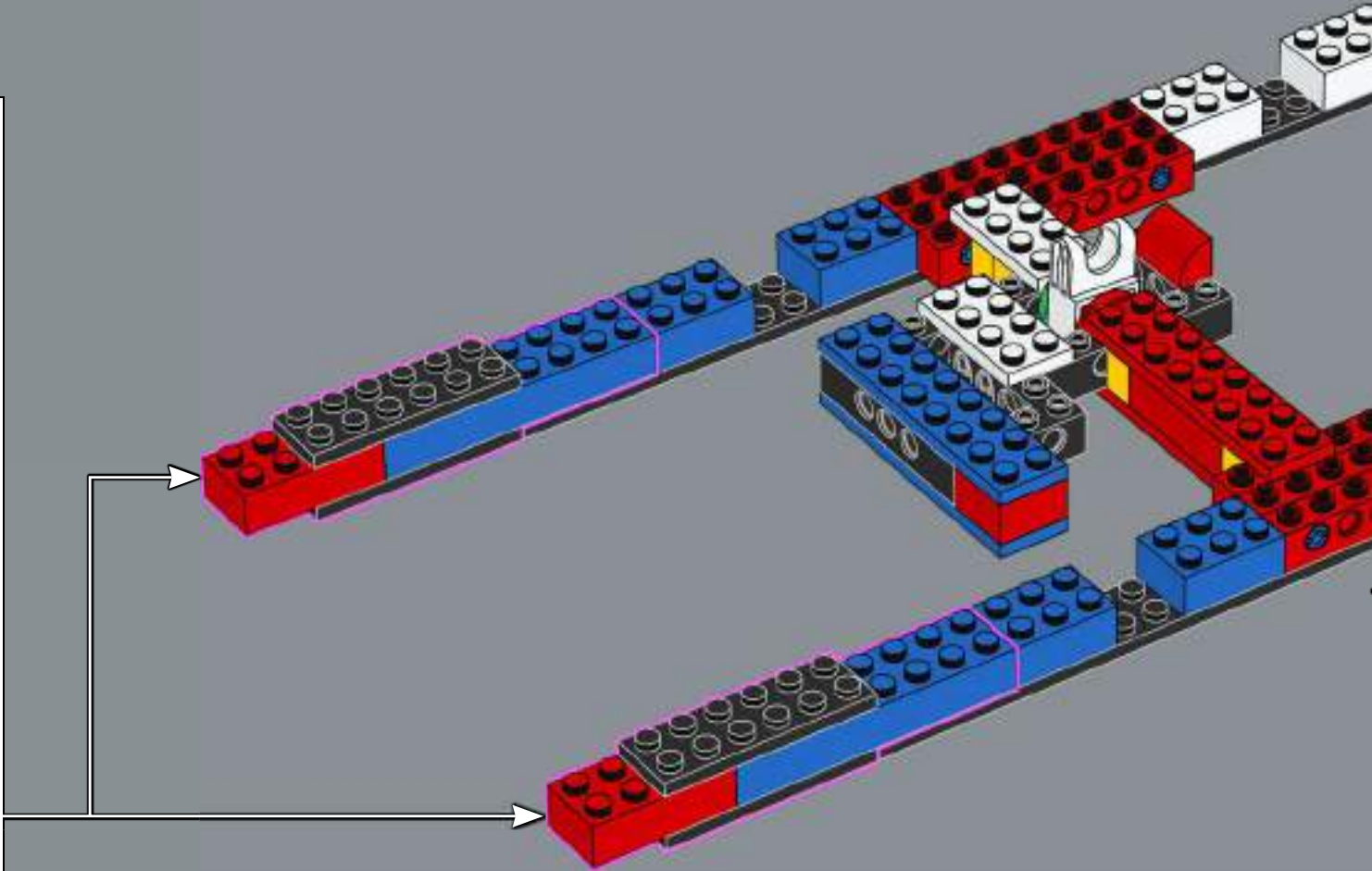
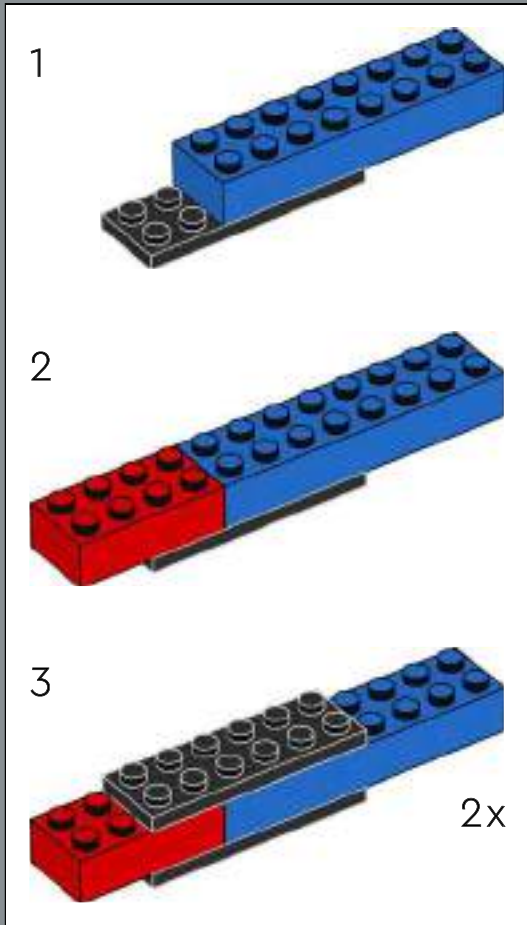

25

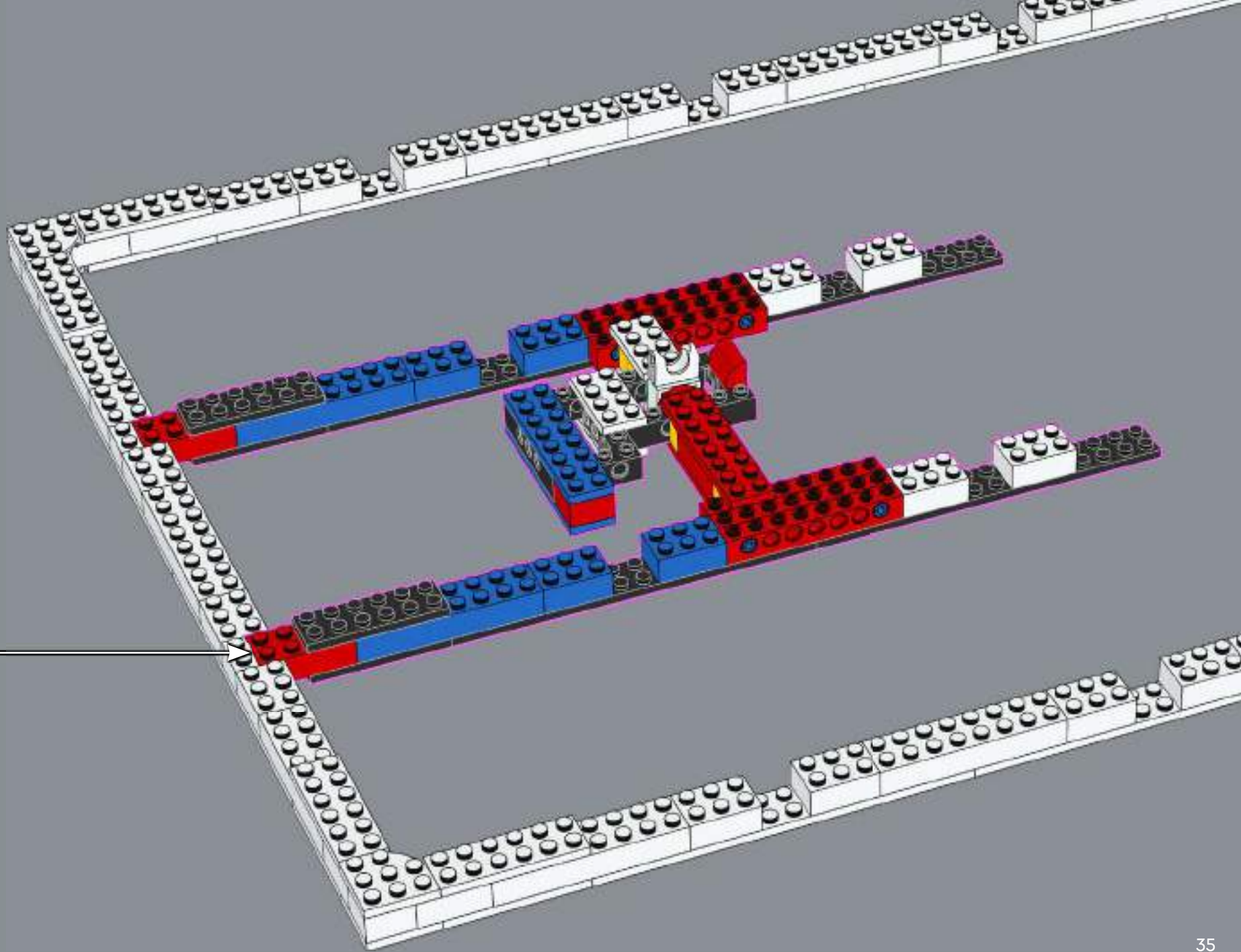

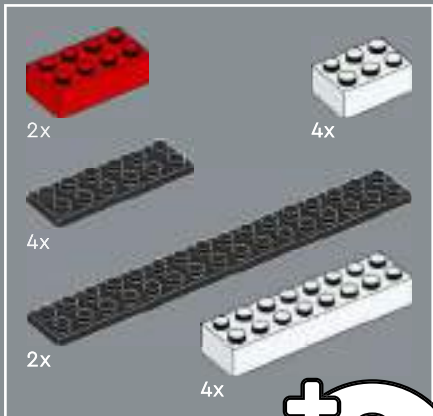
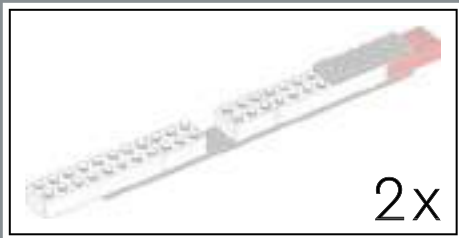

26

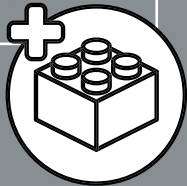

1

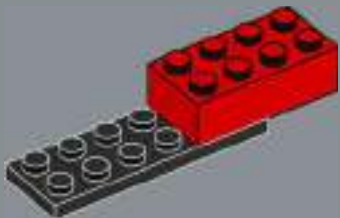

2

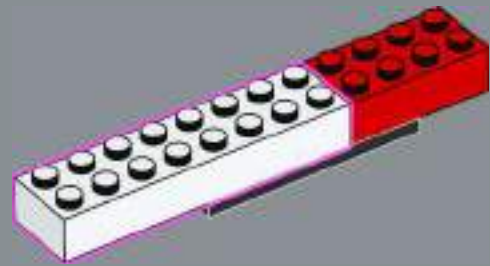

3

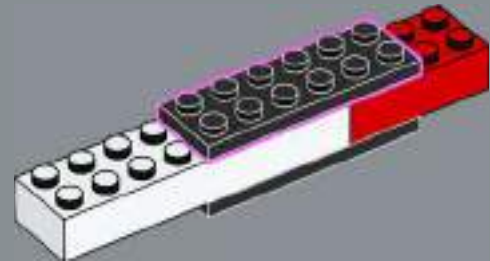

4

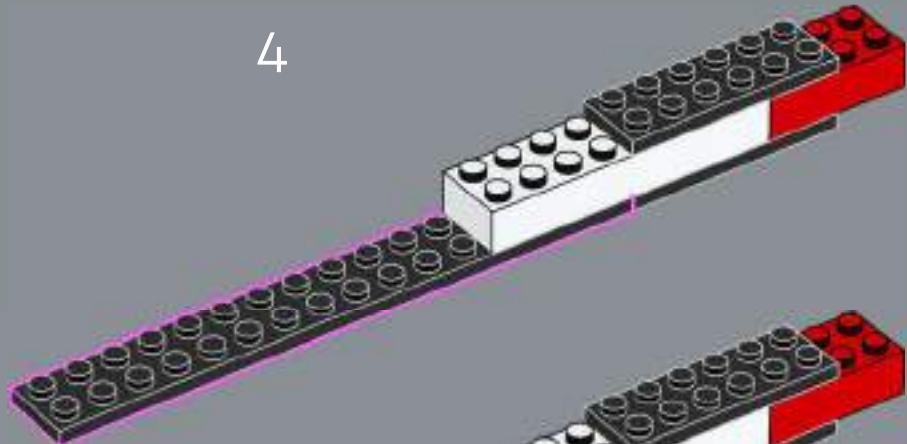

5

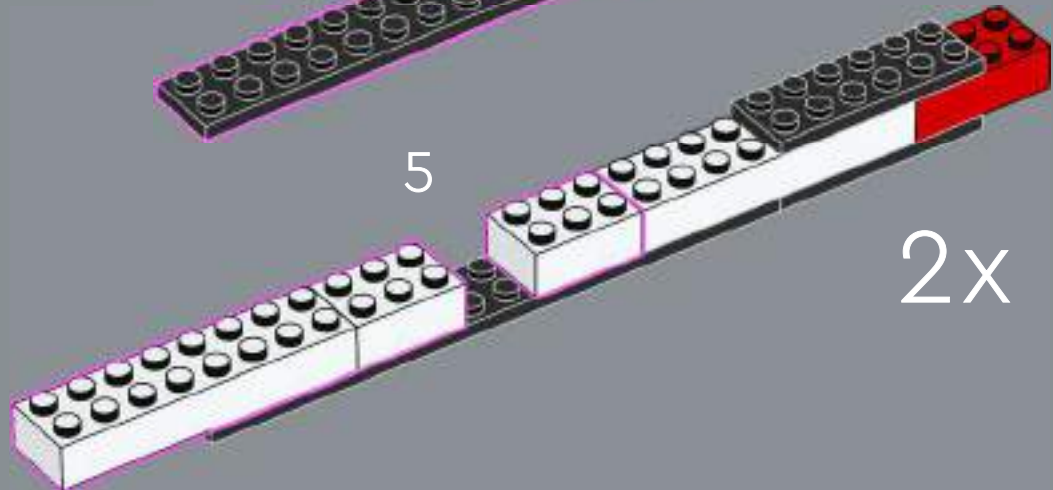

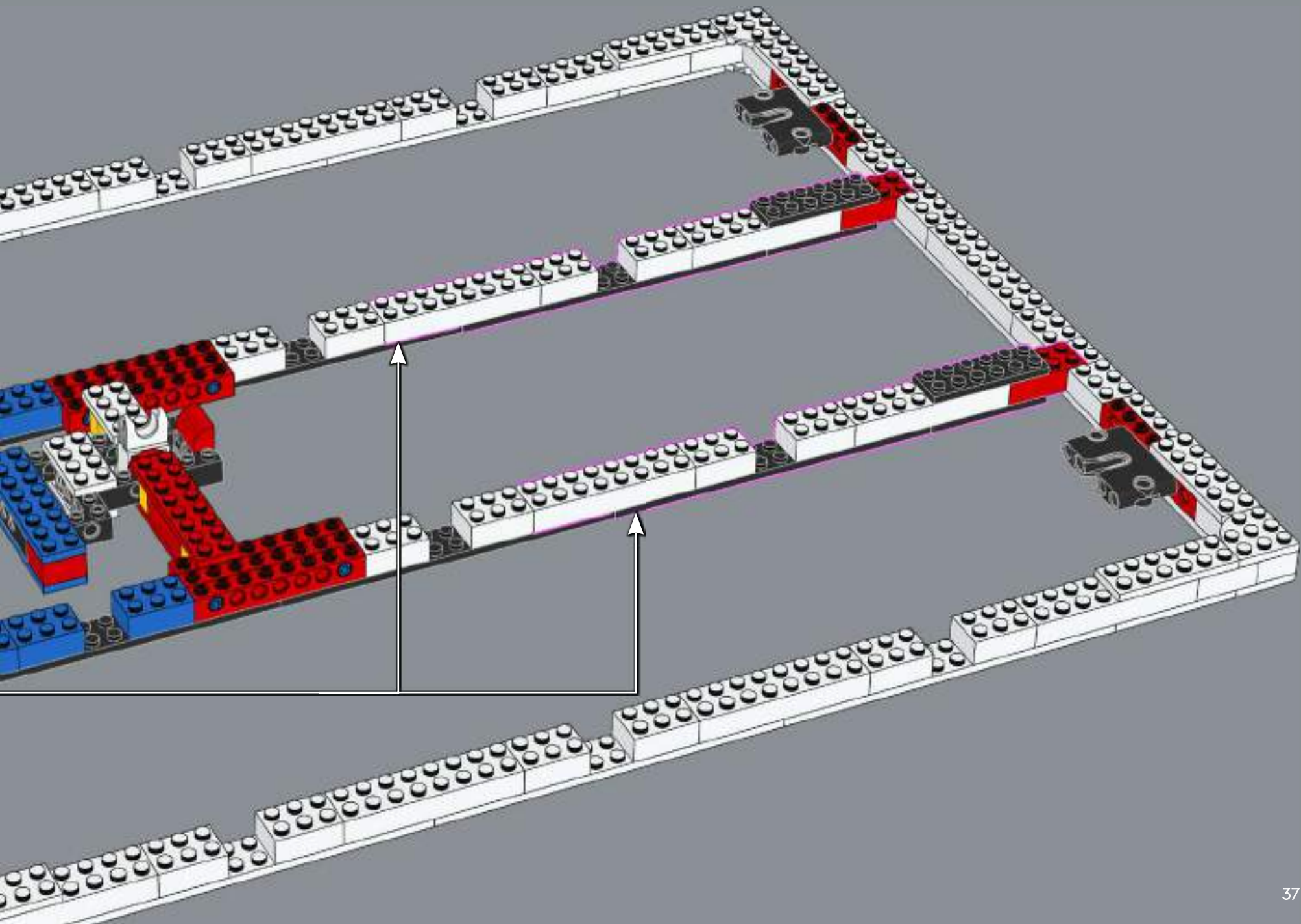

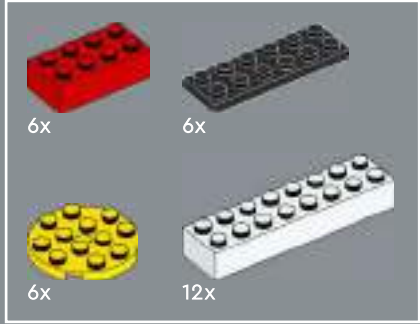
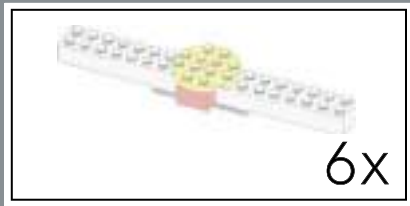

27

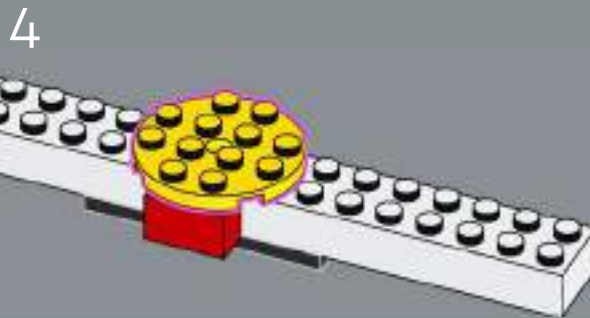
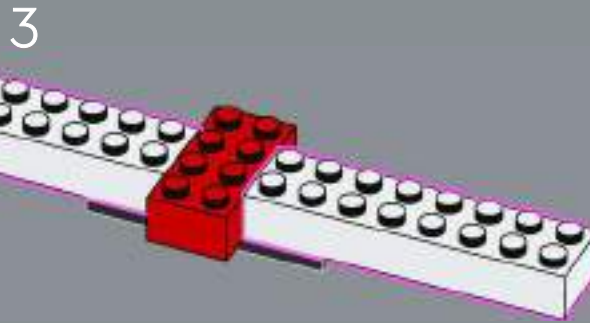
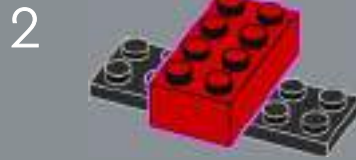

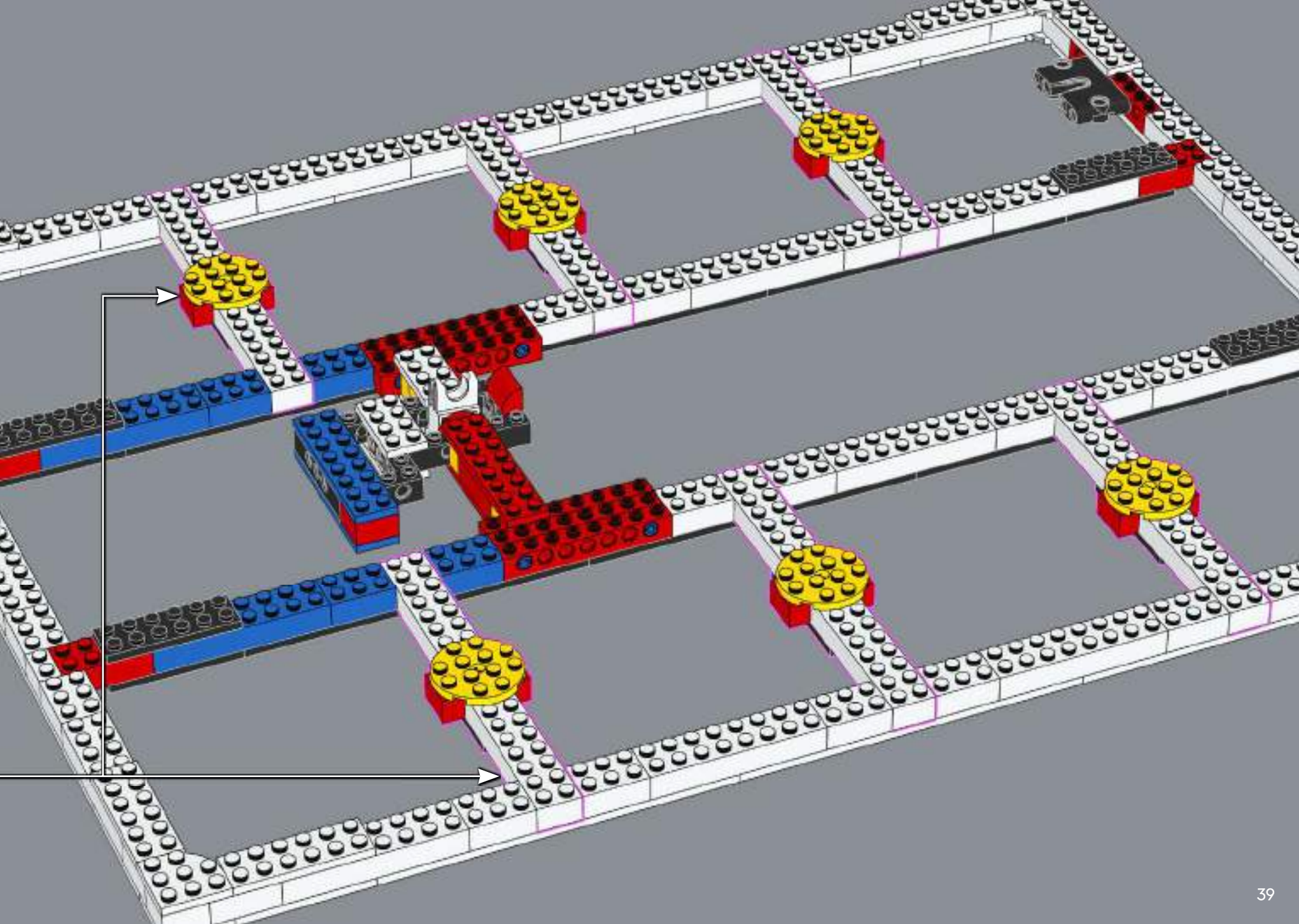

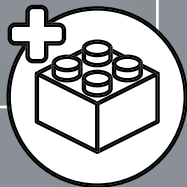
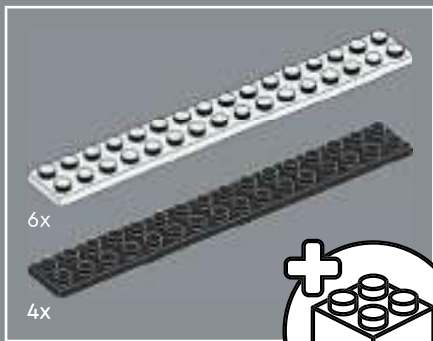

The colours used in this model were chosen to mimic the limited colours of both printed comics and LEGO® elements in the 1960s!

29

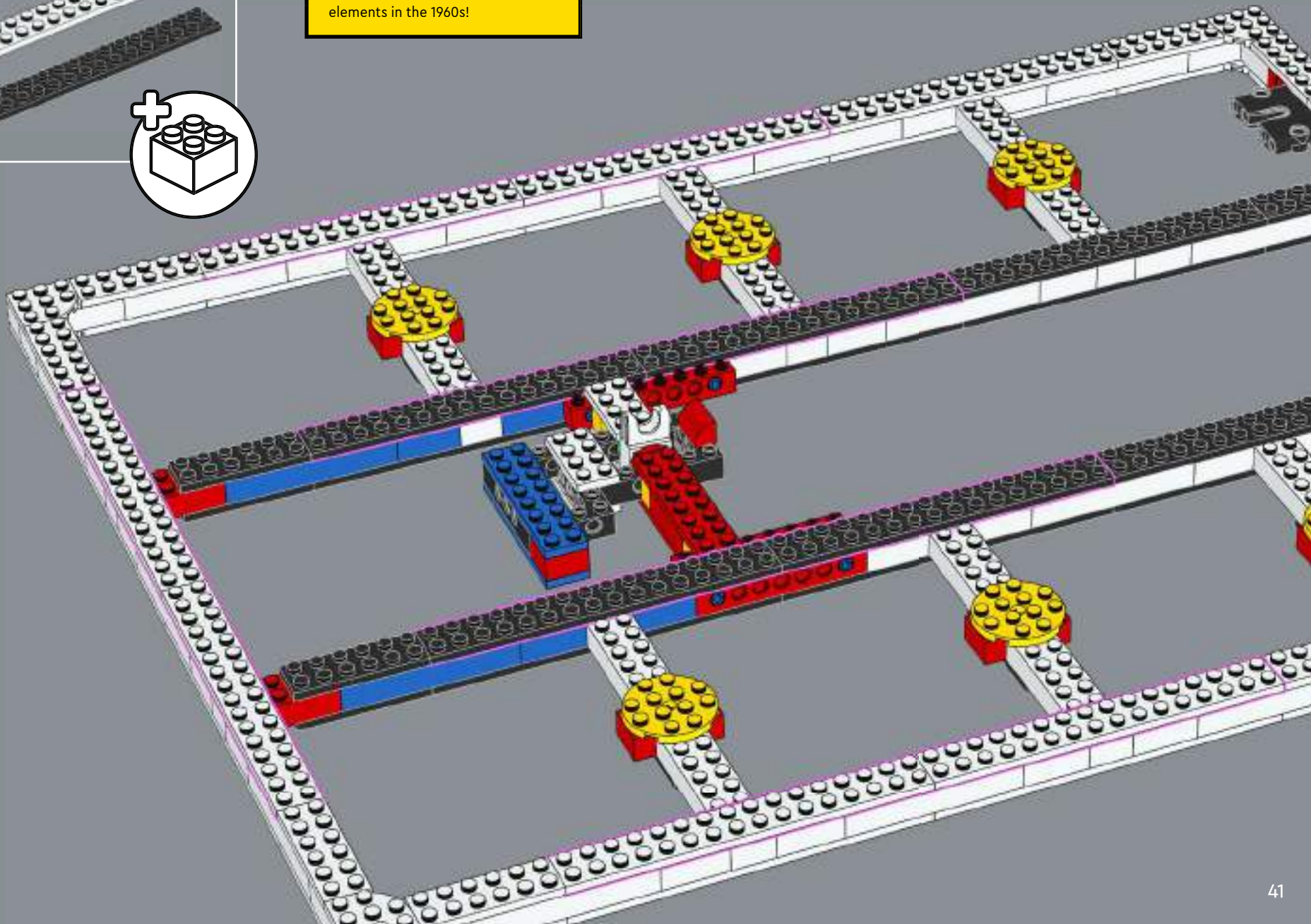



30

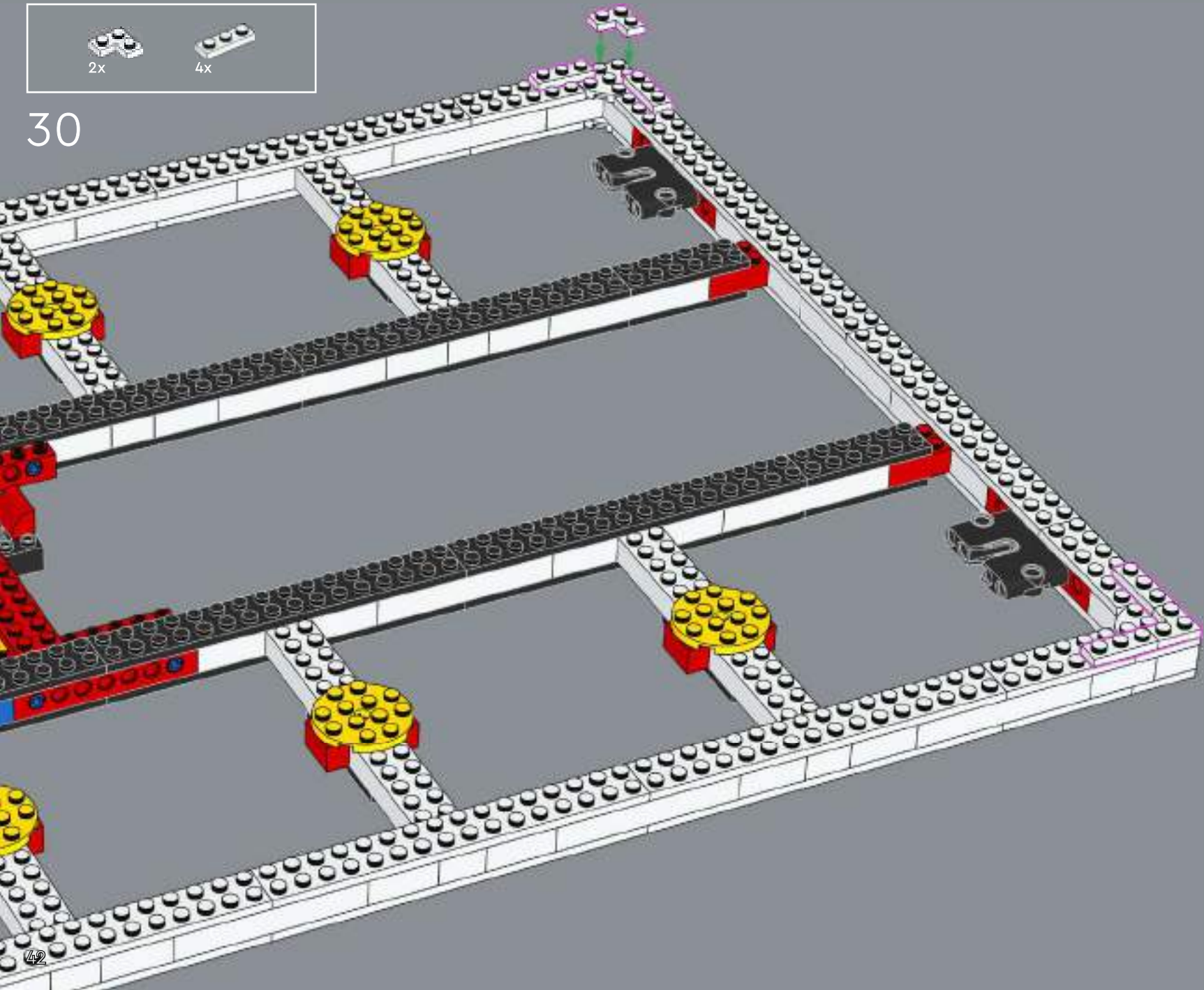

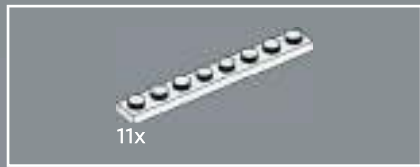

31

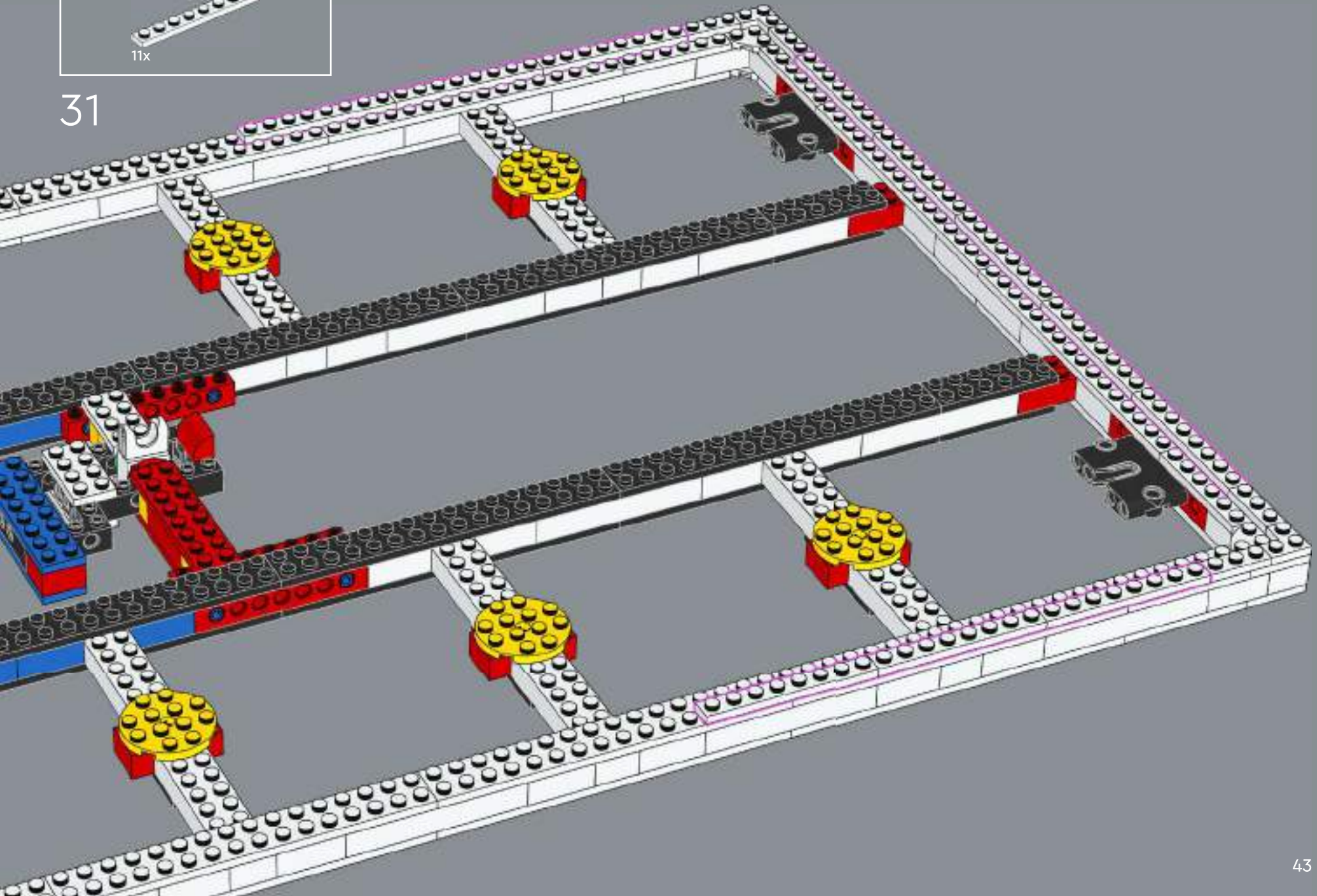



32

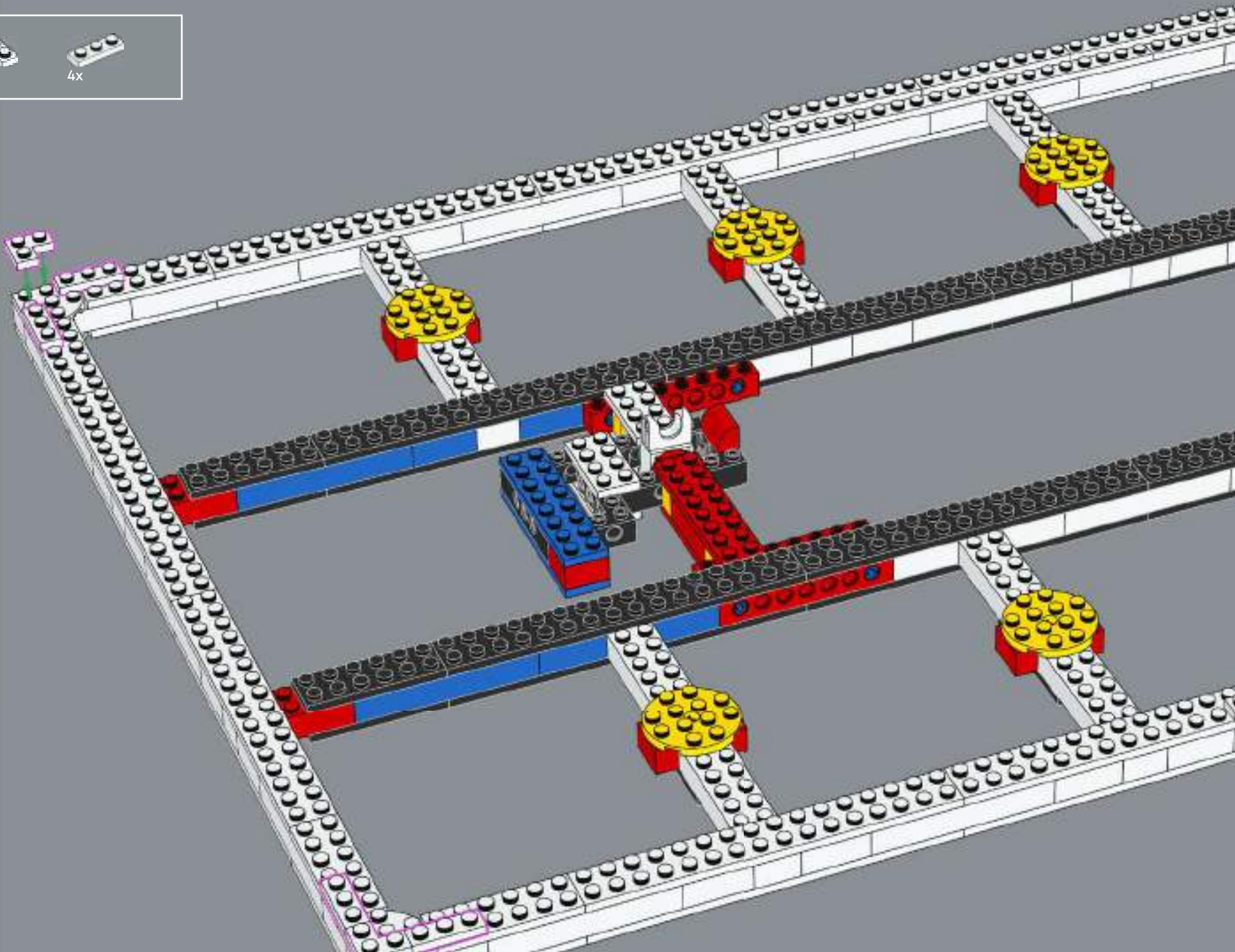

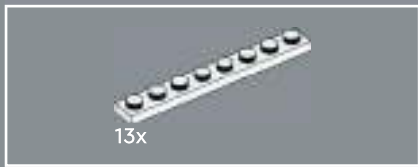

33

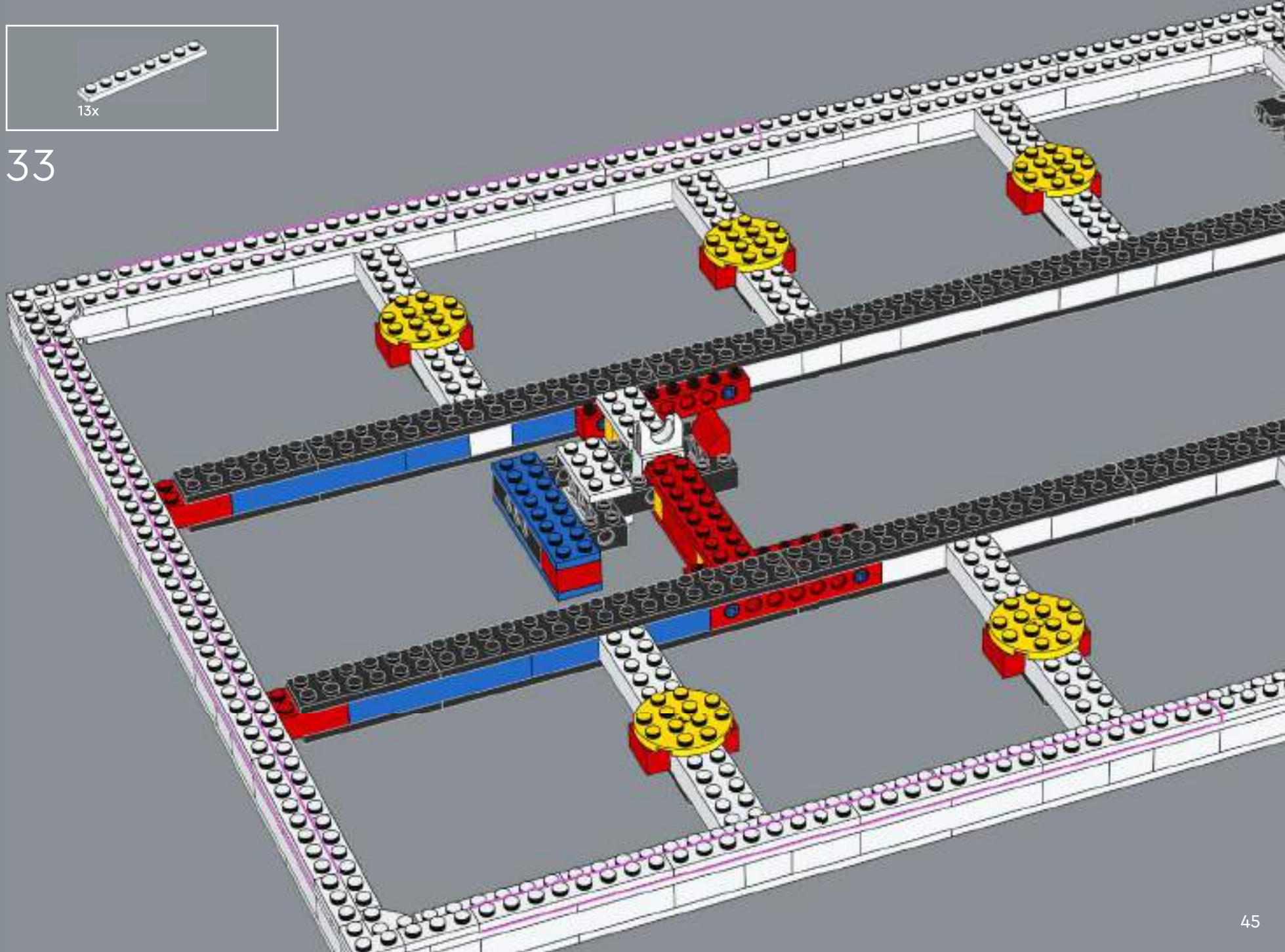

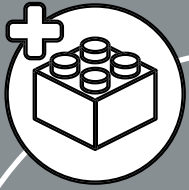

3x

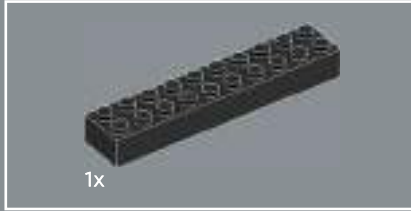
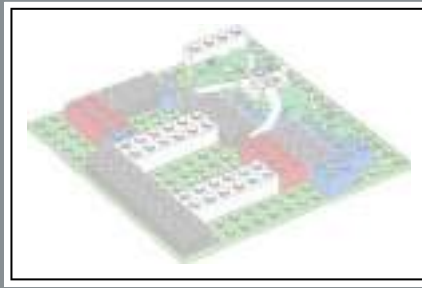

1x

34

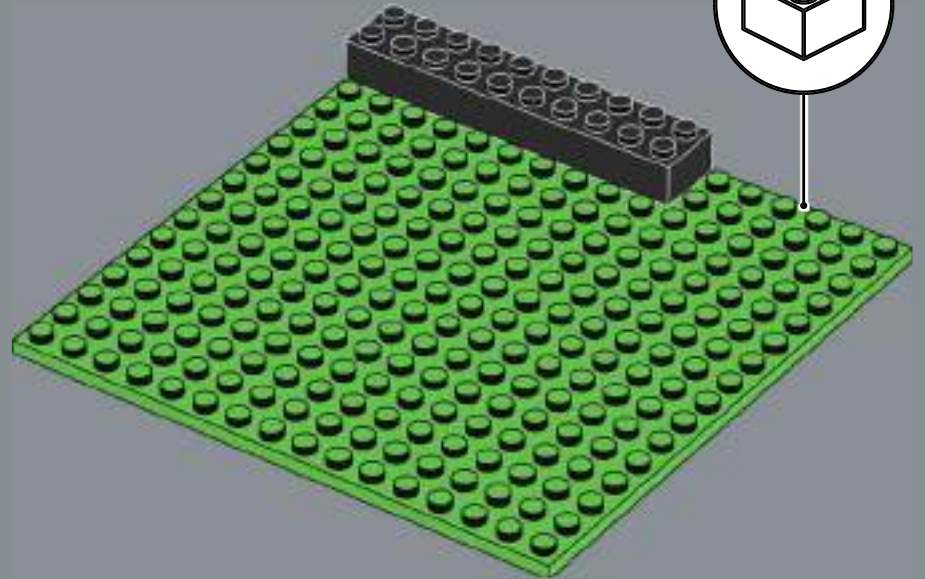
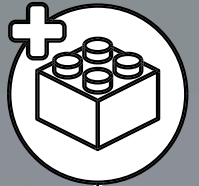

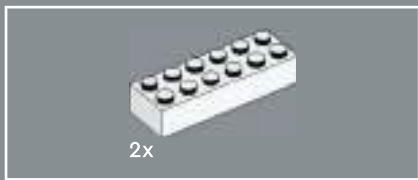

35

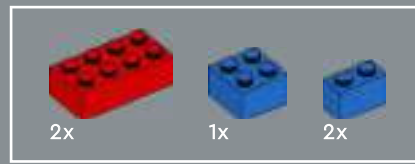
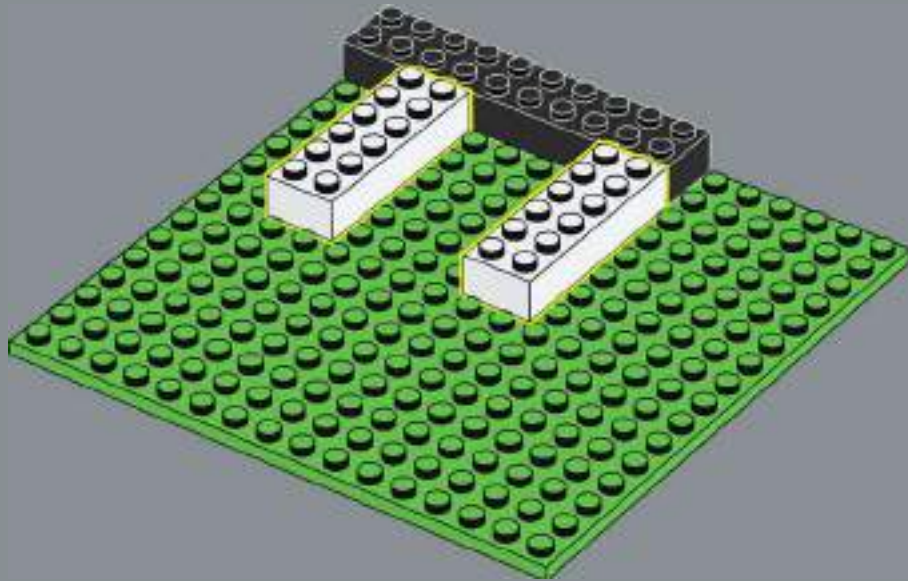

36

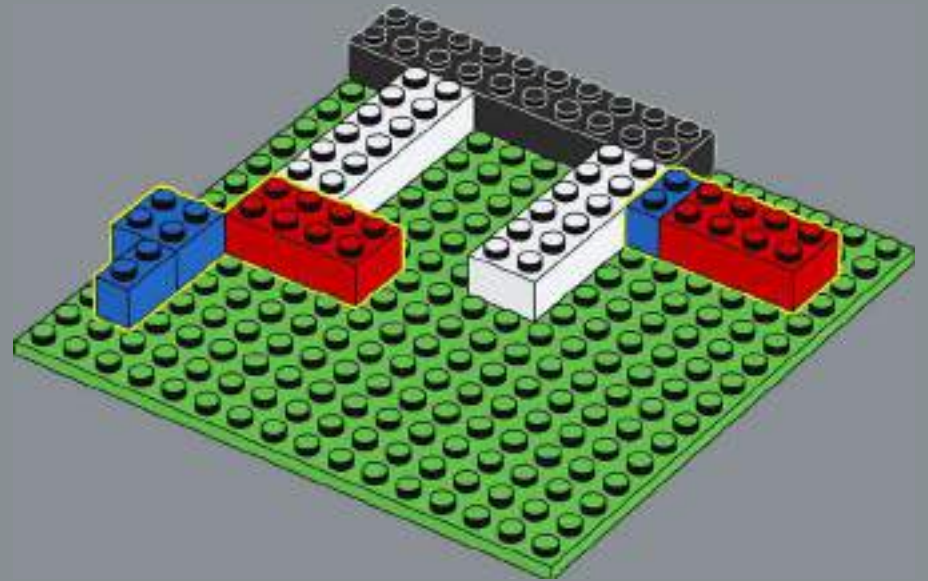



37

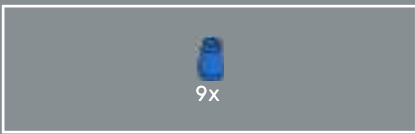
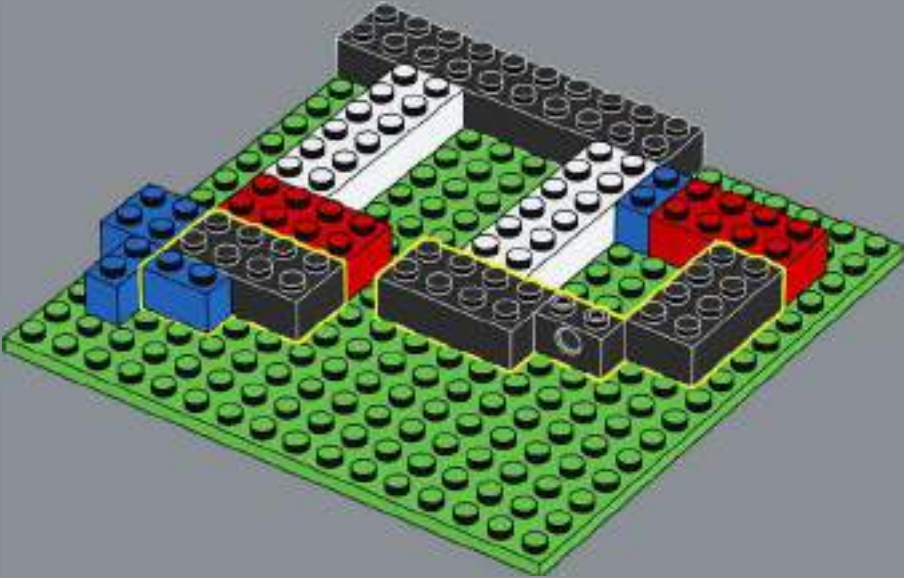

38

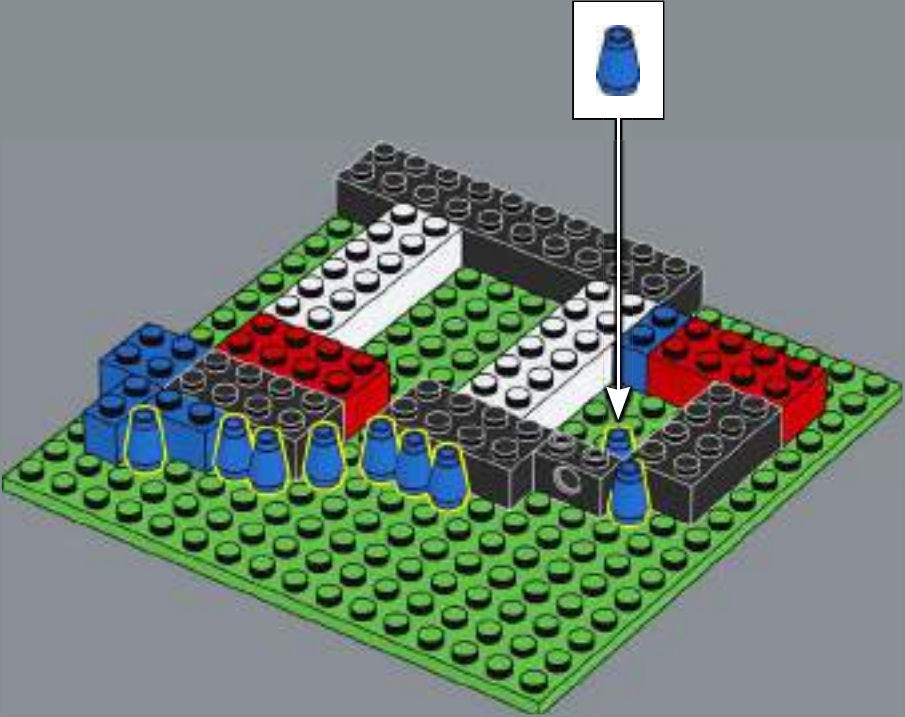

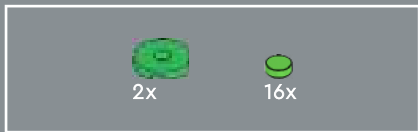

A note to builders – The crowbar element can be used to remove the occasional tile if you make a mistake! Take it from us – you've never seen a build like this before ...

39

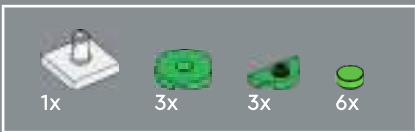
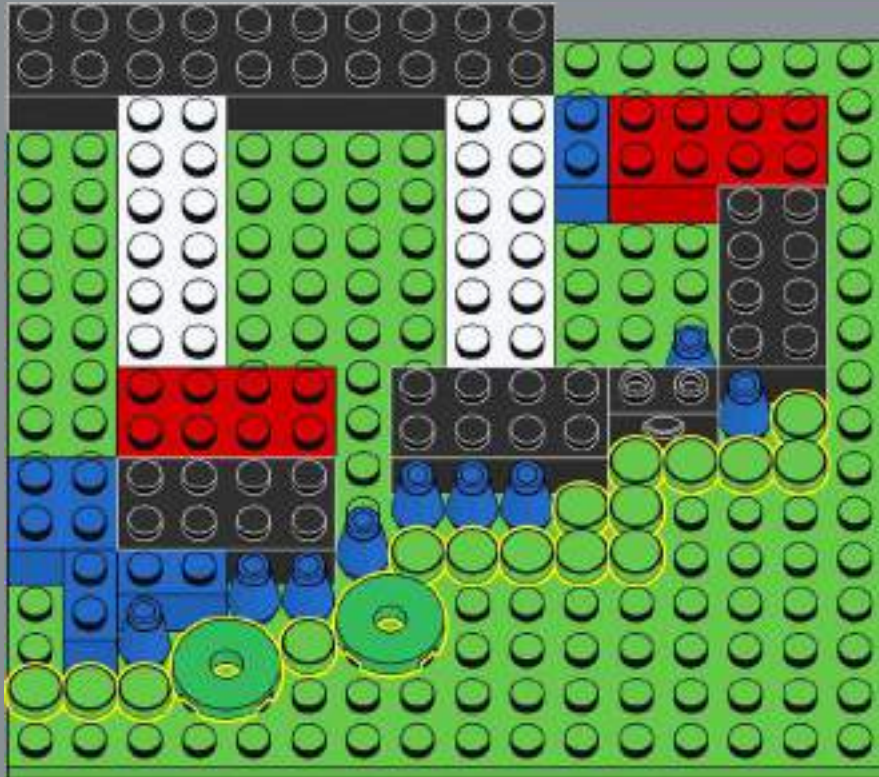

40

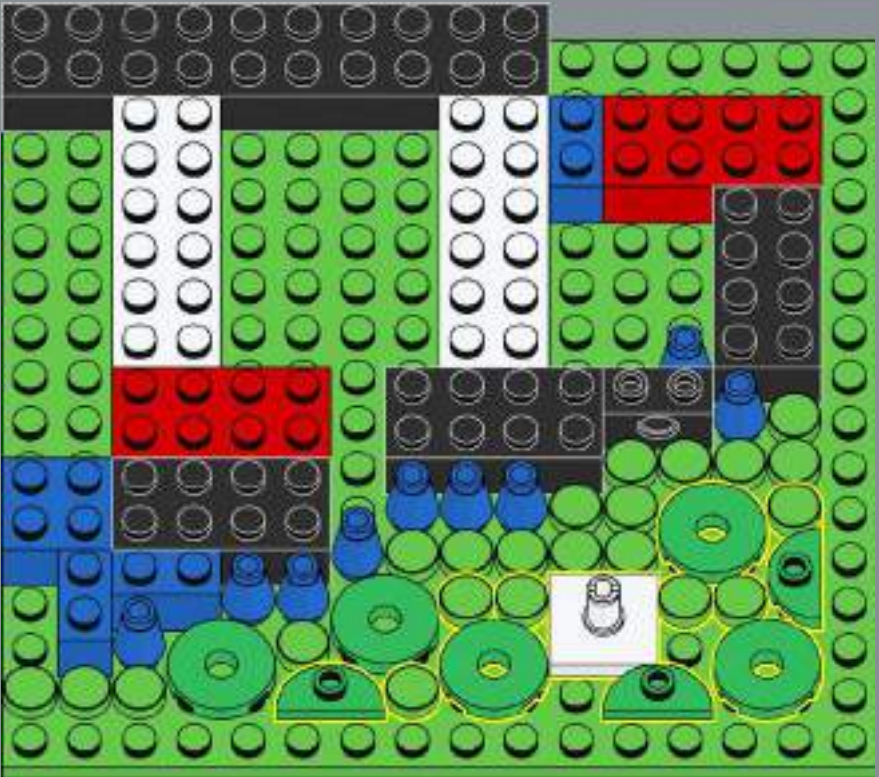



41

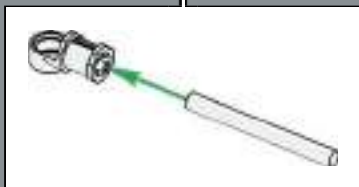
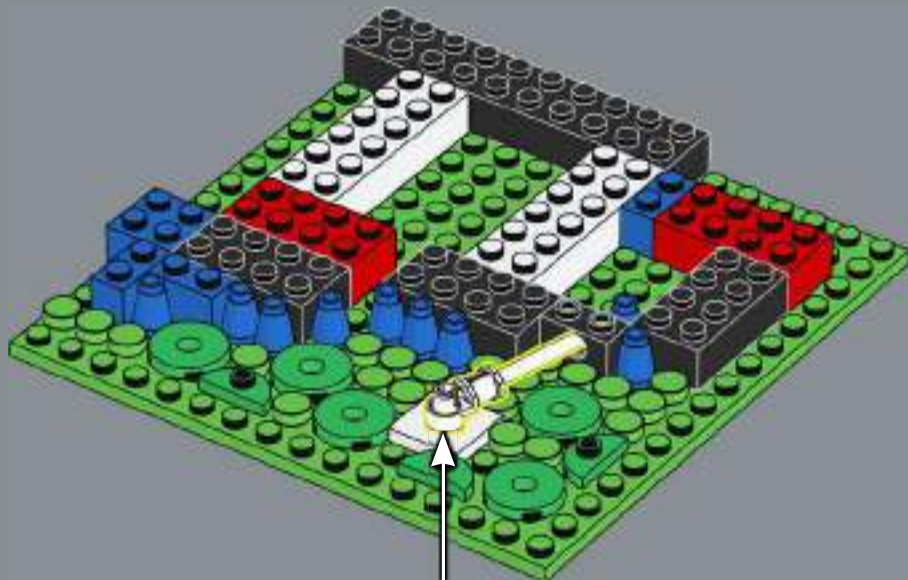

42

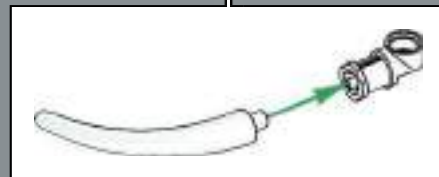
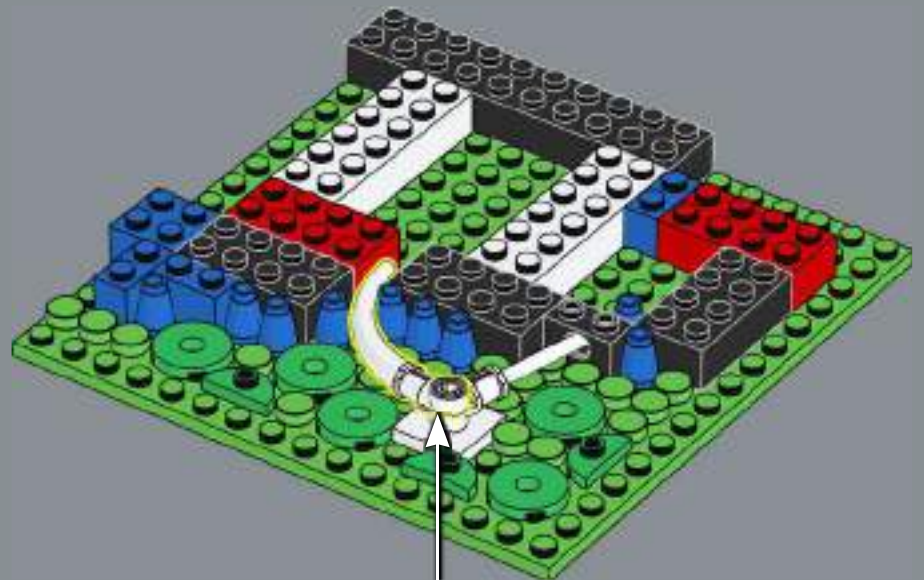



43

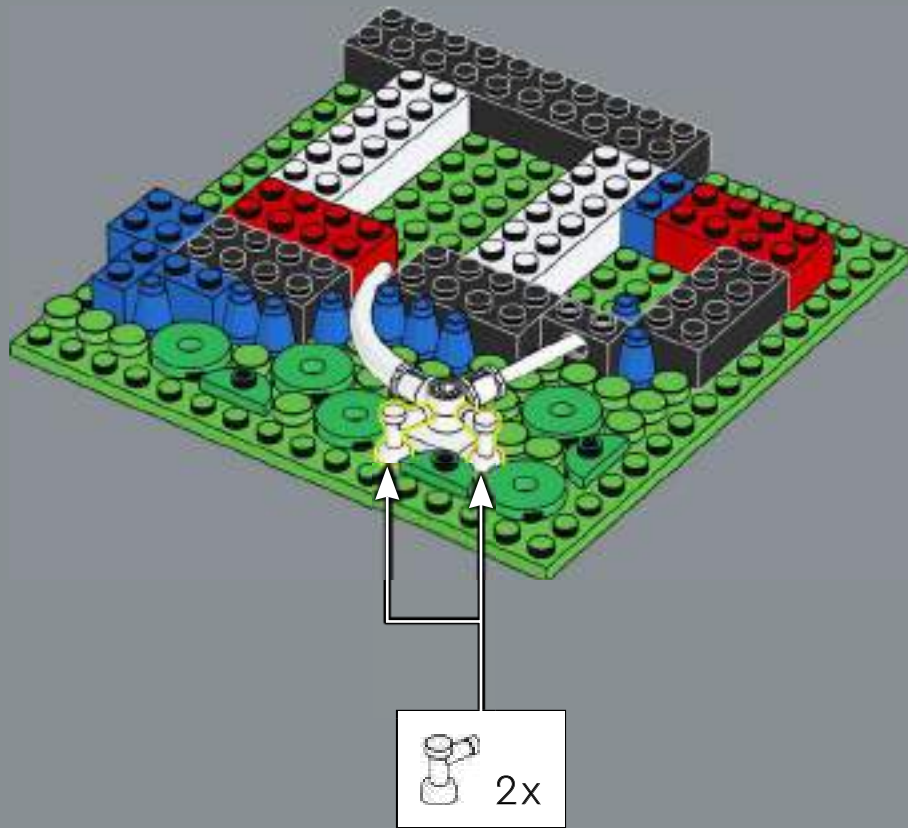

44

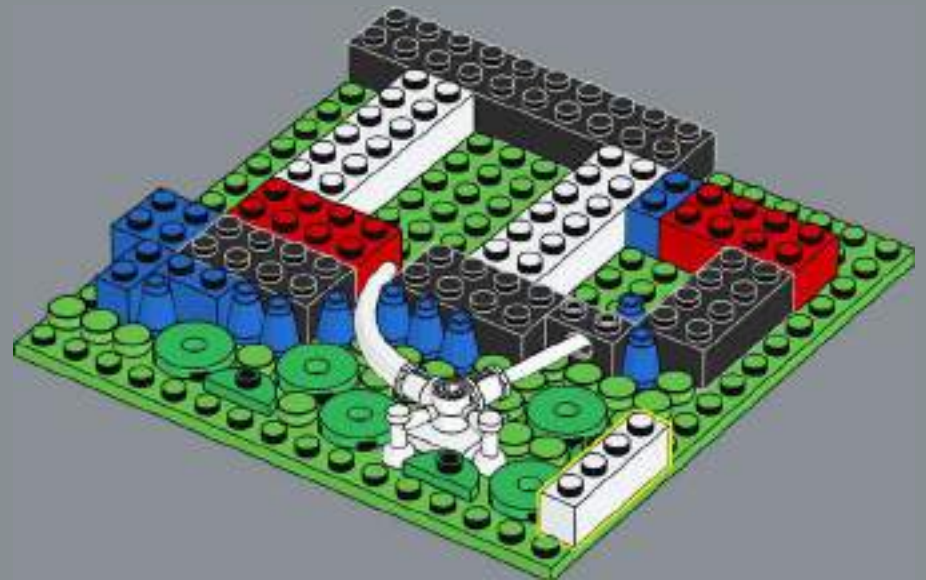

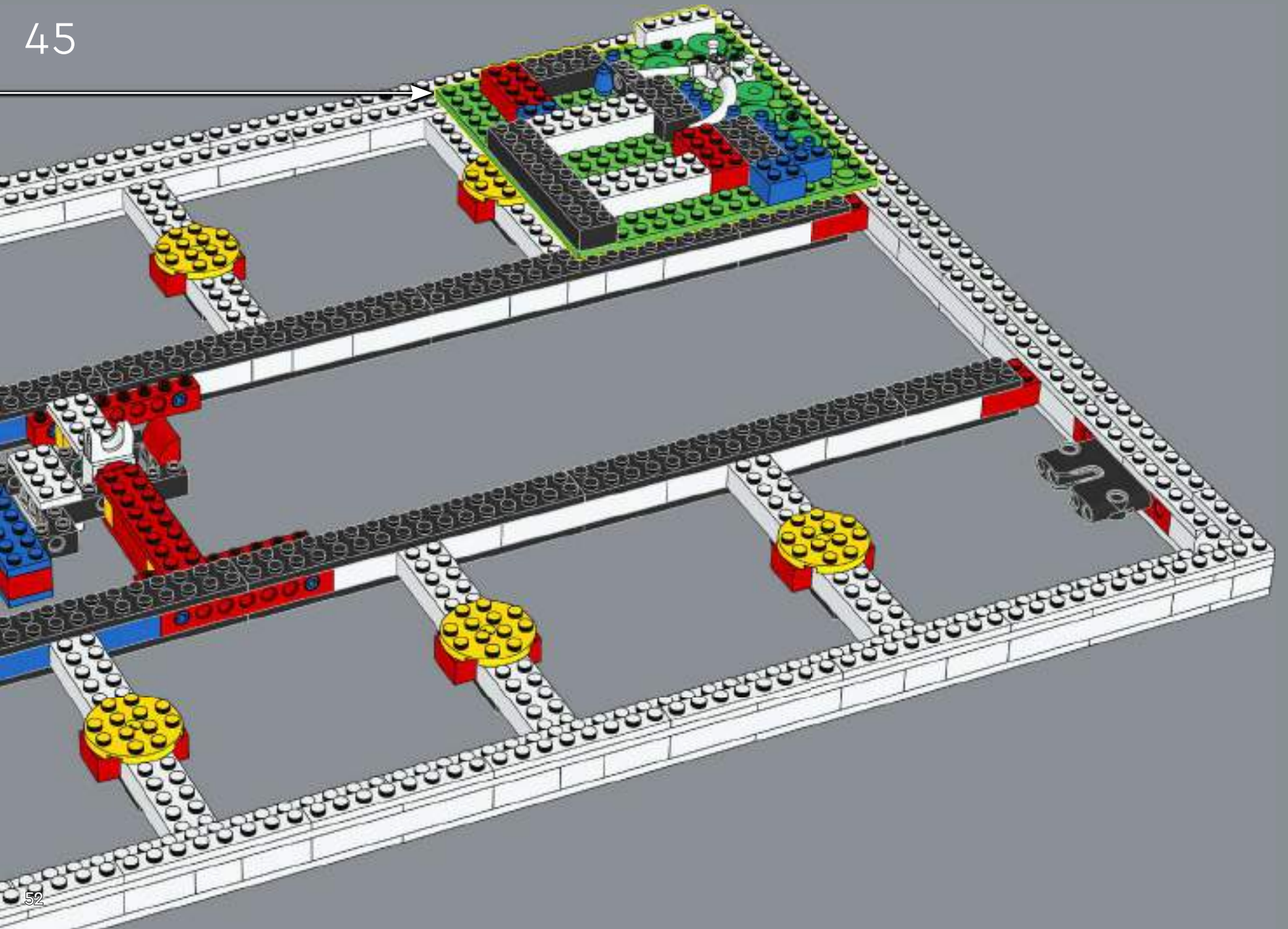

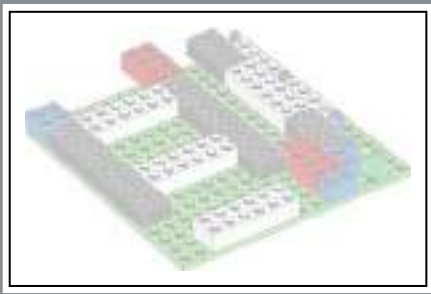

46

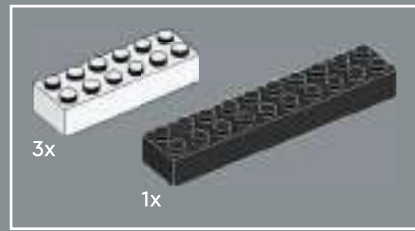
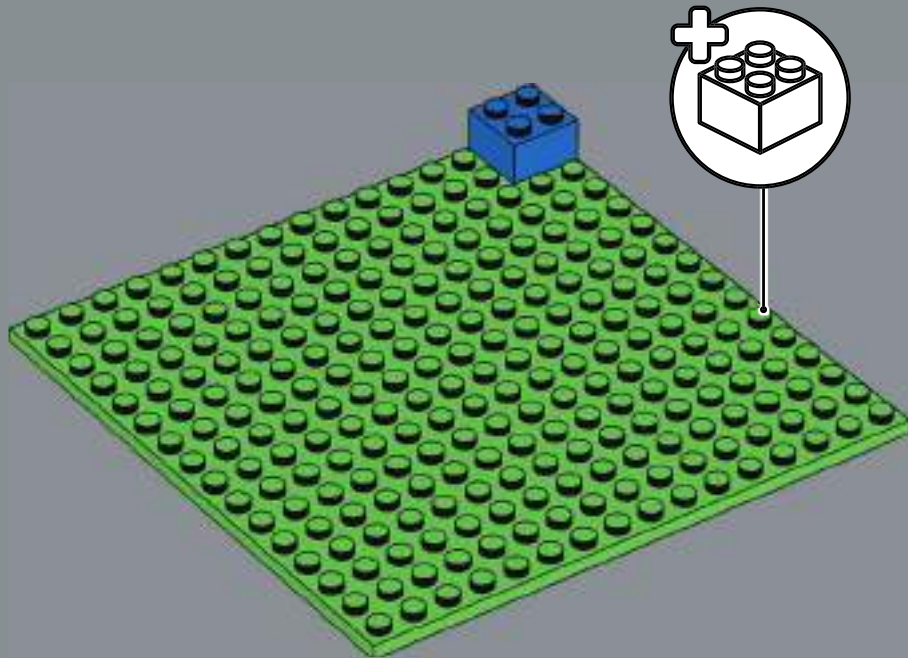

47

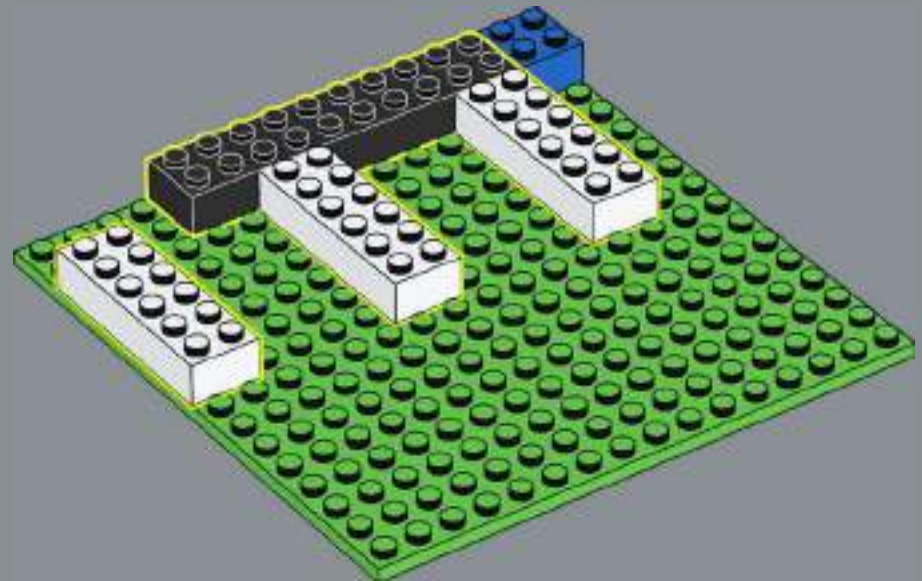

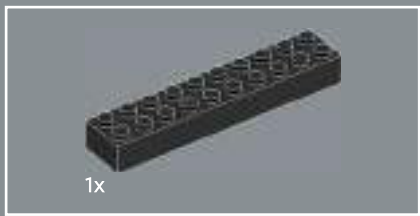

48

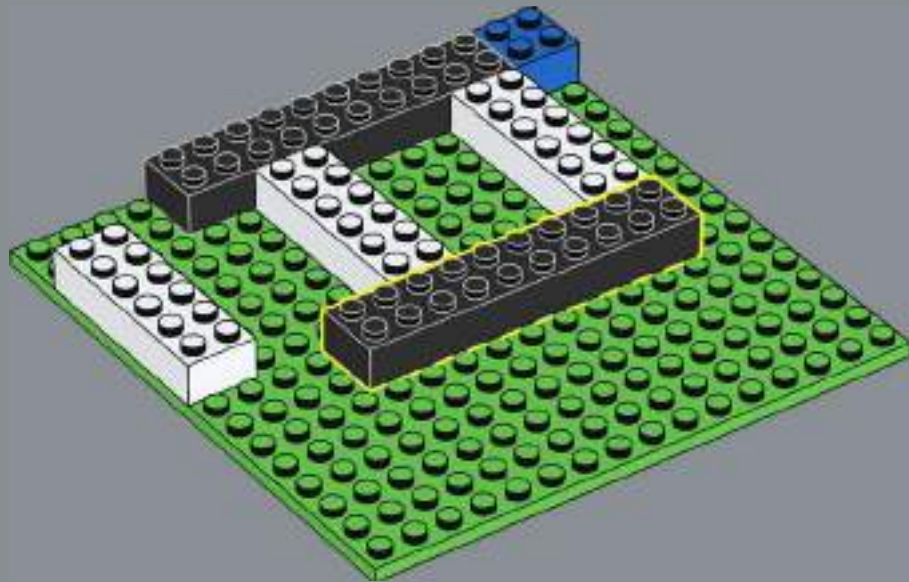

49

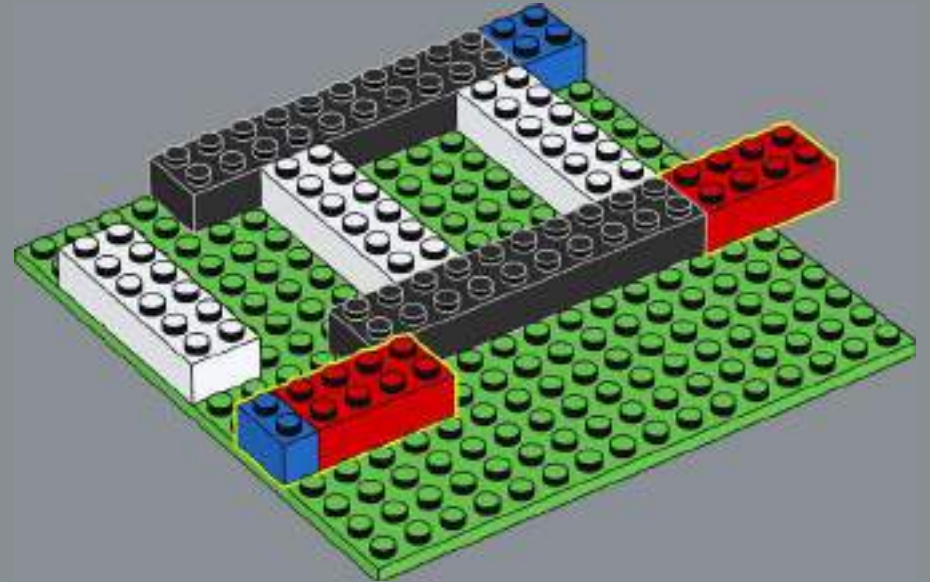

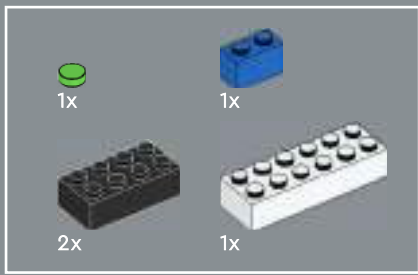

50

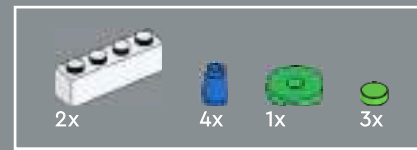
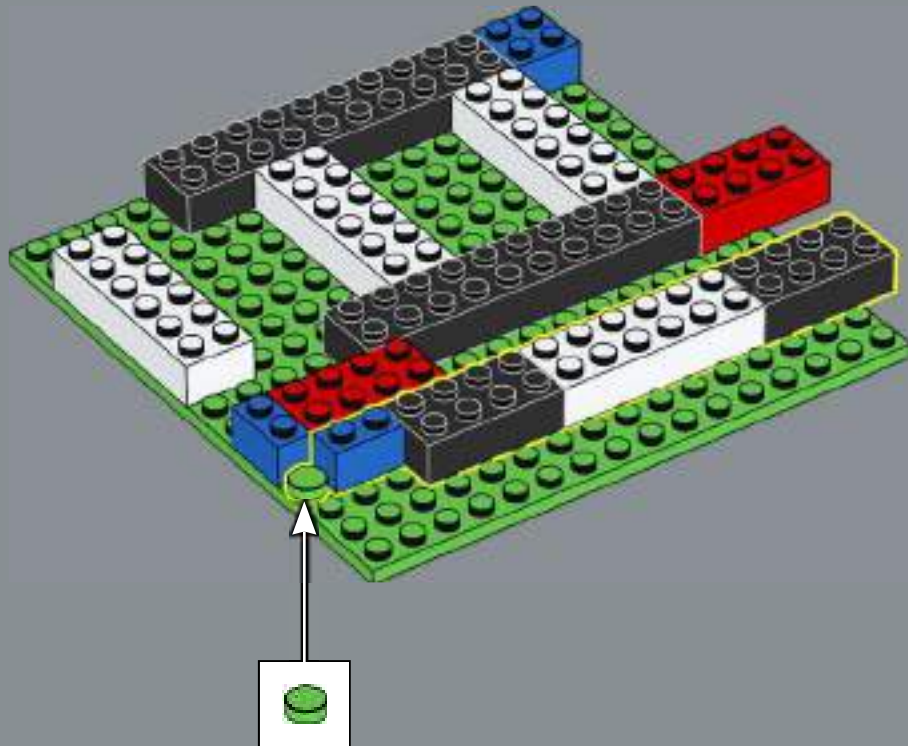

51

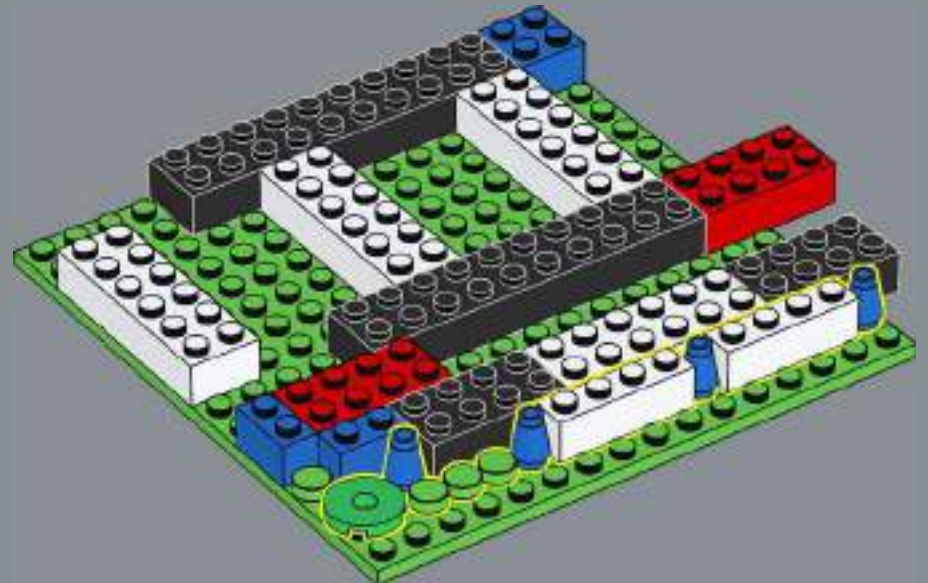

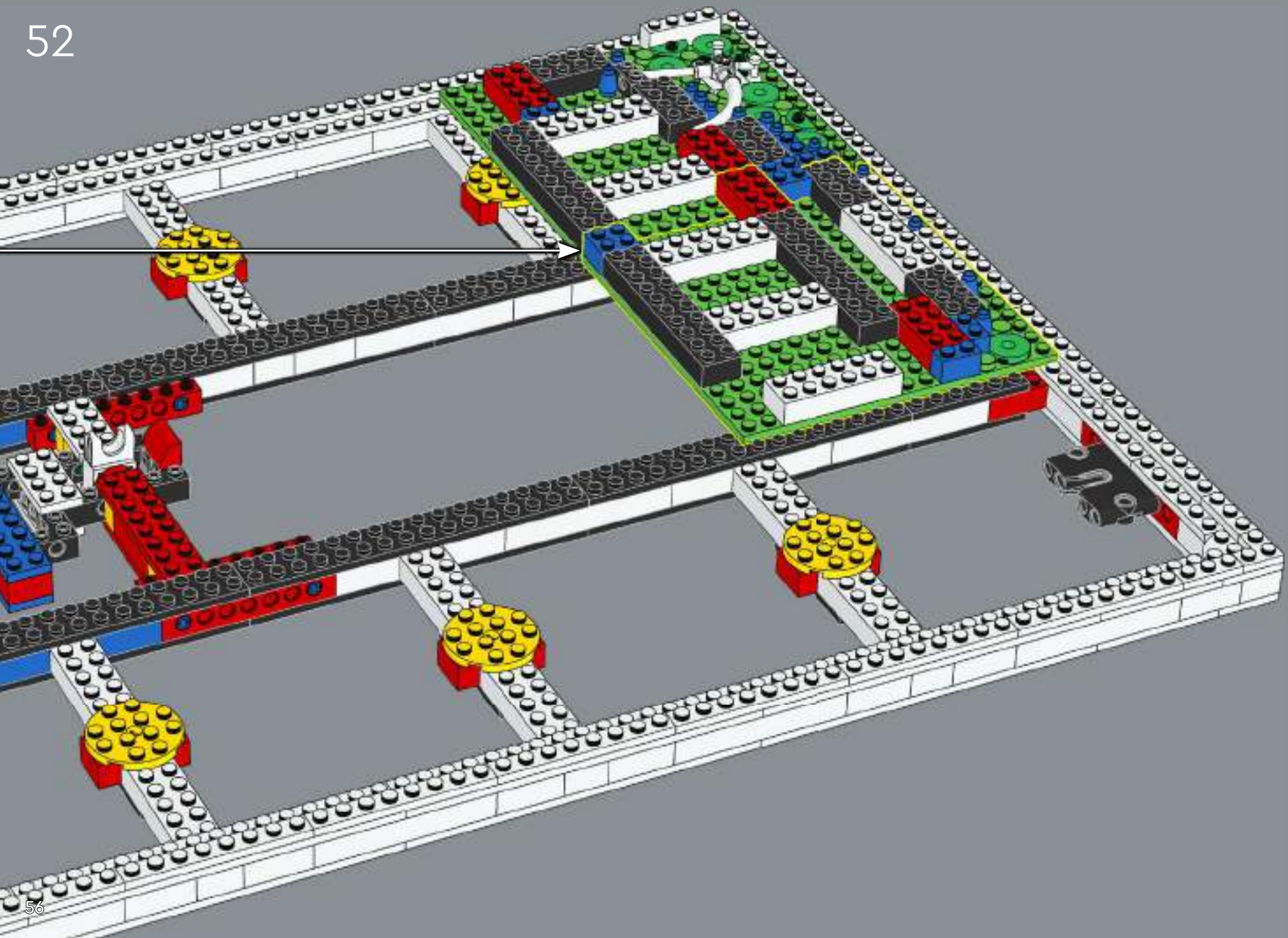

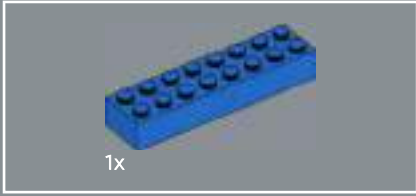

53

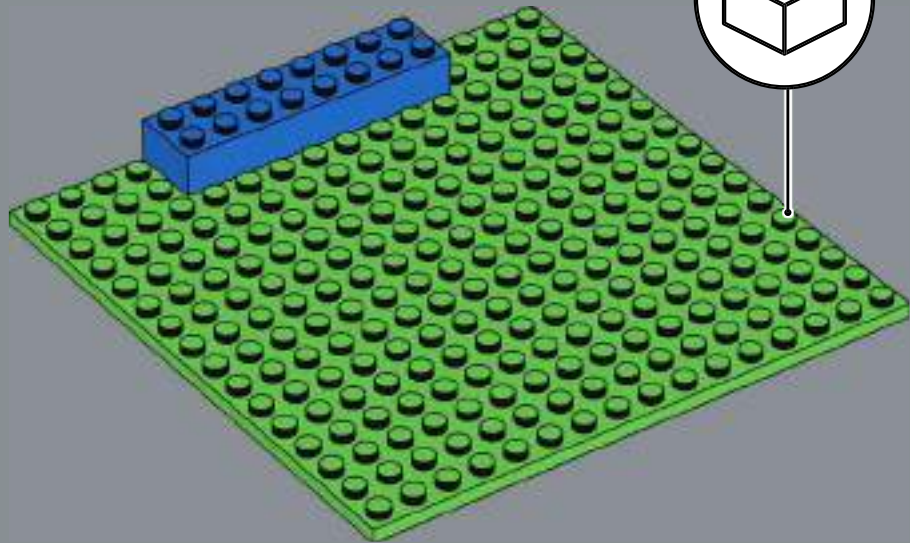

54

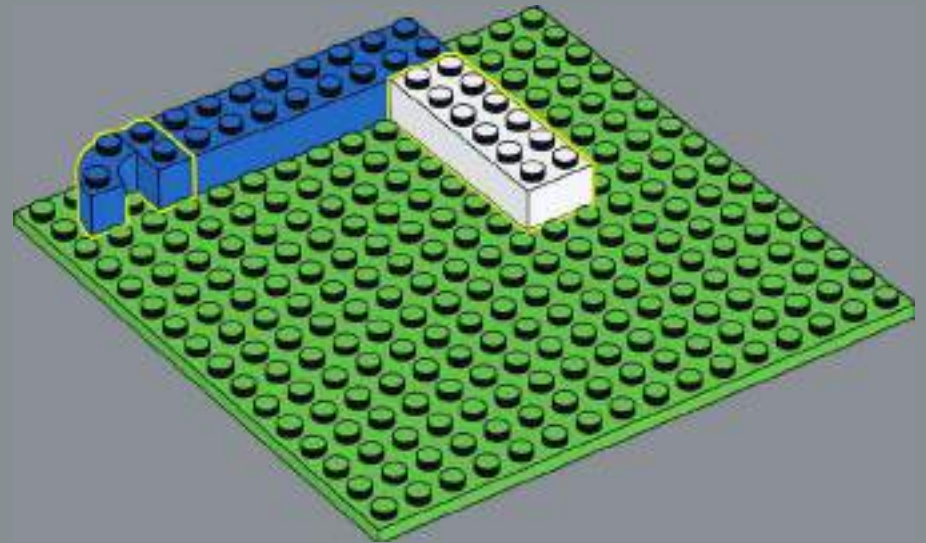

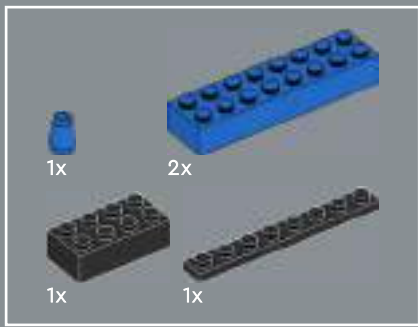

55

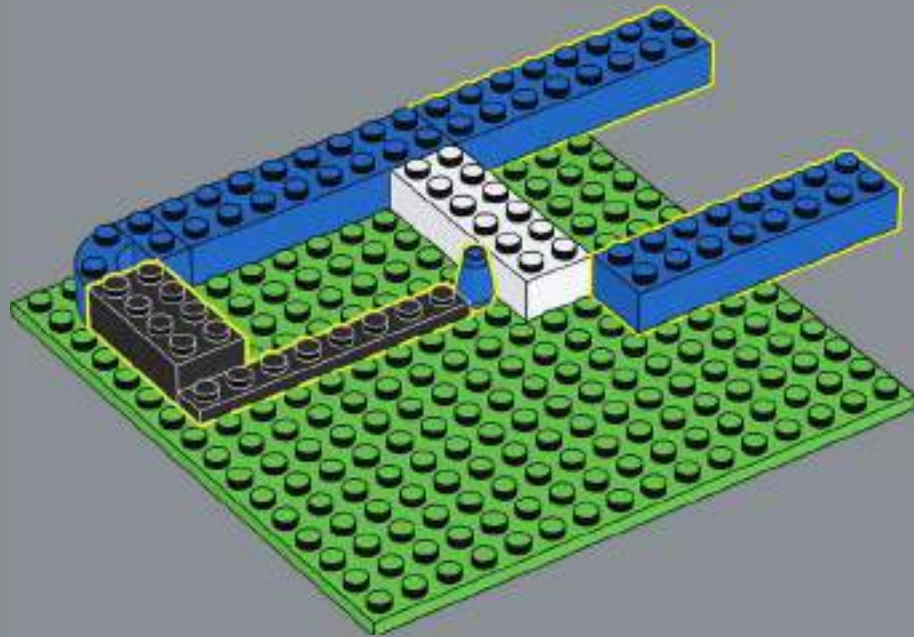

56

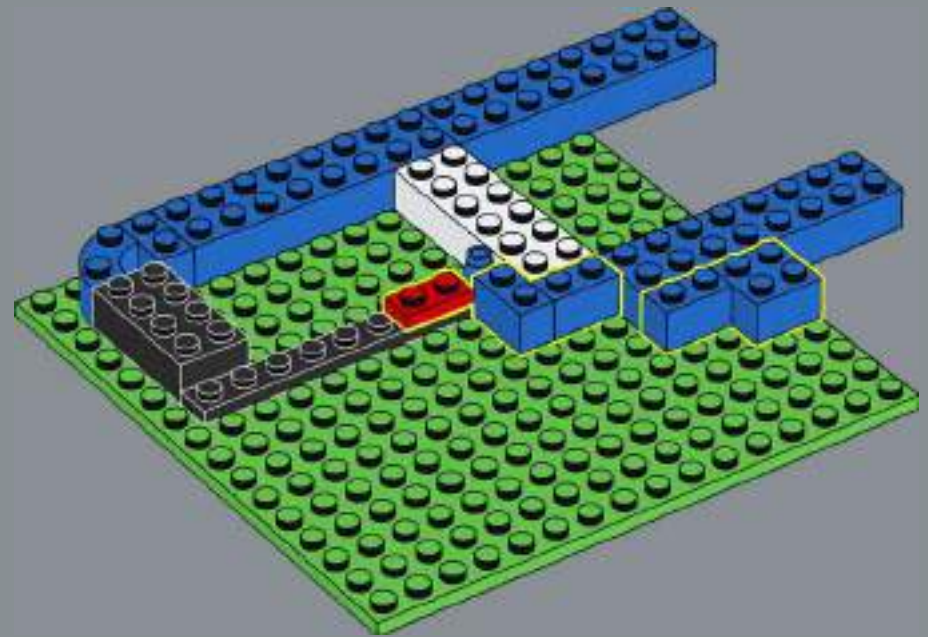



57

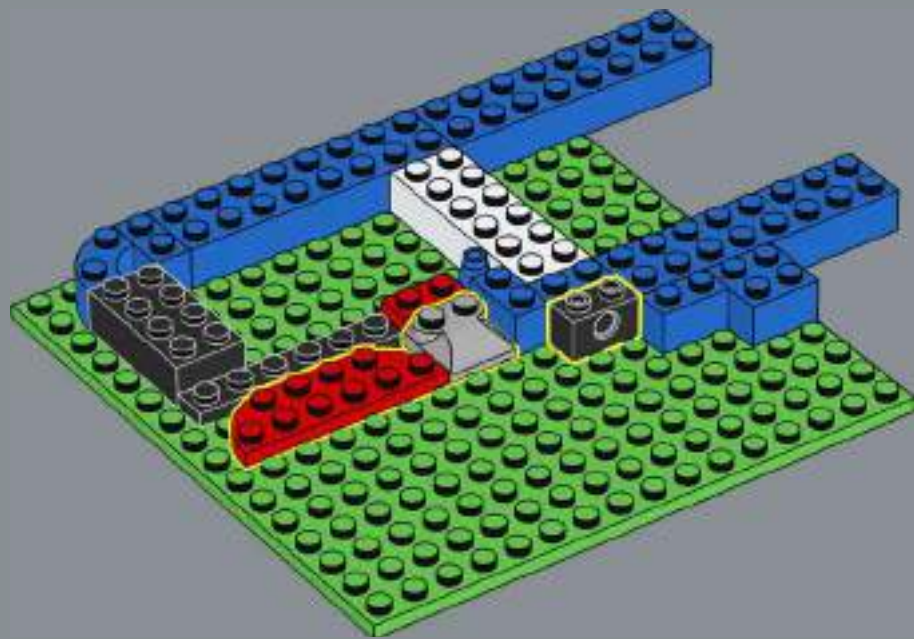

58

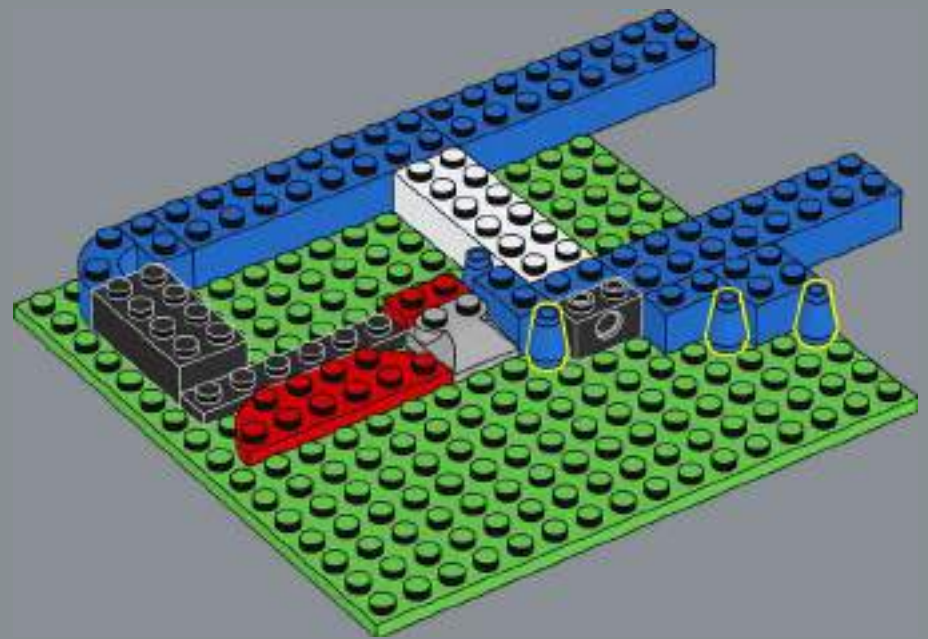

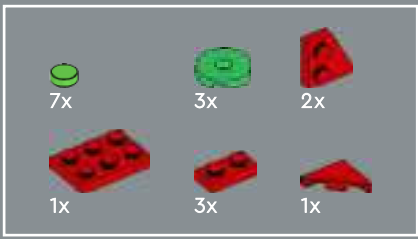

59

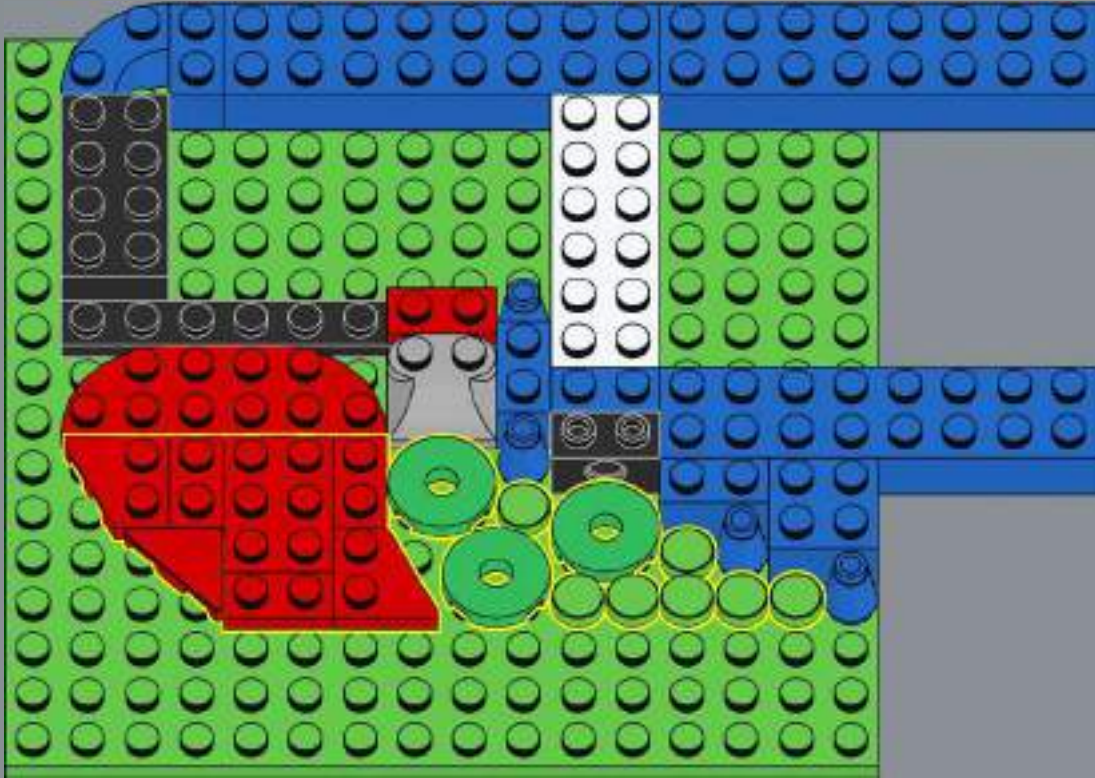

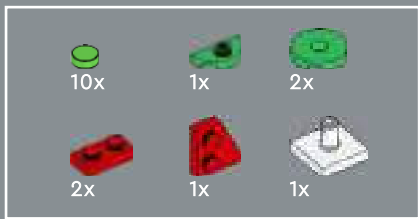

60

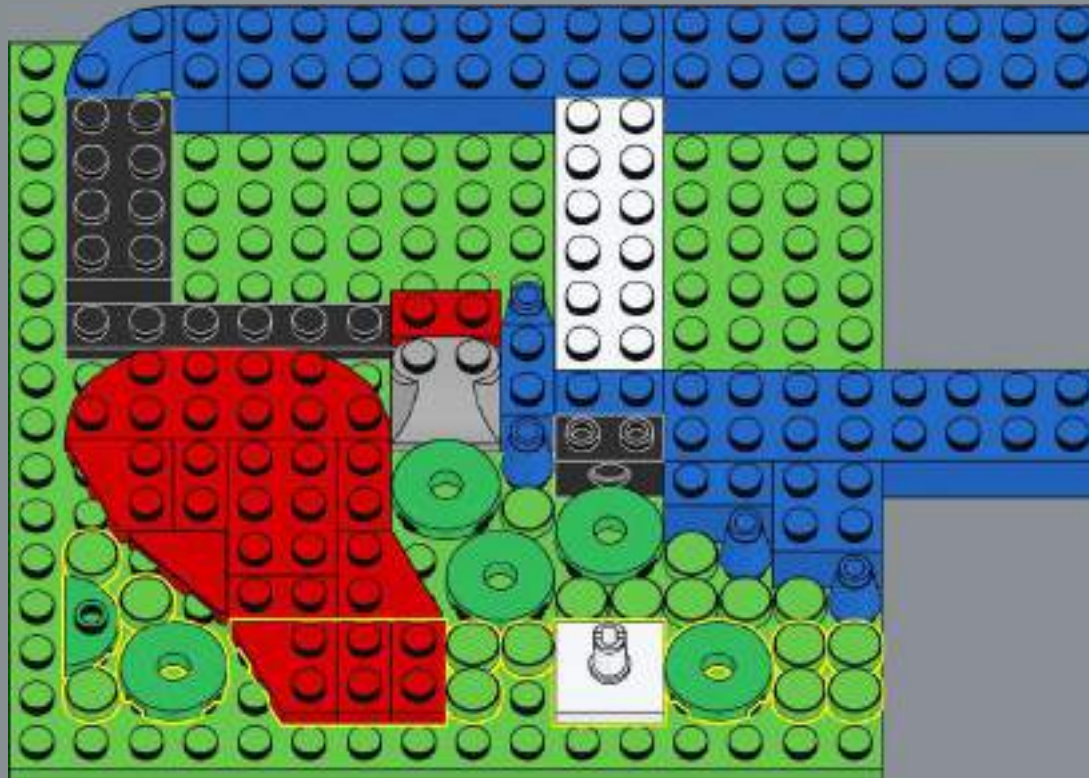

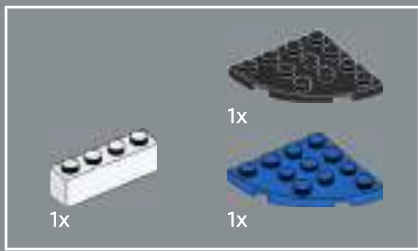

62

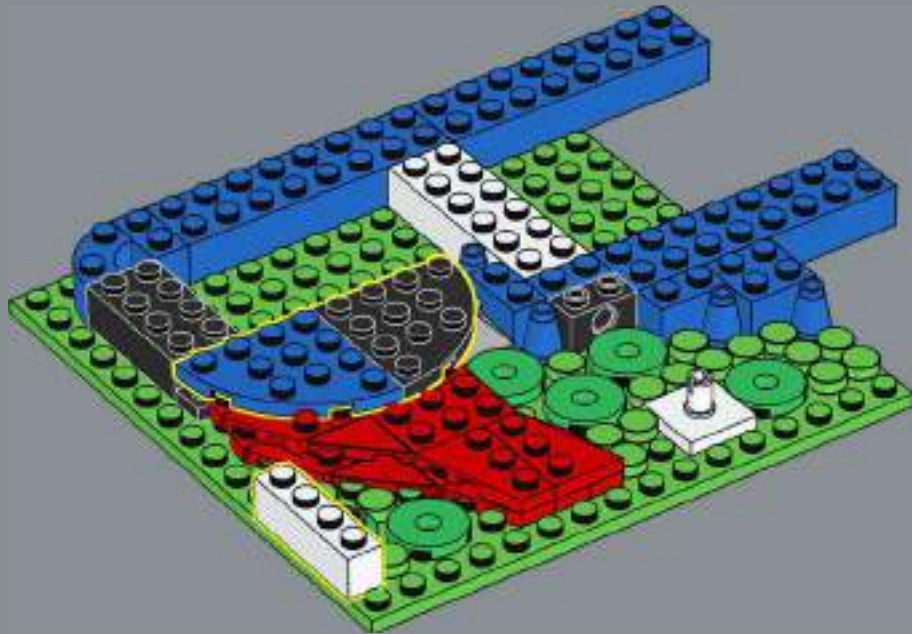

63

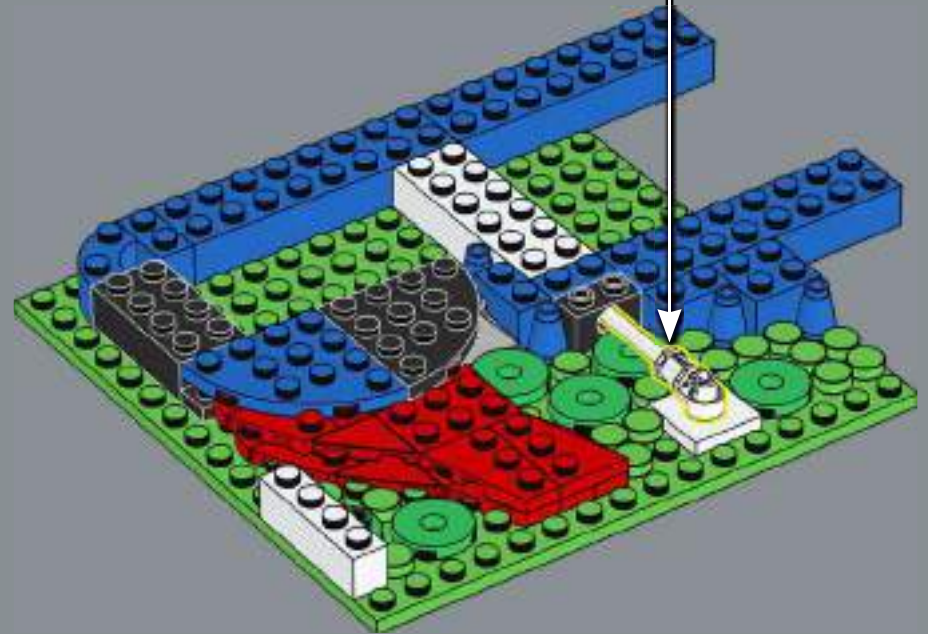
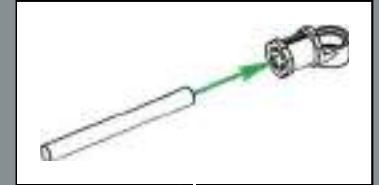



64

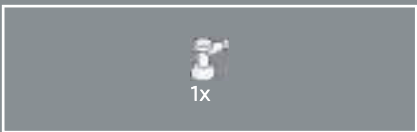
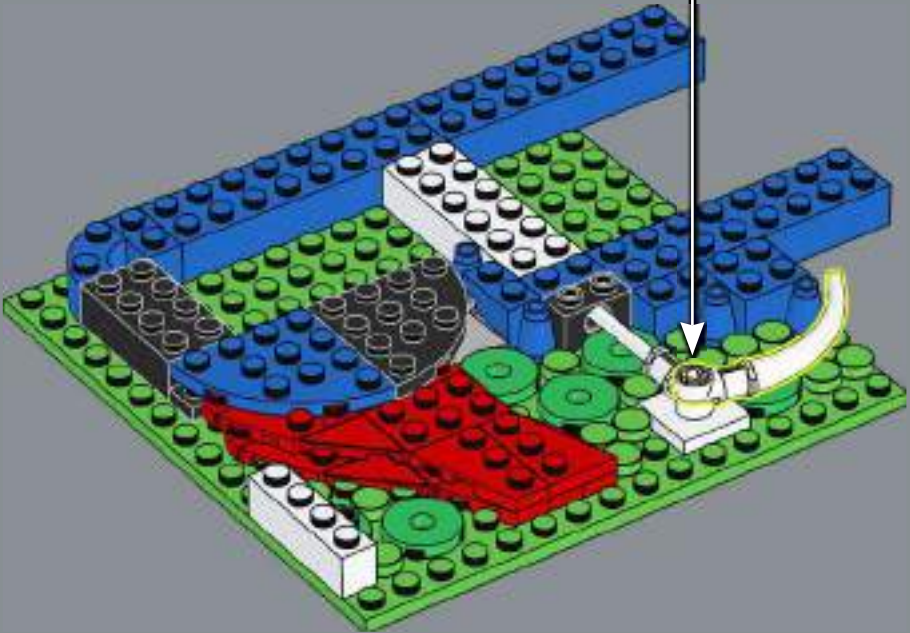
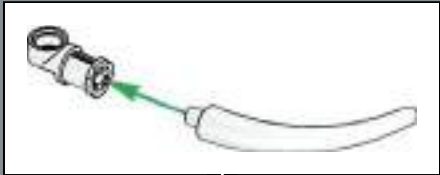

65

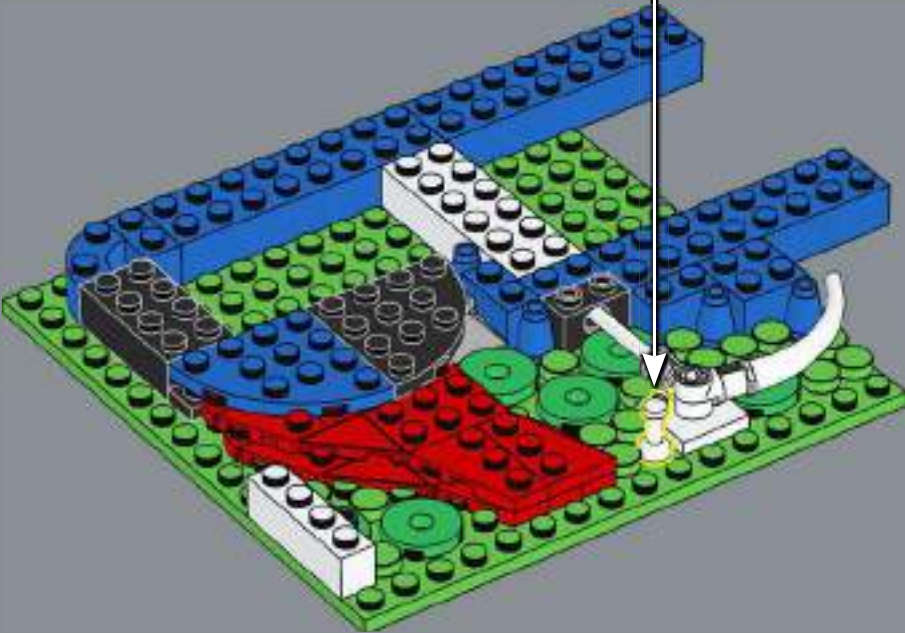

66

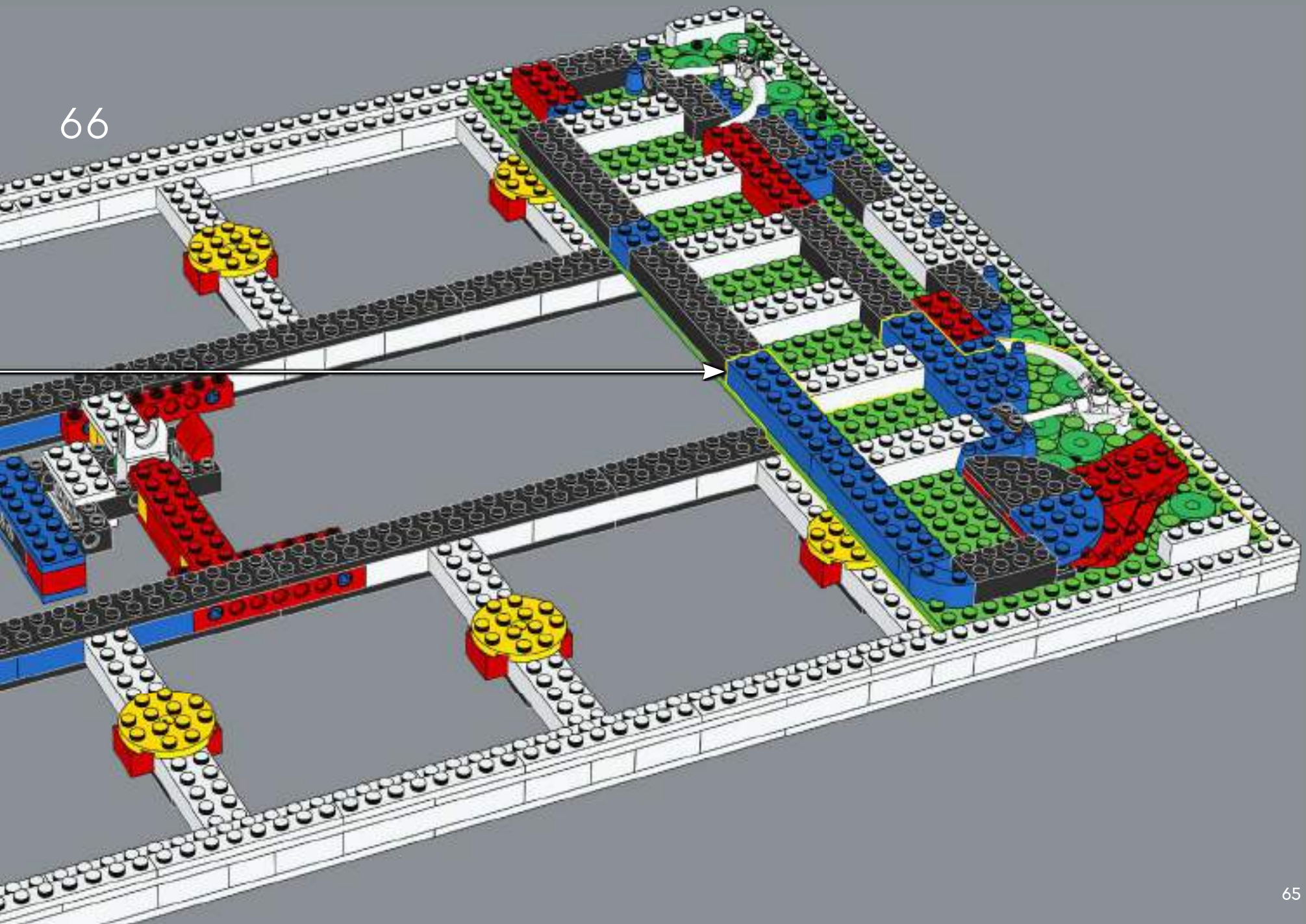

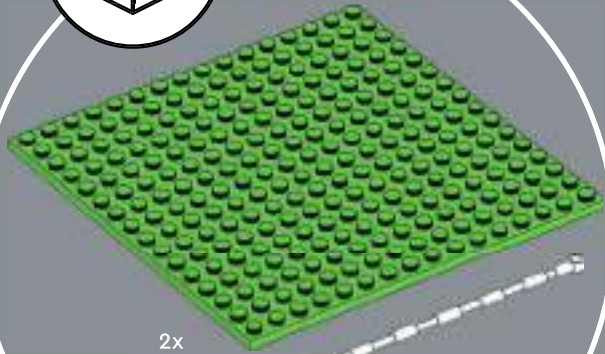
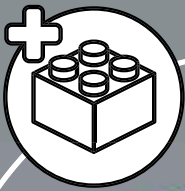

2x

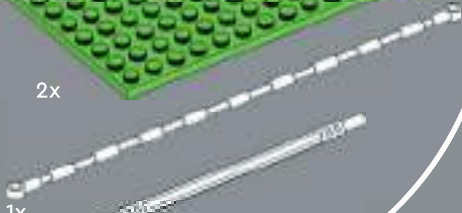

1x



2x



1x

67

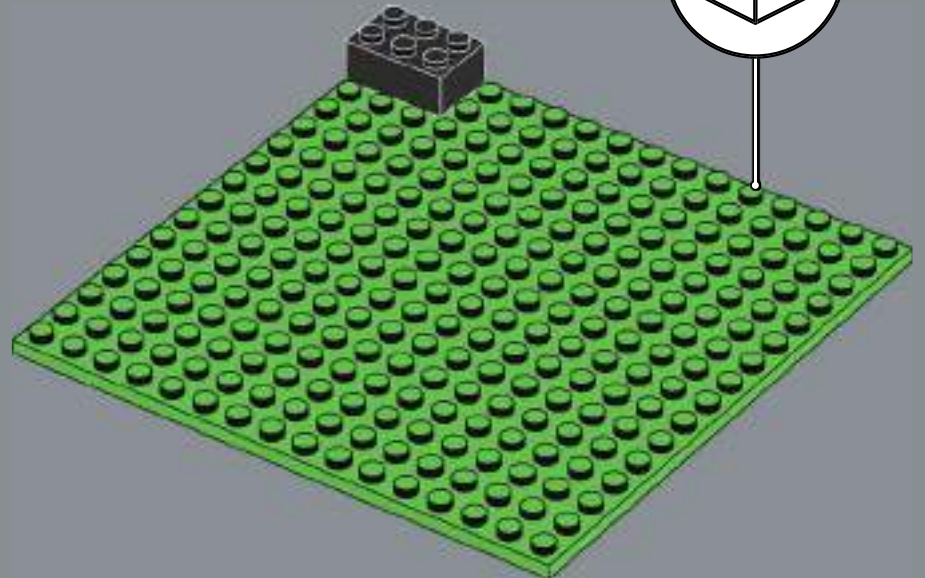
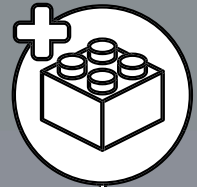



68

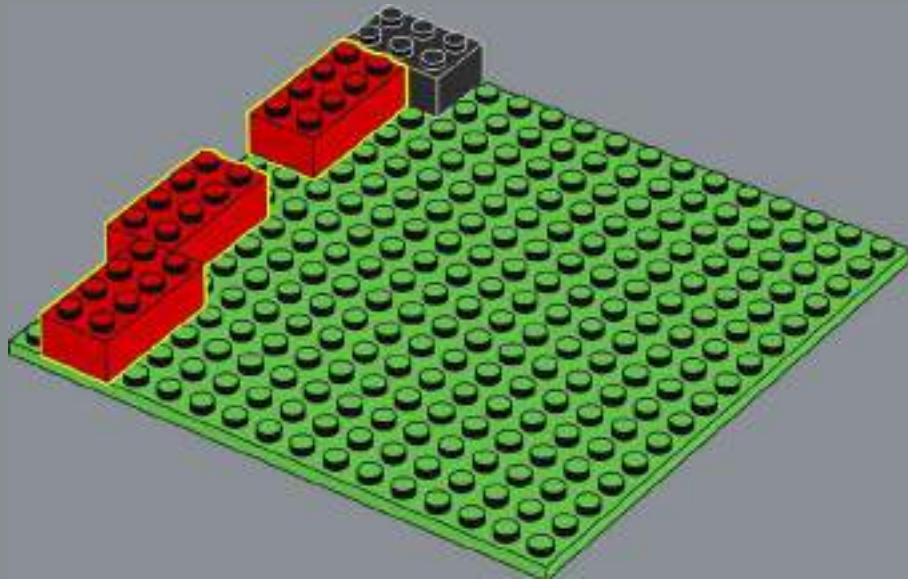

69

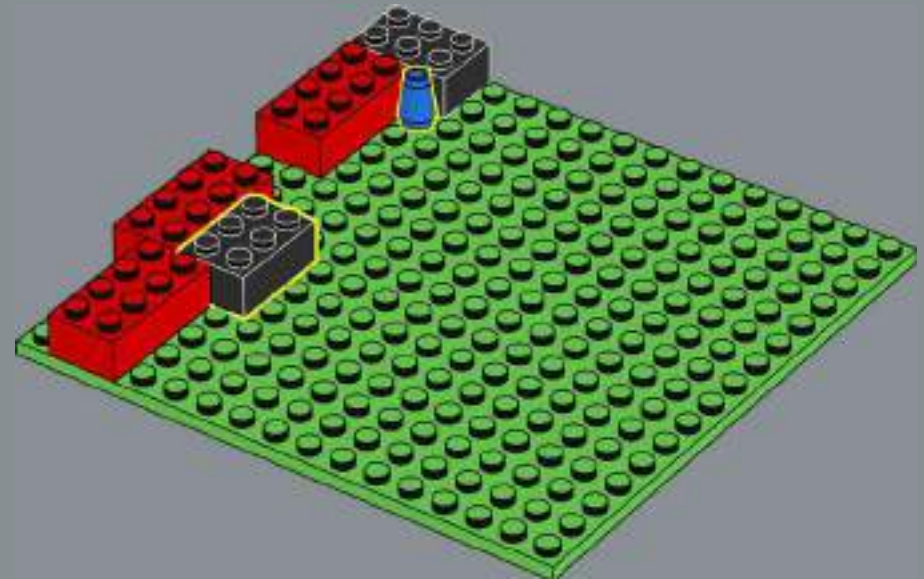



70

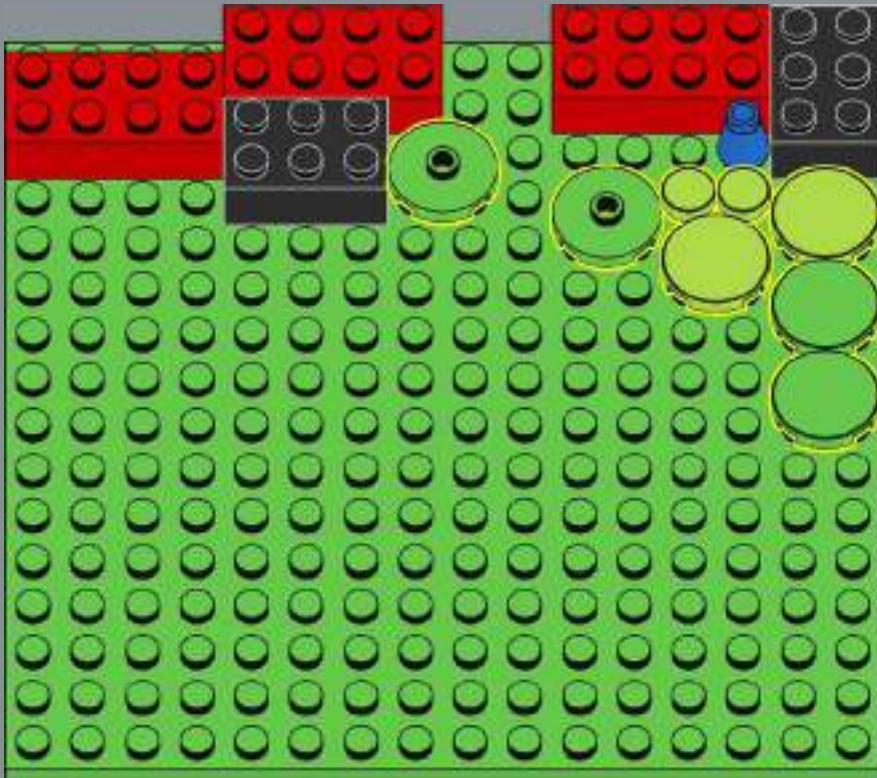

71

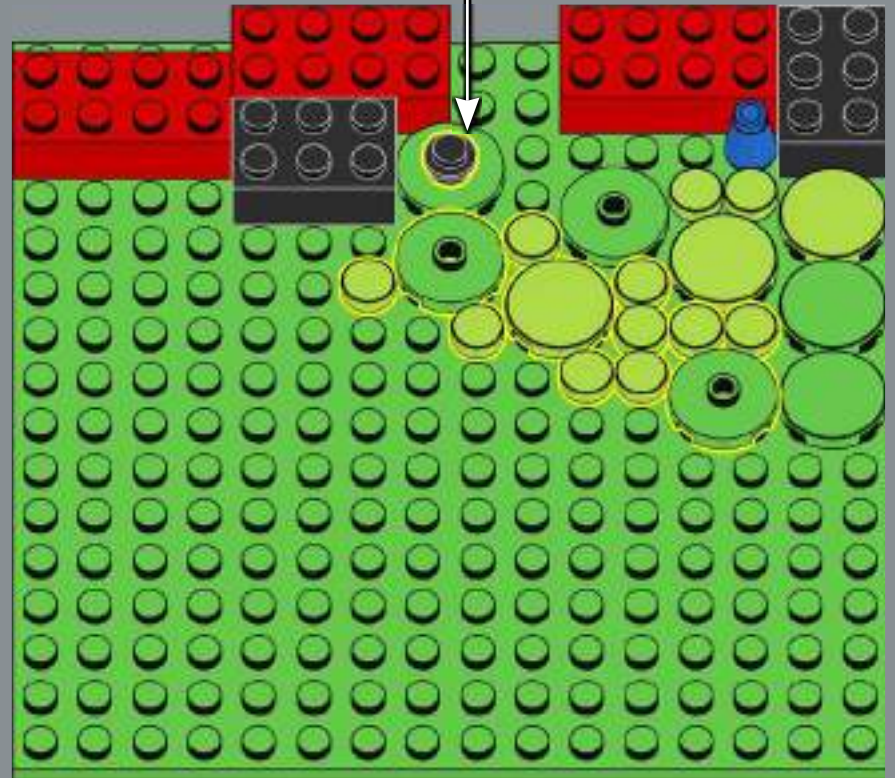



72

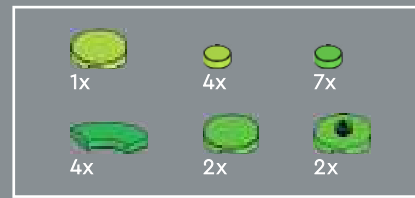
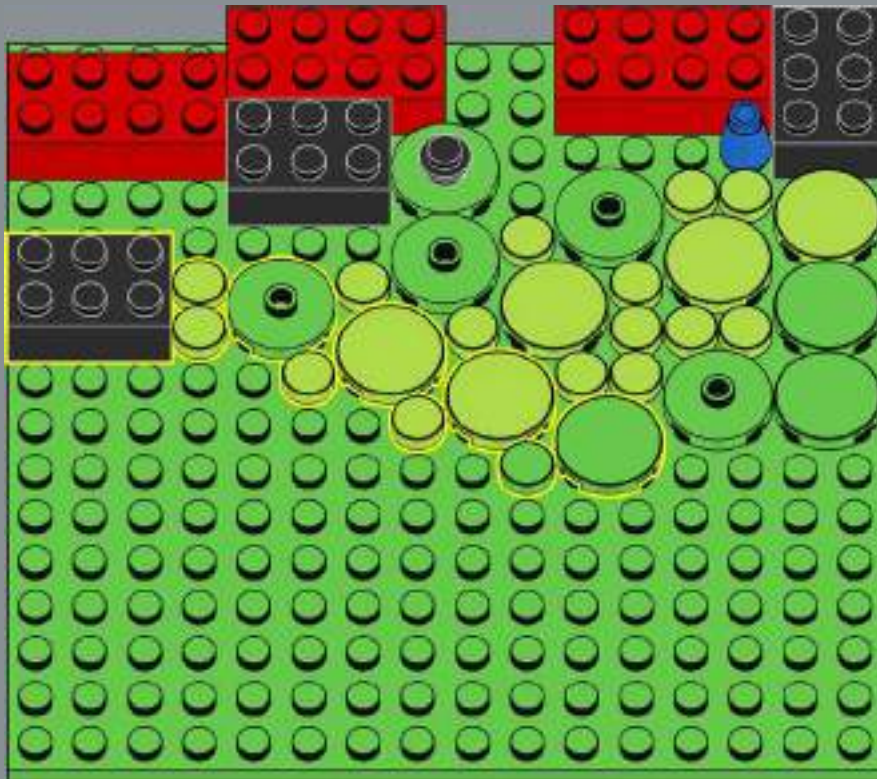

73

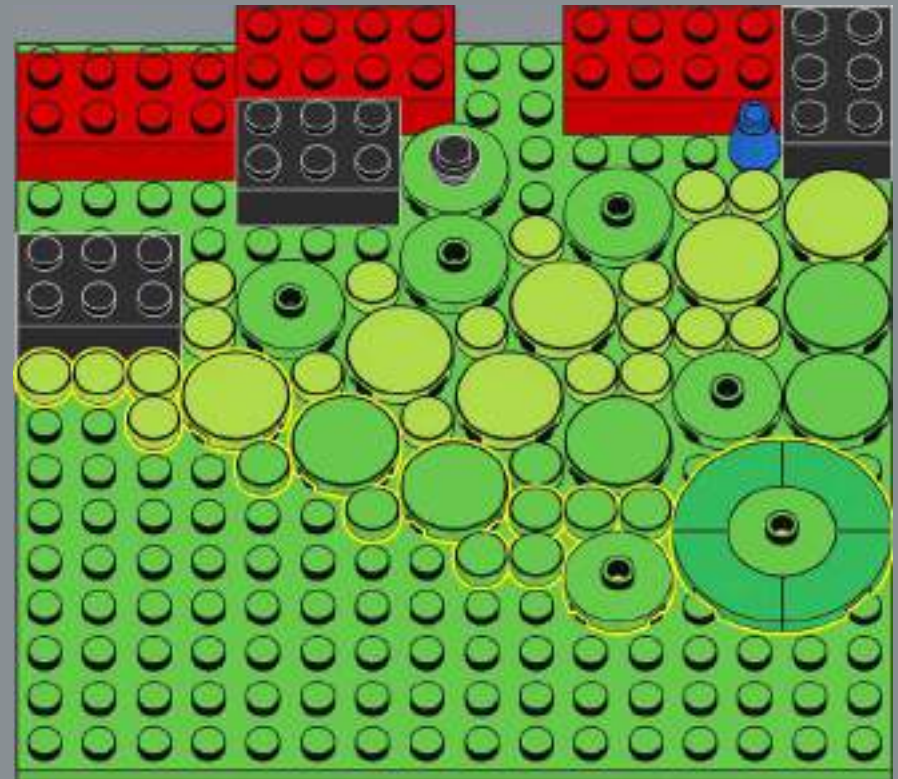



74

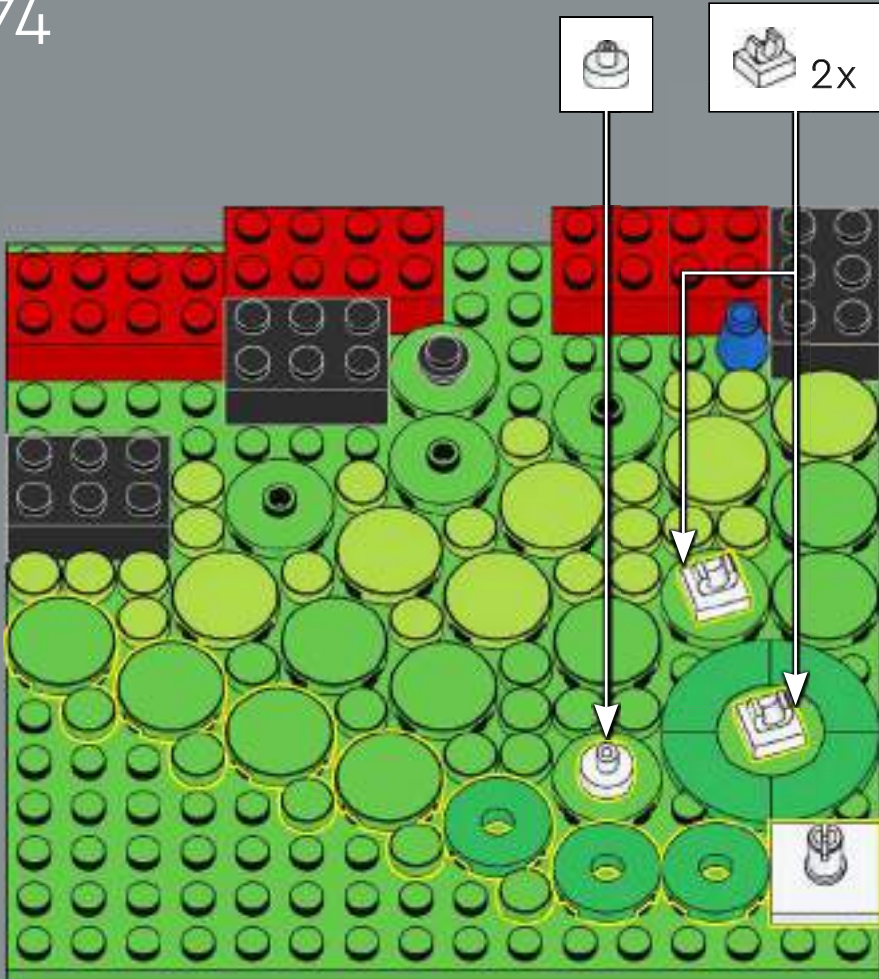

75

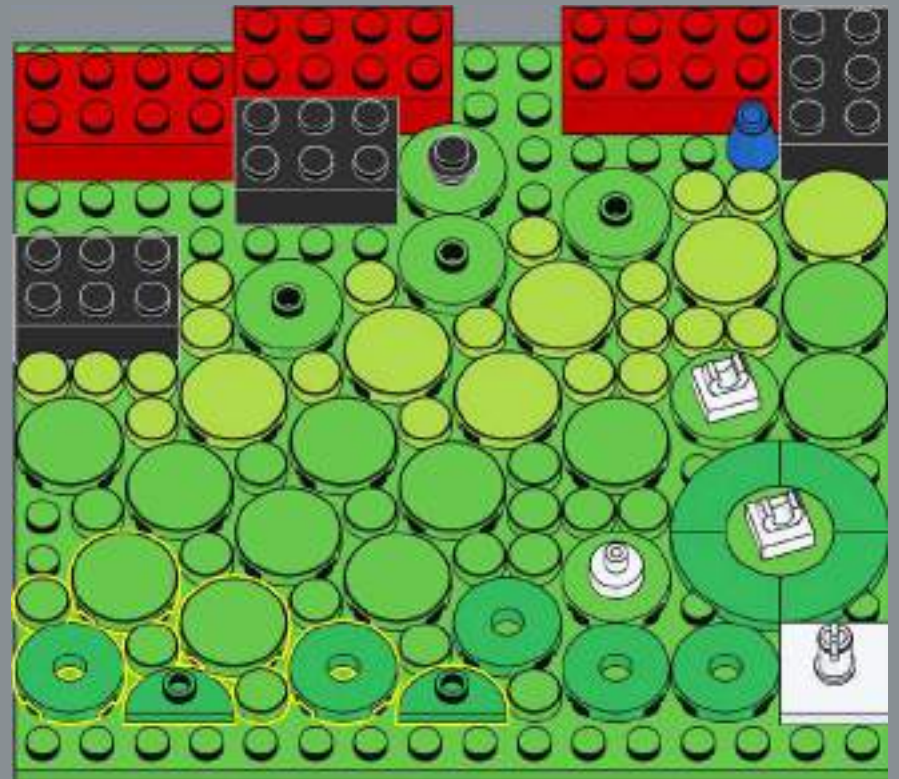

76

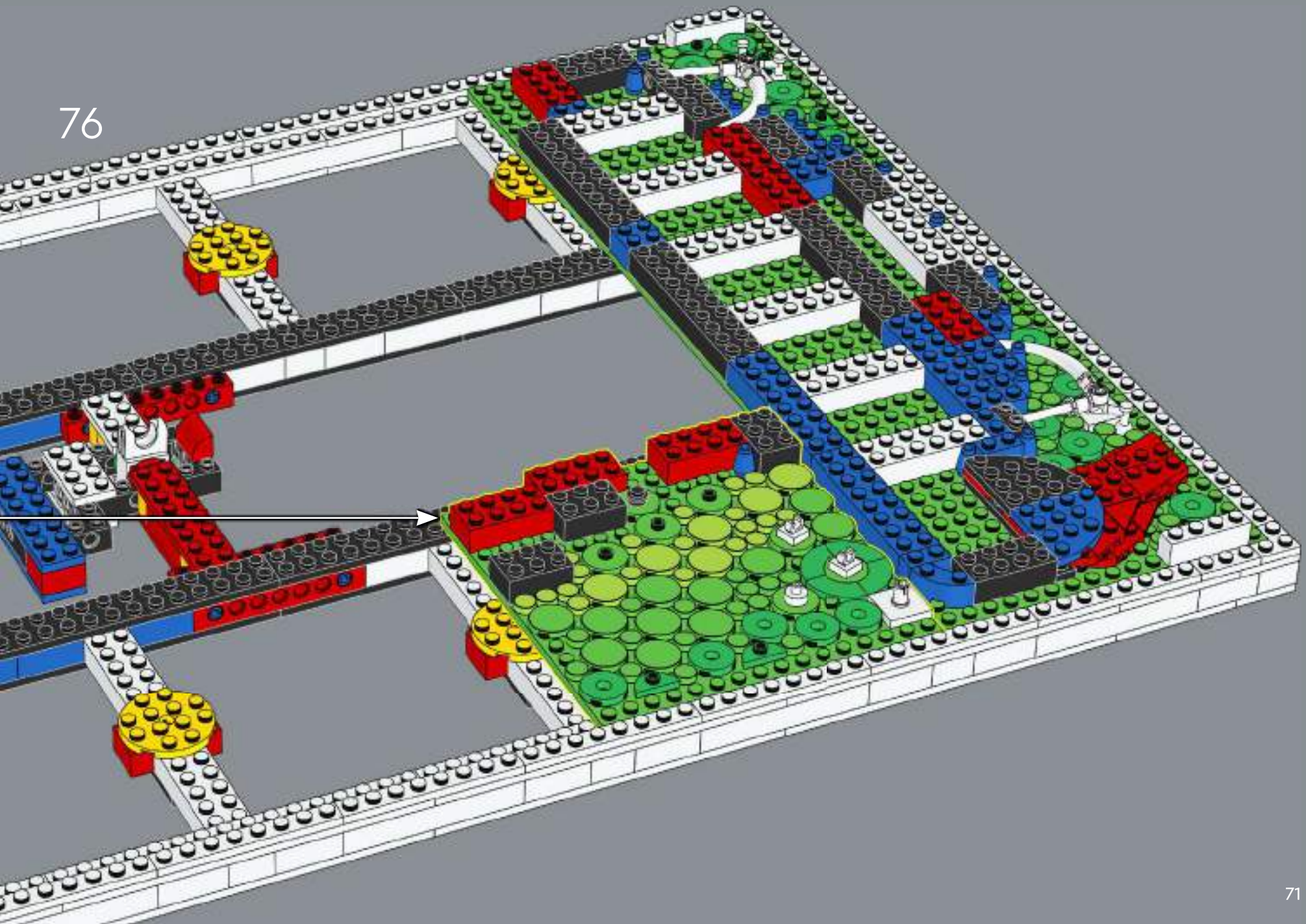



77

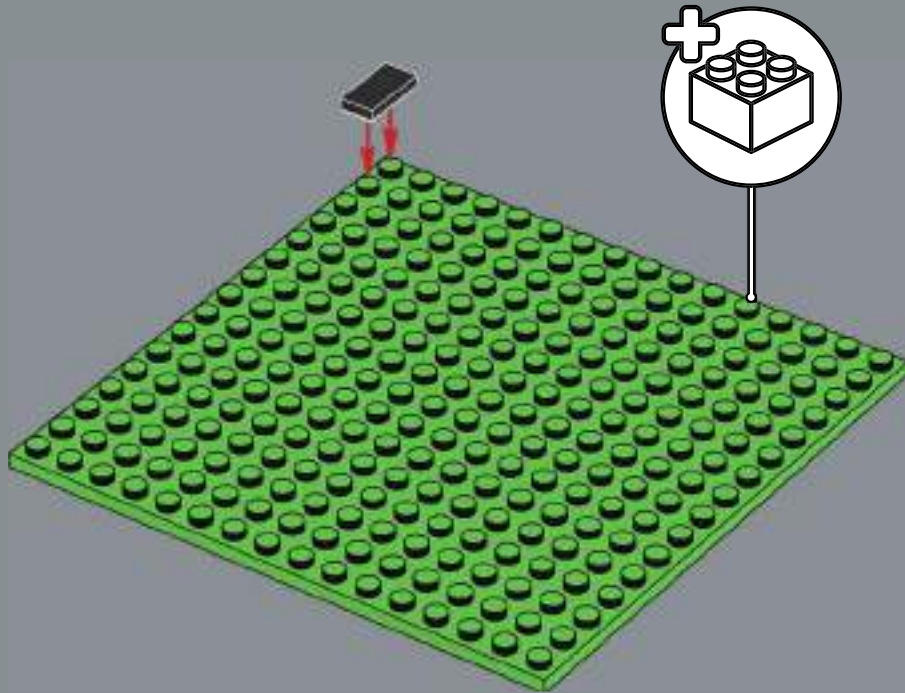

78

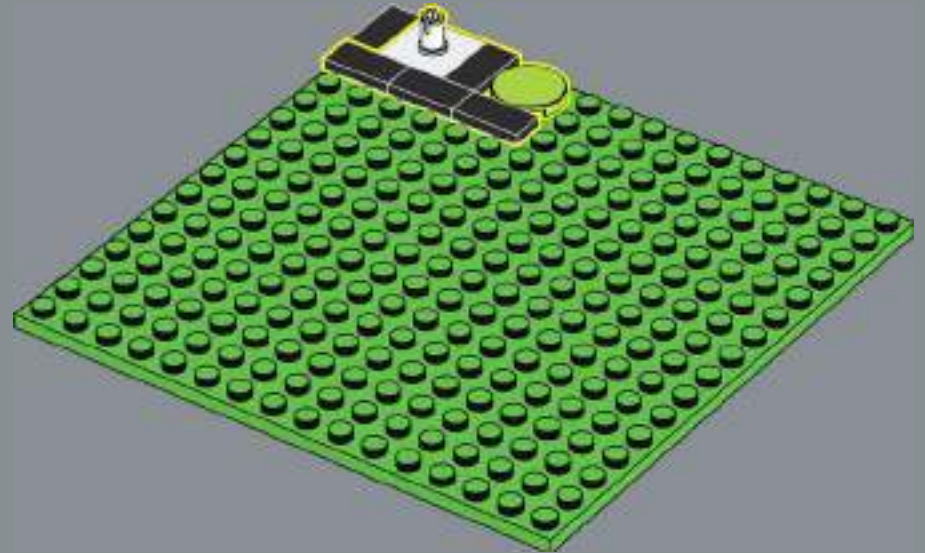



79

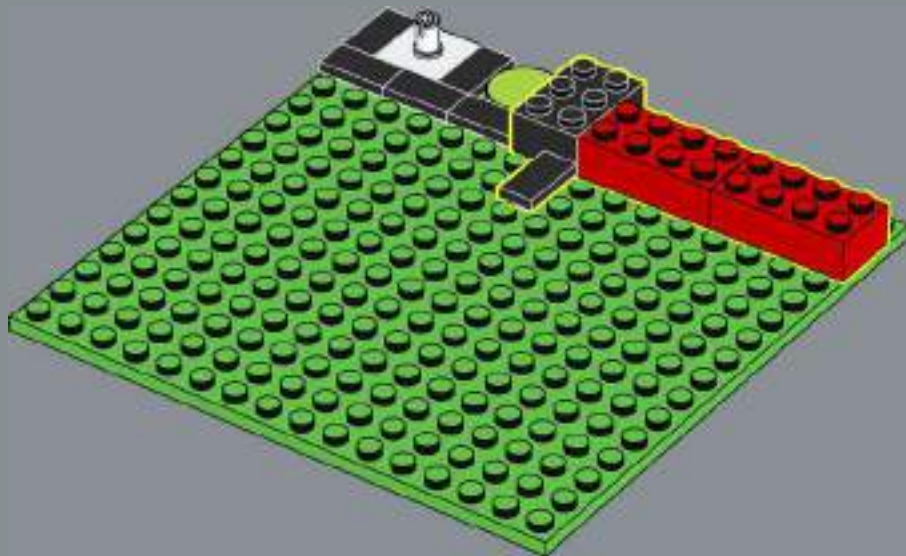

80

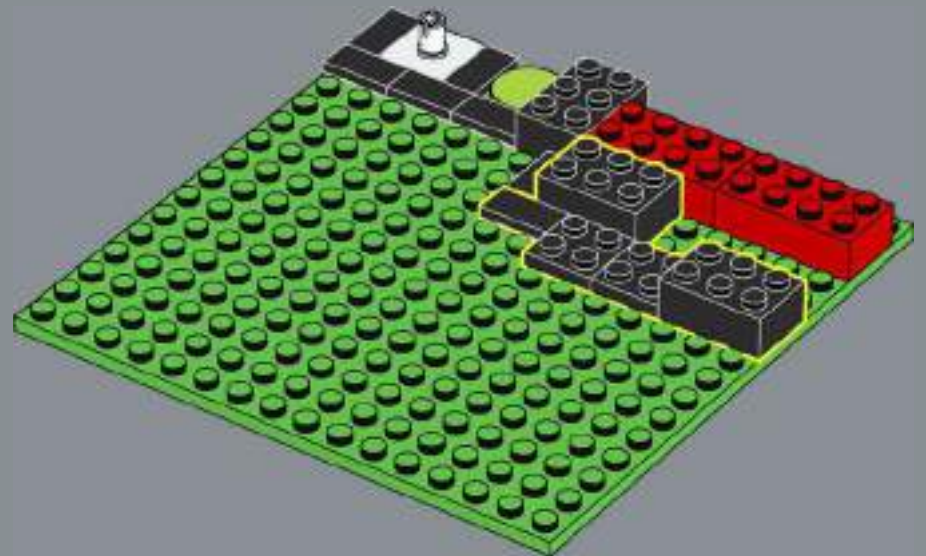



83

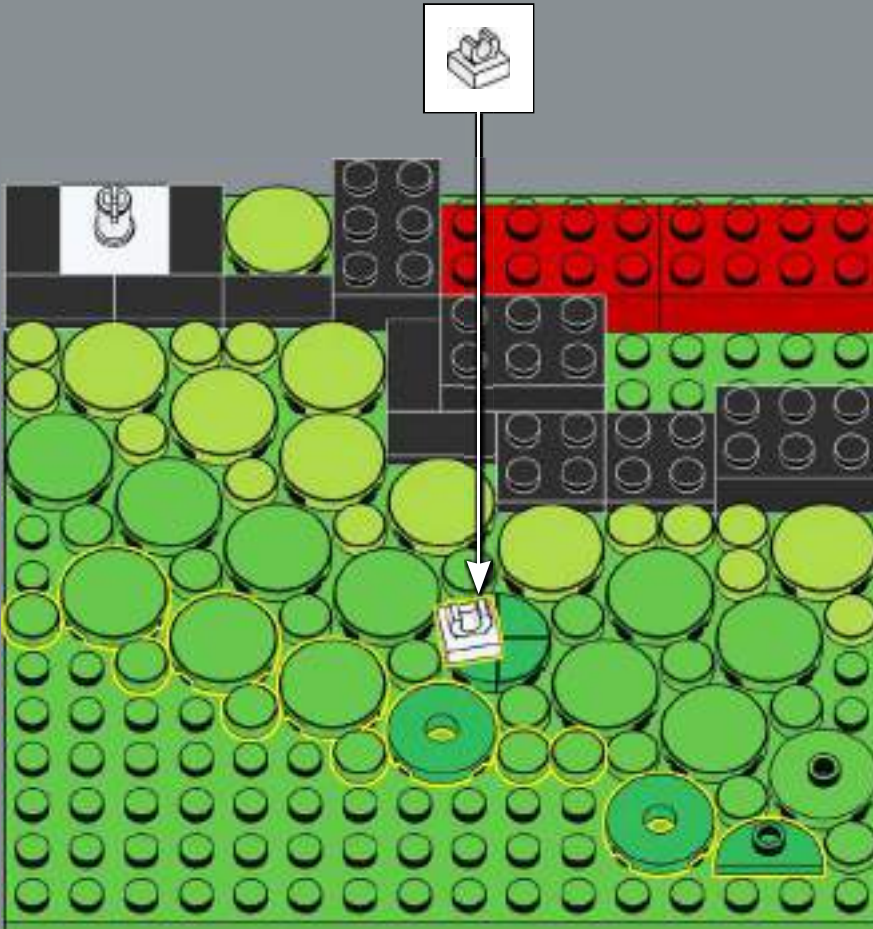

84

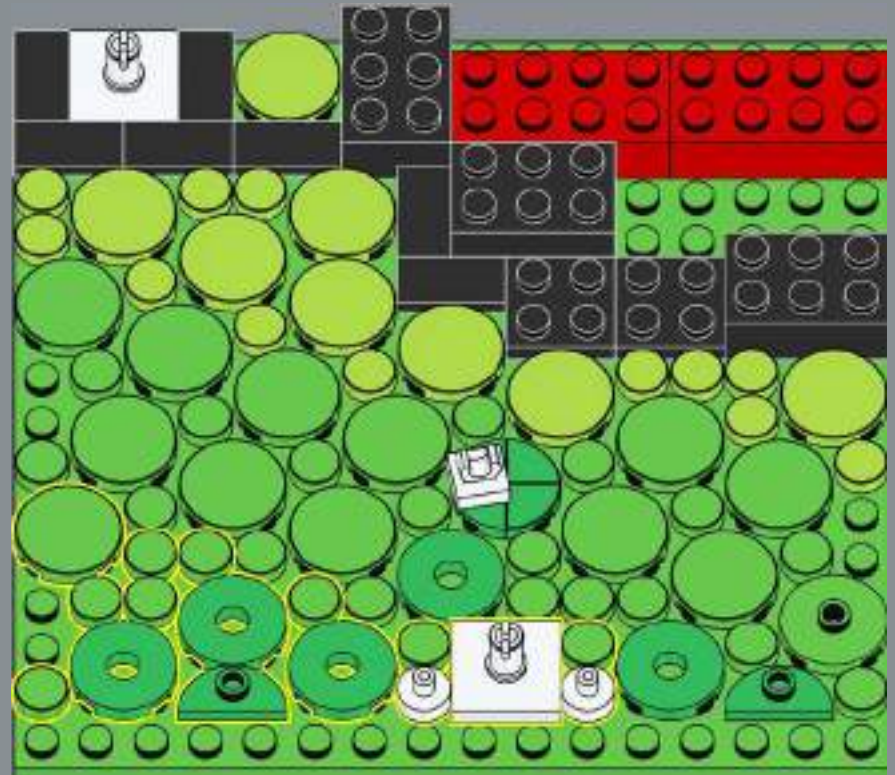

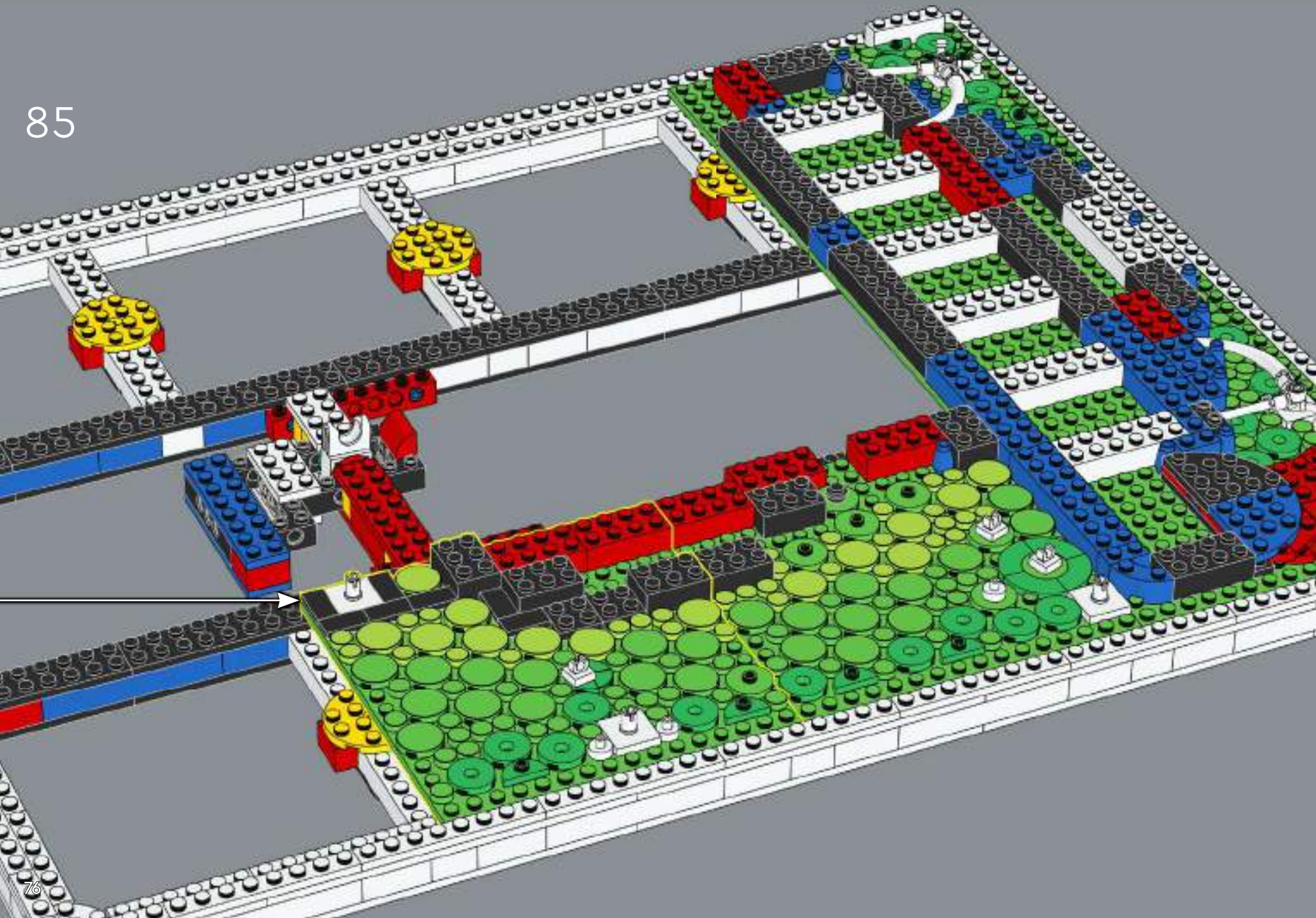



86



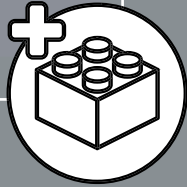
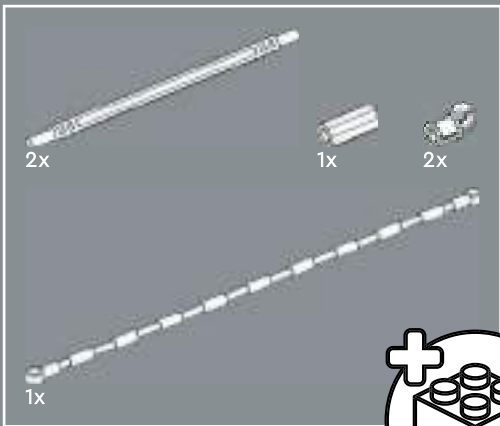

87

Spider-Man has spent long hours practicing the operation of his web... The terrific teenager can now use it in many different ways!
- Thwip!

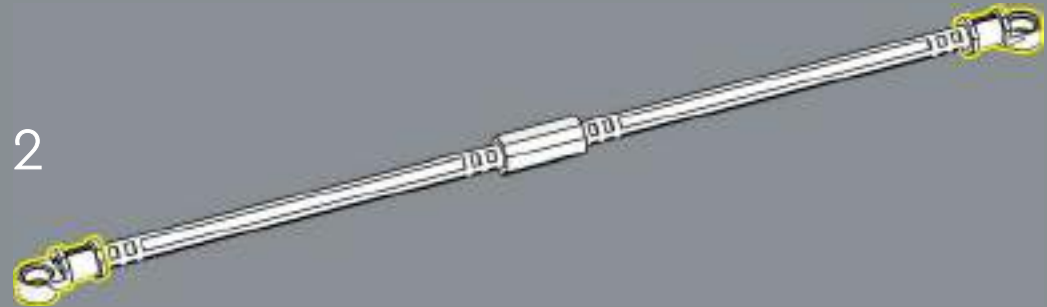
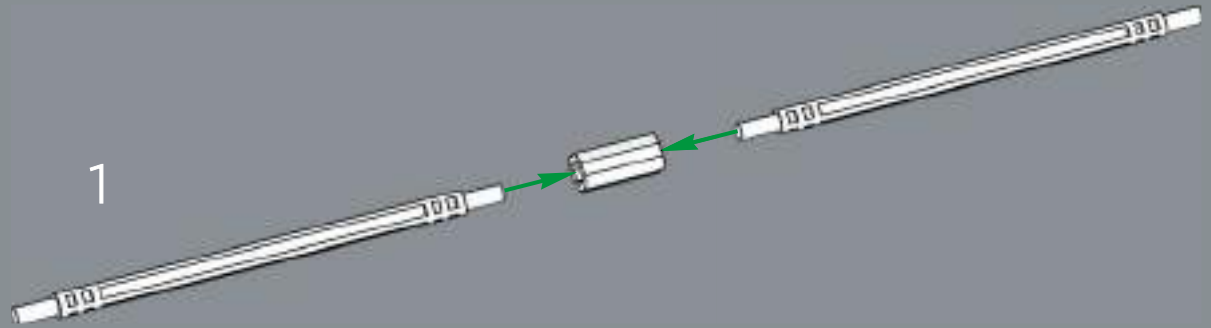

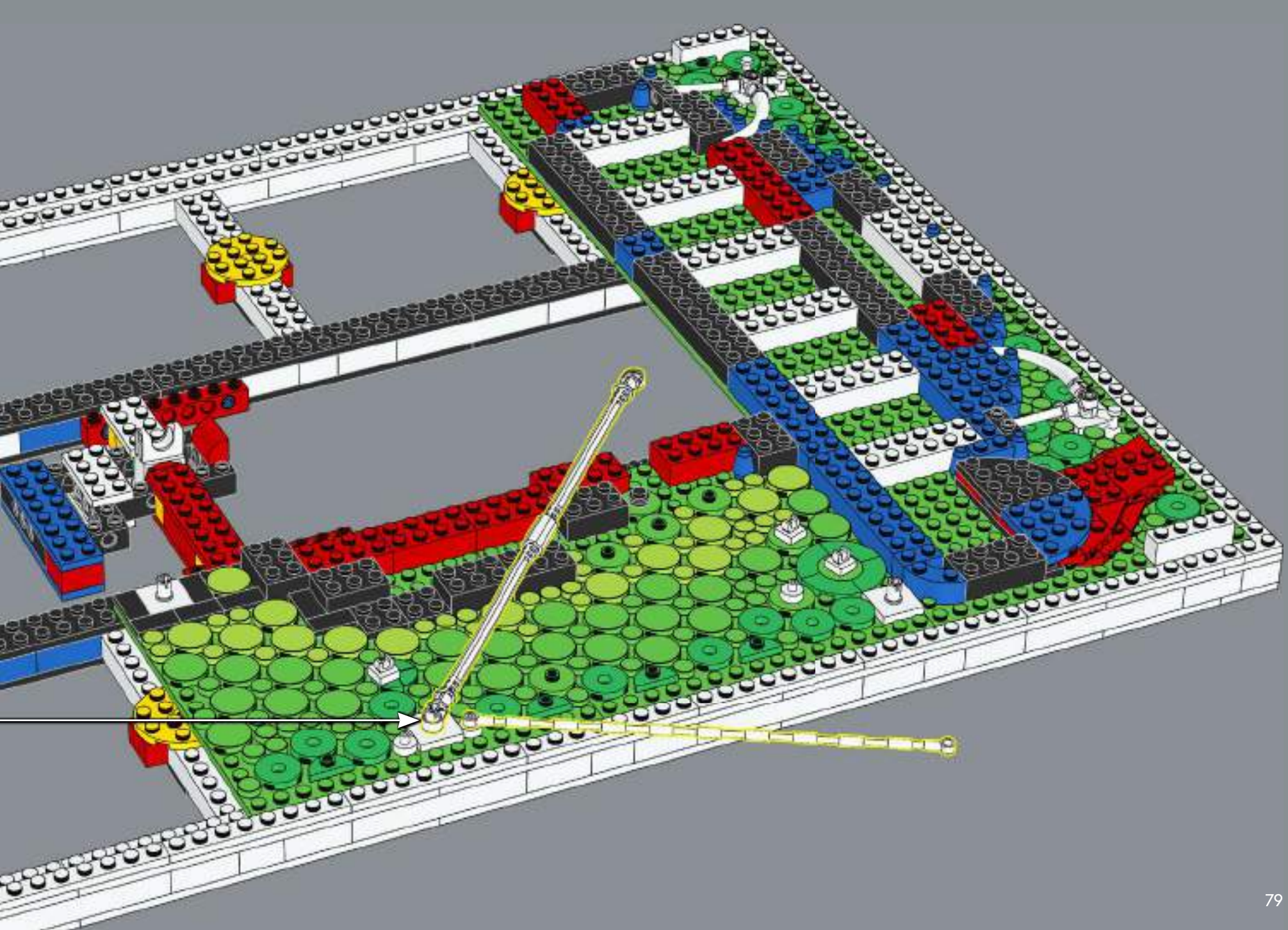



89

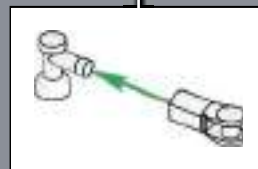
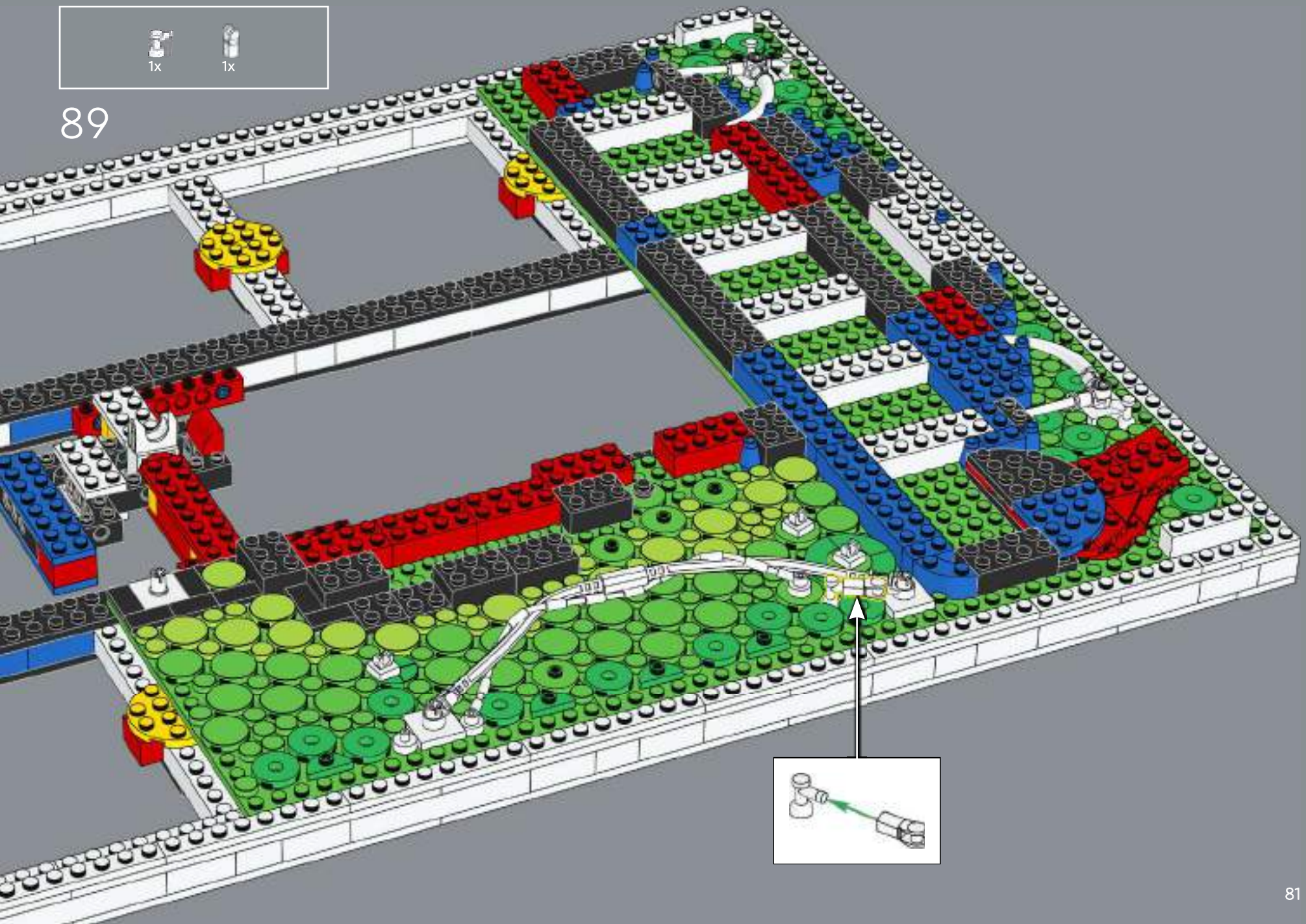

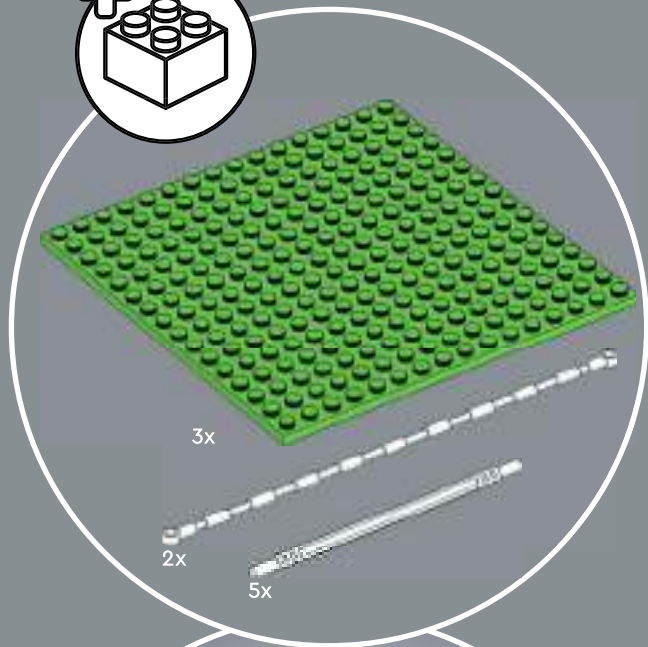
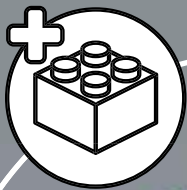

90

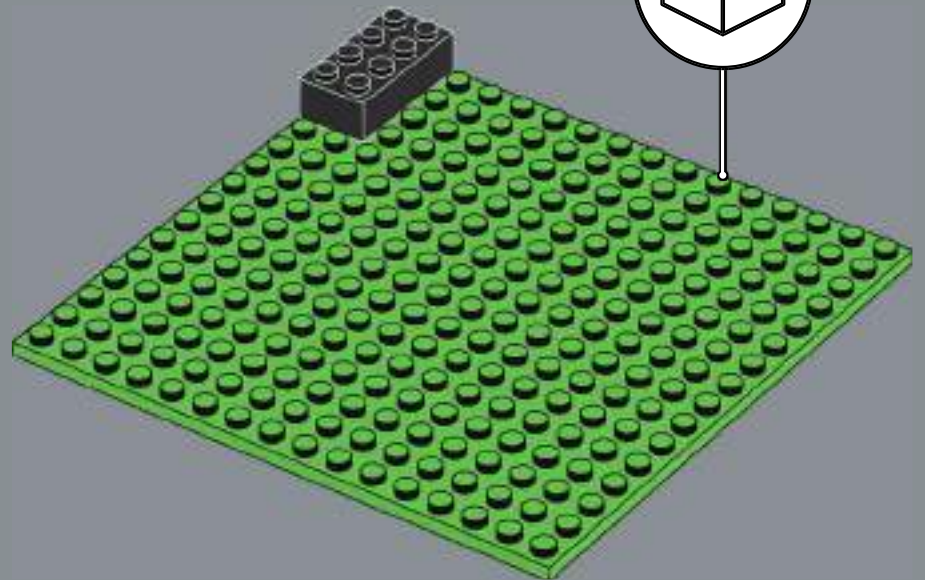
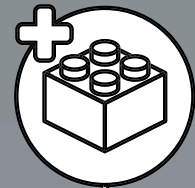



91

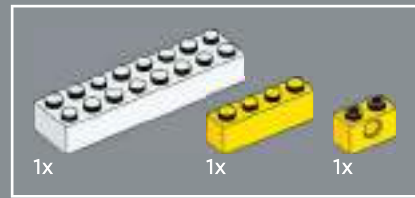
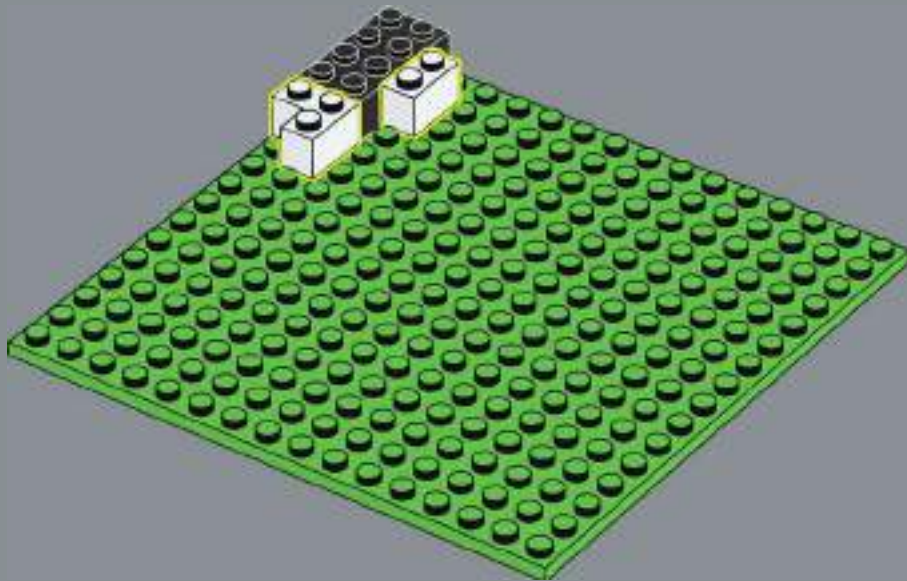

92

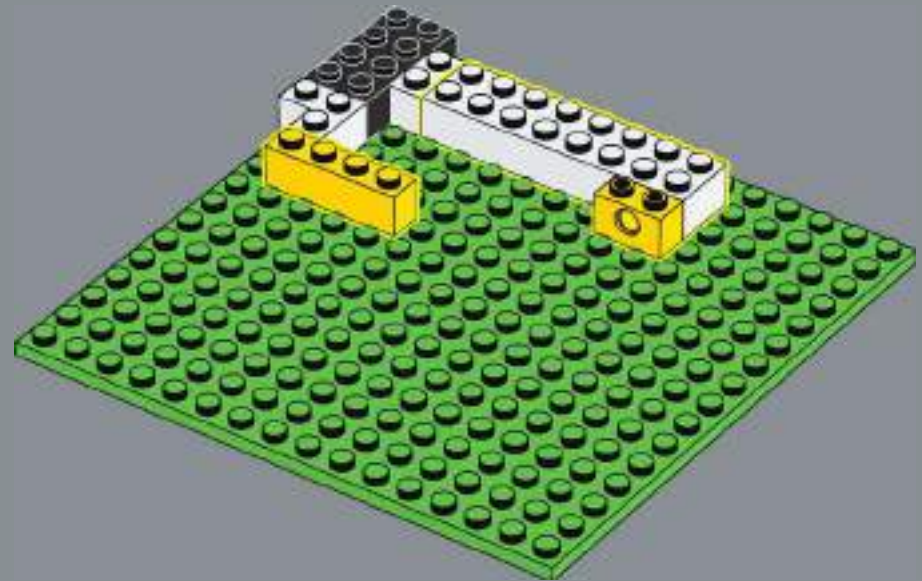

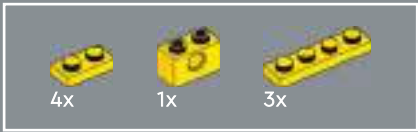

93

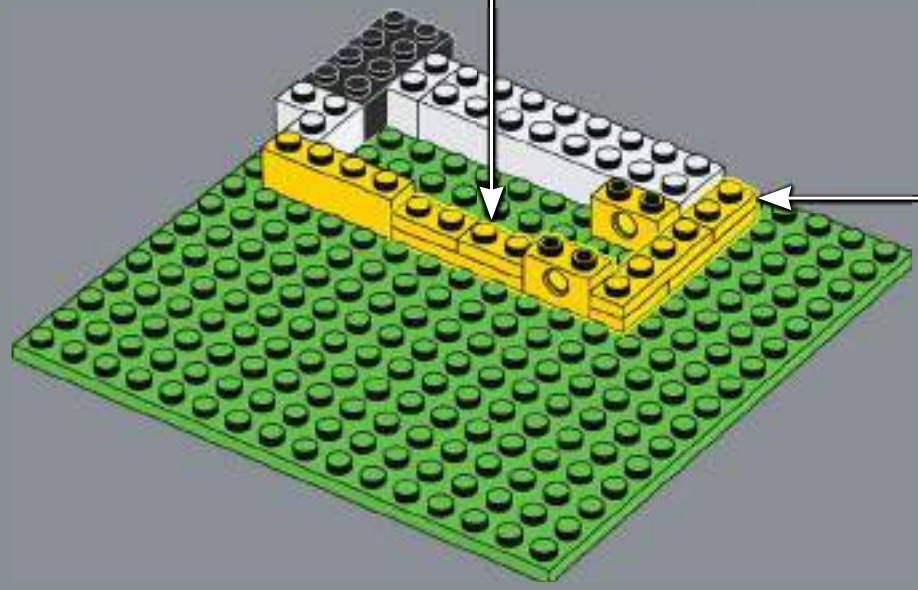
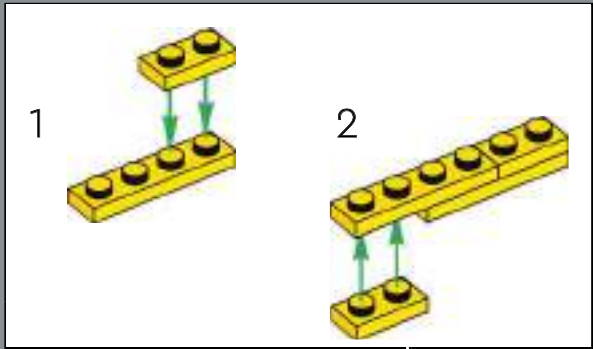
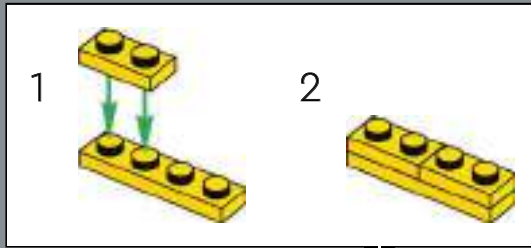

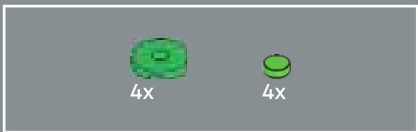

96

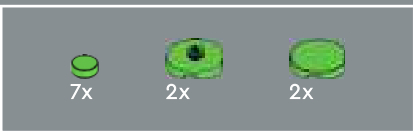
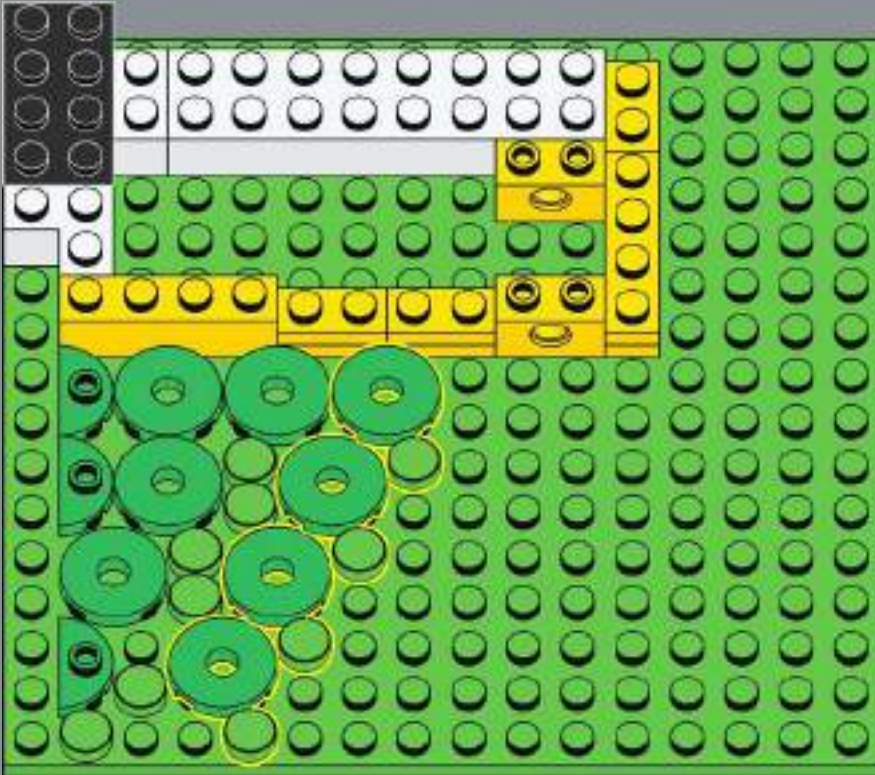

97

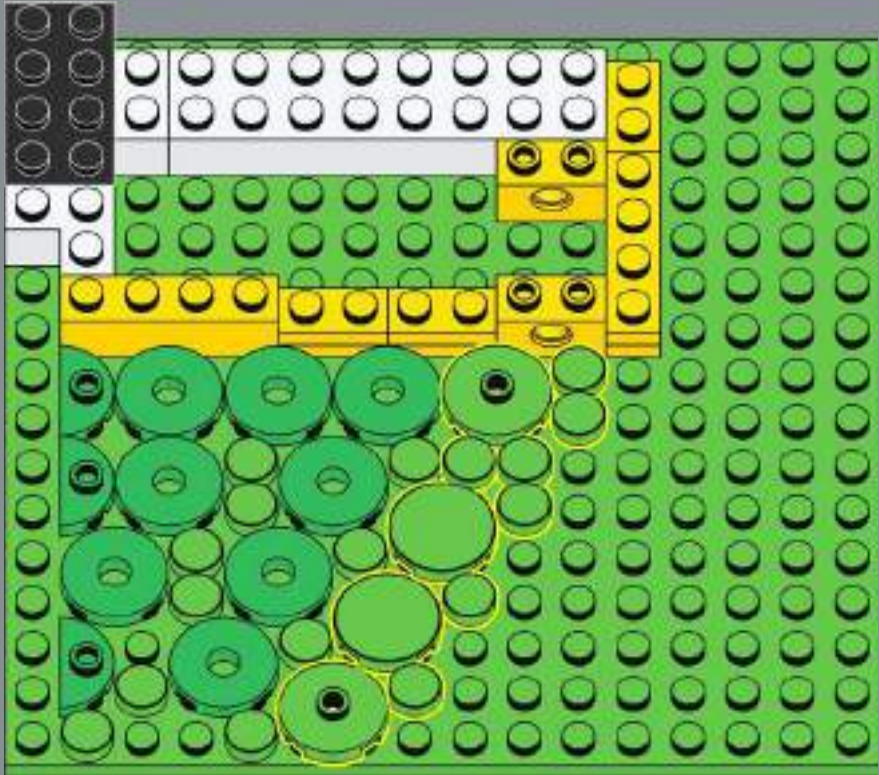



98

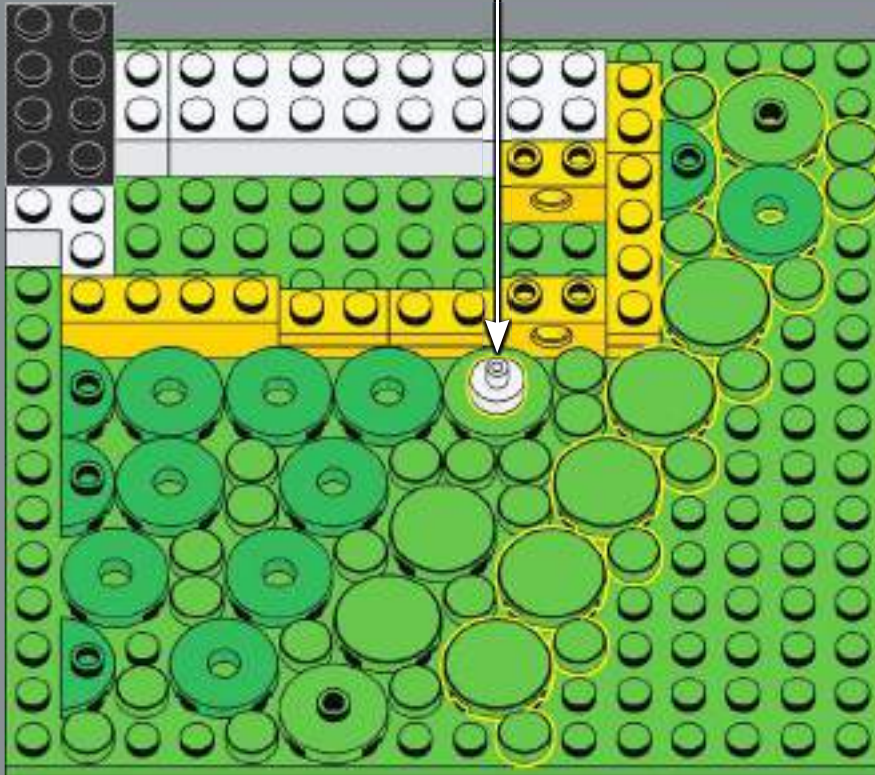

99

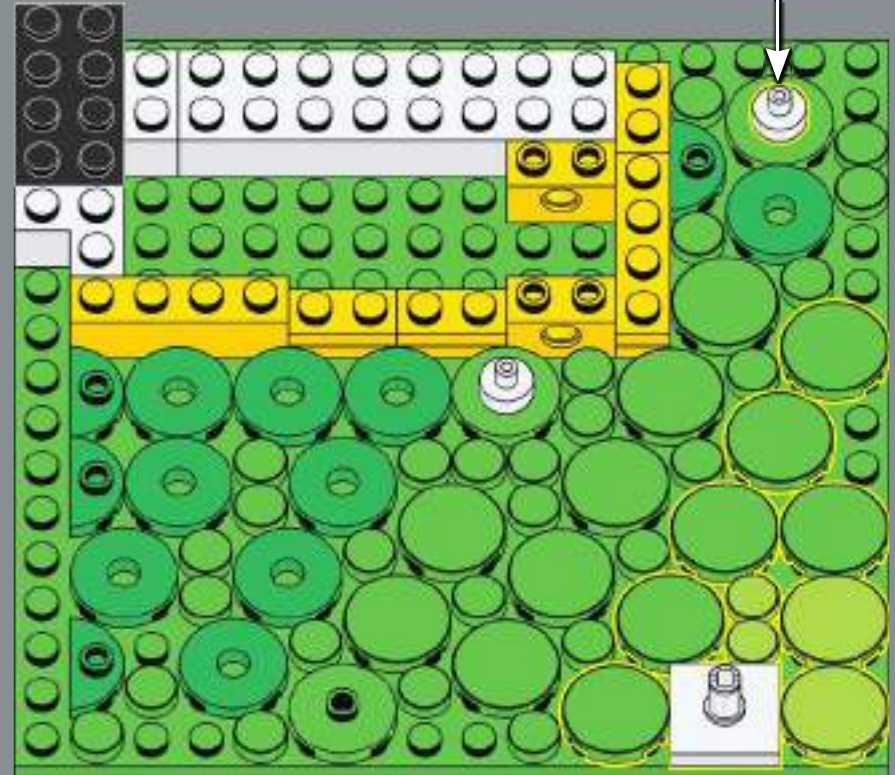



100

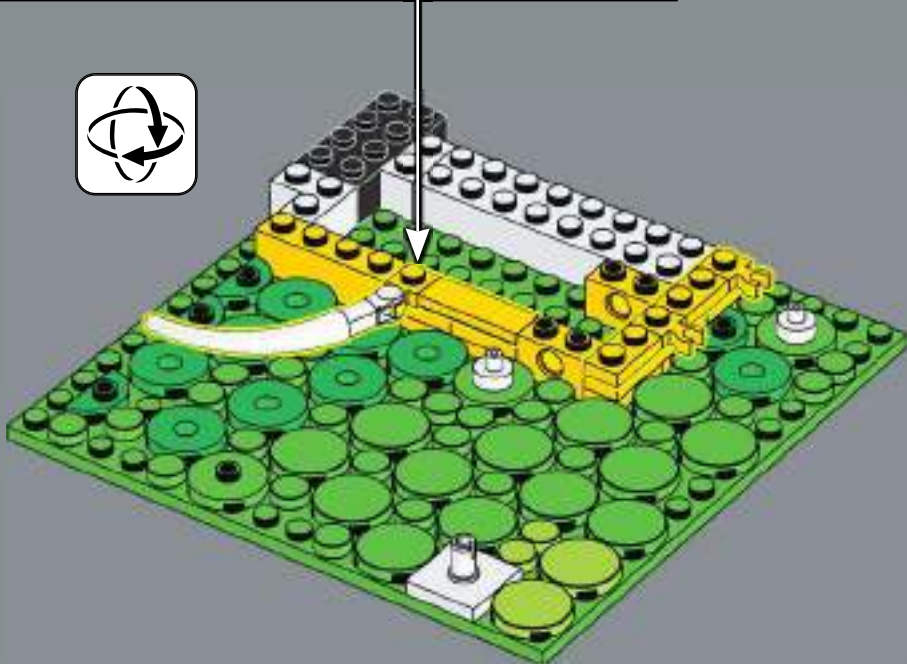
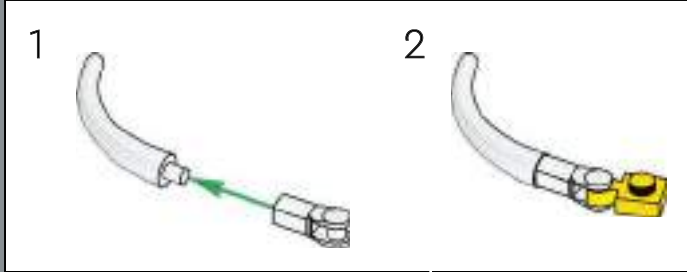

101

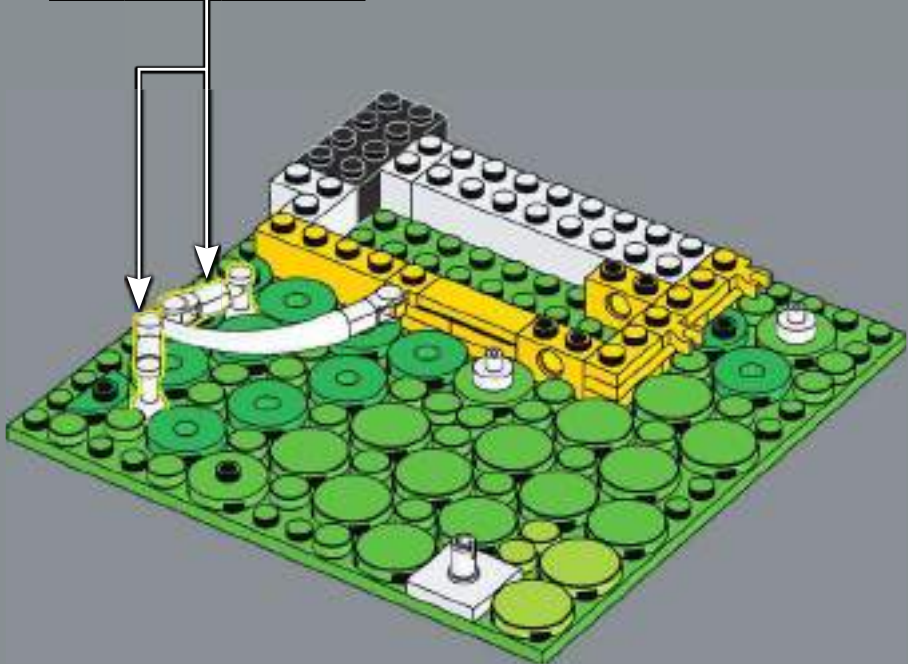
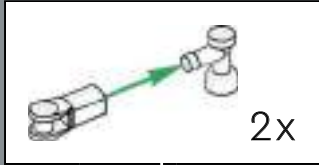

102

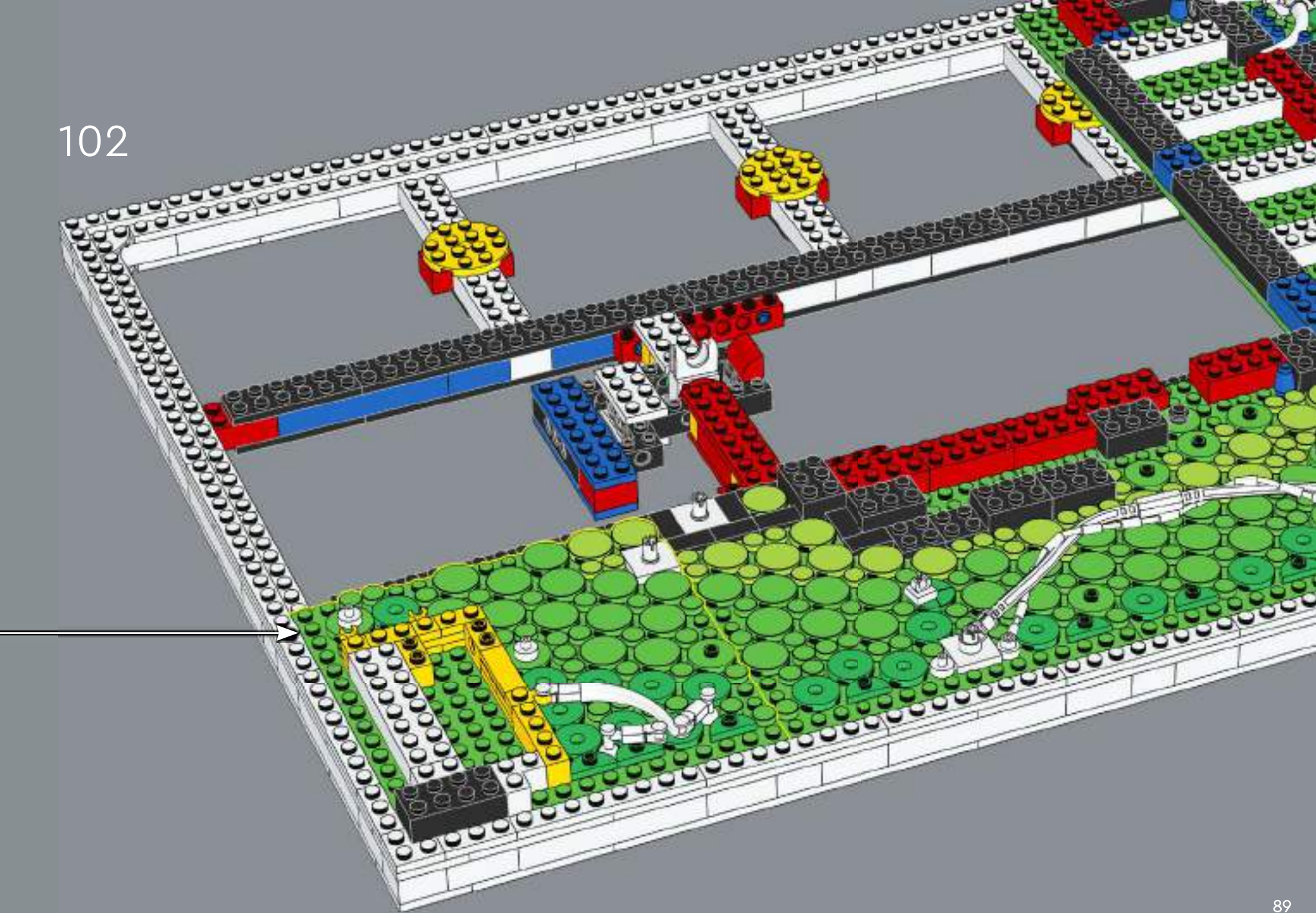



103



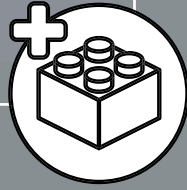
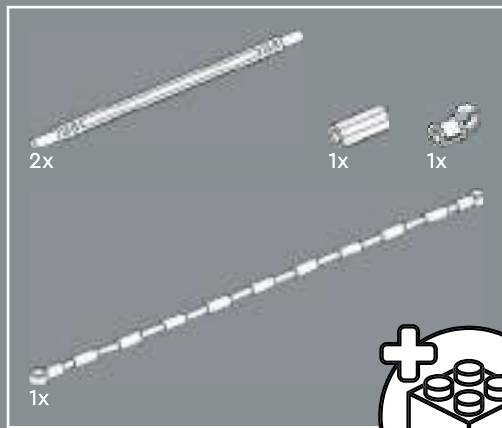

104

1

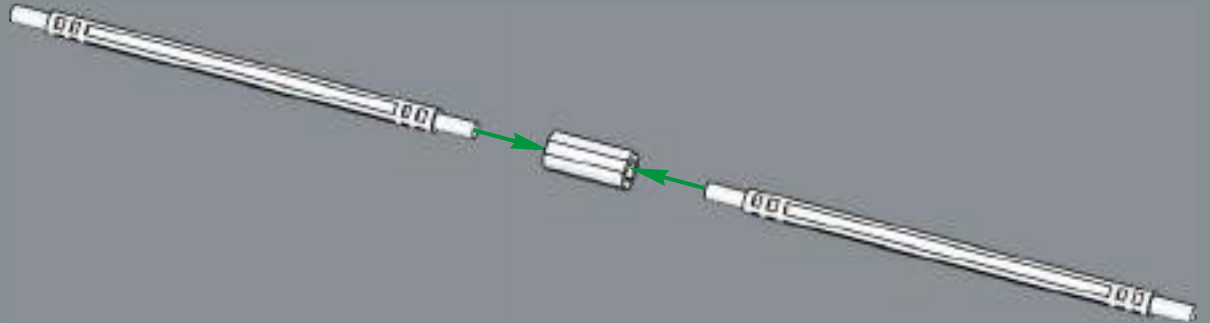

2

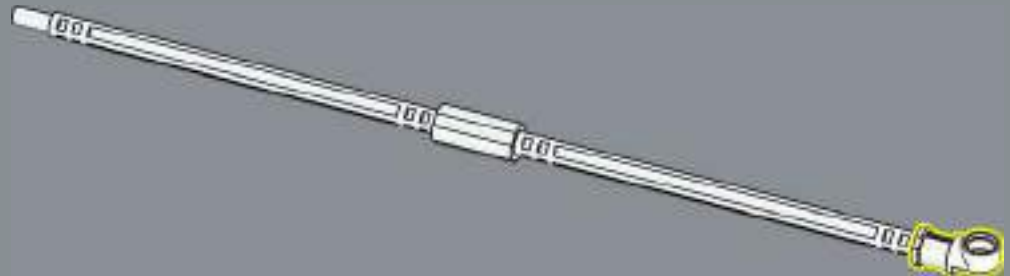



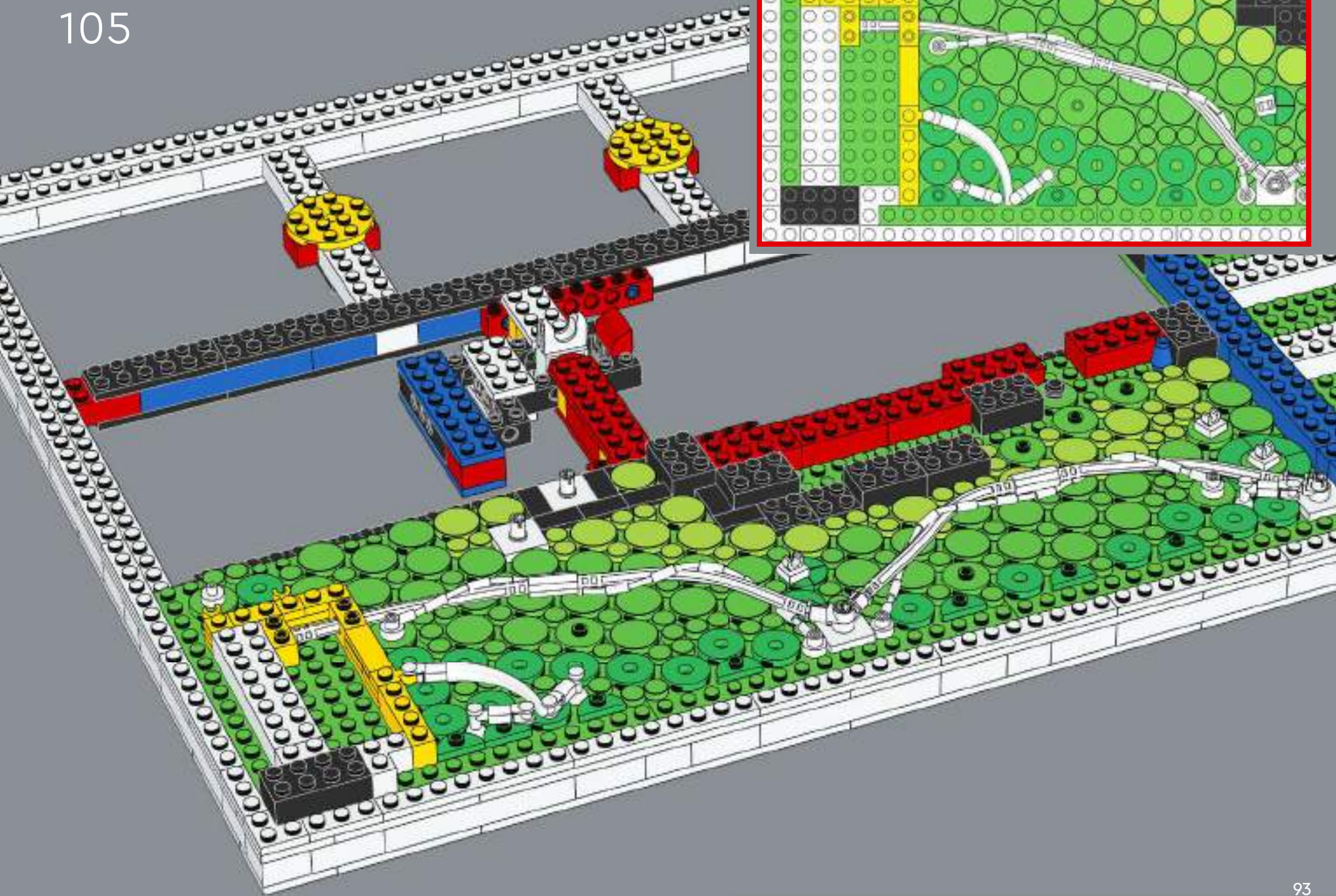

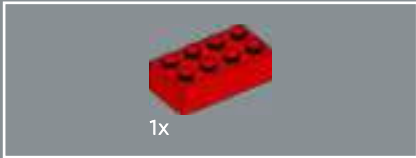
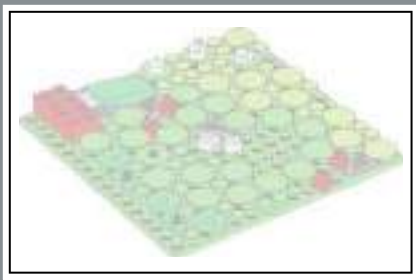

106

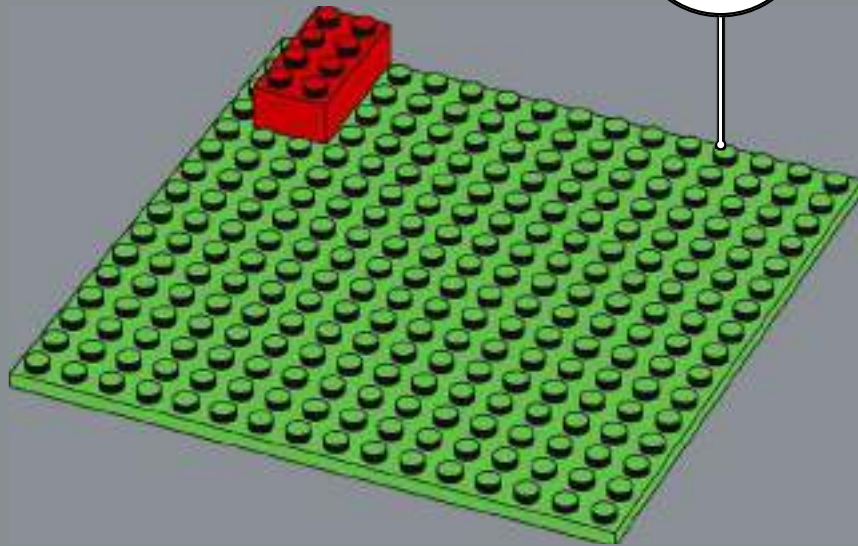
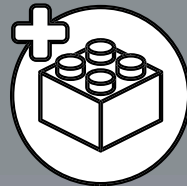

107

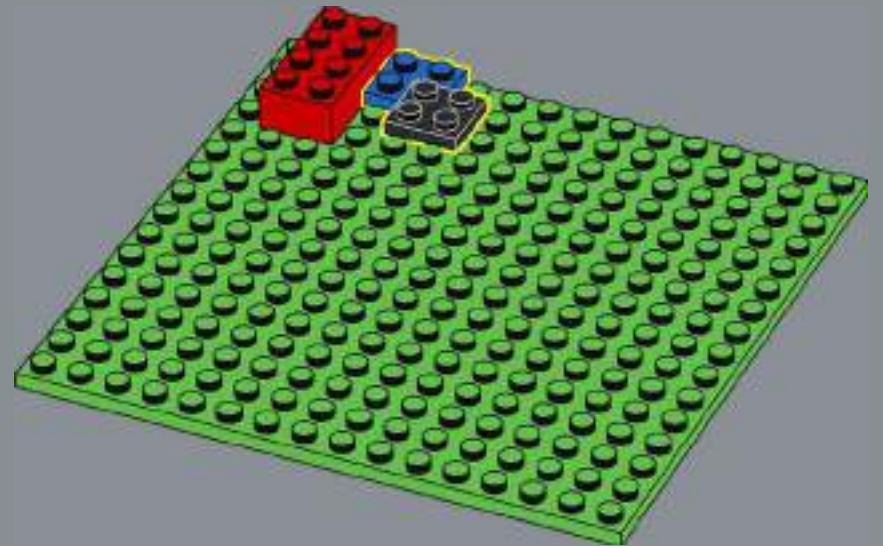



108

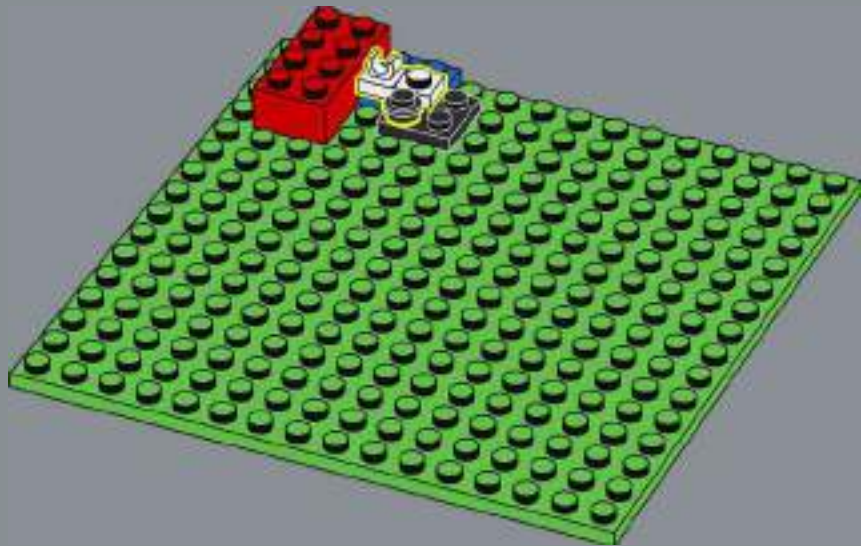

109

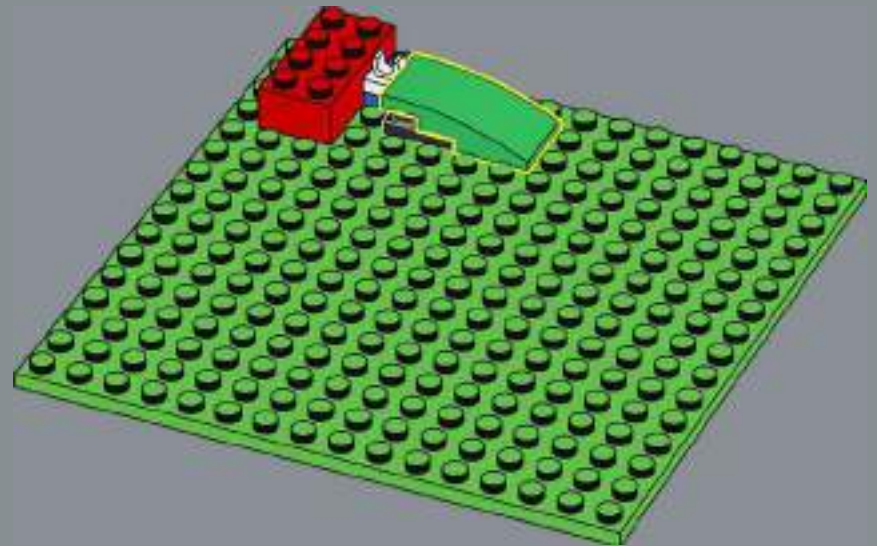



110

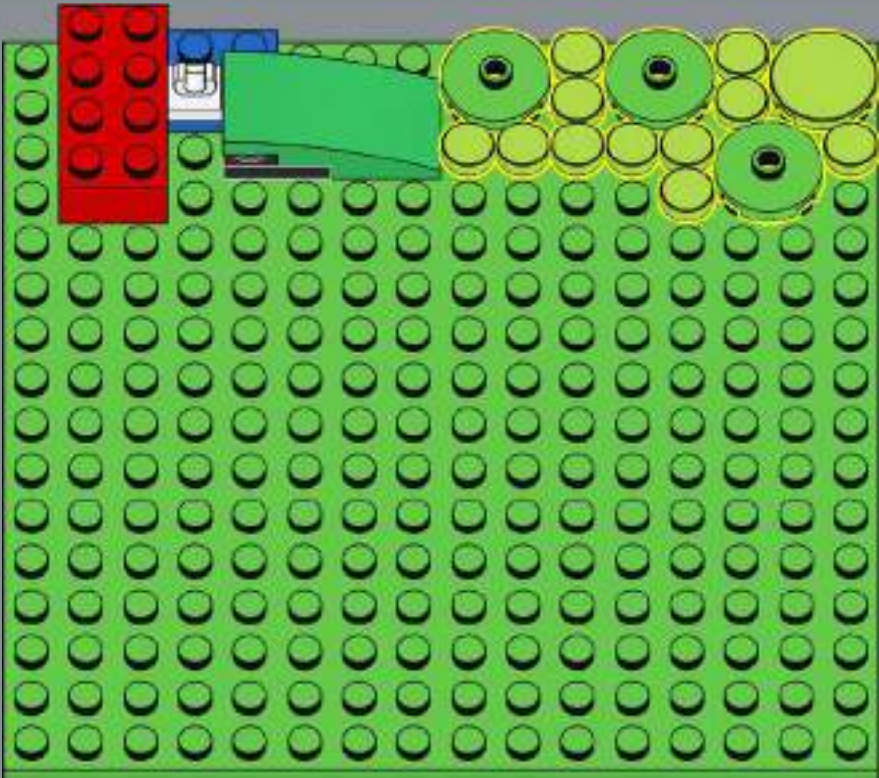

111

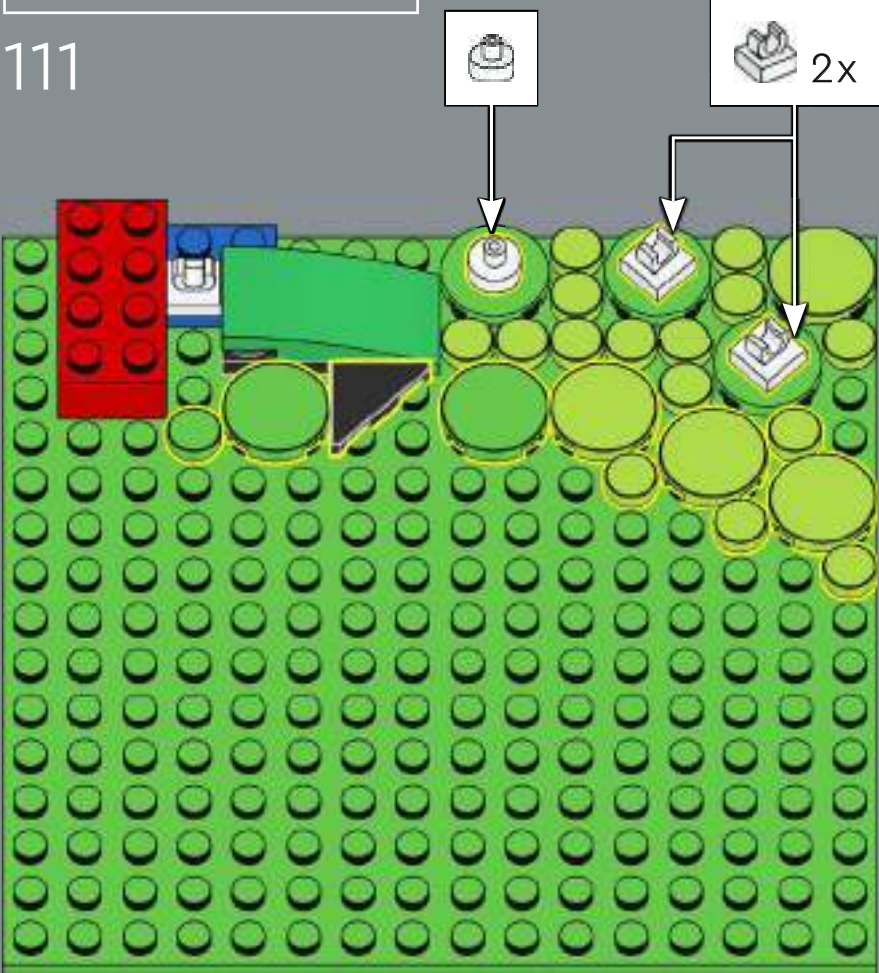



112

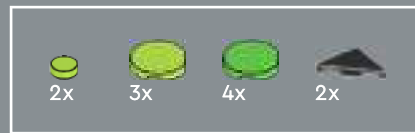
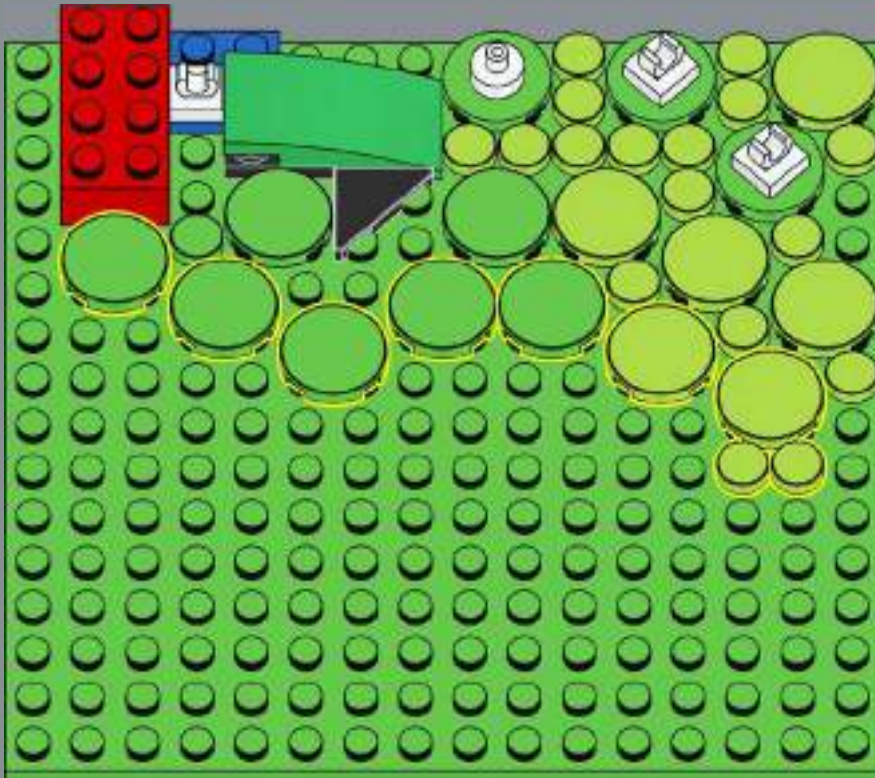

113

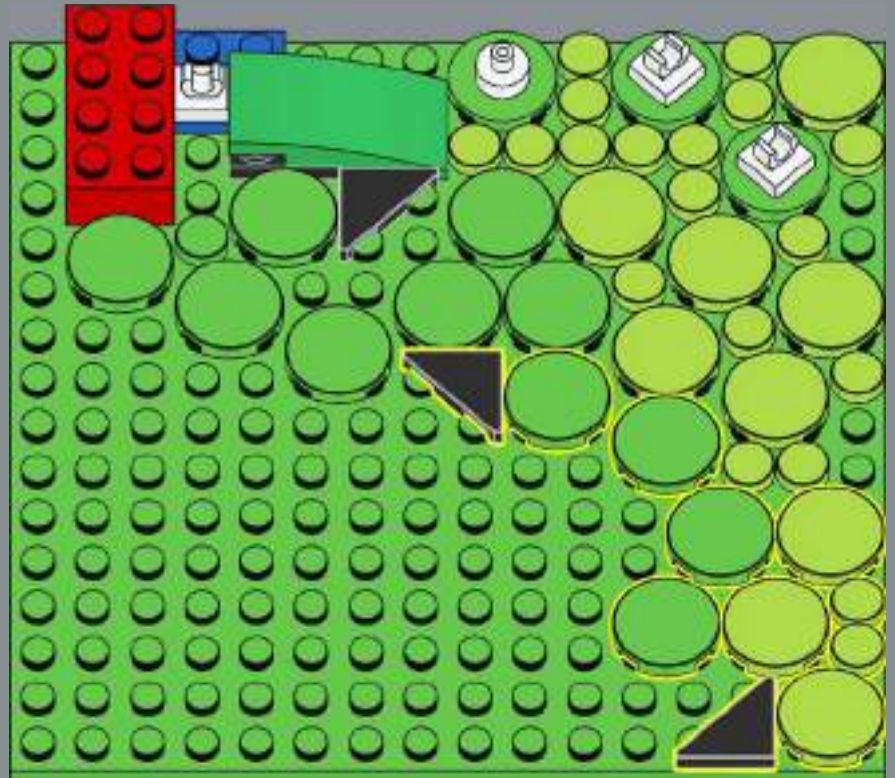

118



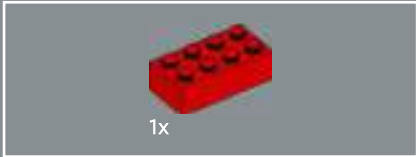

119

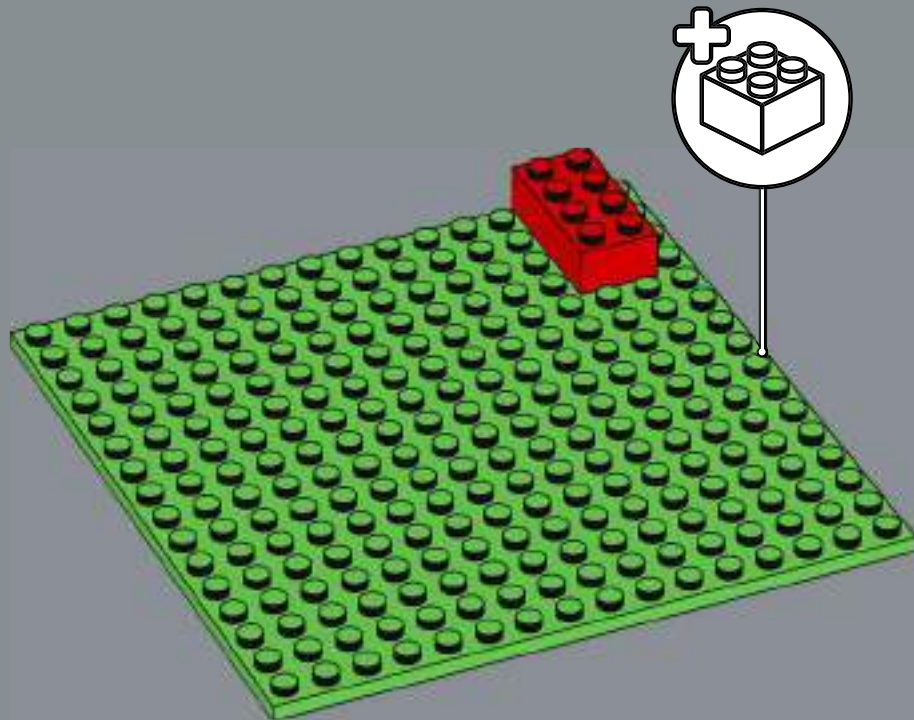

120

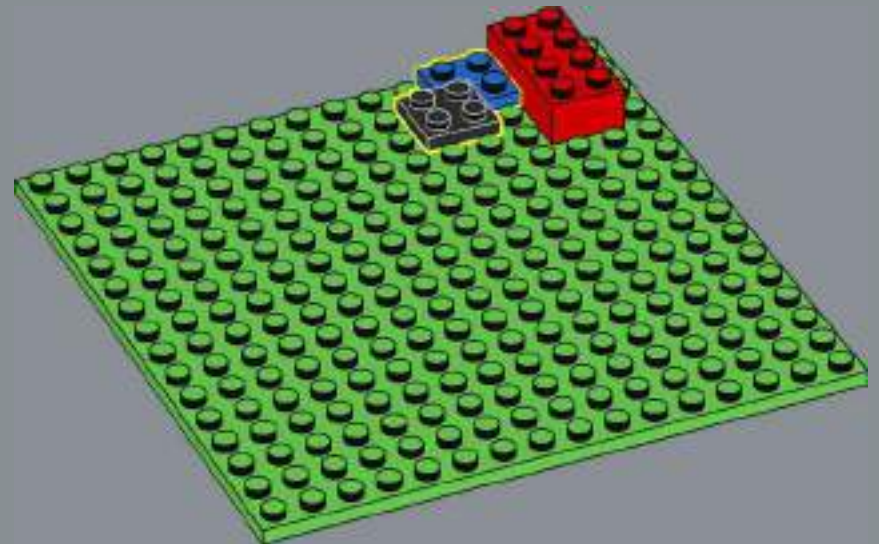



121

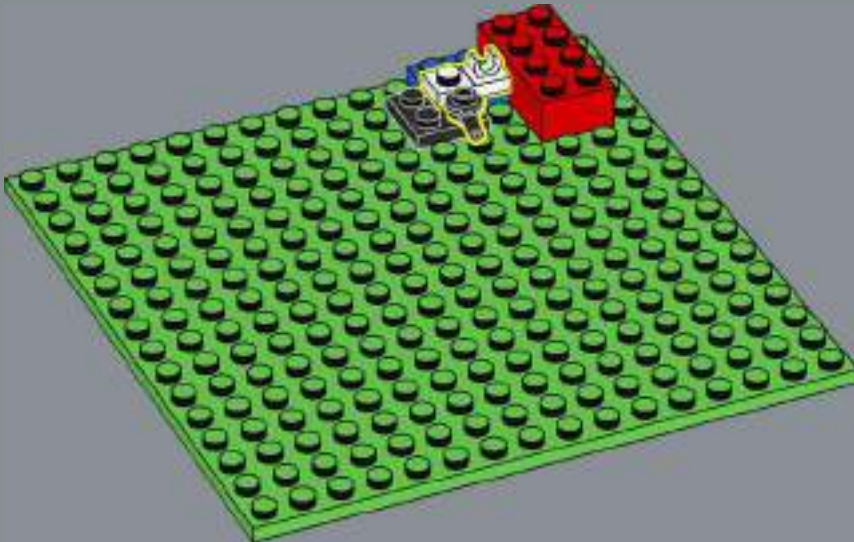

122

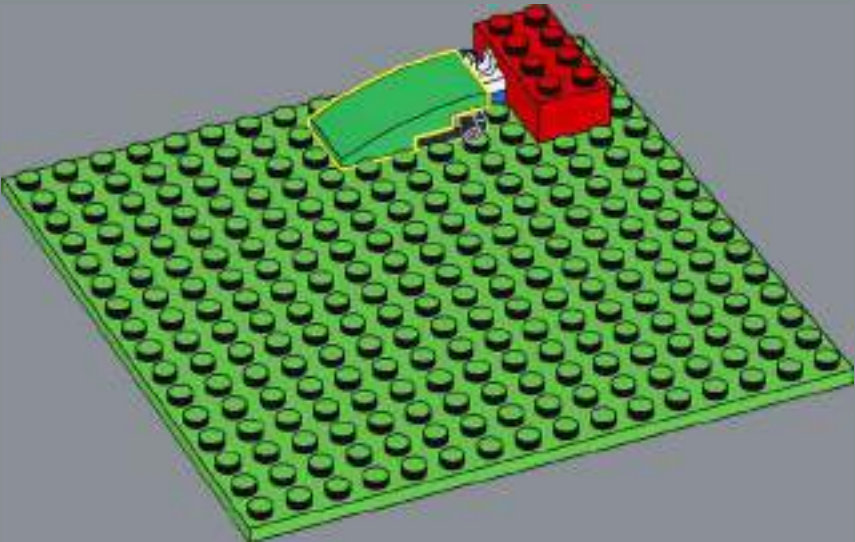



123

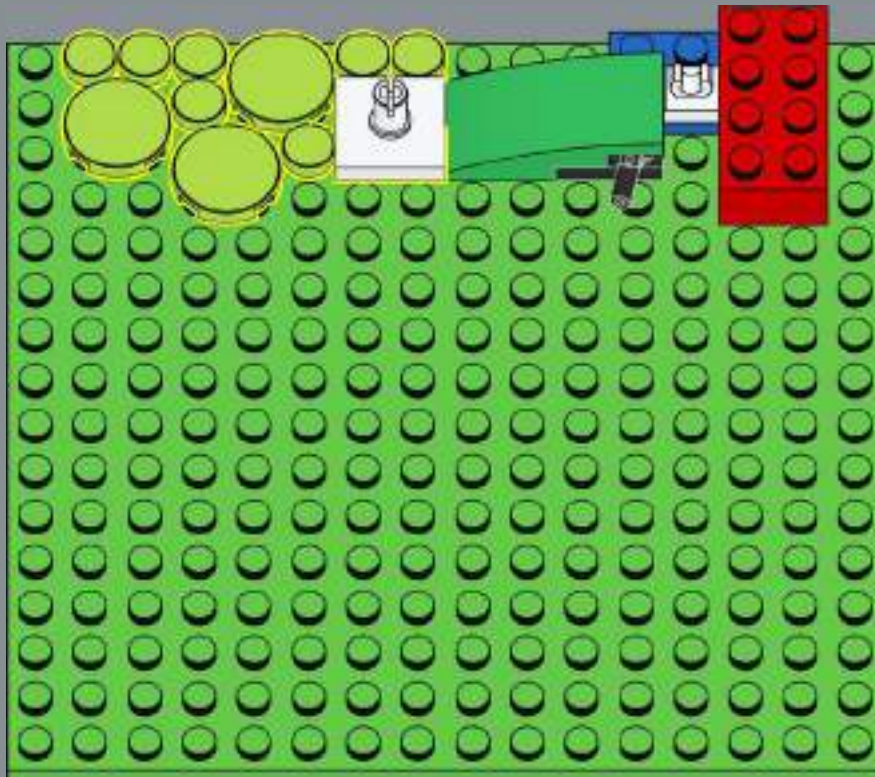

124

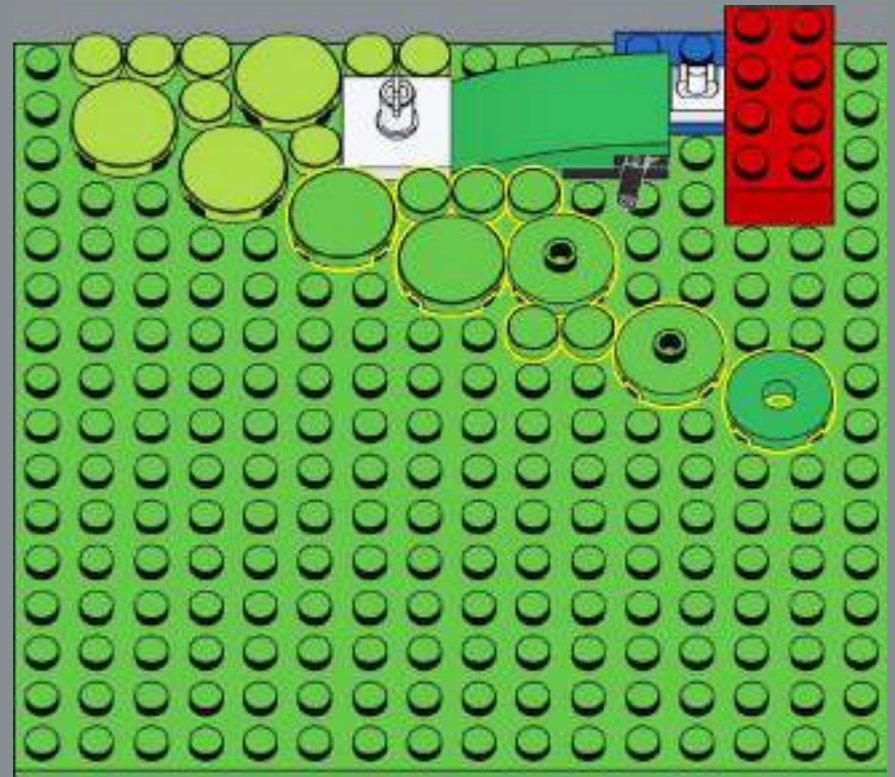



125

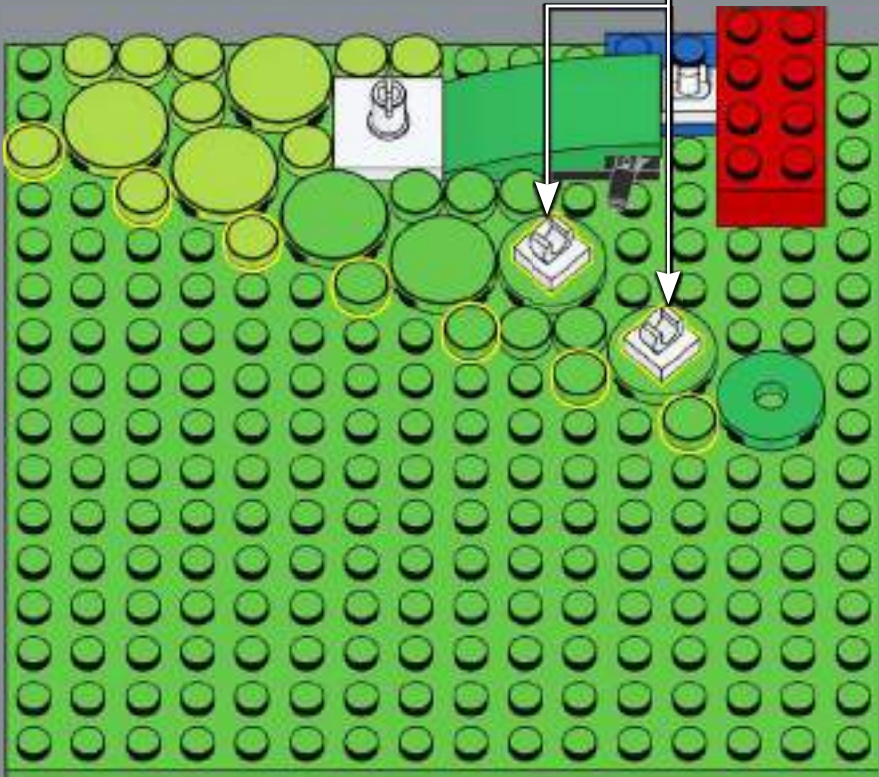
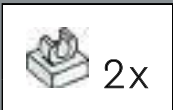

126

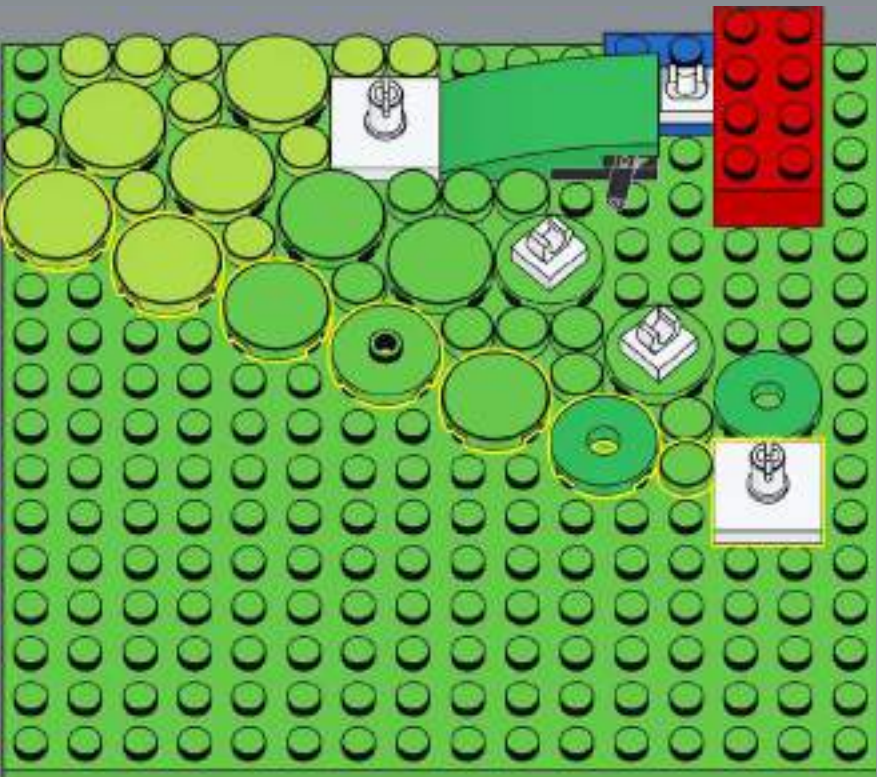



127

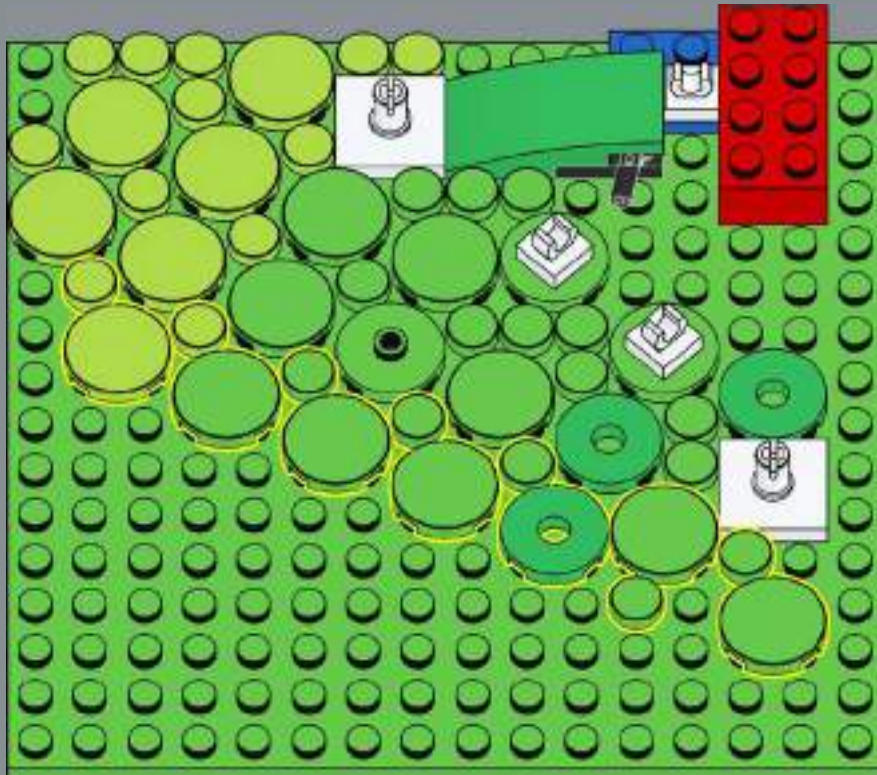

128

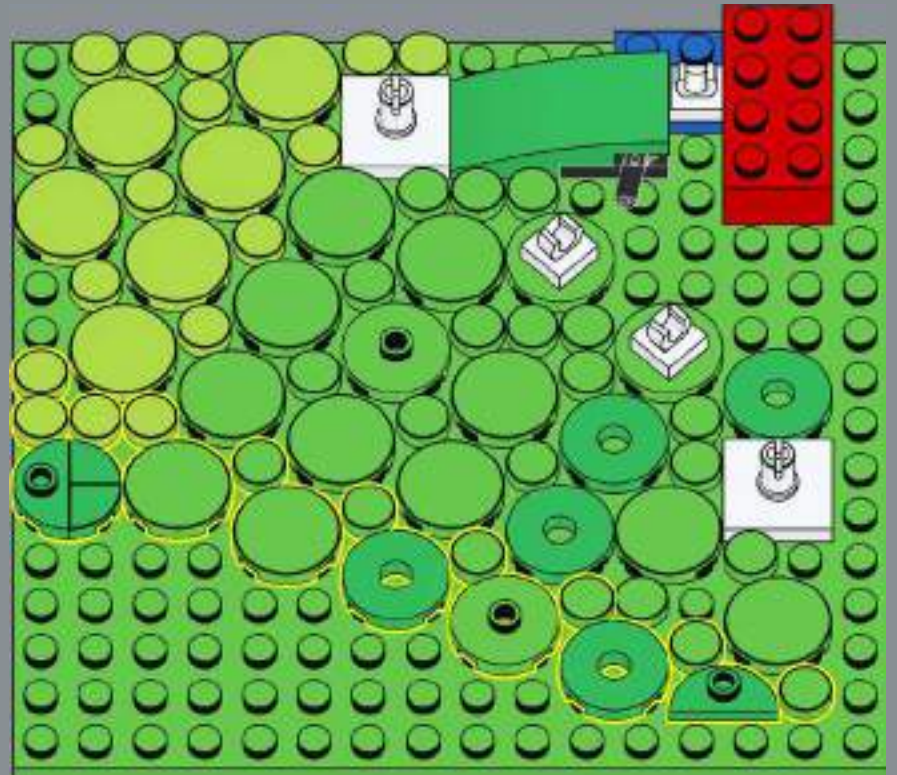

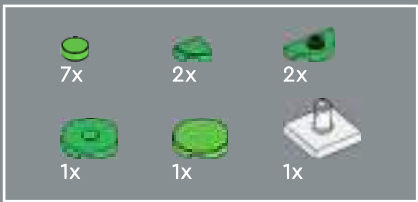

129

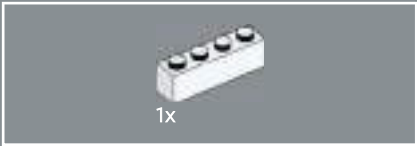
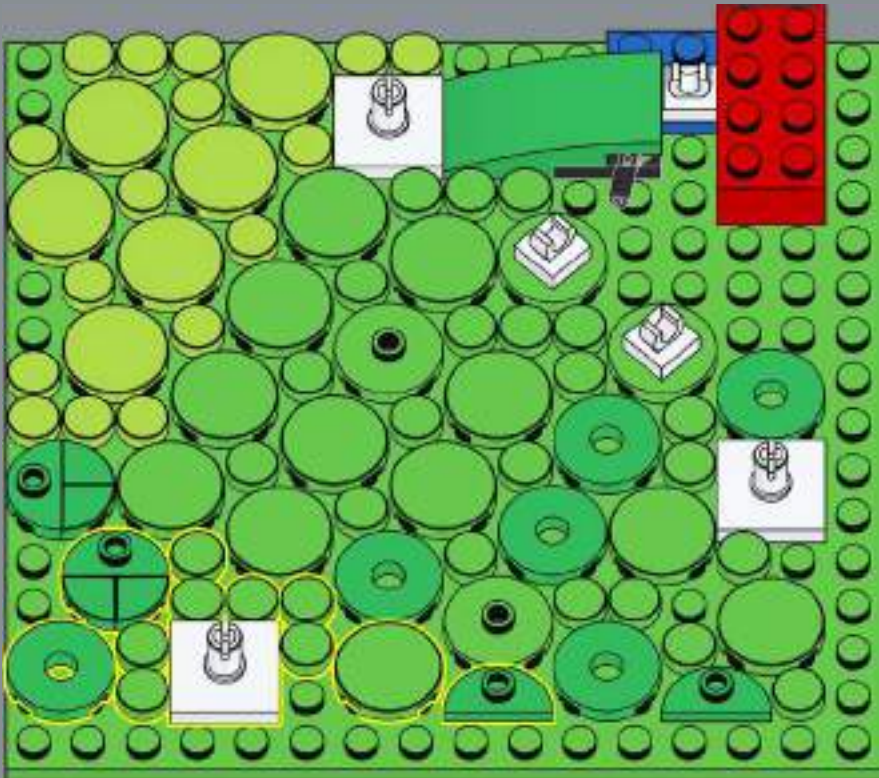

130

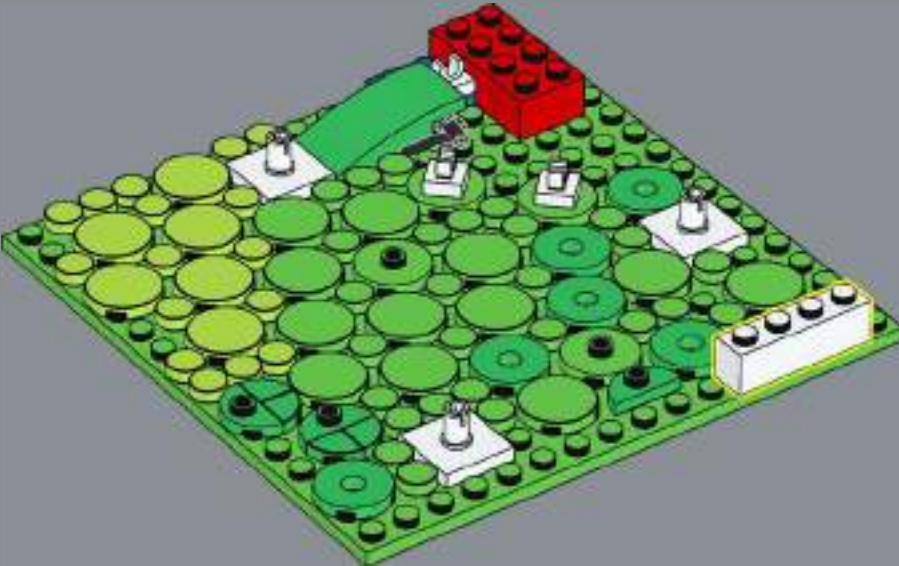

131



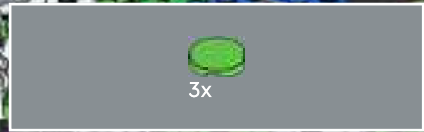

3x

132



3x

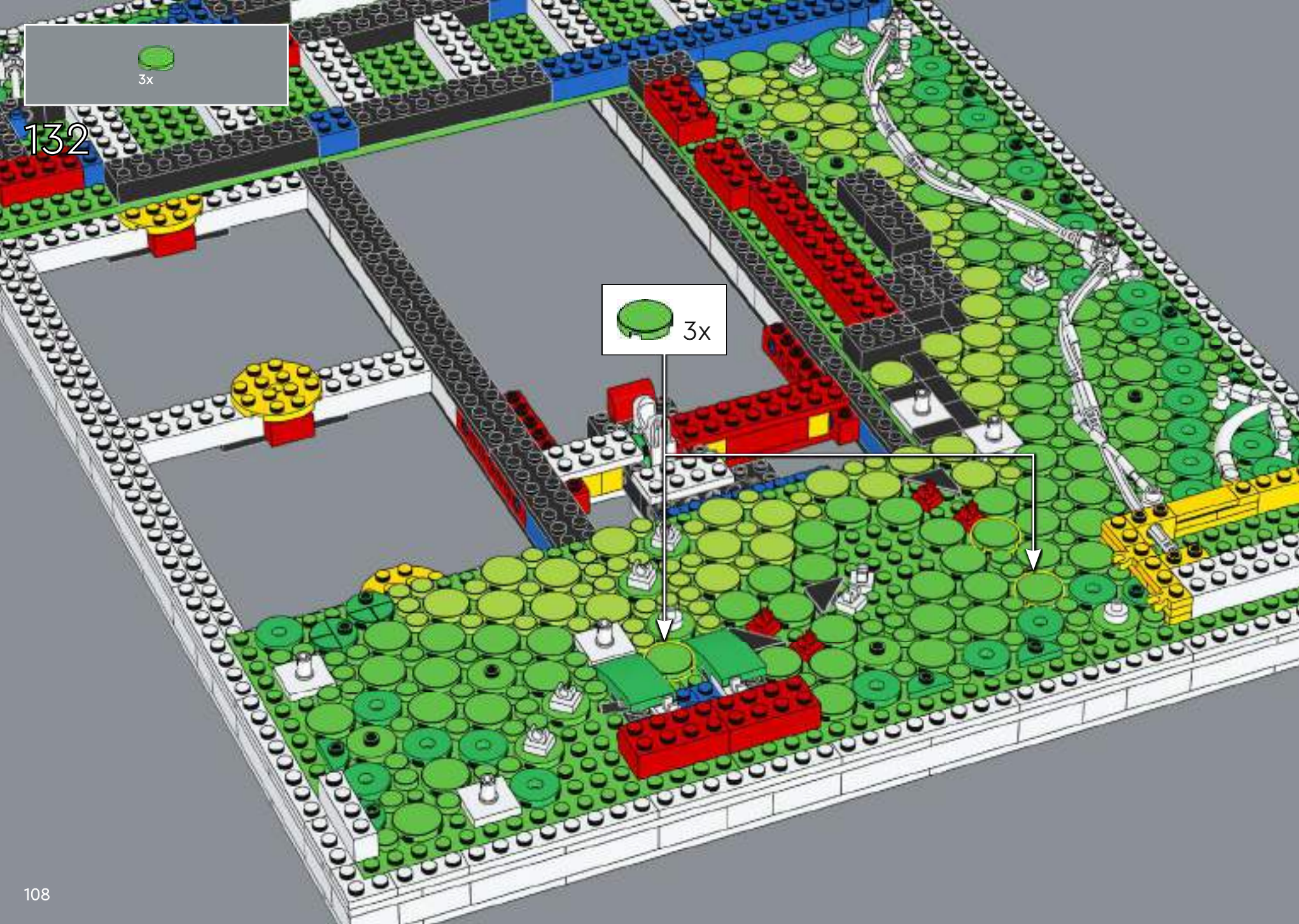



133

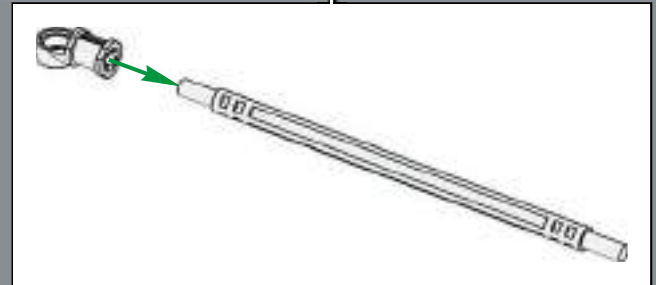
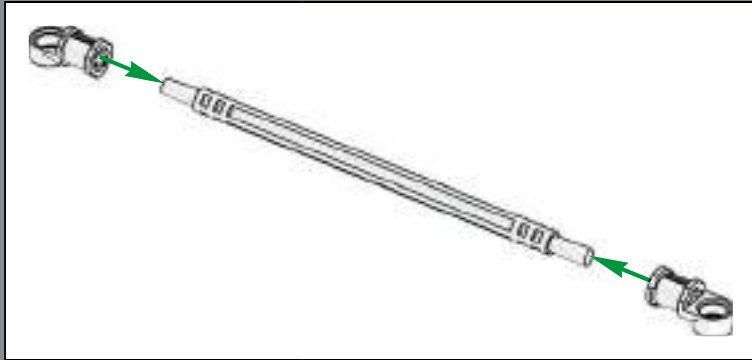
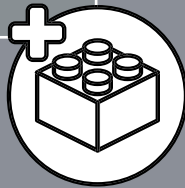

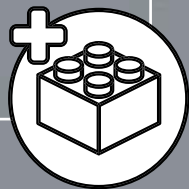
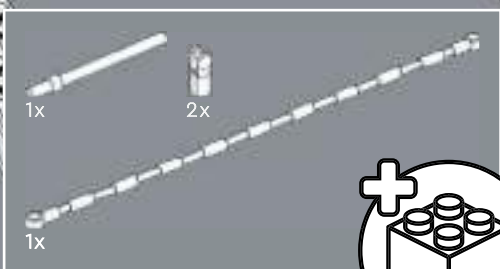

134

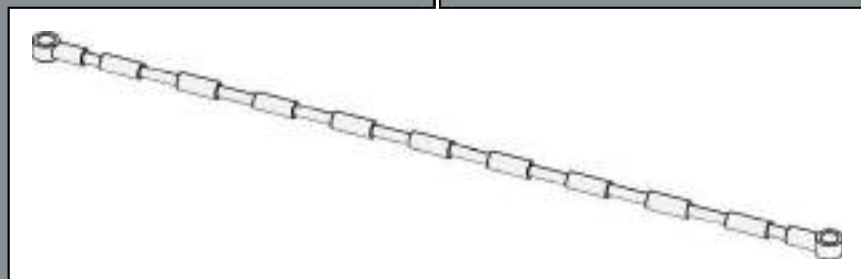
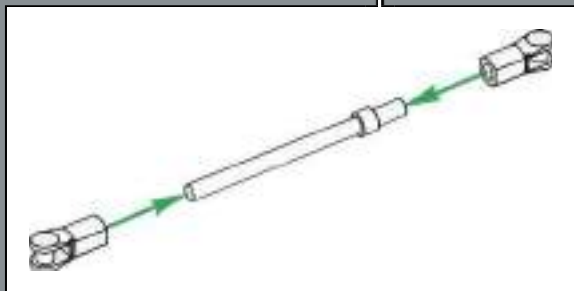

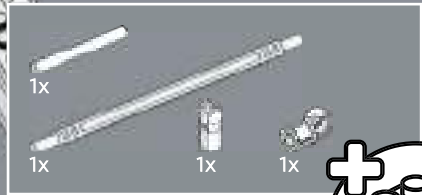

135

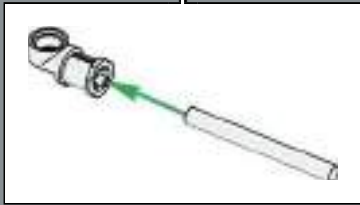
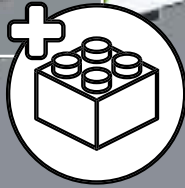

4x
1x

136

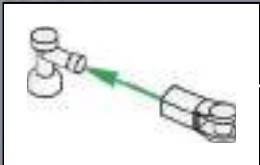

3x

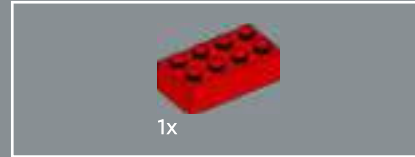
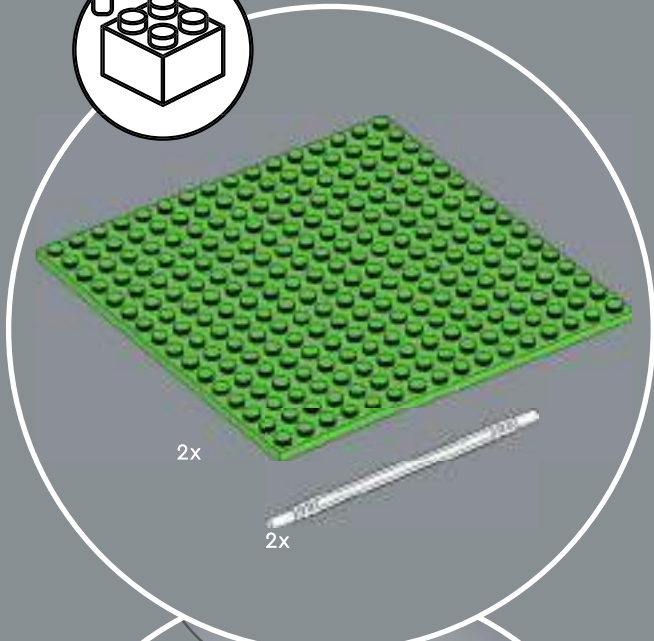
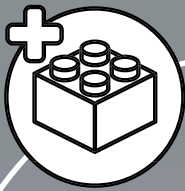

137

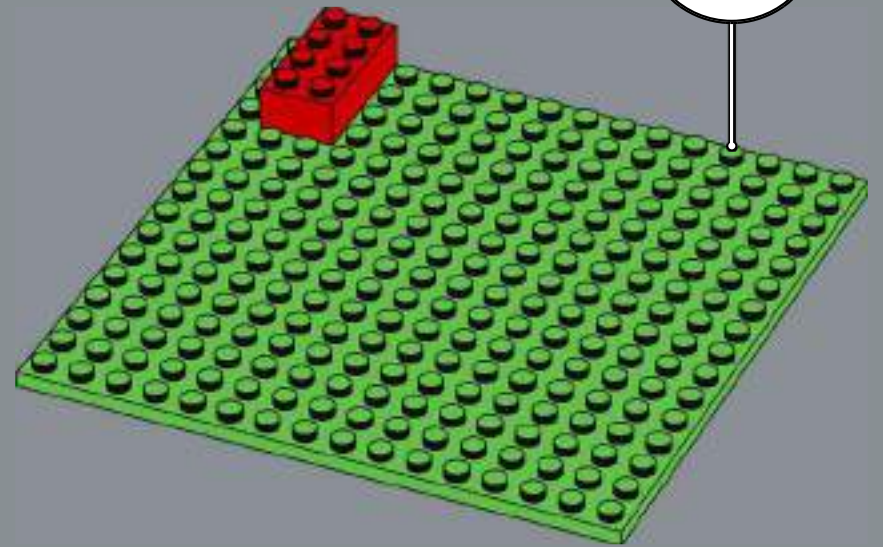
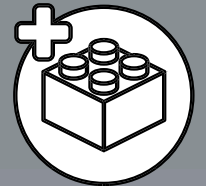



138

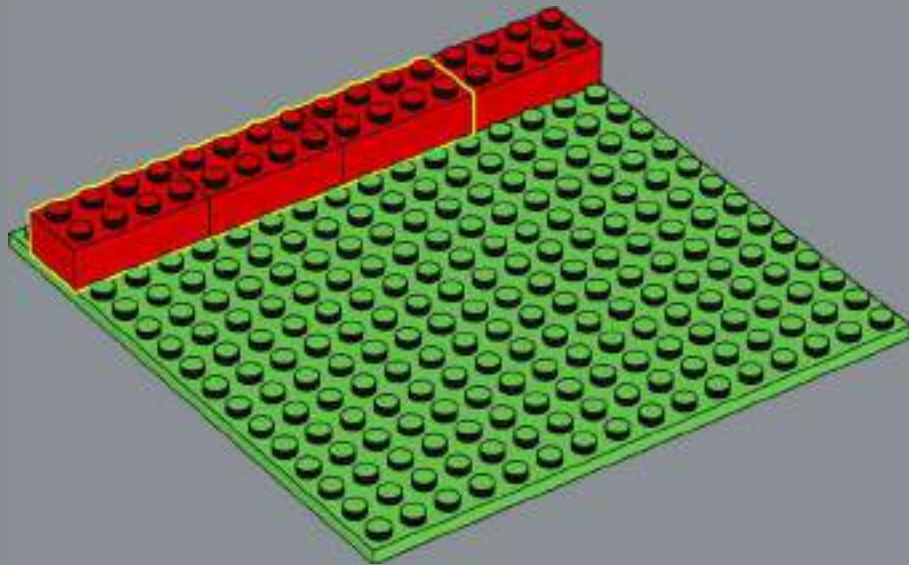

139

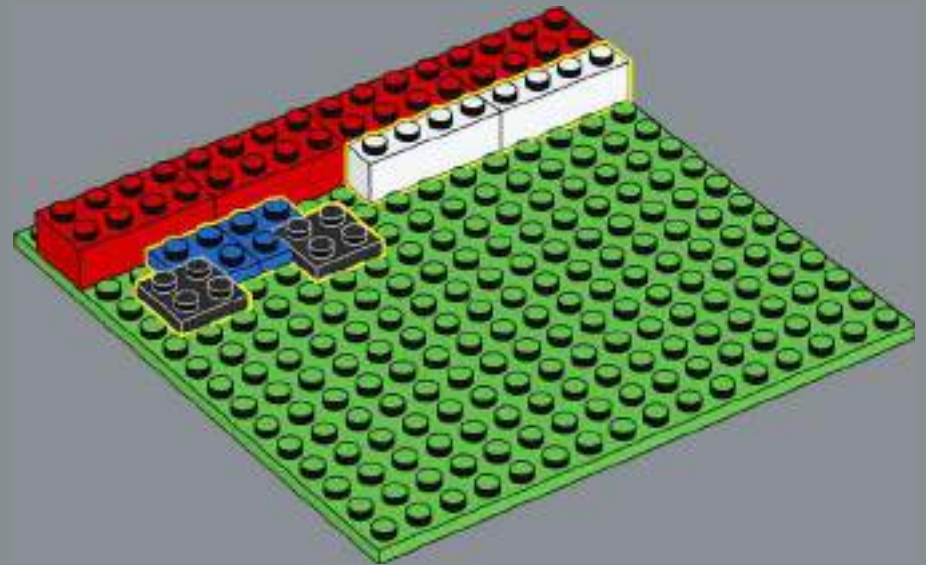



142

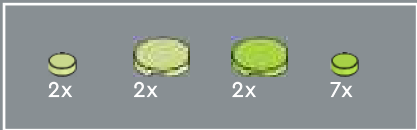
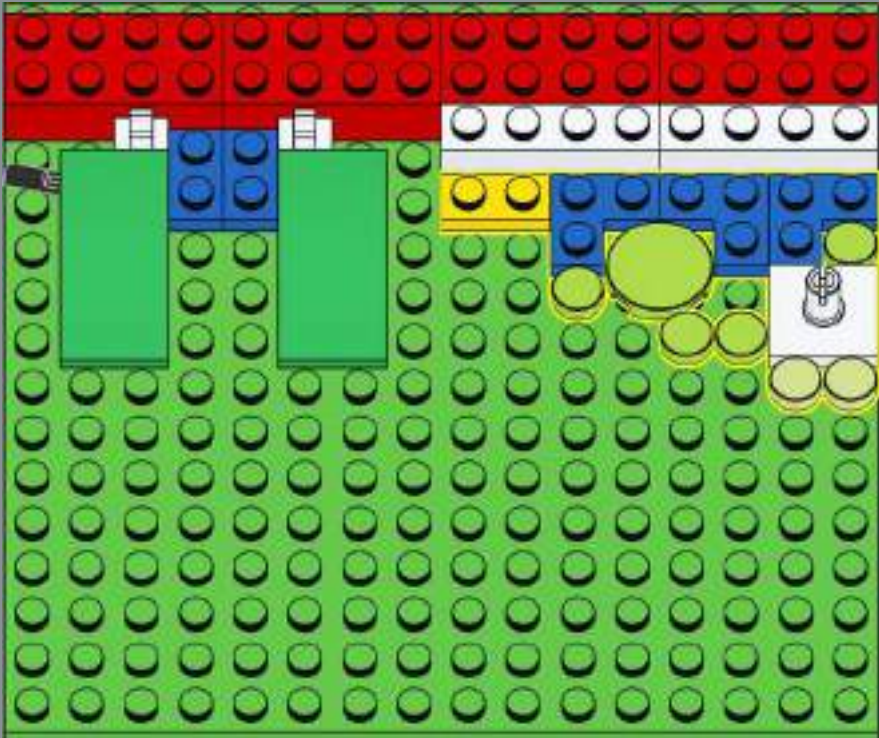

143

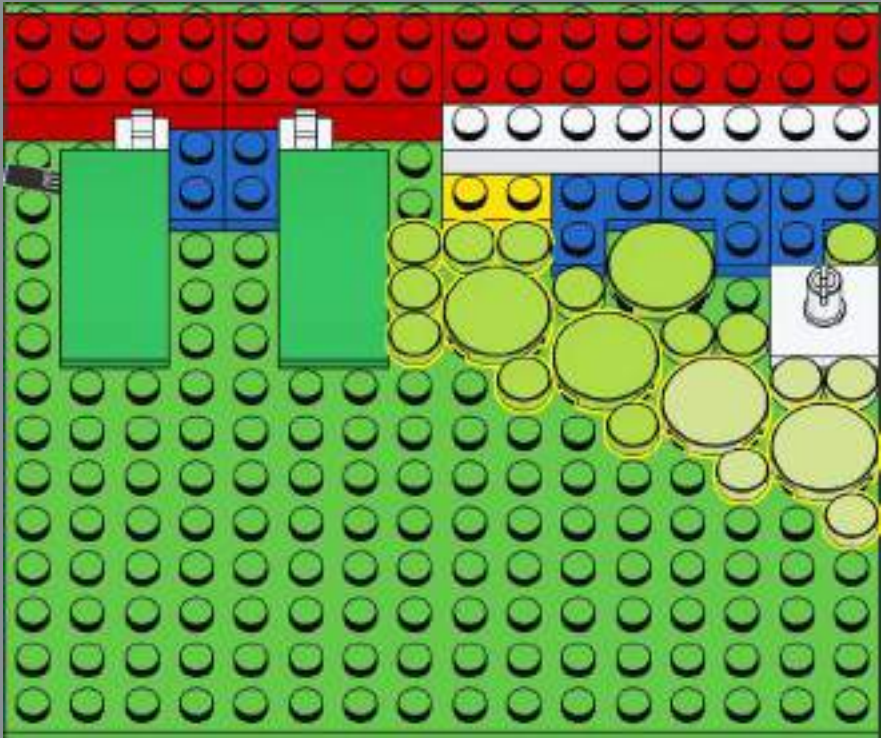

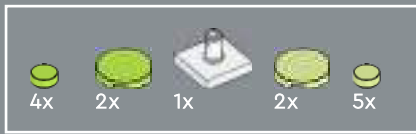

144

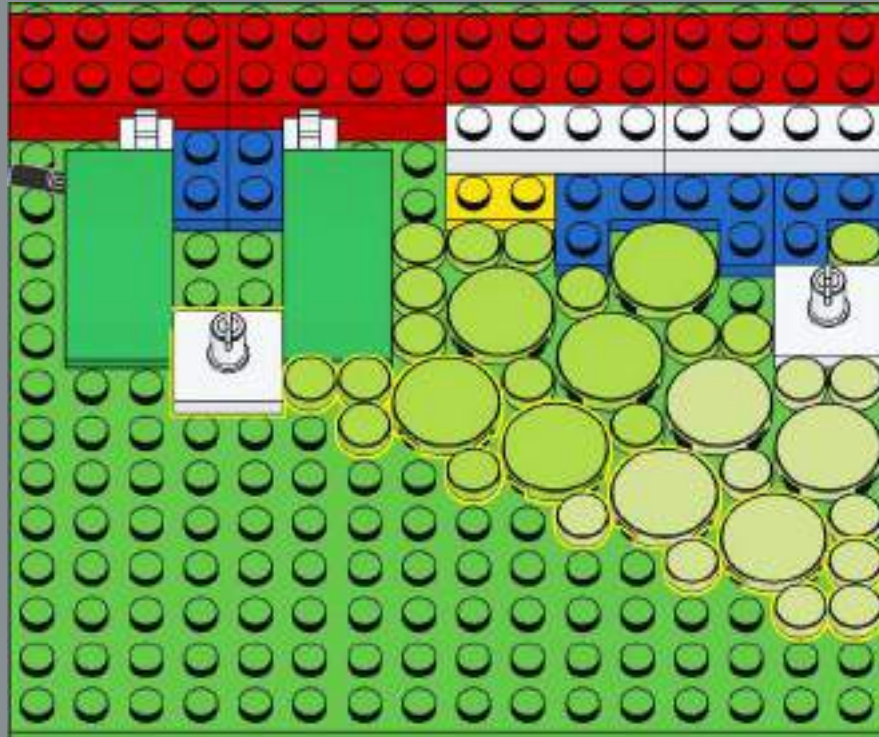

145

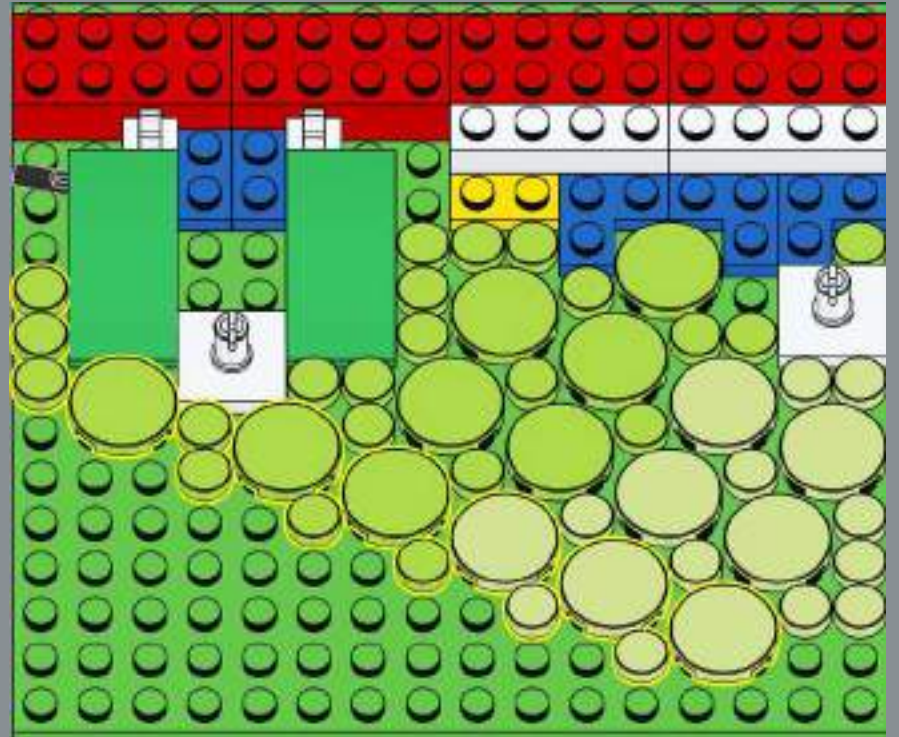



146

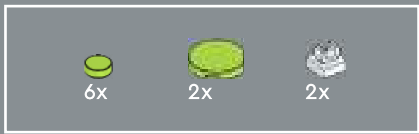
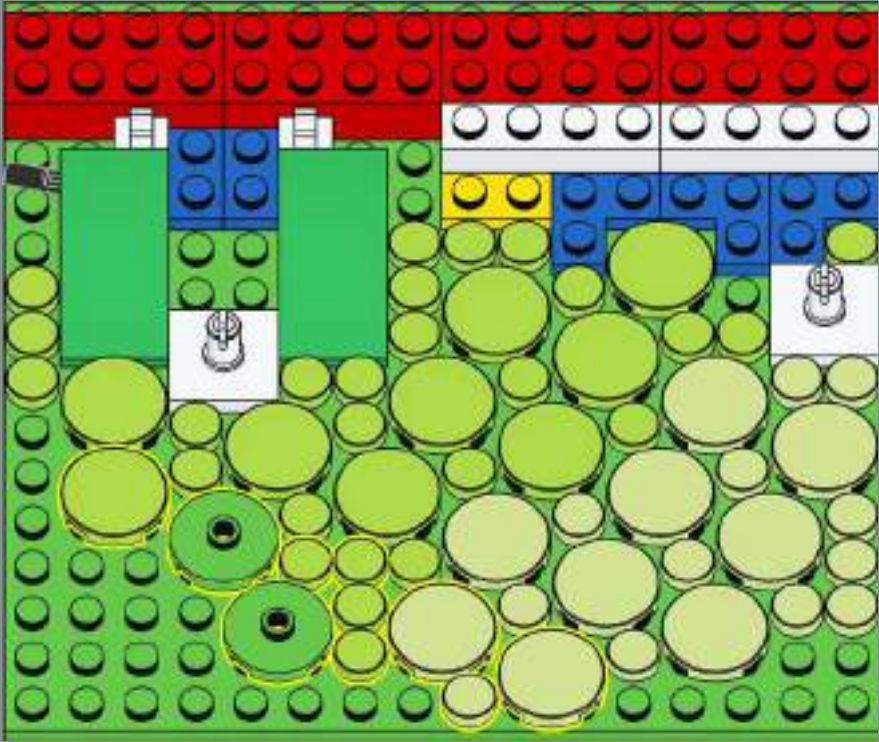

147

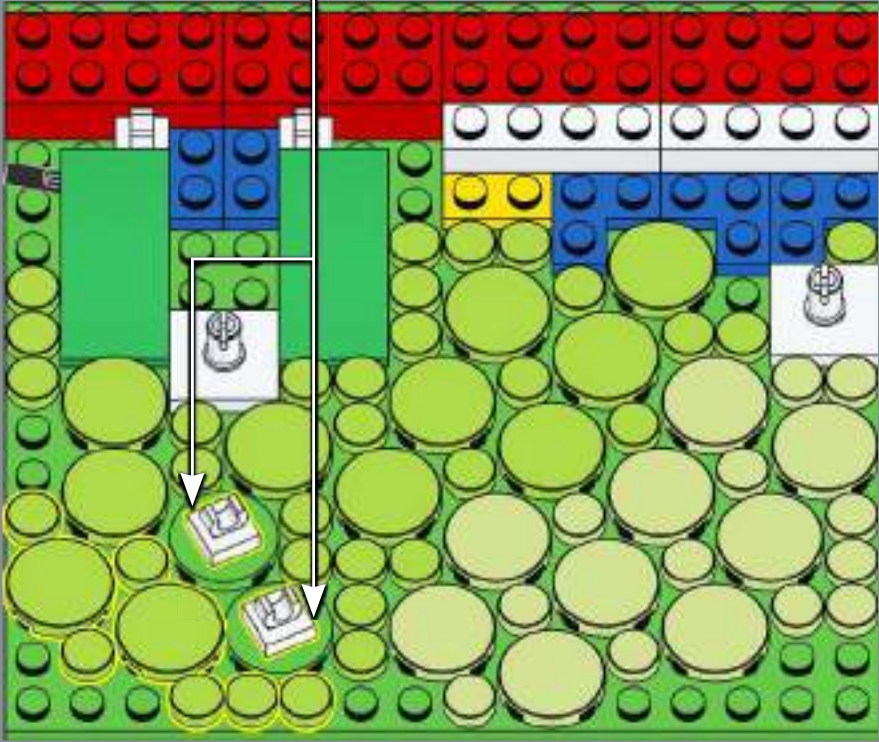





2x

149



2x



120



1x

150

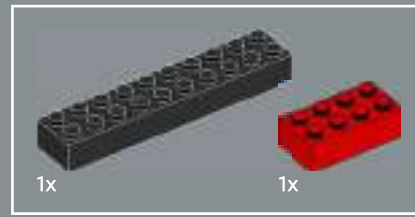
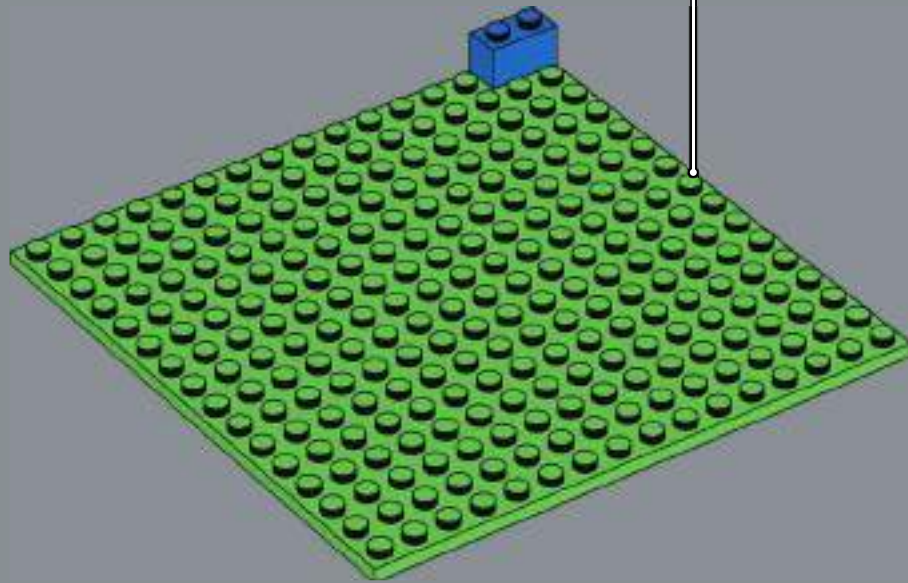
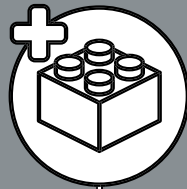

1x

1x

151

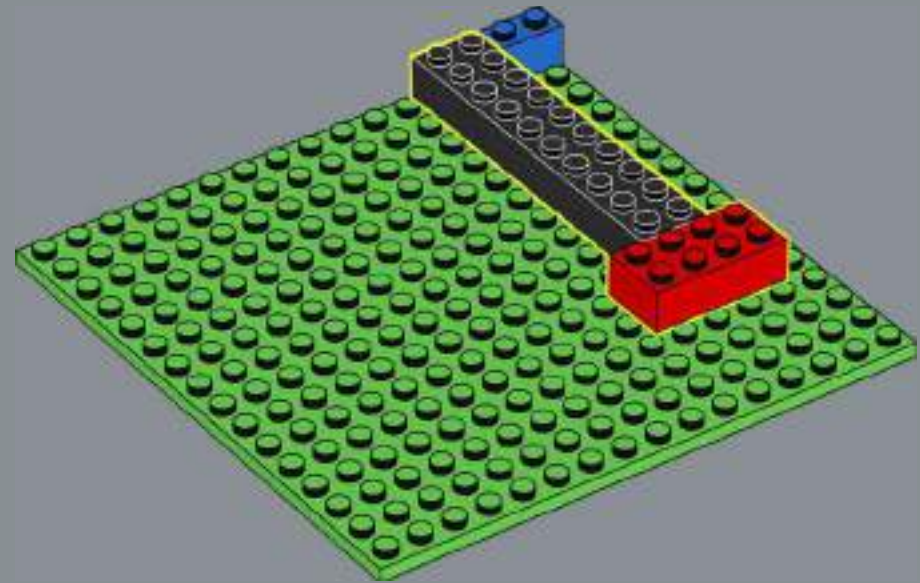



152

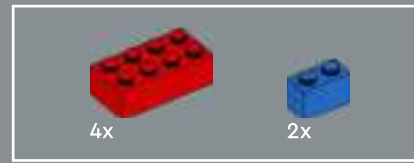
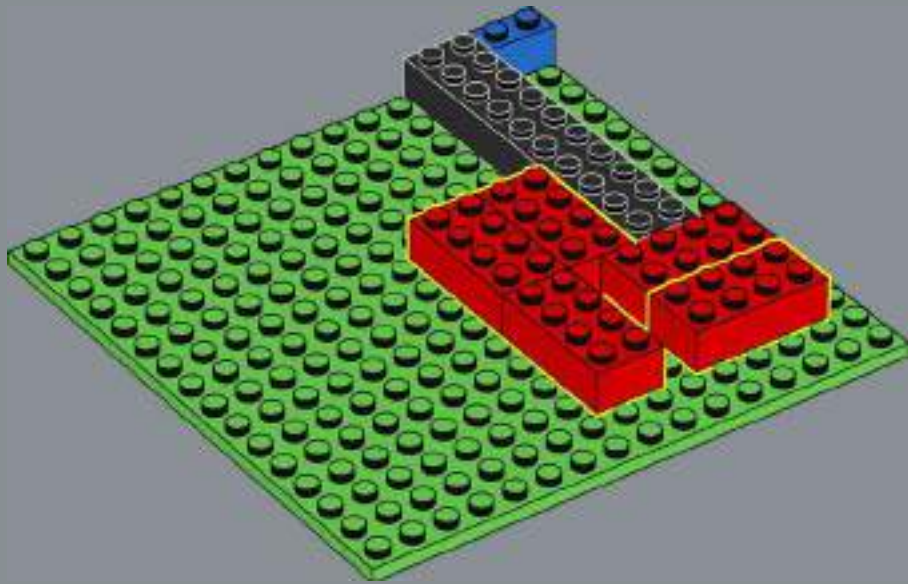

153

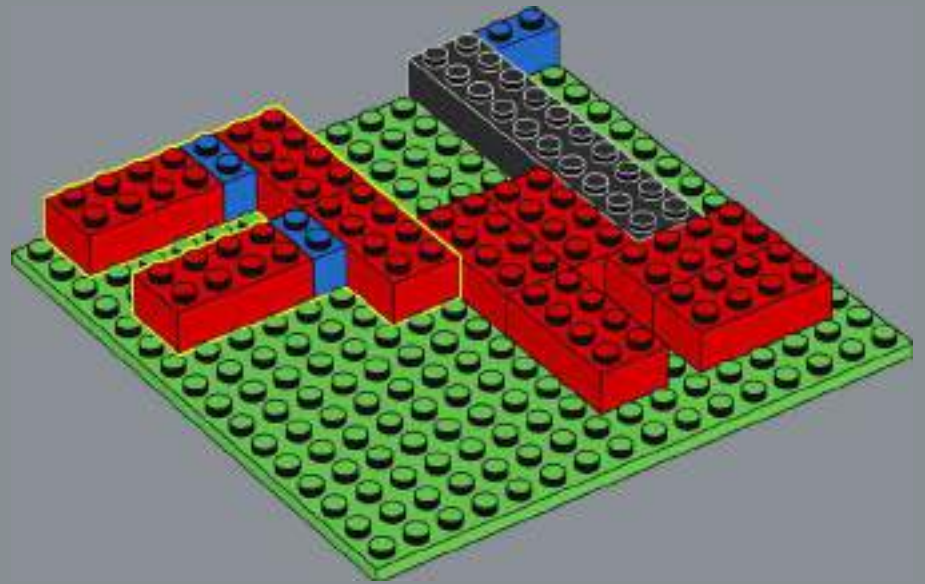

Did you know that the 10294 LEGO® Titanic contains a record amount (40) of iconic red 2x4 bricks? So far, you have placed 35 ...



154

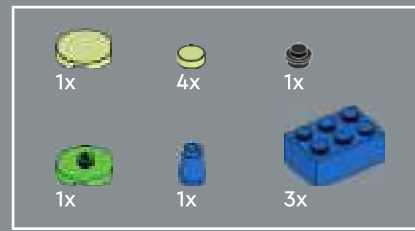
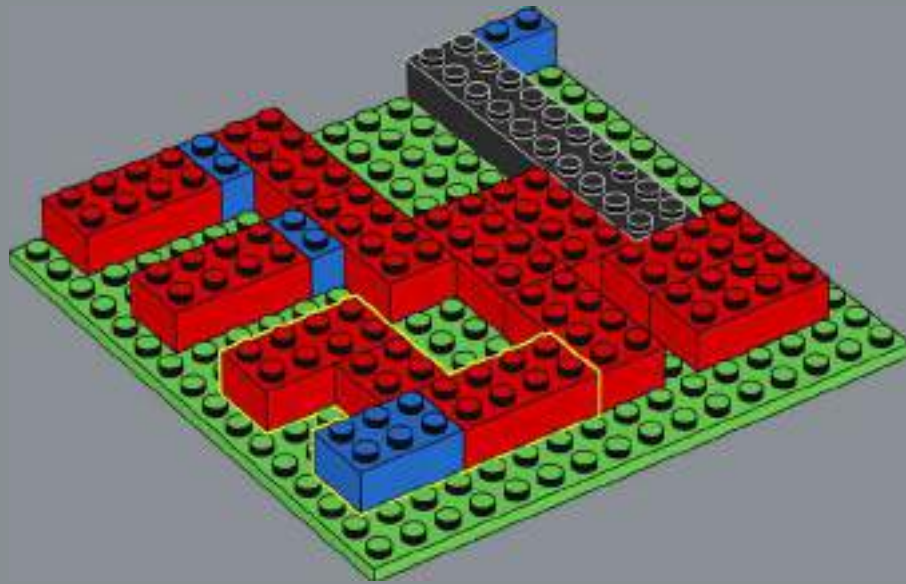

155

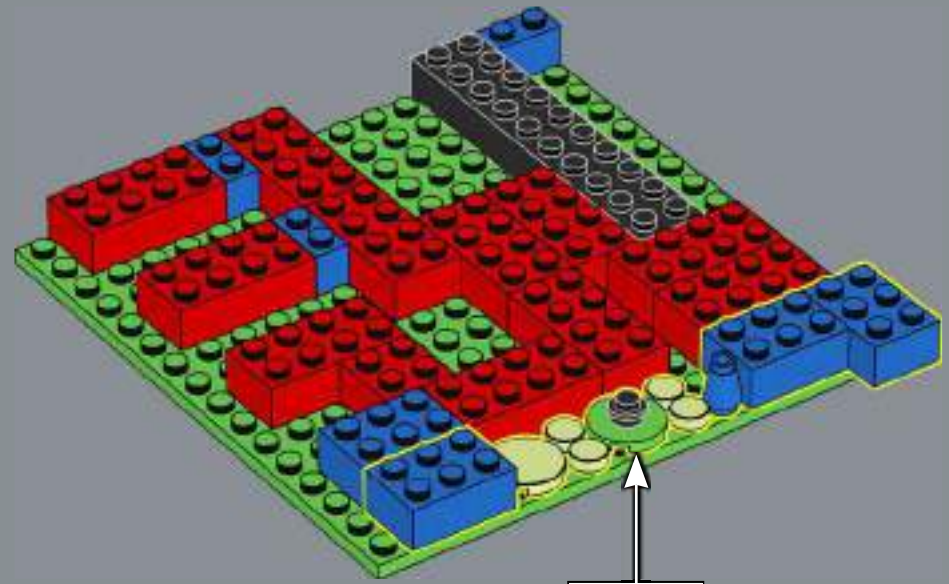

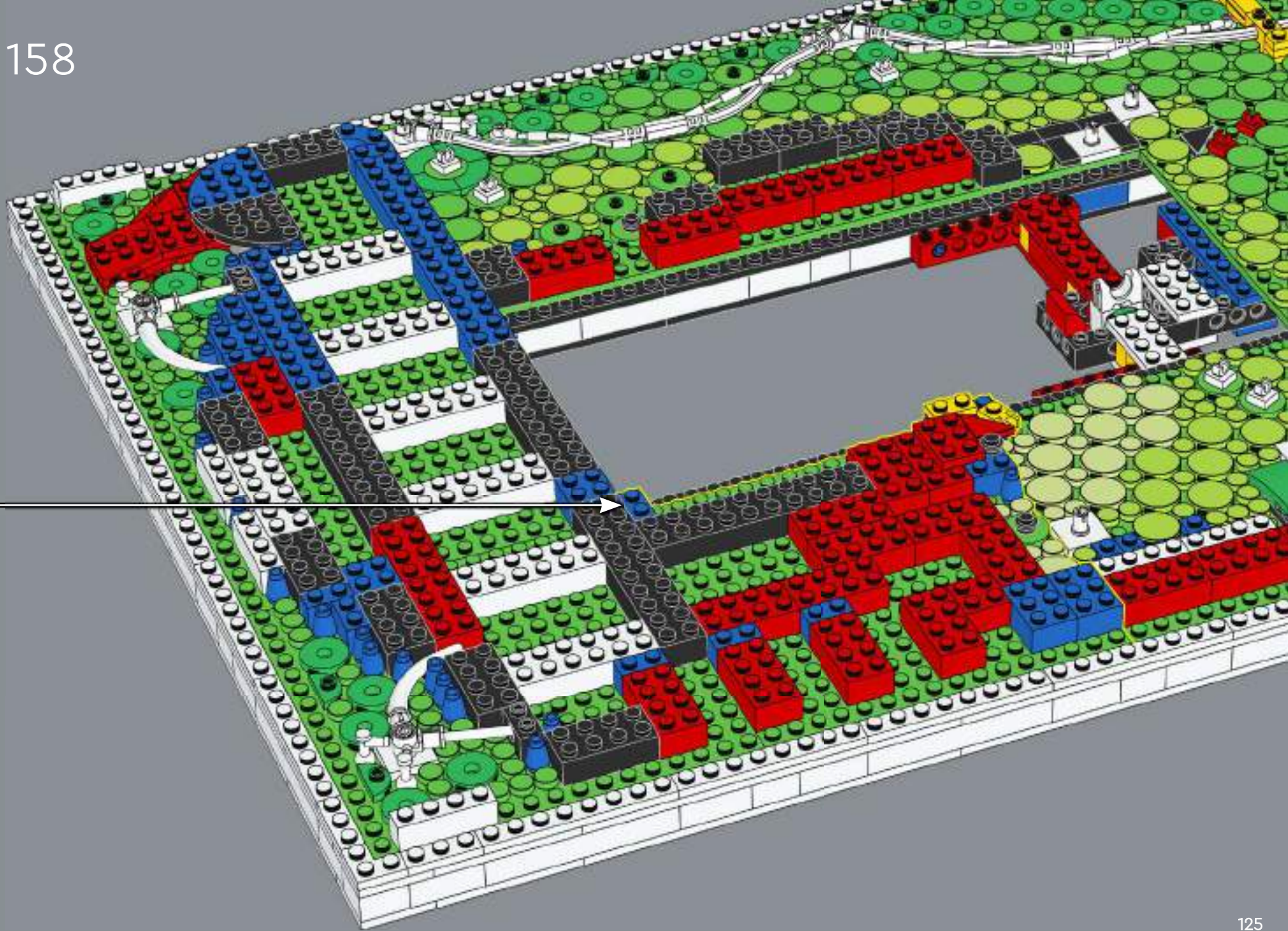

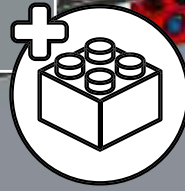

159

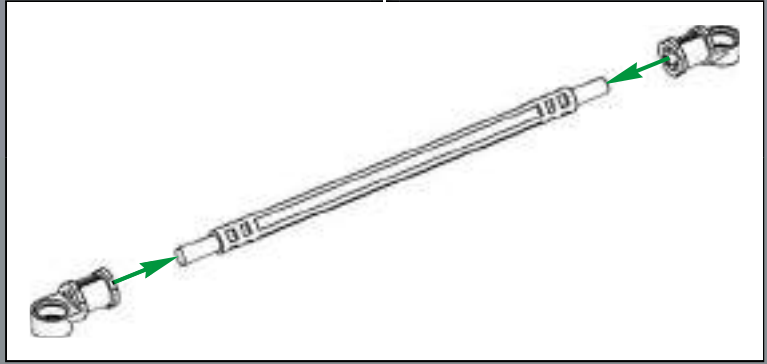
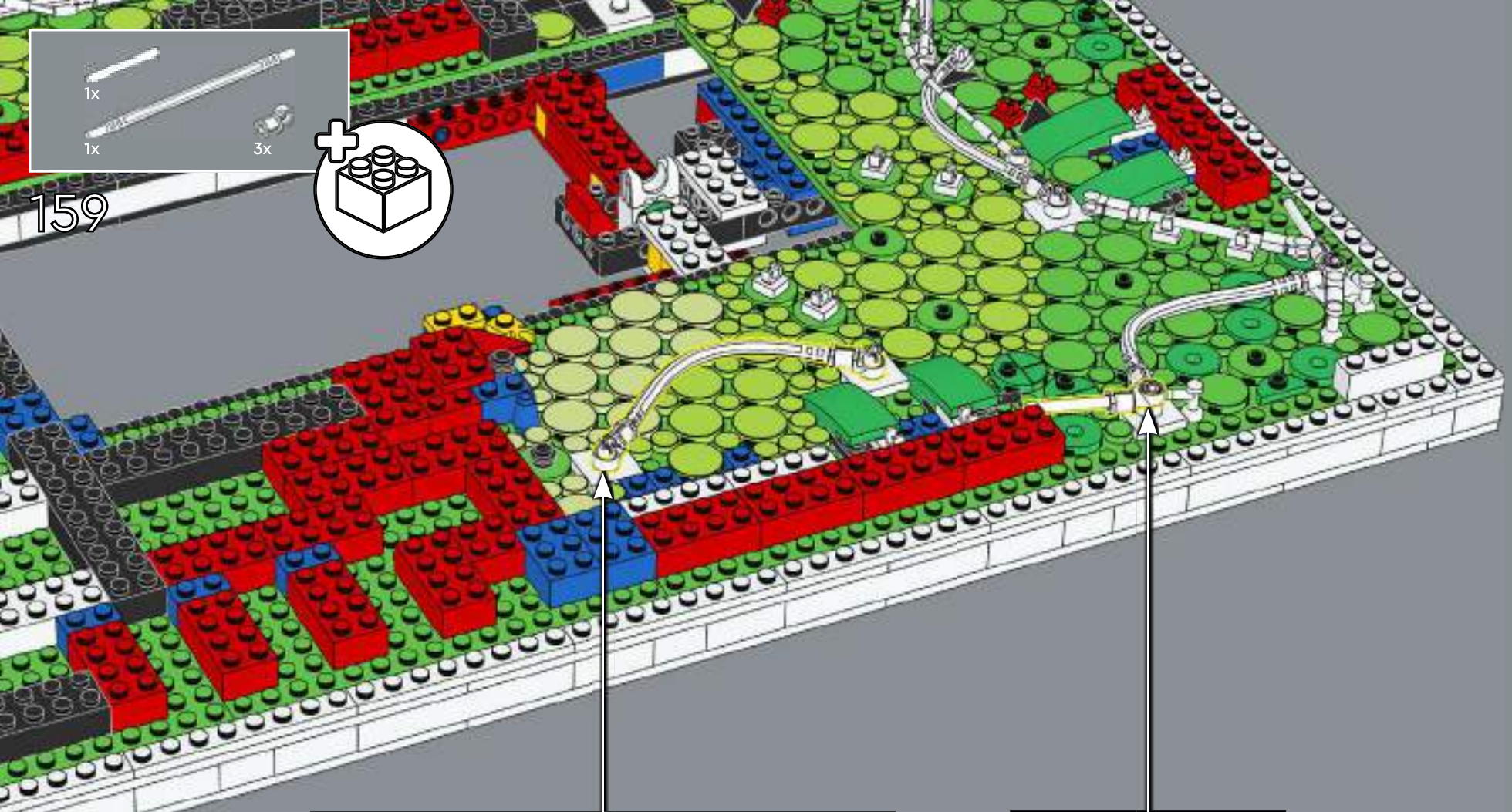

- 3x 
- 1x 
- 1x 



160

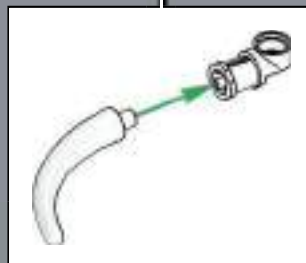
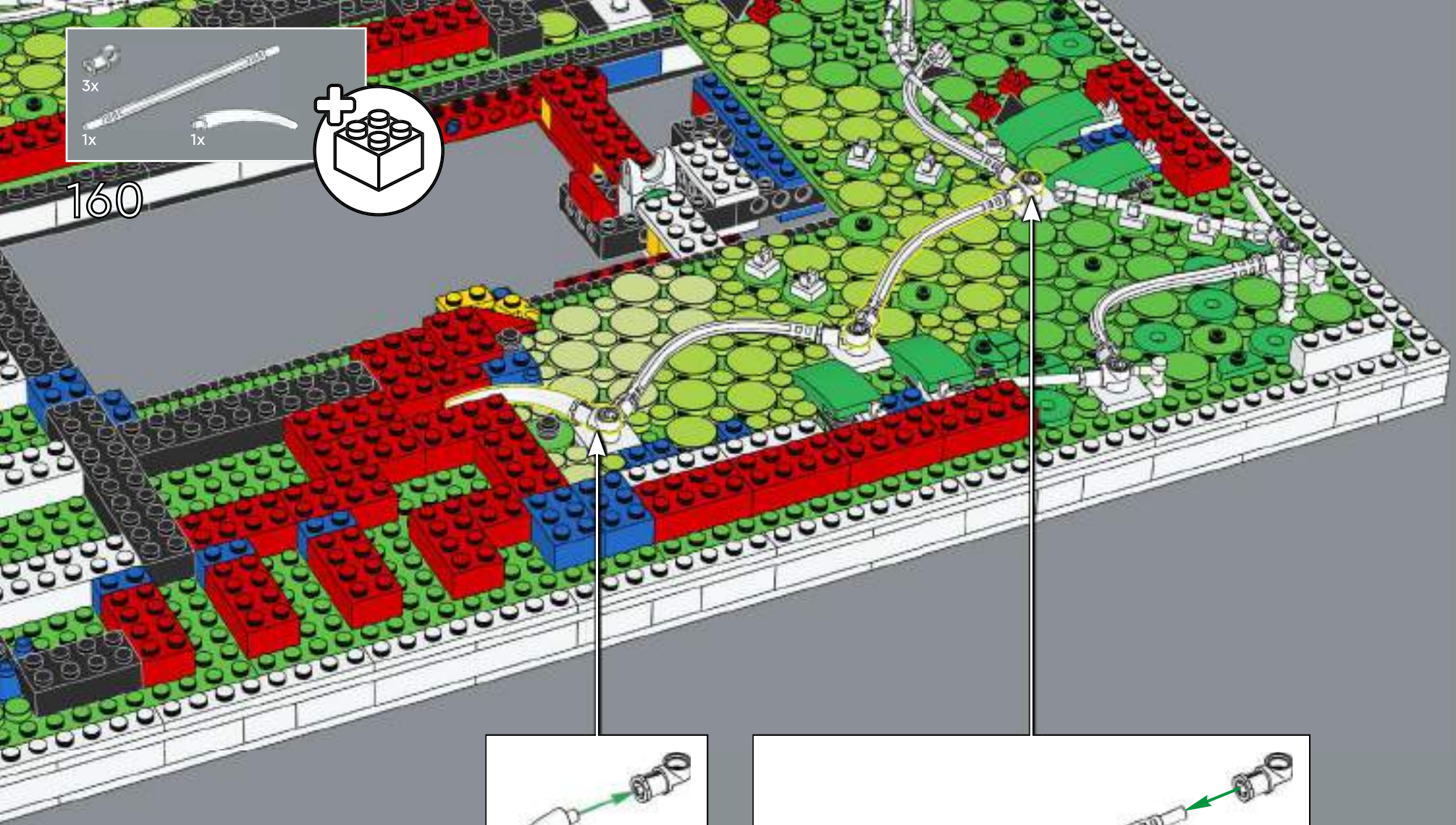

1x  2x 

161

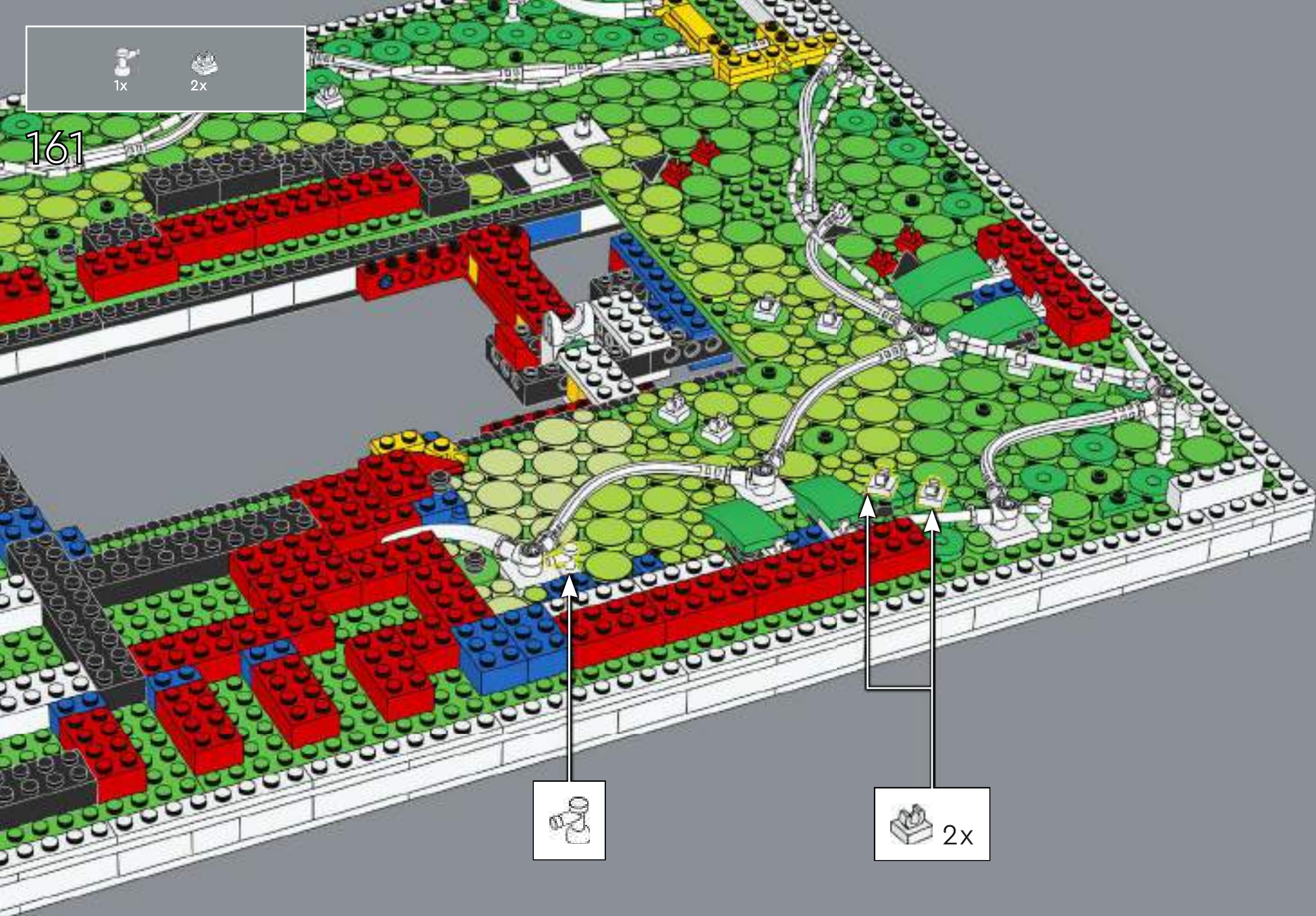



 2x



162



The tensile strength of Spider-Man's web lines has been estimated at around 120 pounds per square millimetre of the cross-section.

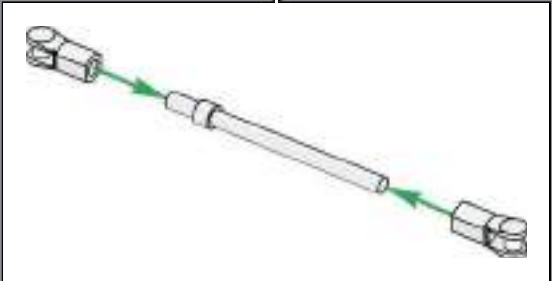

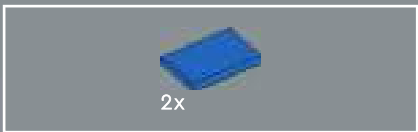

163





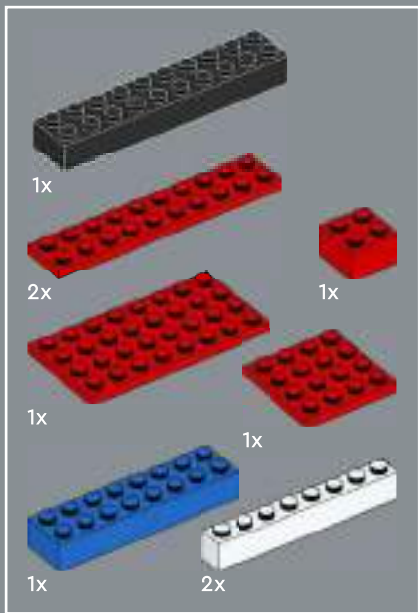

164

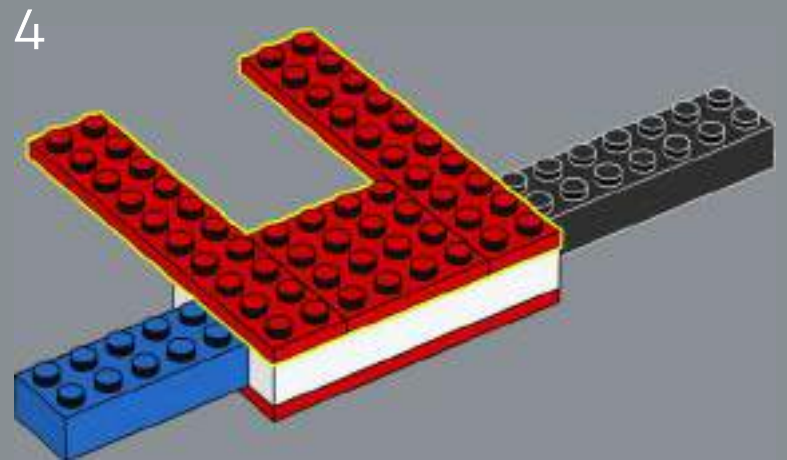
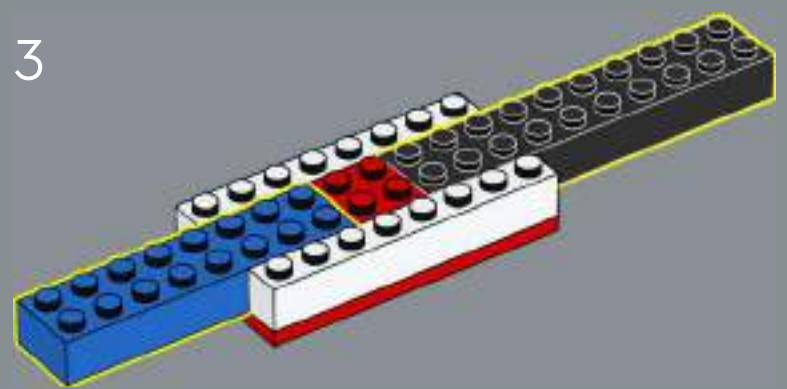
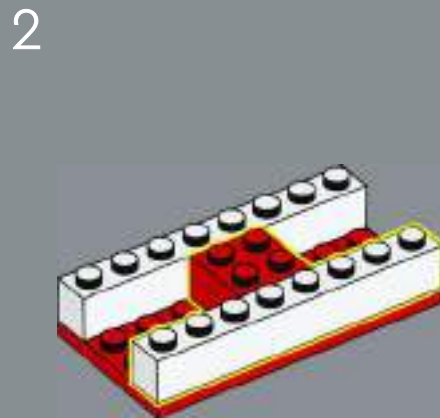
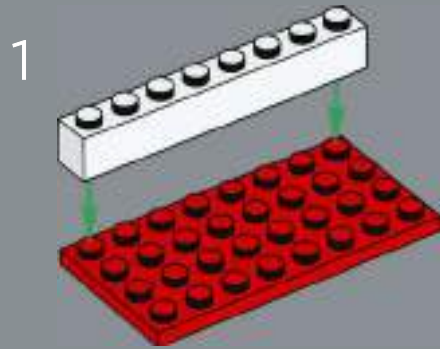



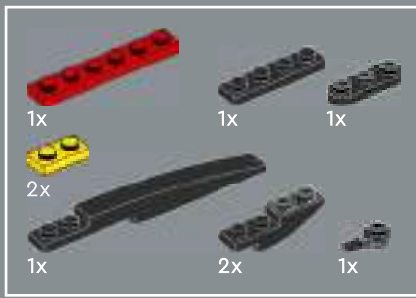

166

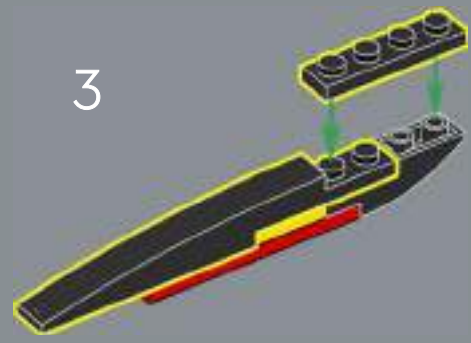
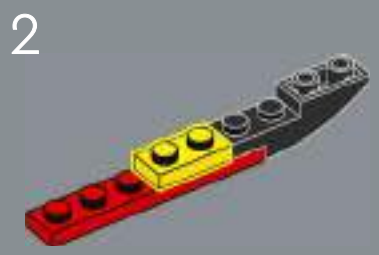
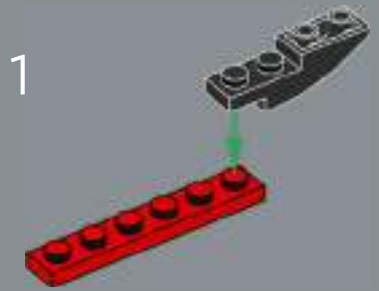

When blue becomes yellow, suddenly this section evokes the costume of Jessica Drew aka Spider-Woman, who first appeared in Marvel Spotlight #32 from 1977!





167



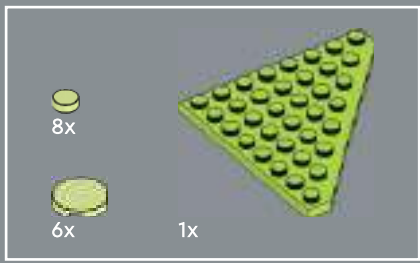

168

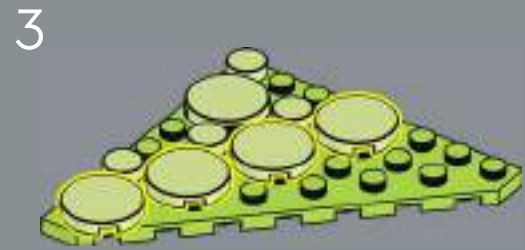
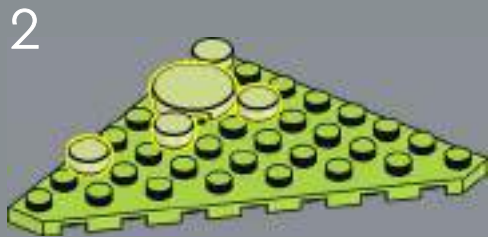
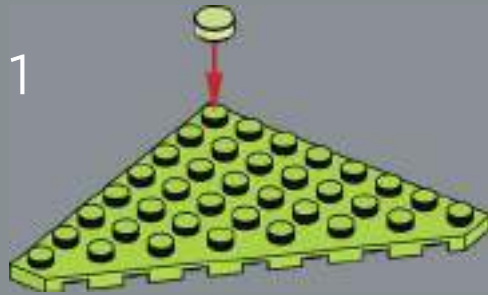



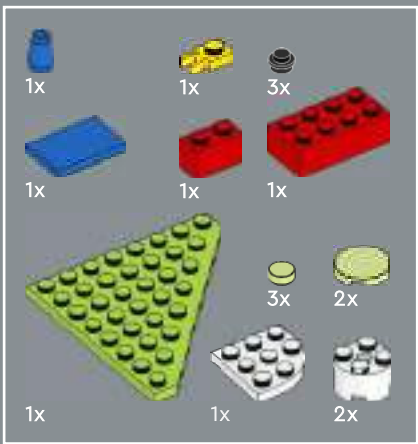

169

1

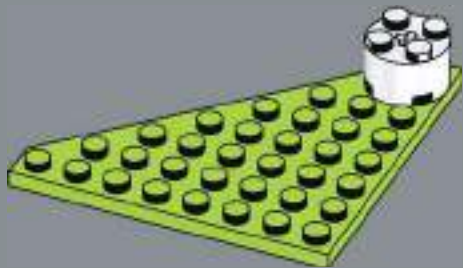

2



3



4



5







4x

170



4x

142





171



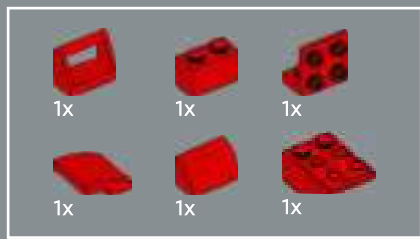

172

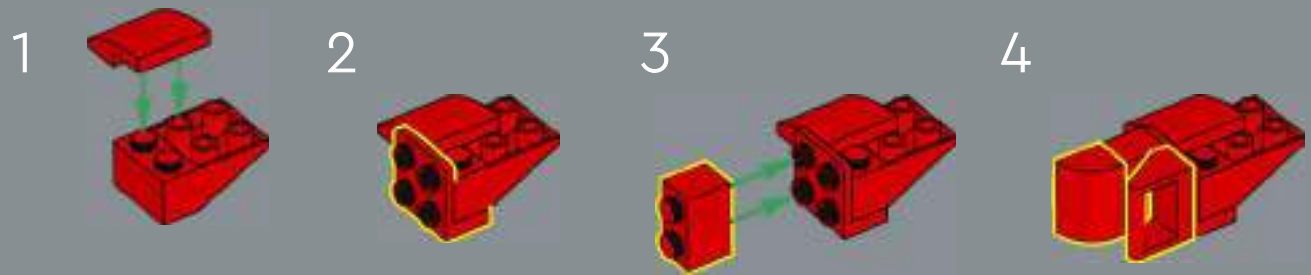



173



- 2x 
- 3x 

174

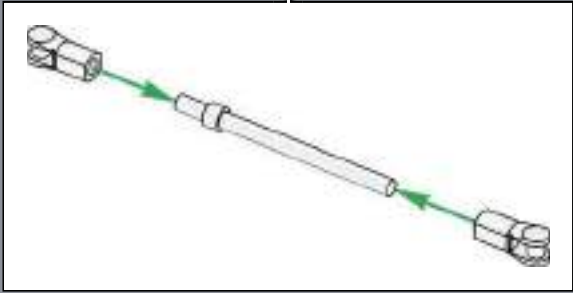
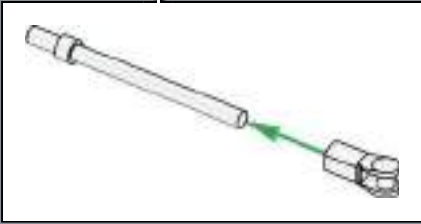
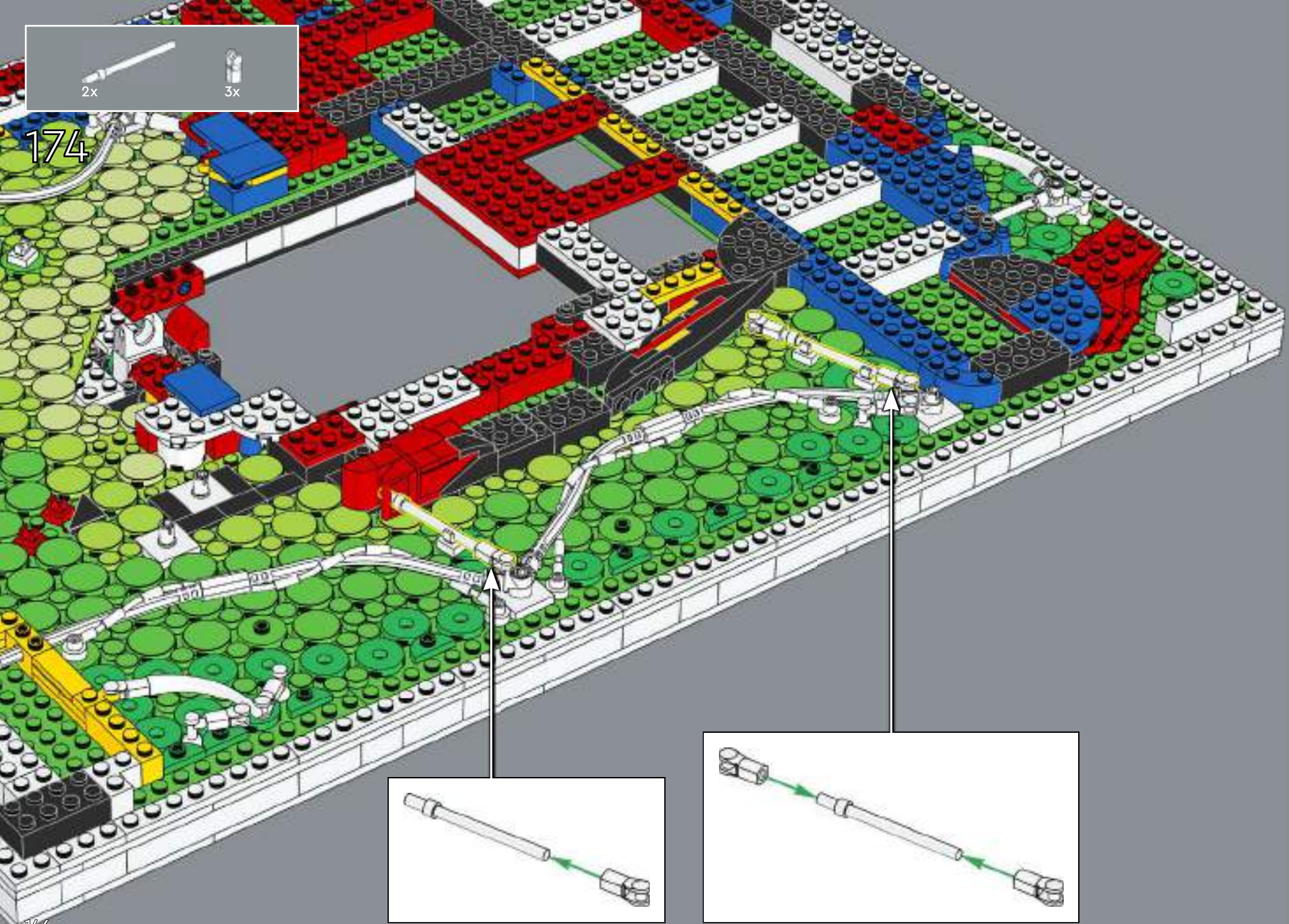

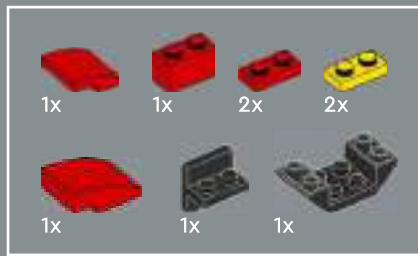

175



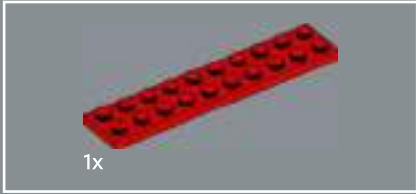

176

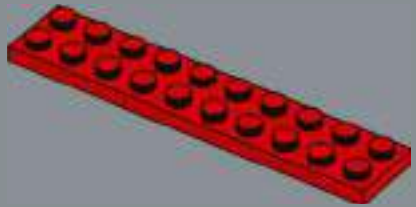

177

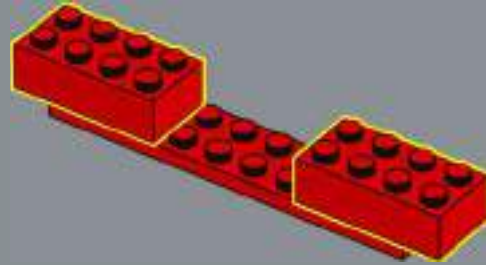

178

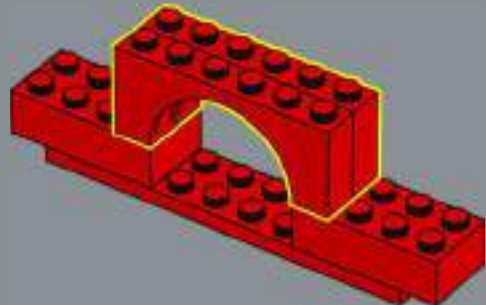

179

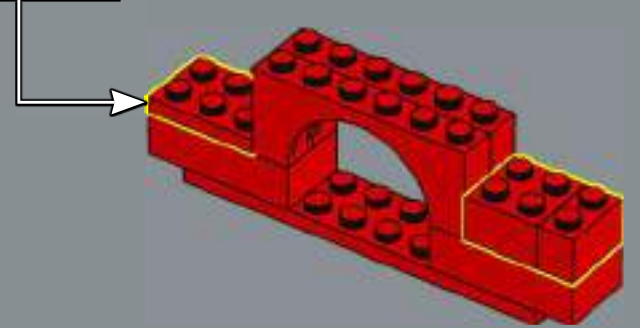

180

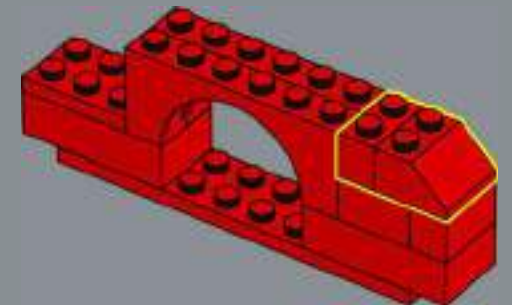

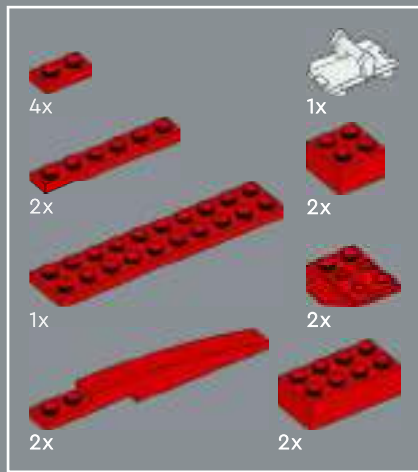

181

1

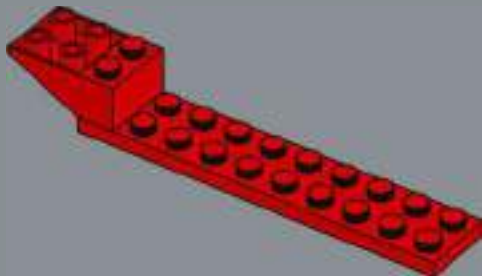

This is the 42nd red 2x4 brick you have placed in this model!

2

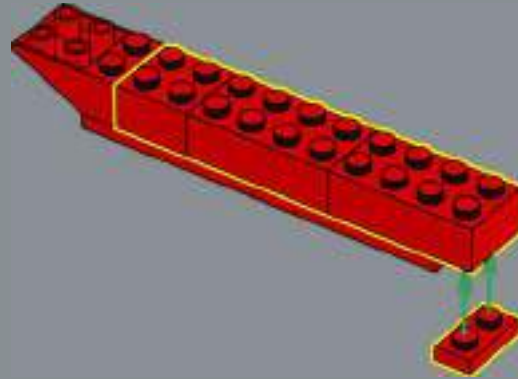

3

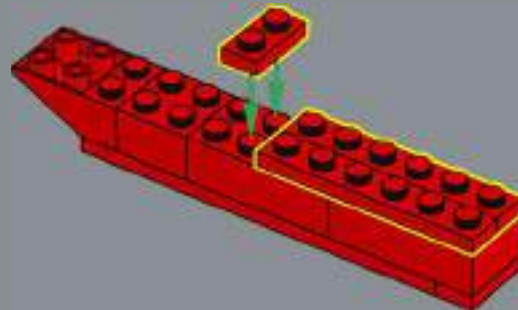

4

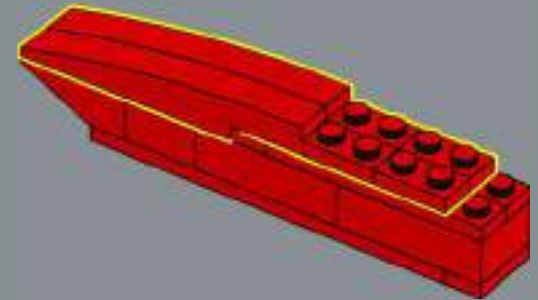

5

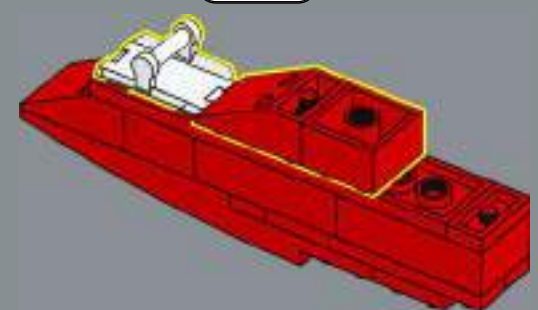

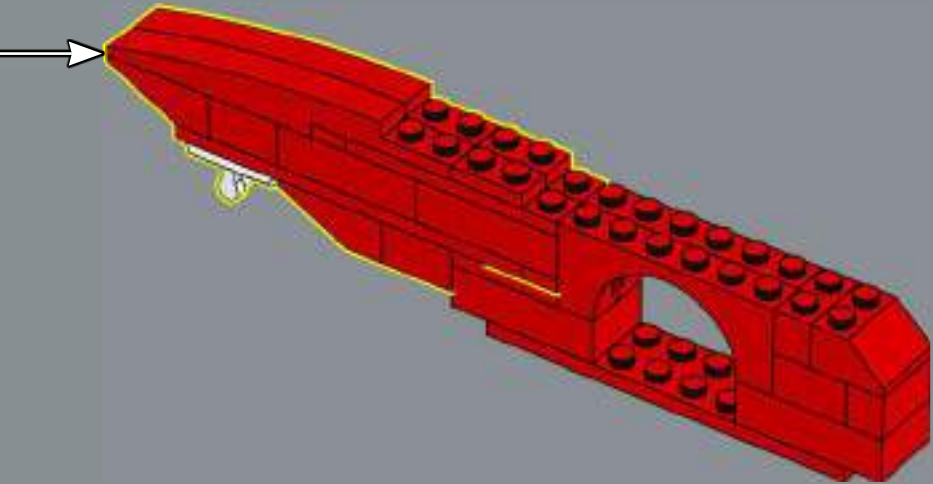

182

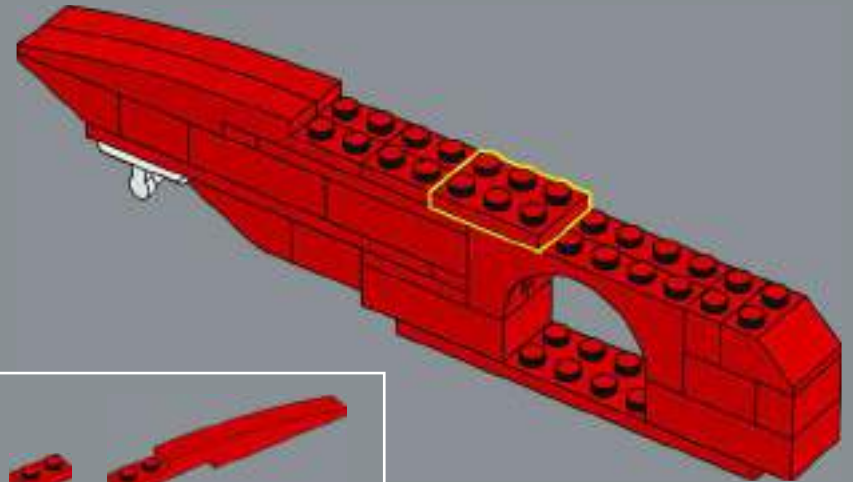

183

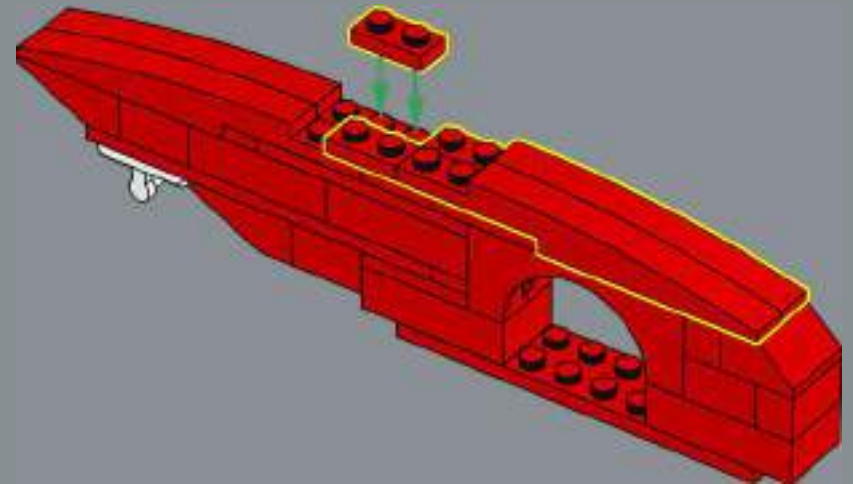

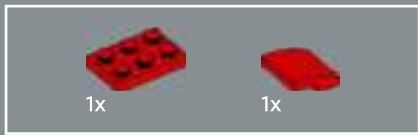

184

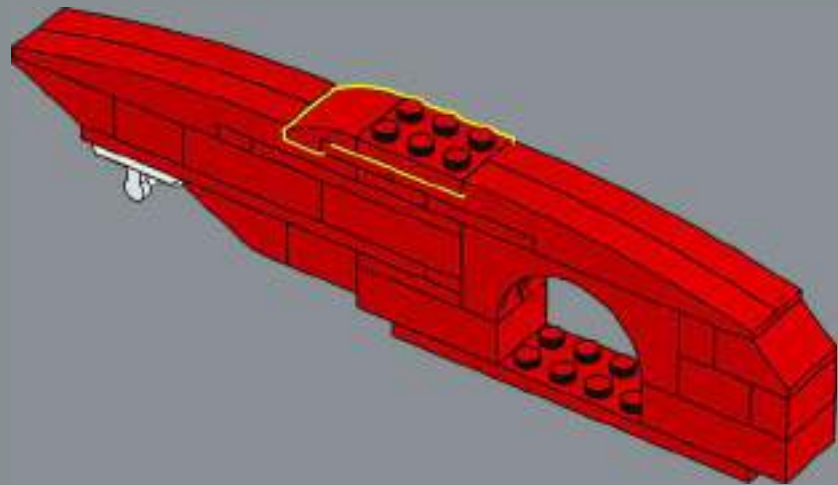

185

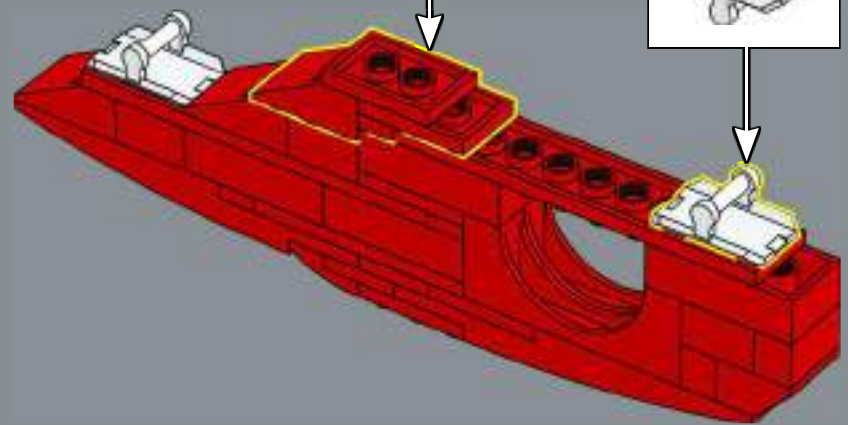
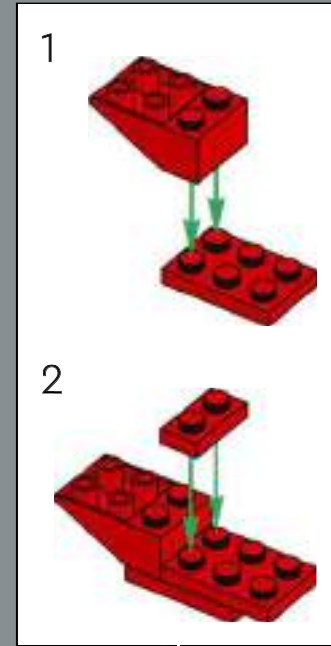

186





Originally designed as a candle, this element now serves as a web line!

187

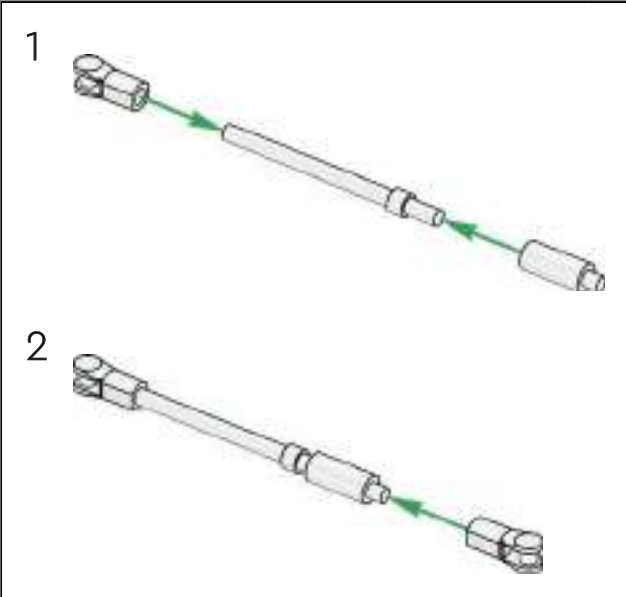
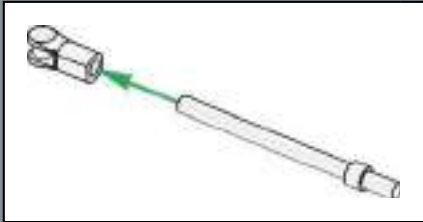

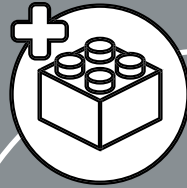

1x

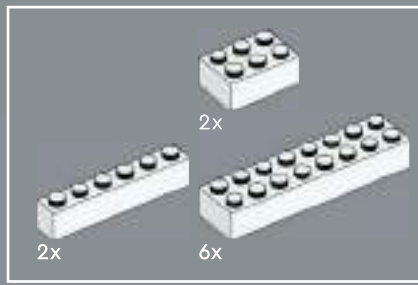

188



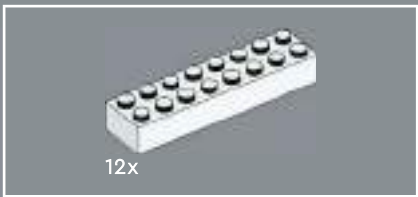

189

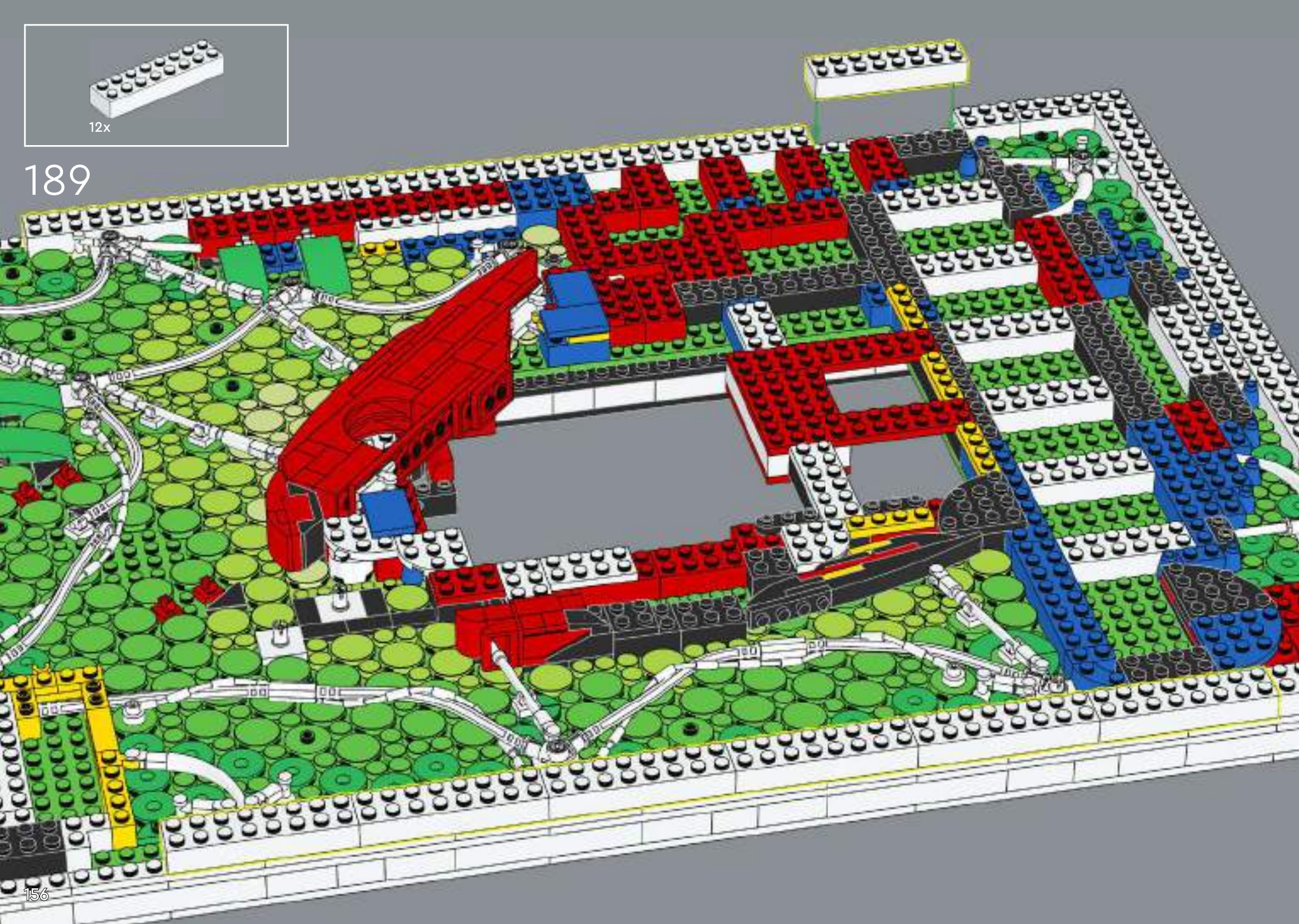

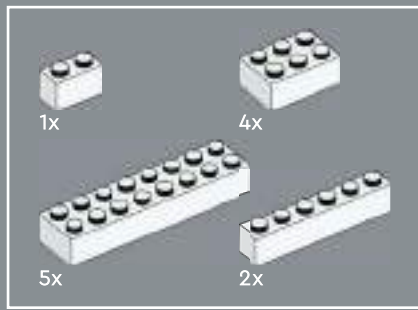

190

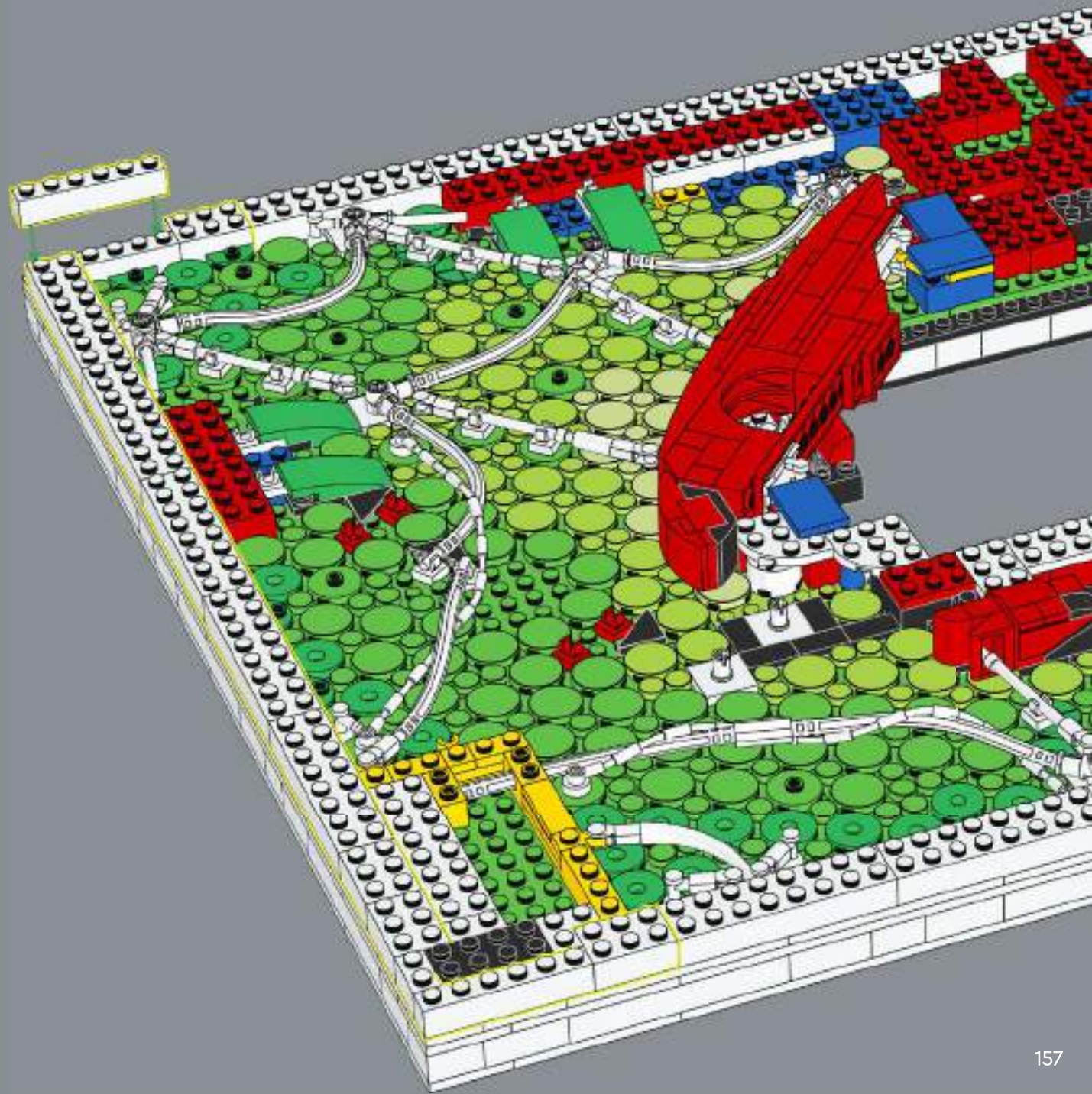



191





192





193





194



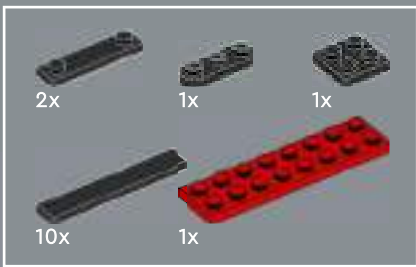

195



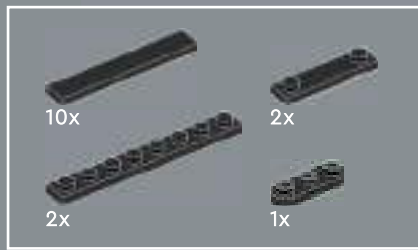

196

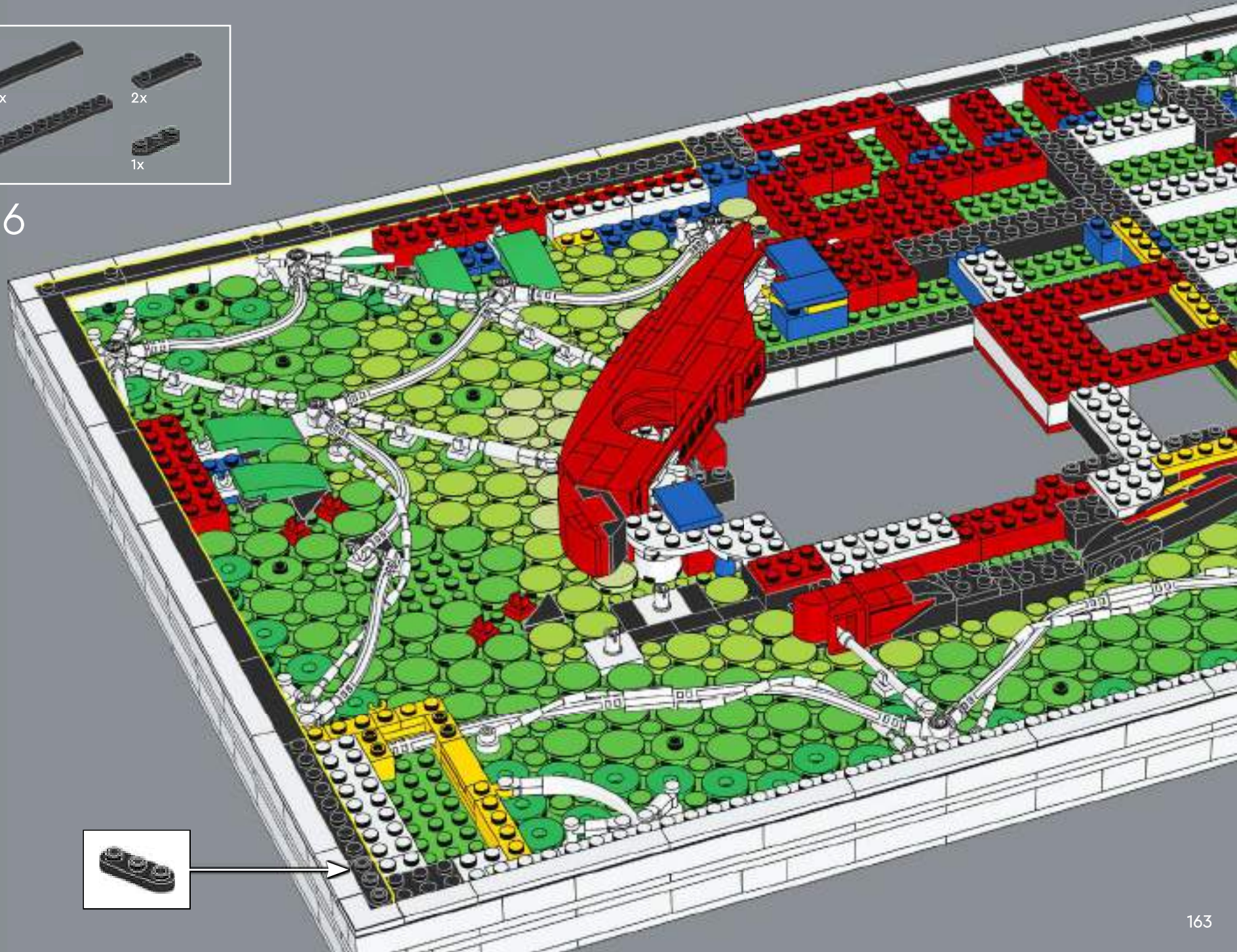



197

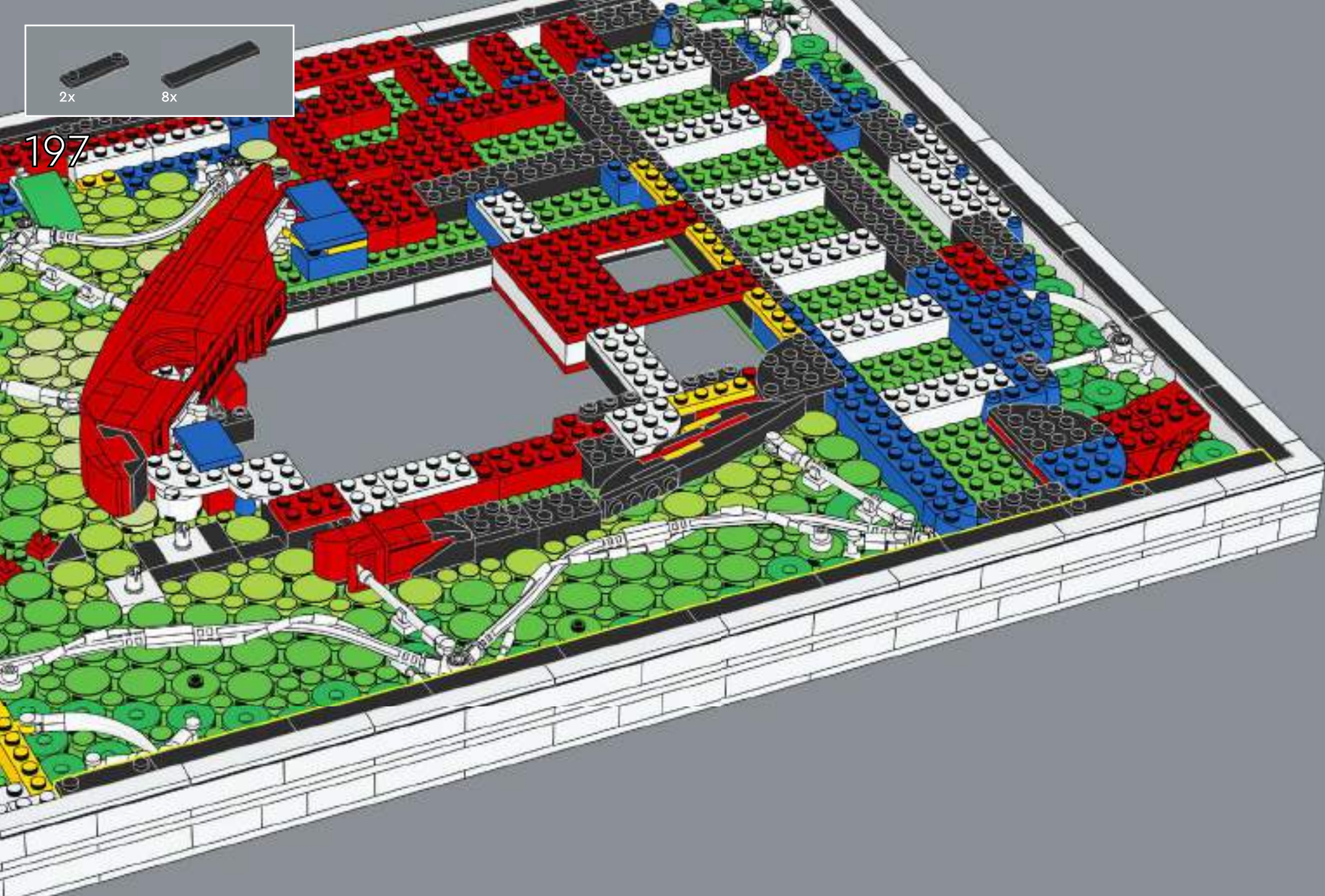

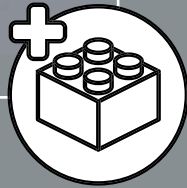
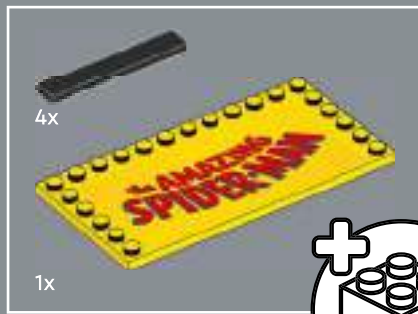

198

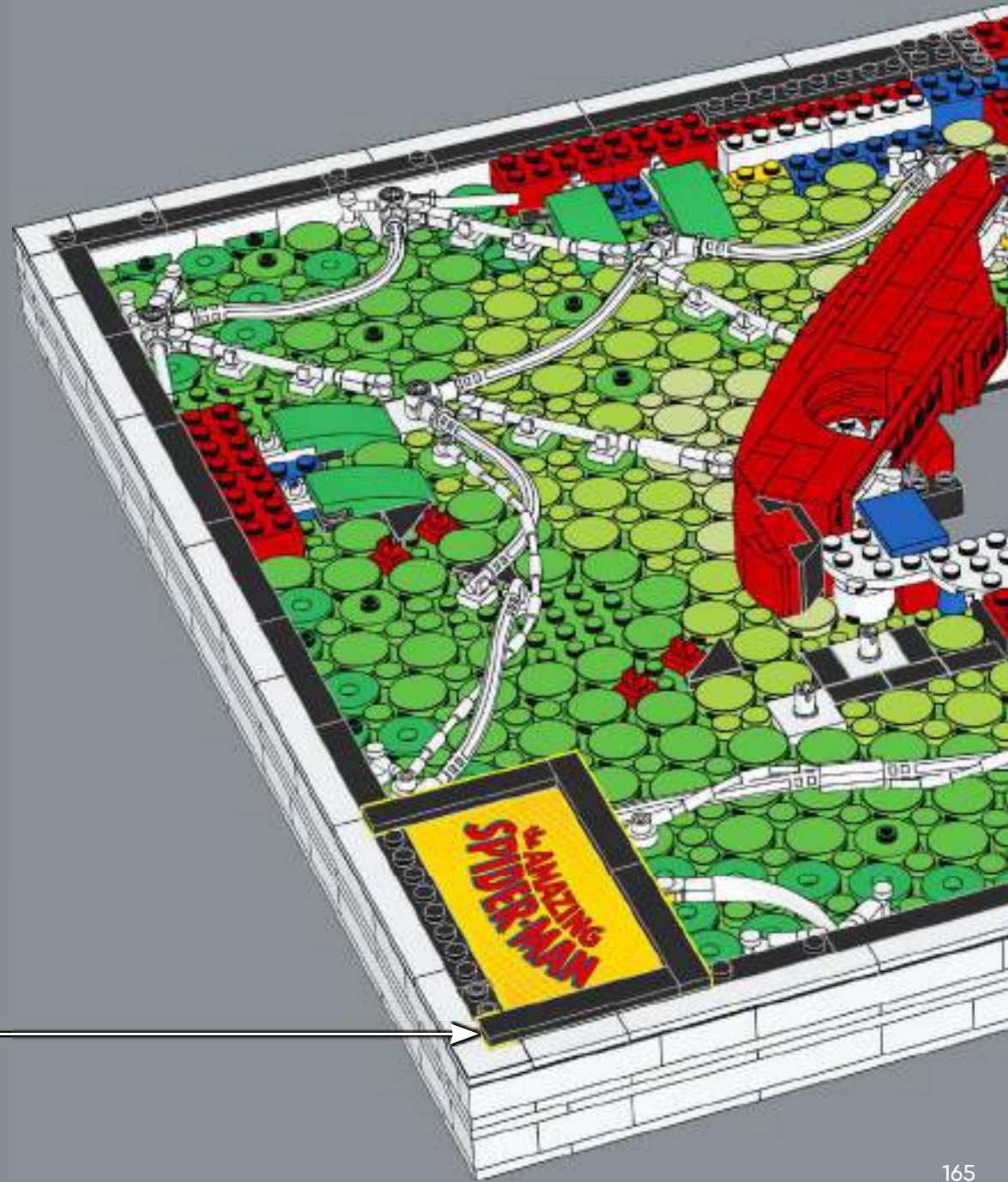



199

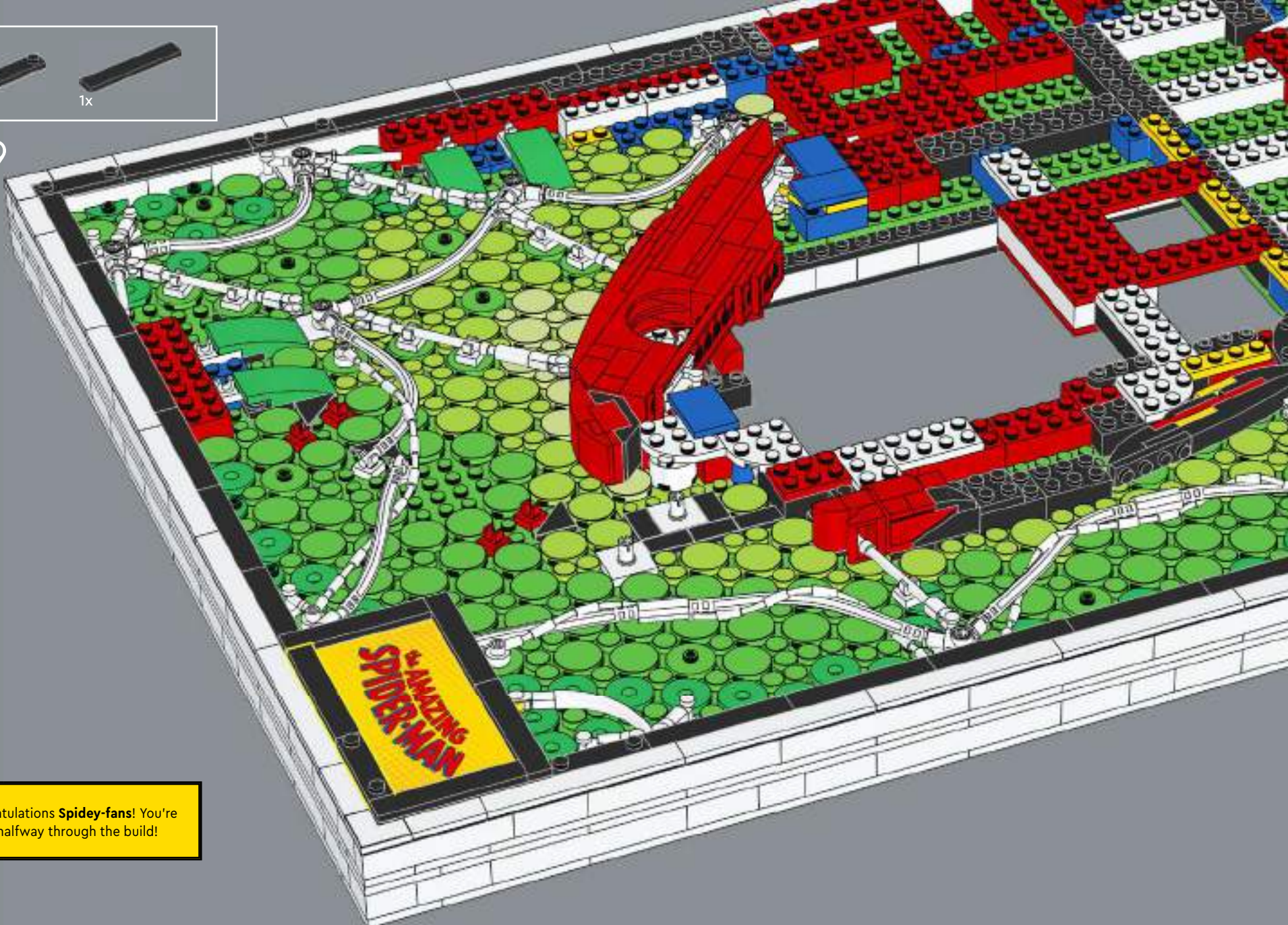

Congratulations **Spidey-fans!** You're about halfway through the build!



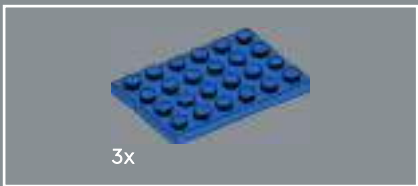

200

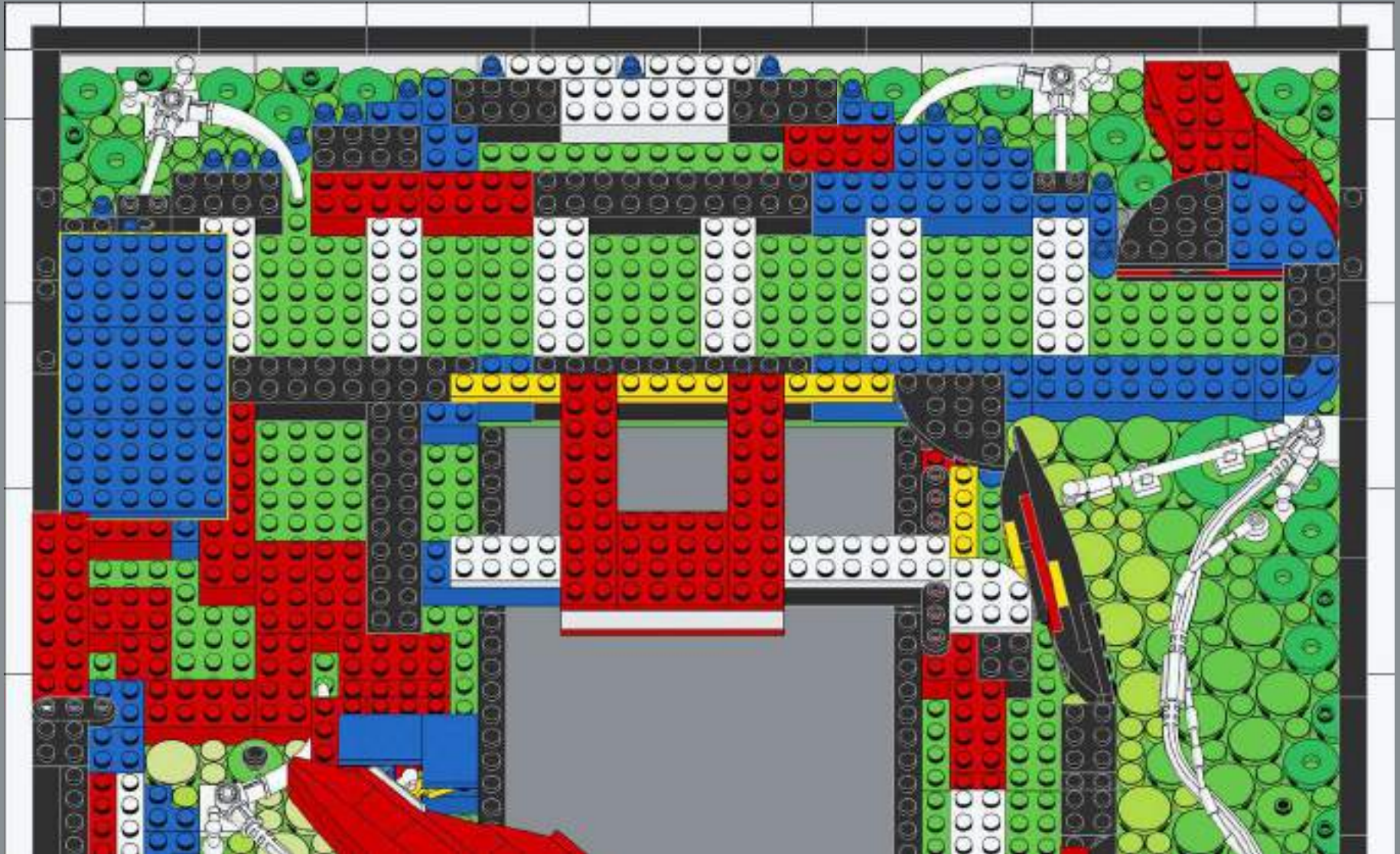



5x

201

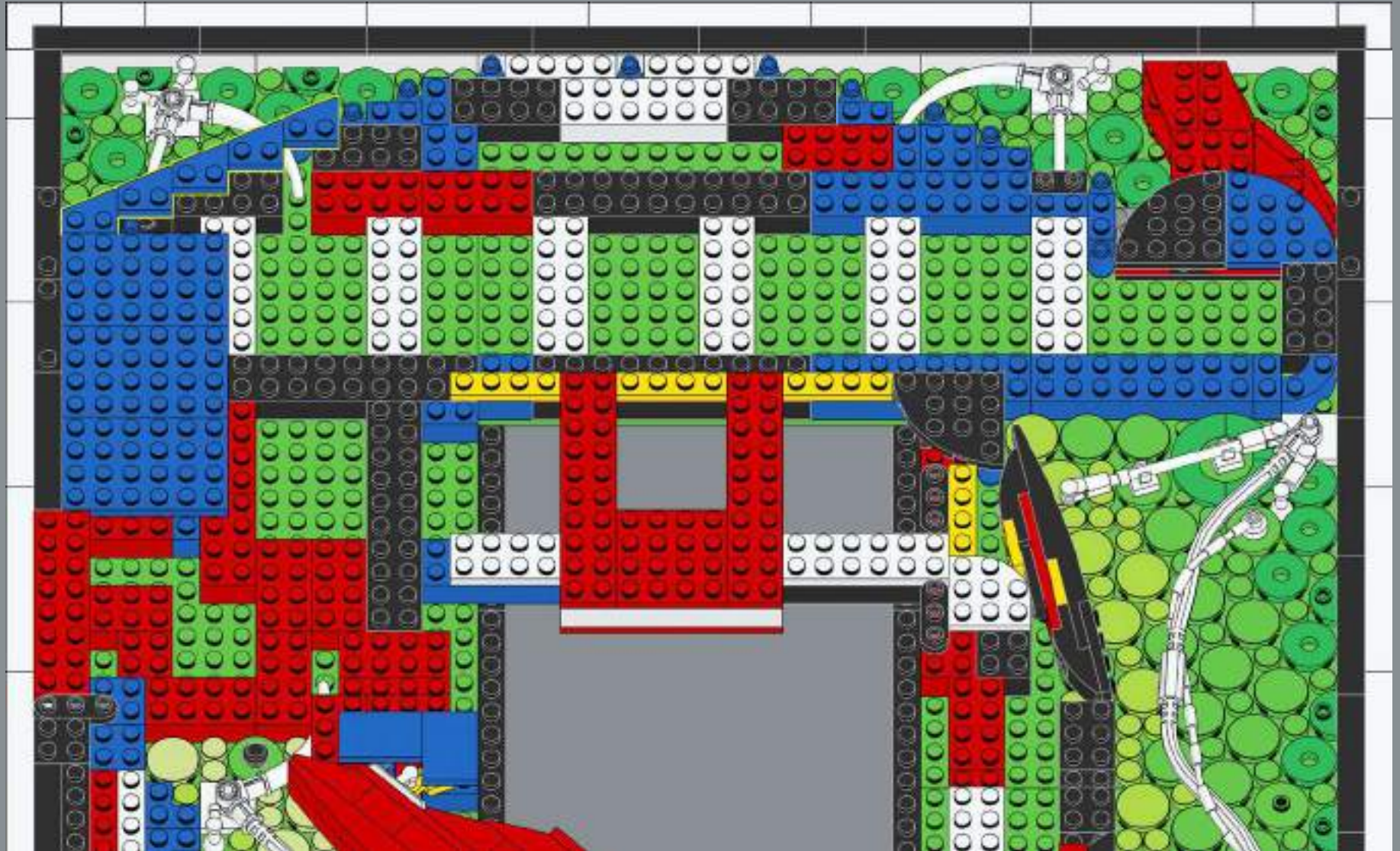

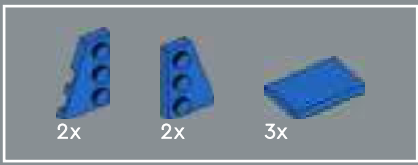

202

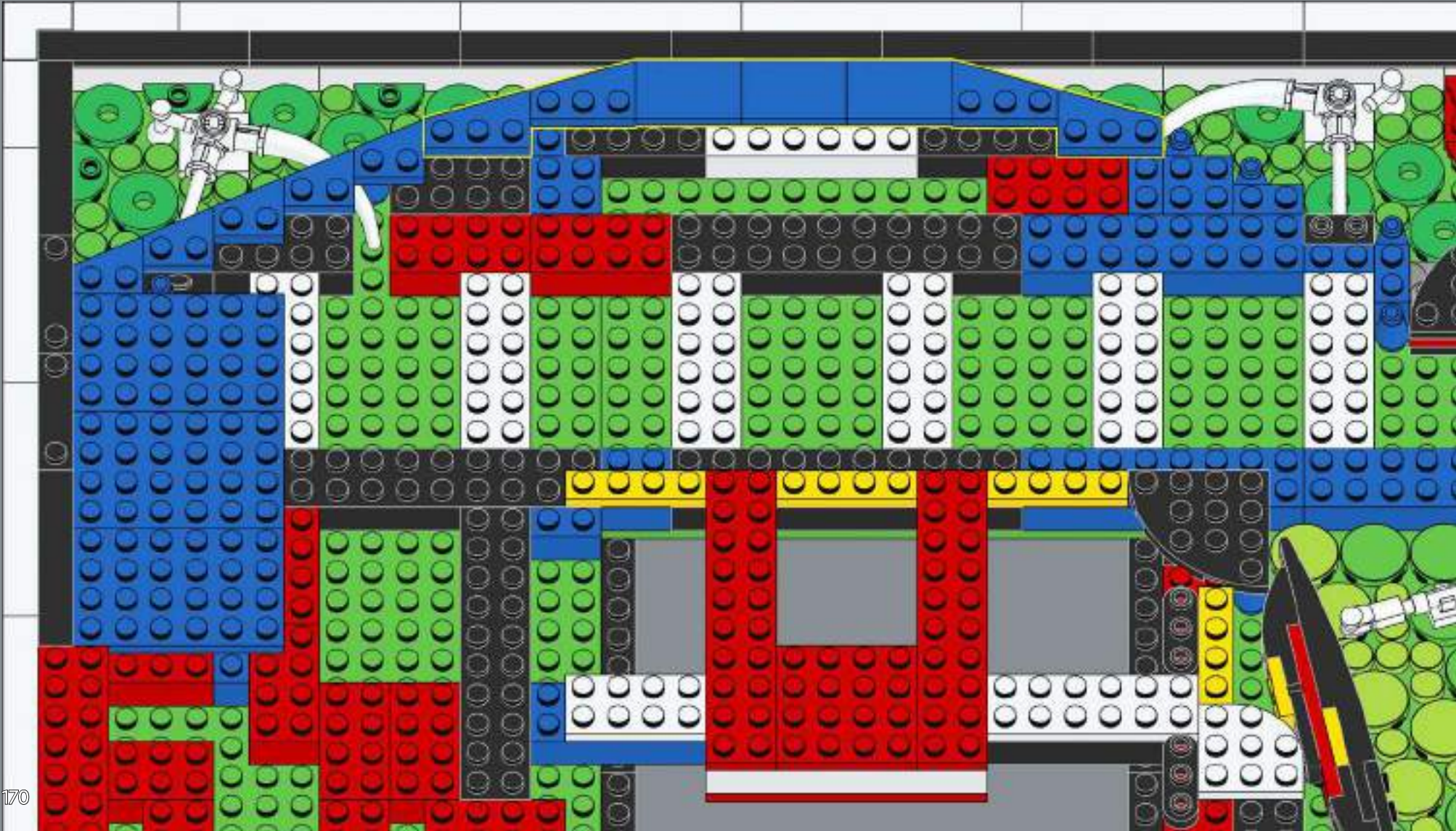



203

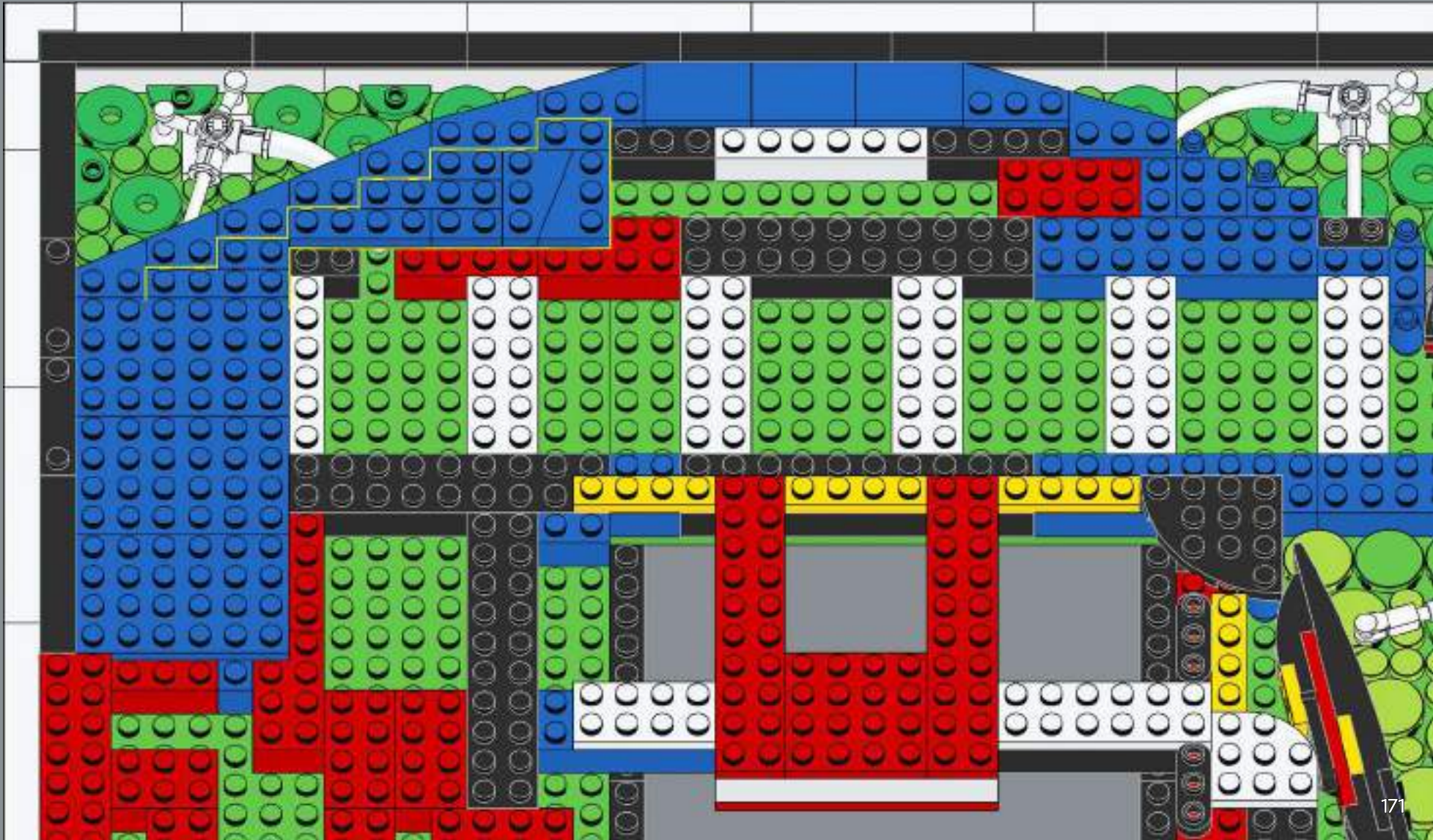

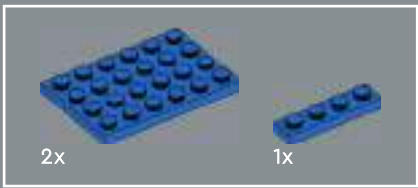

204

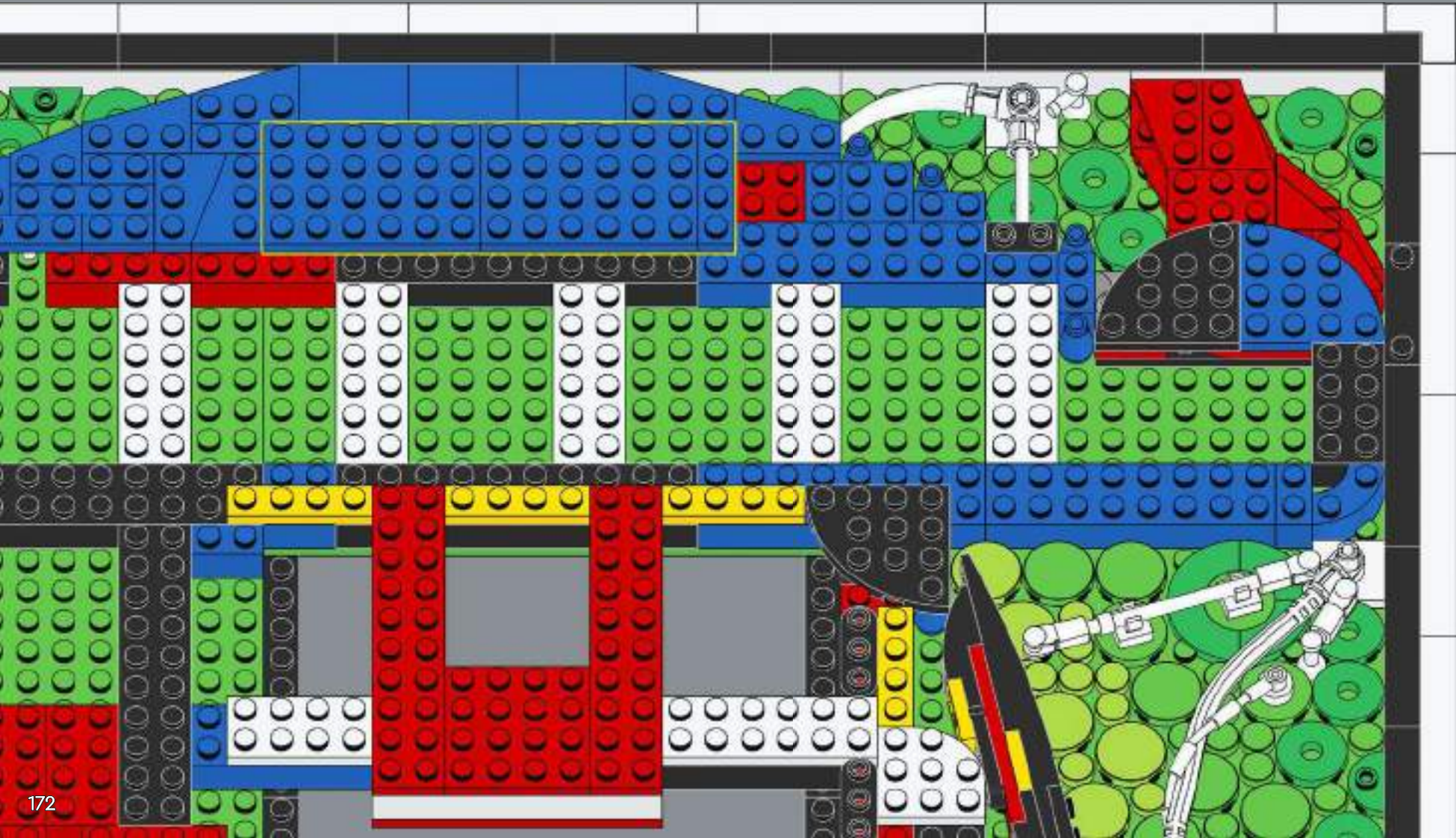

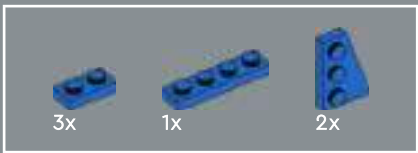

206



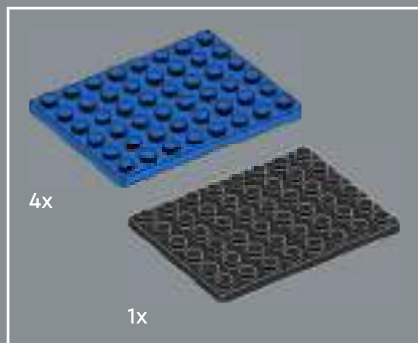

207

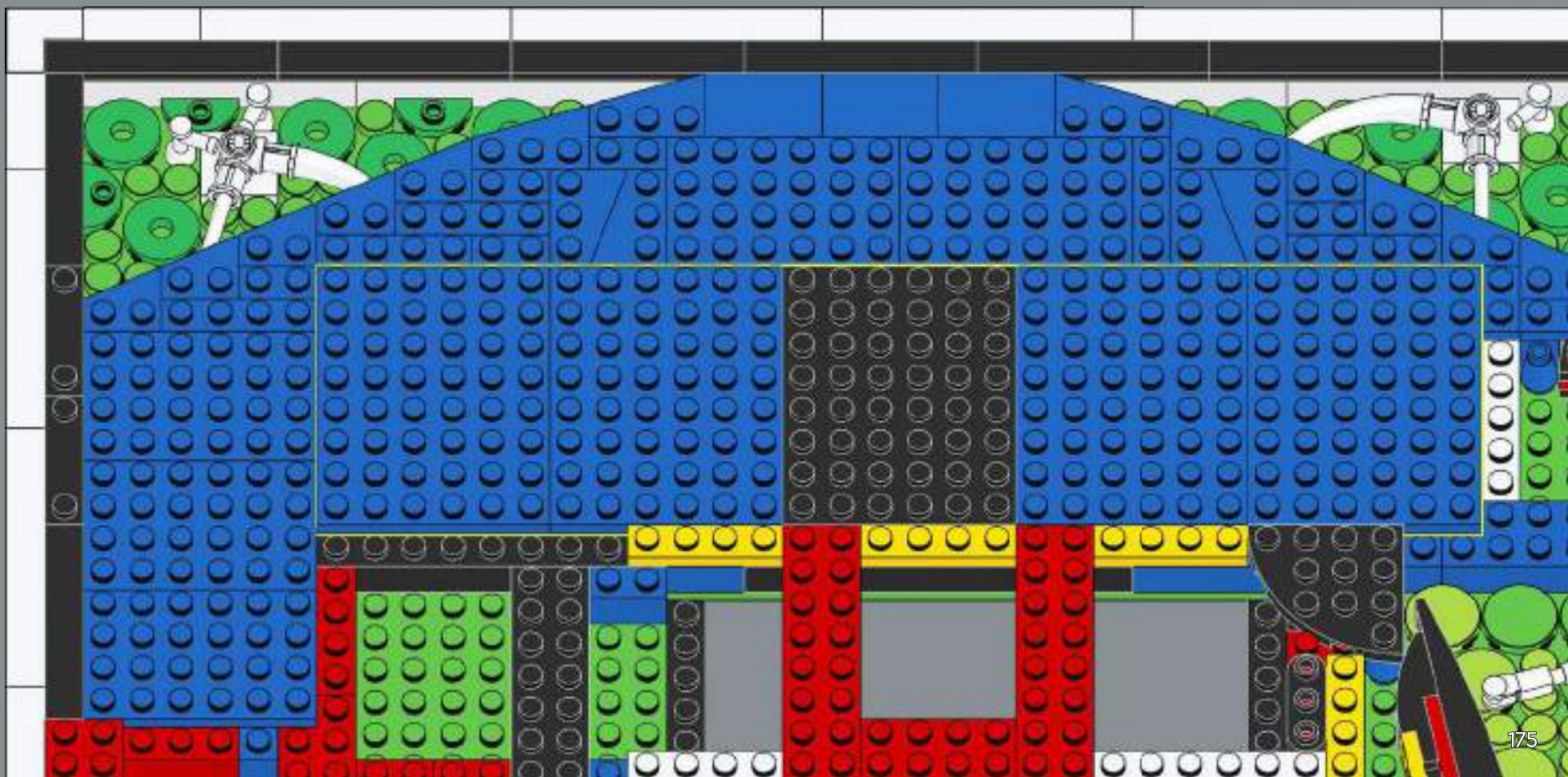

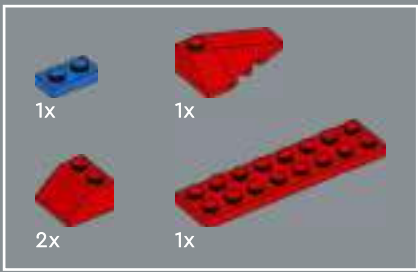

Did you know? Spider-Man was originally intended to have an **orange and purple costume**, but it was switched to the iconic **red and blue** because it would print cleaner on pulp paper.

210

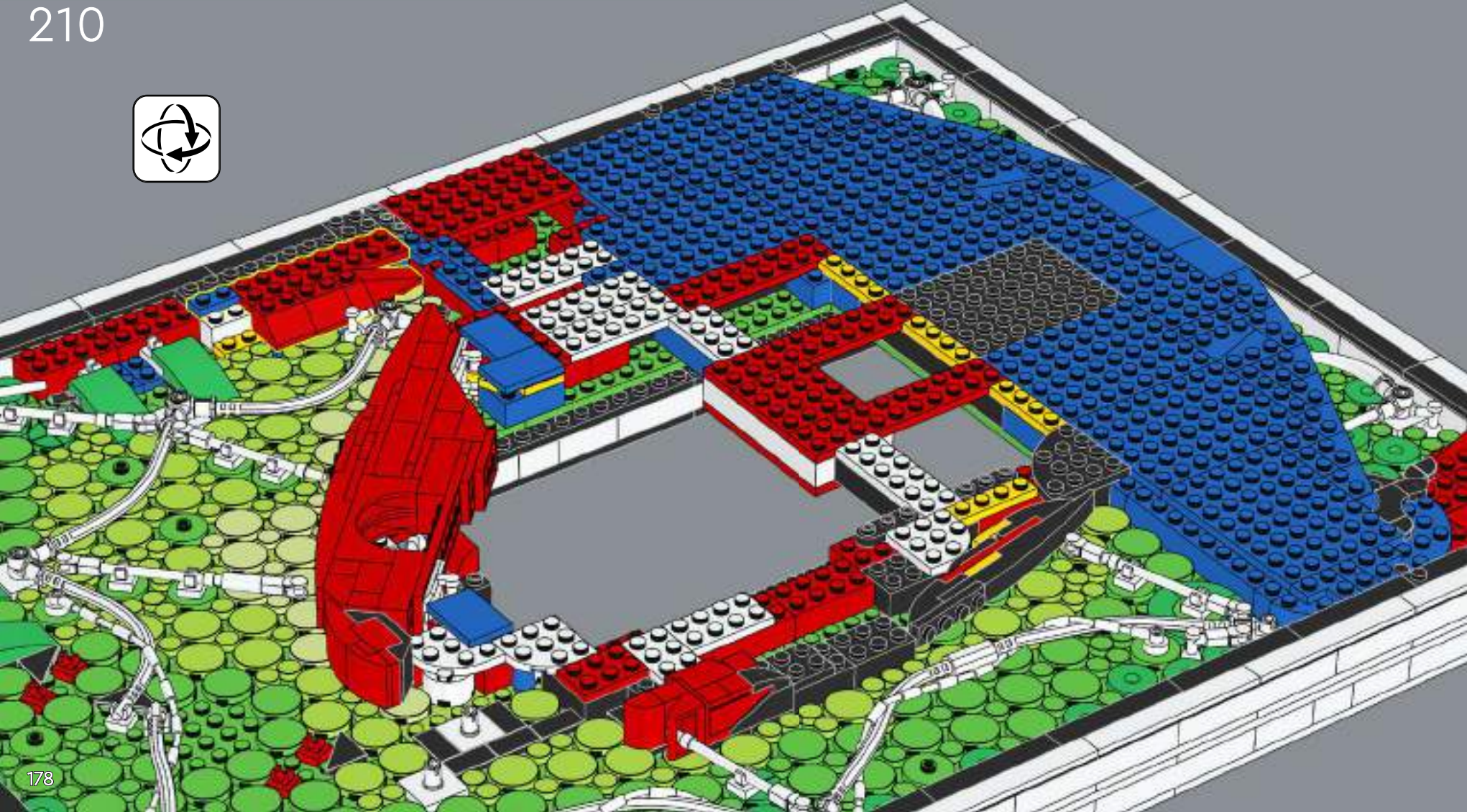

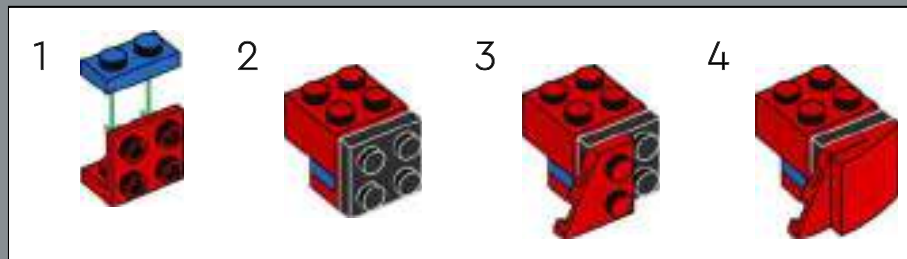
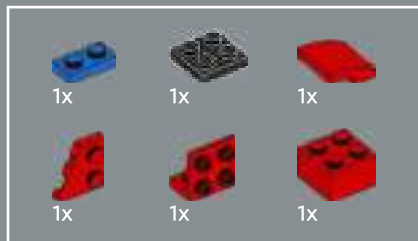

211

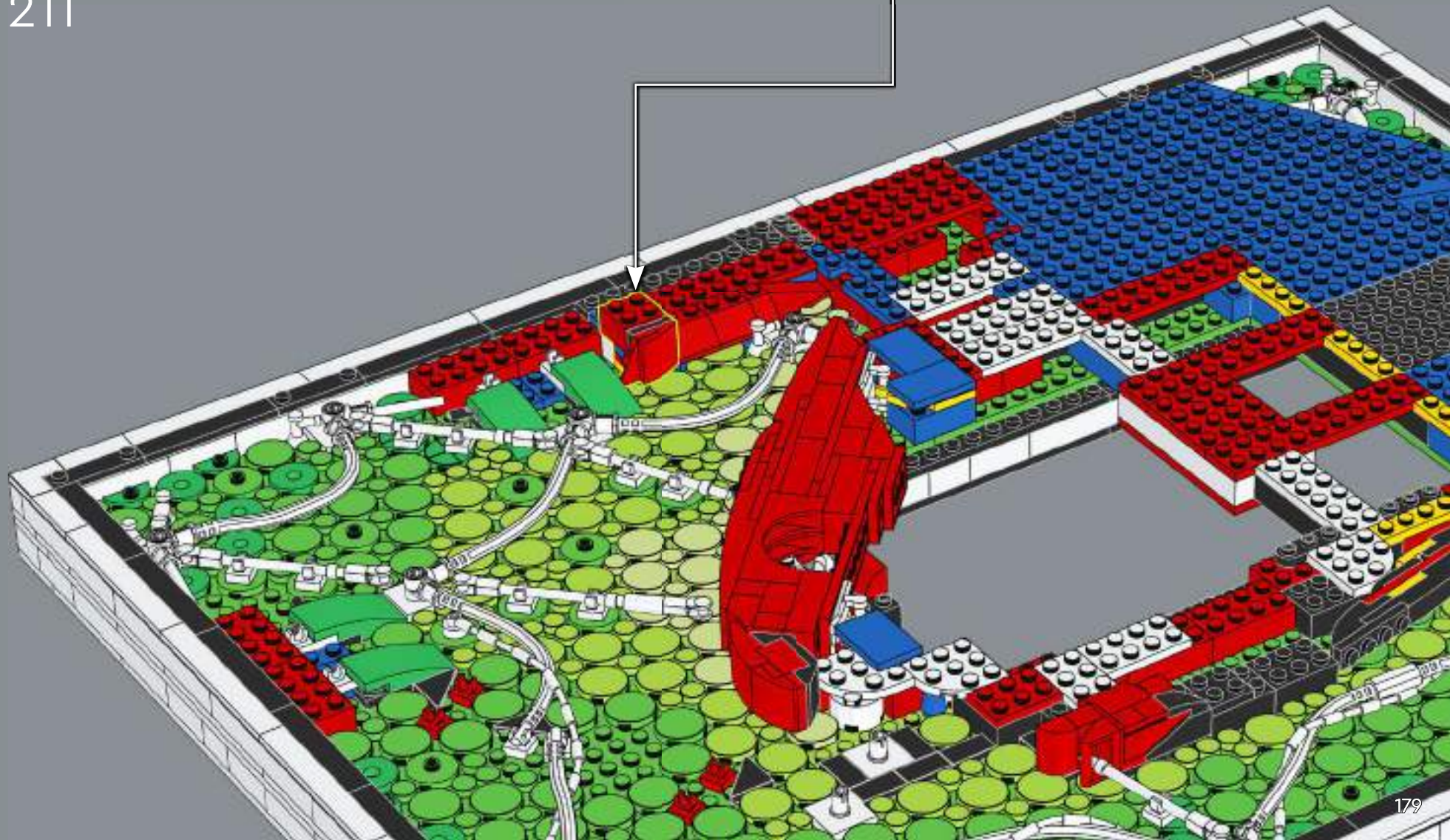

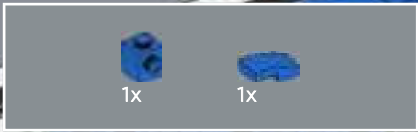

212

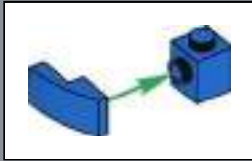

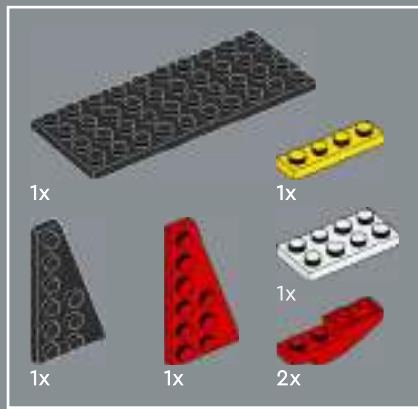

213

1

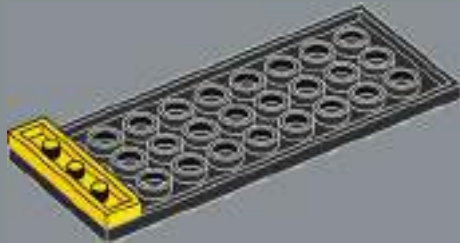

2

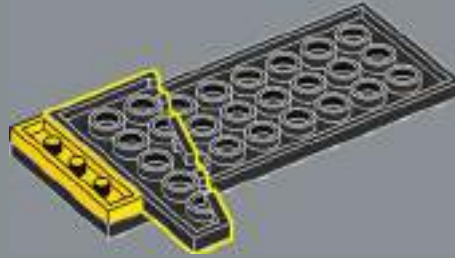

3

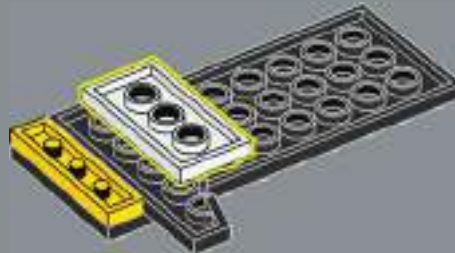

4

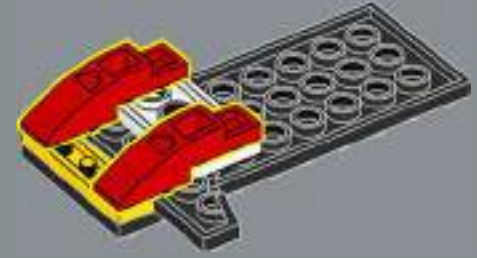

5

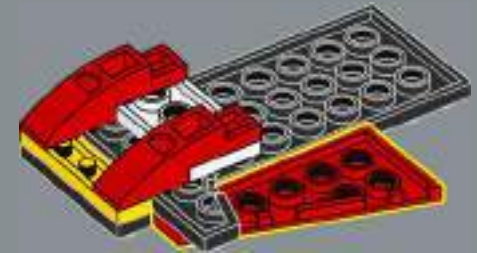



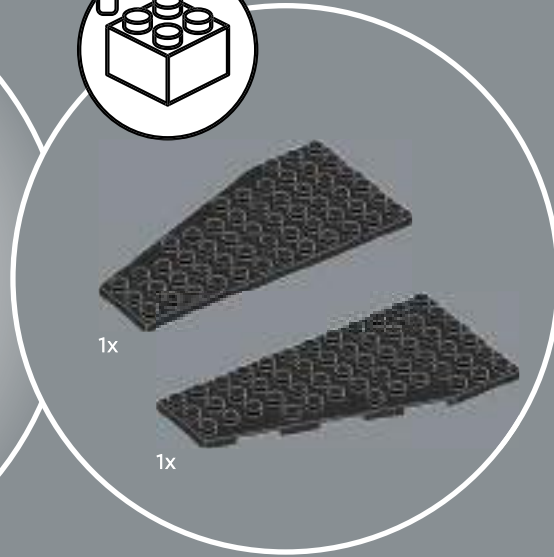
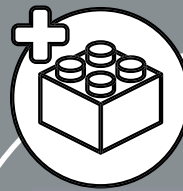



214



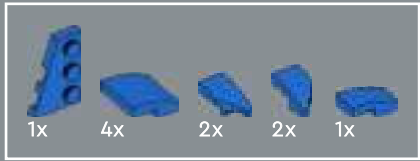

215

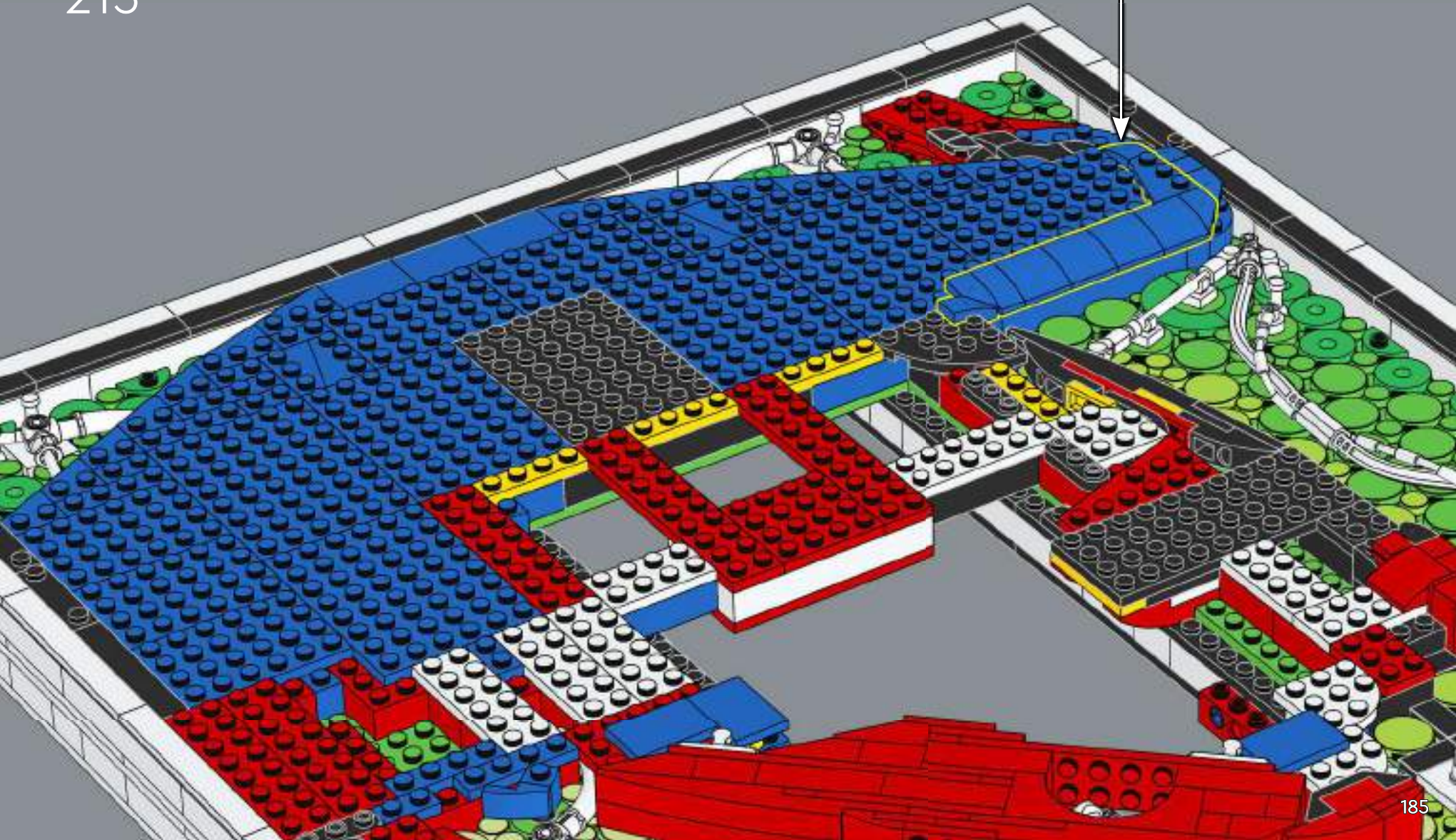

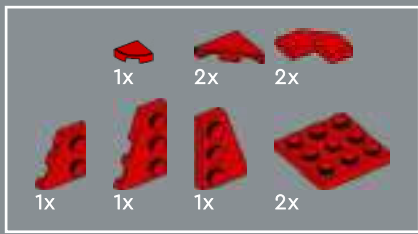

216

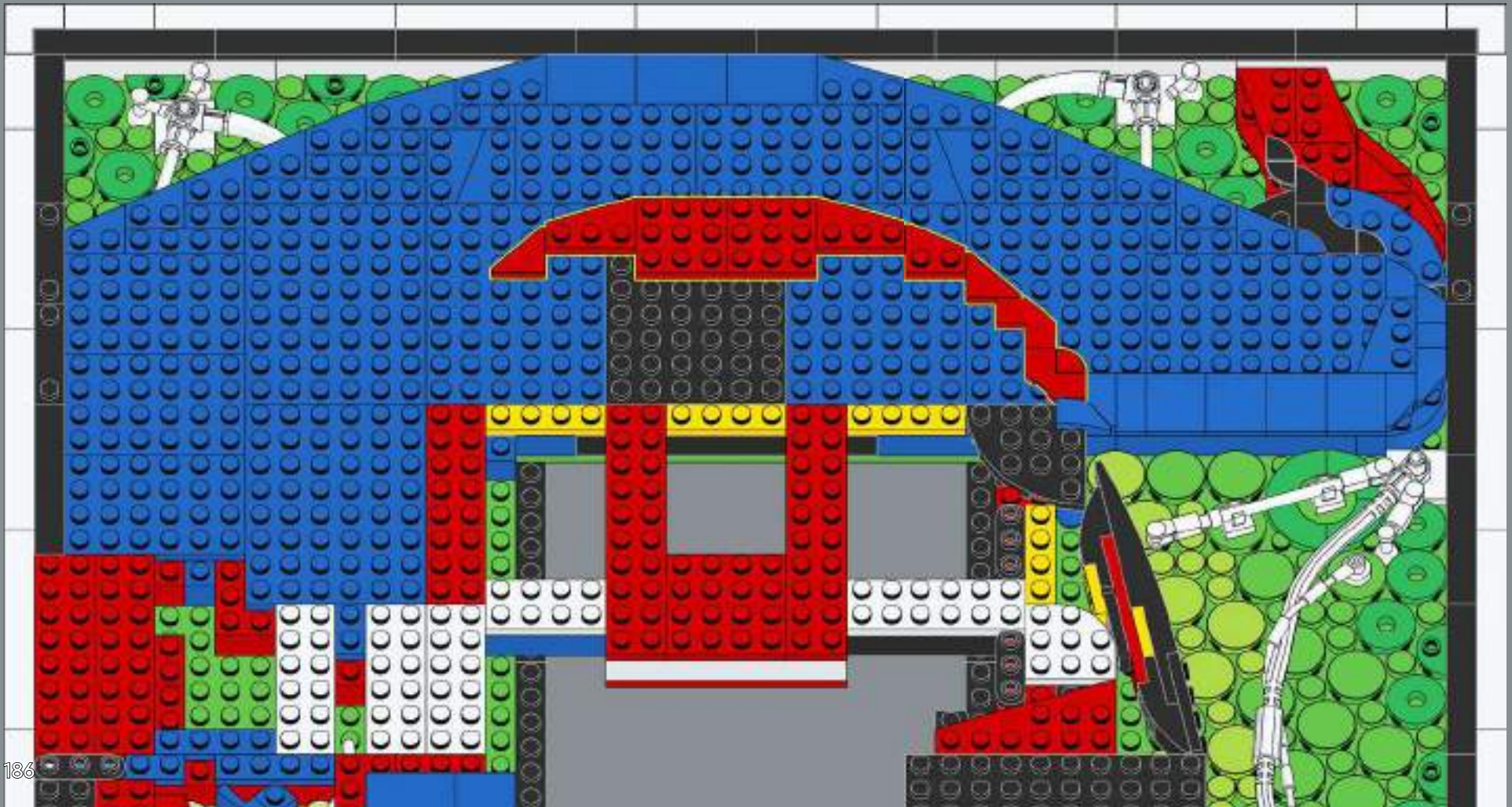

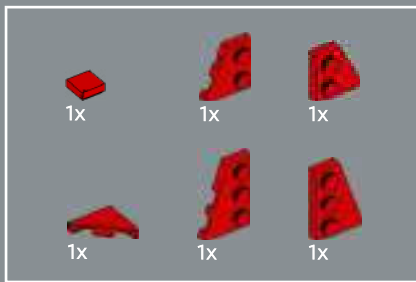

Did you know? Spider-Man stores extra web fluid cartridges on his belt. The actual belt is tucked beneath his costume, so they don't get lost!

217





218

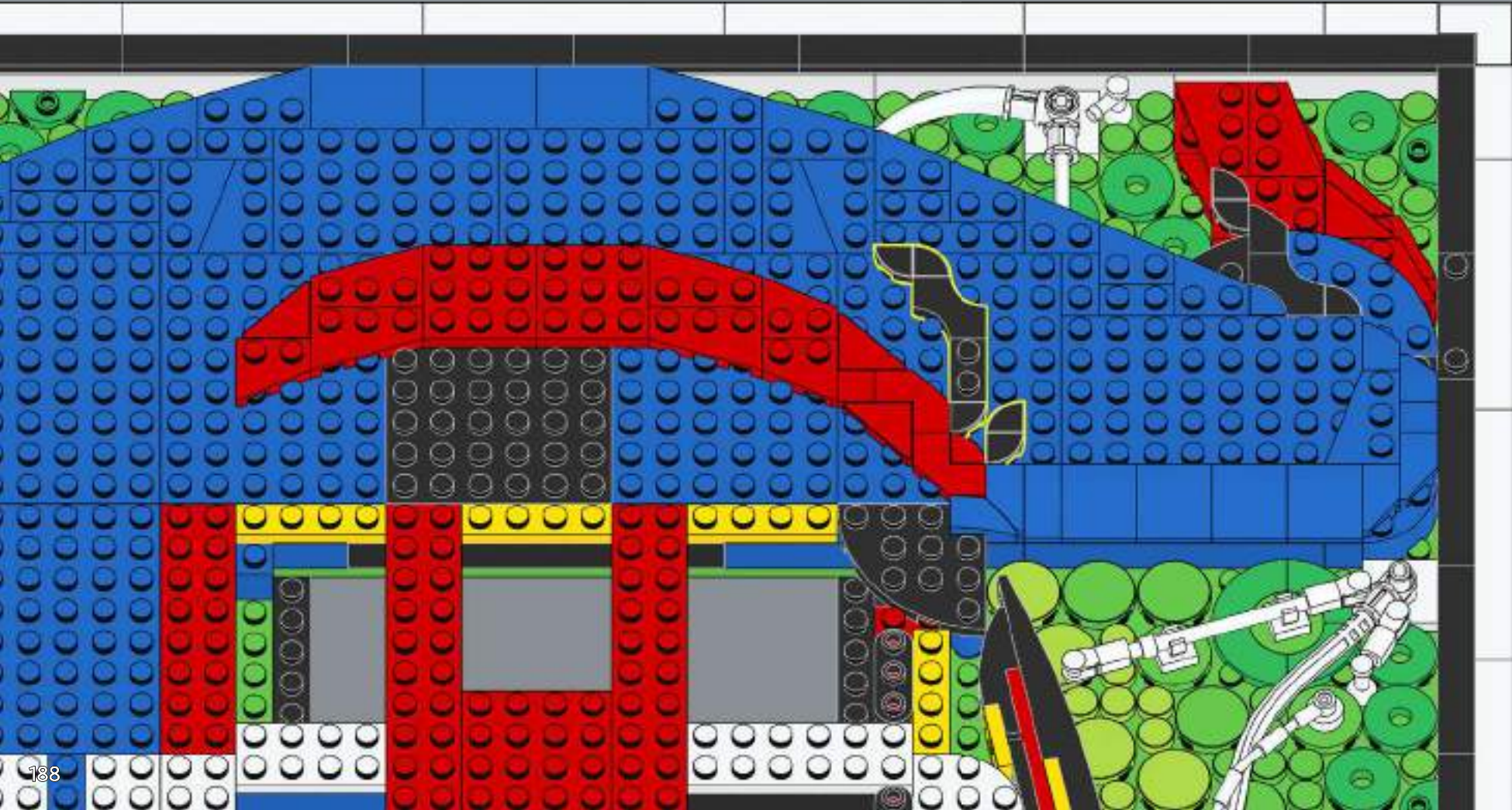

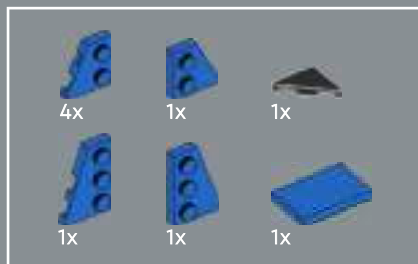

219



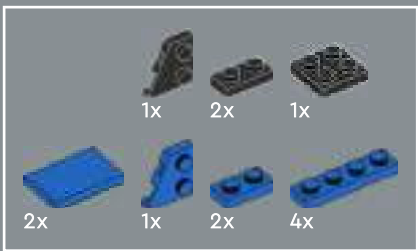

220

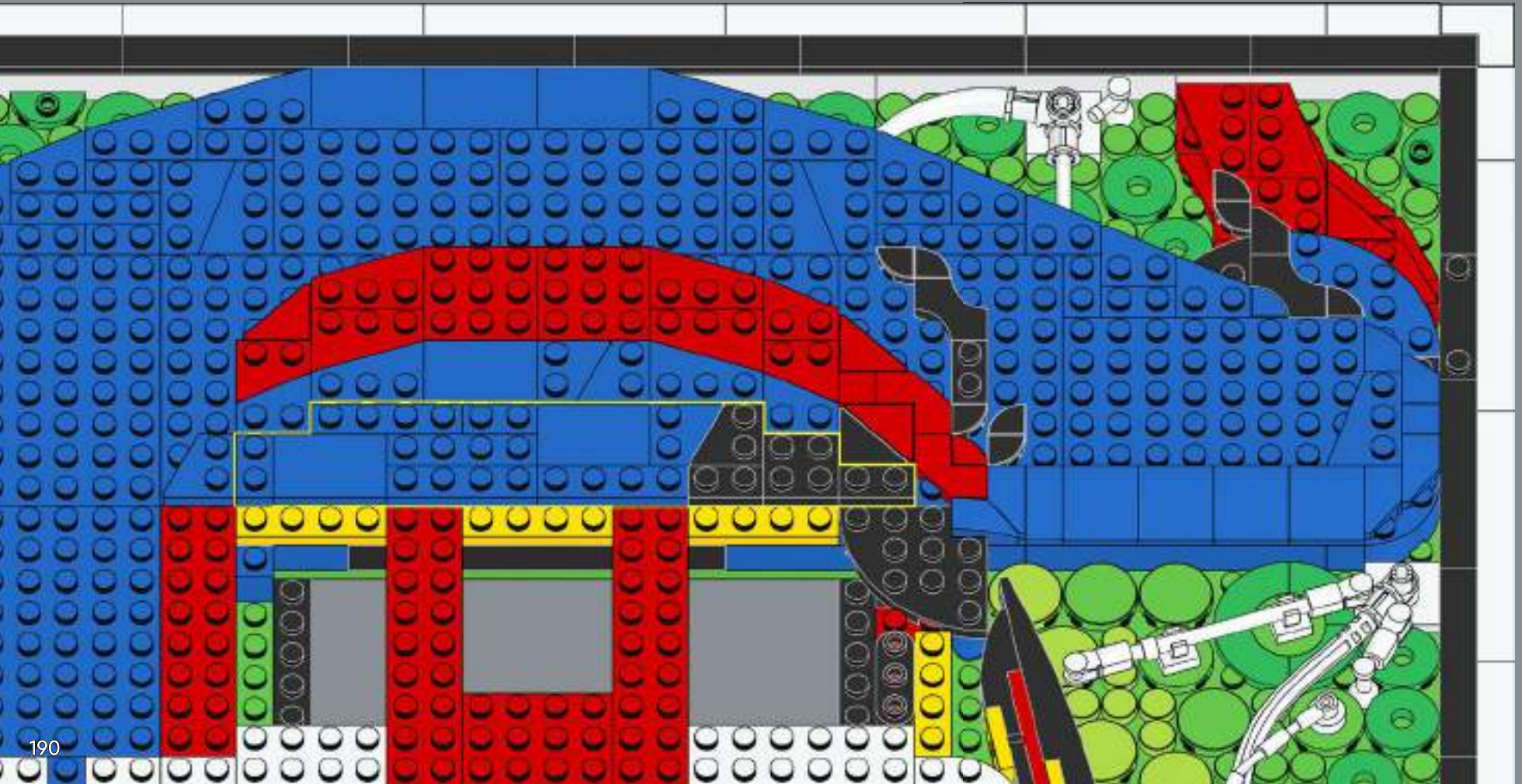

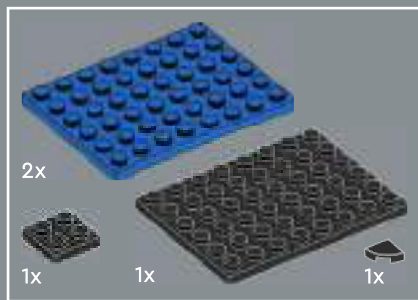

221

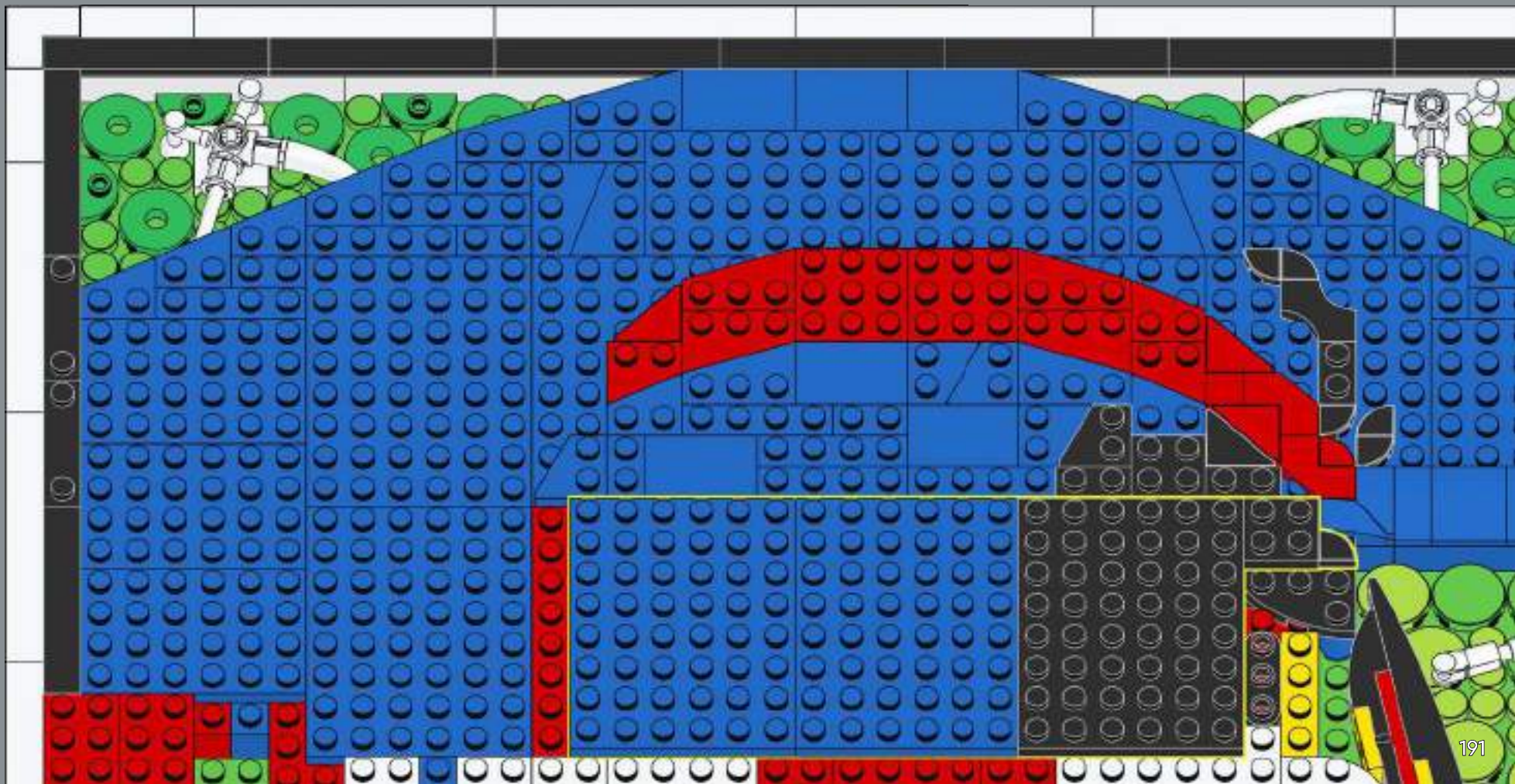

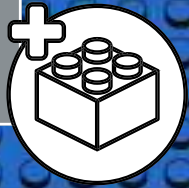
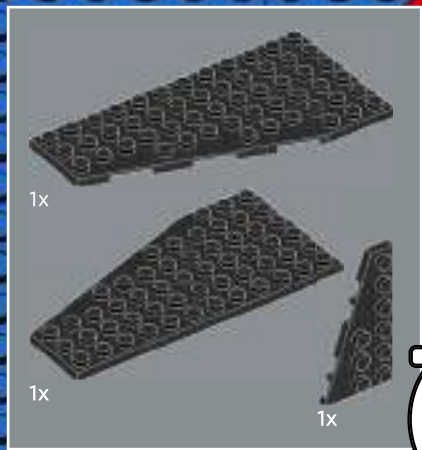

222



223



224

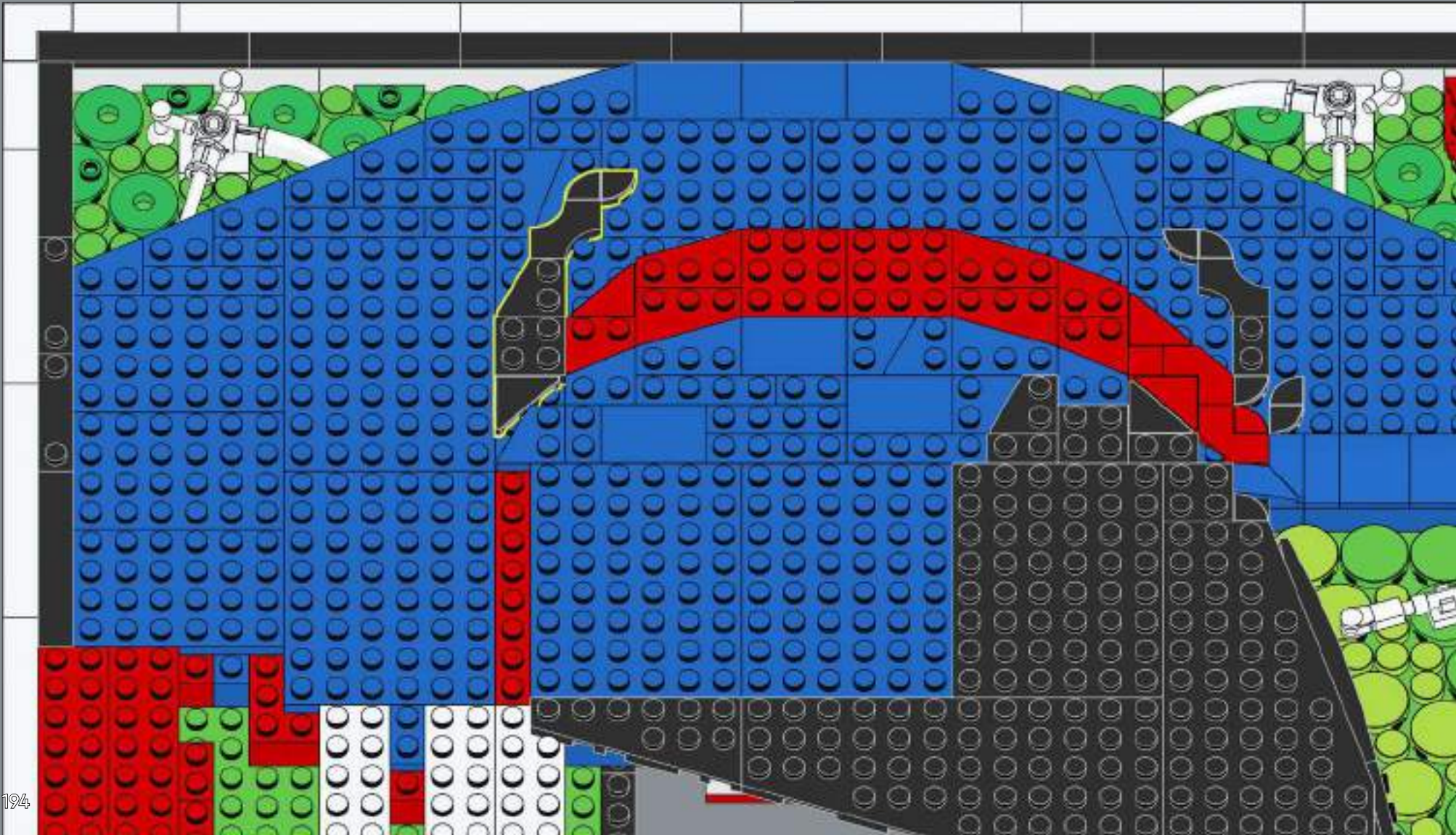



225

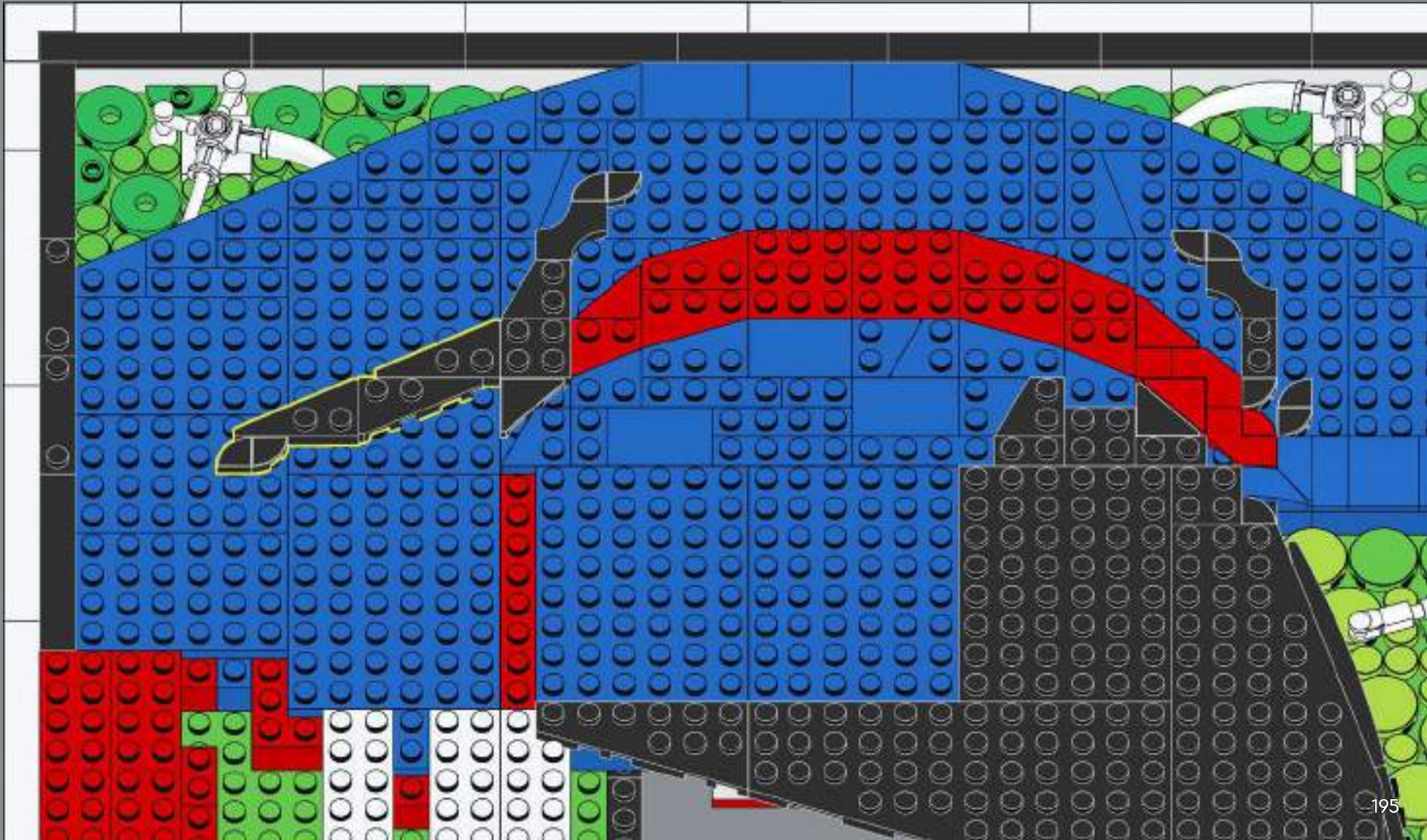

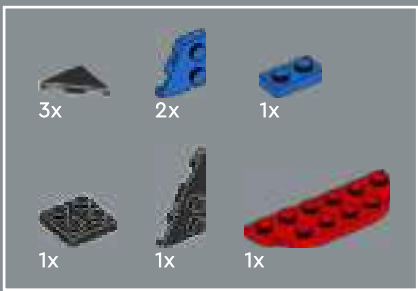

226

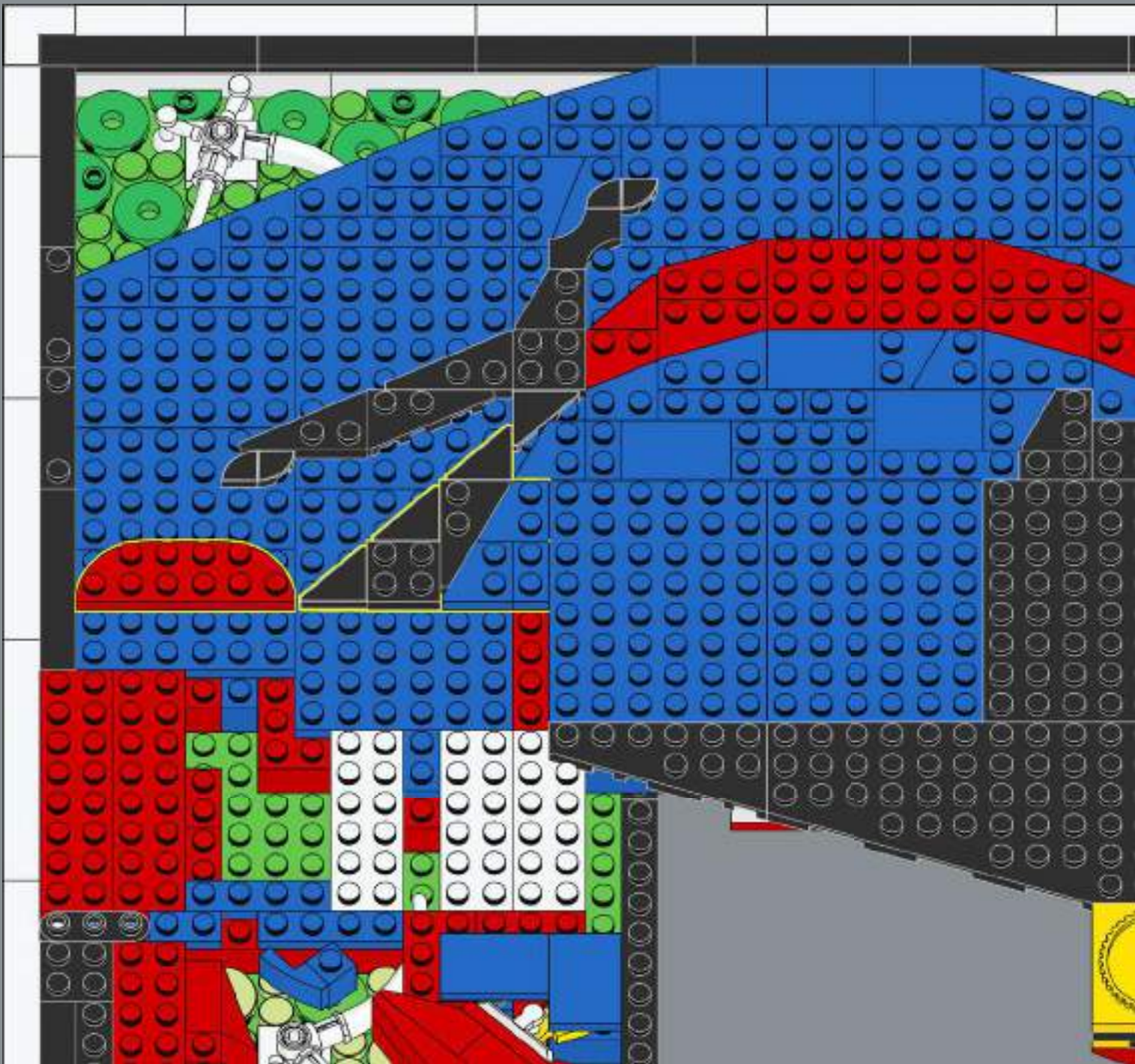

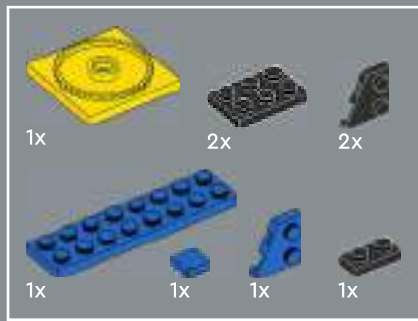

227

The placement of these yellow turntables is important! Precisely **18 across** and **3 up** ...

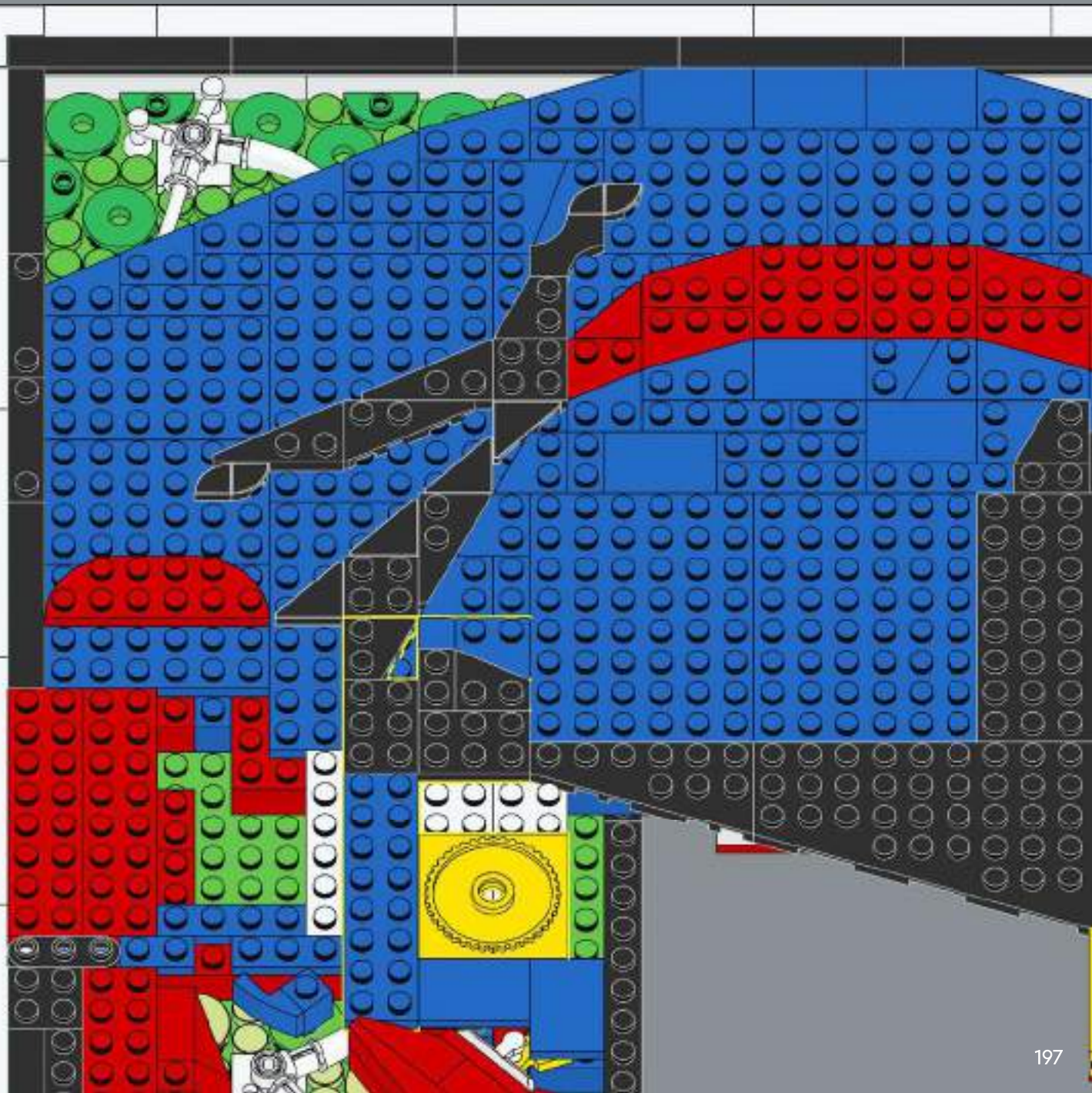

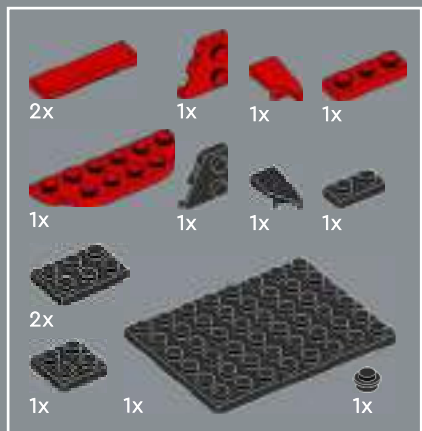

228



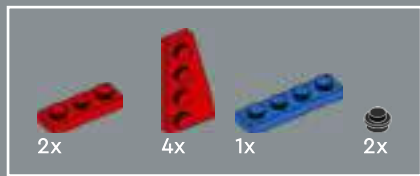

229

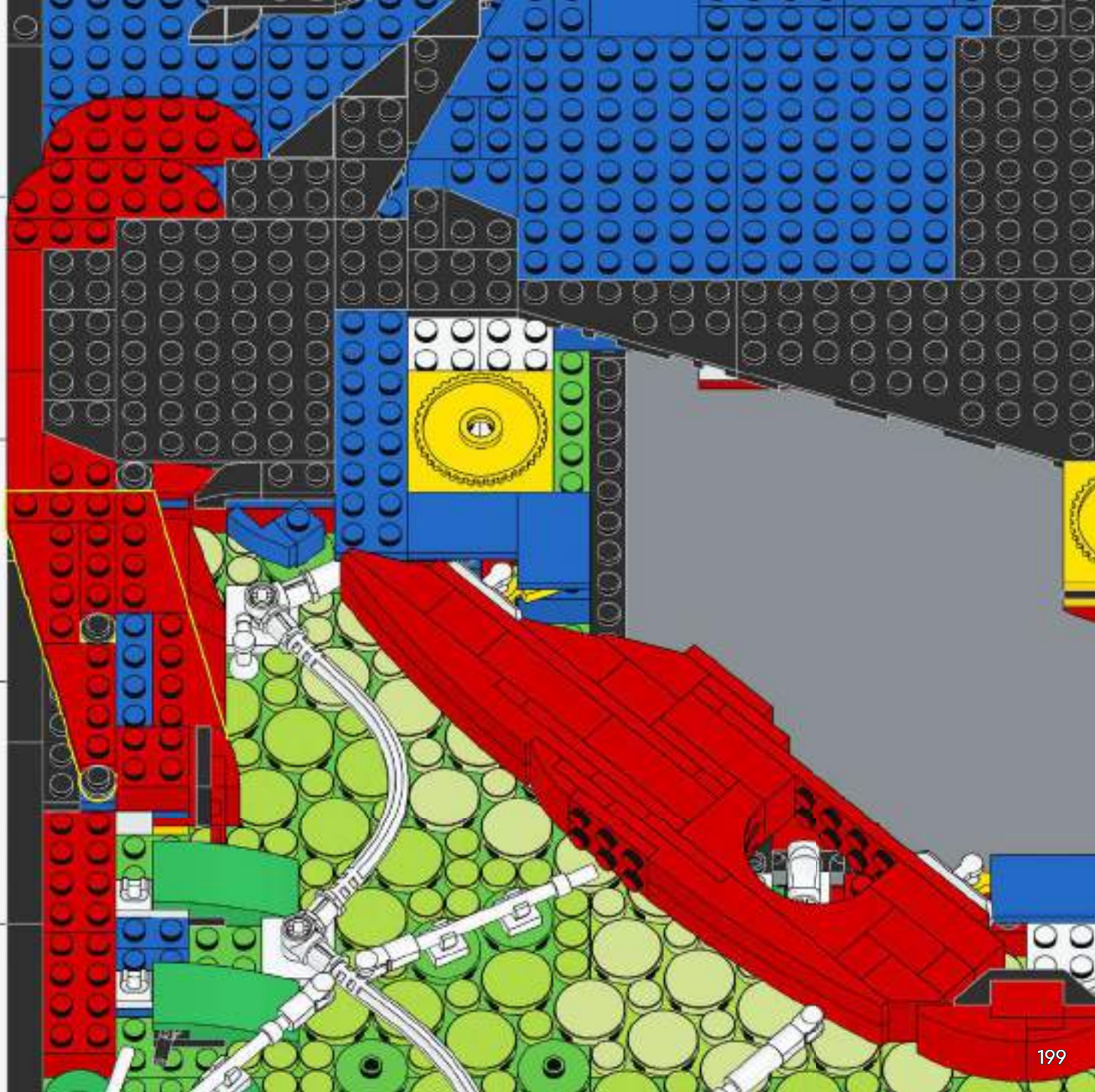





230





231

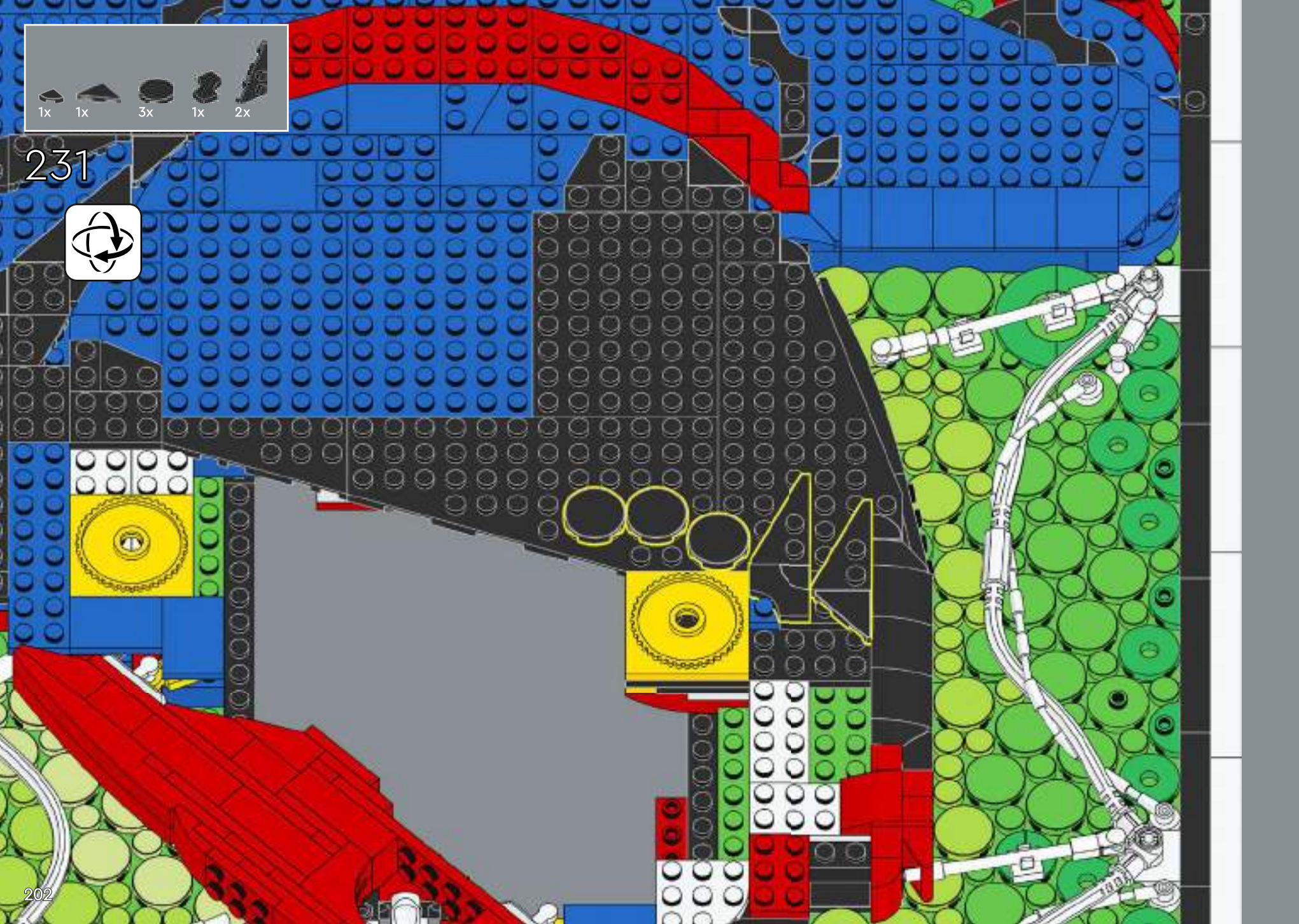

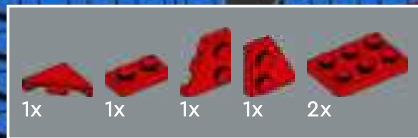

232

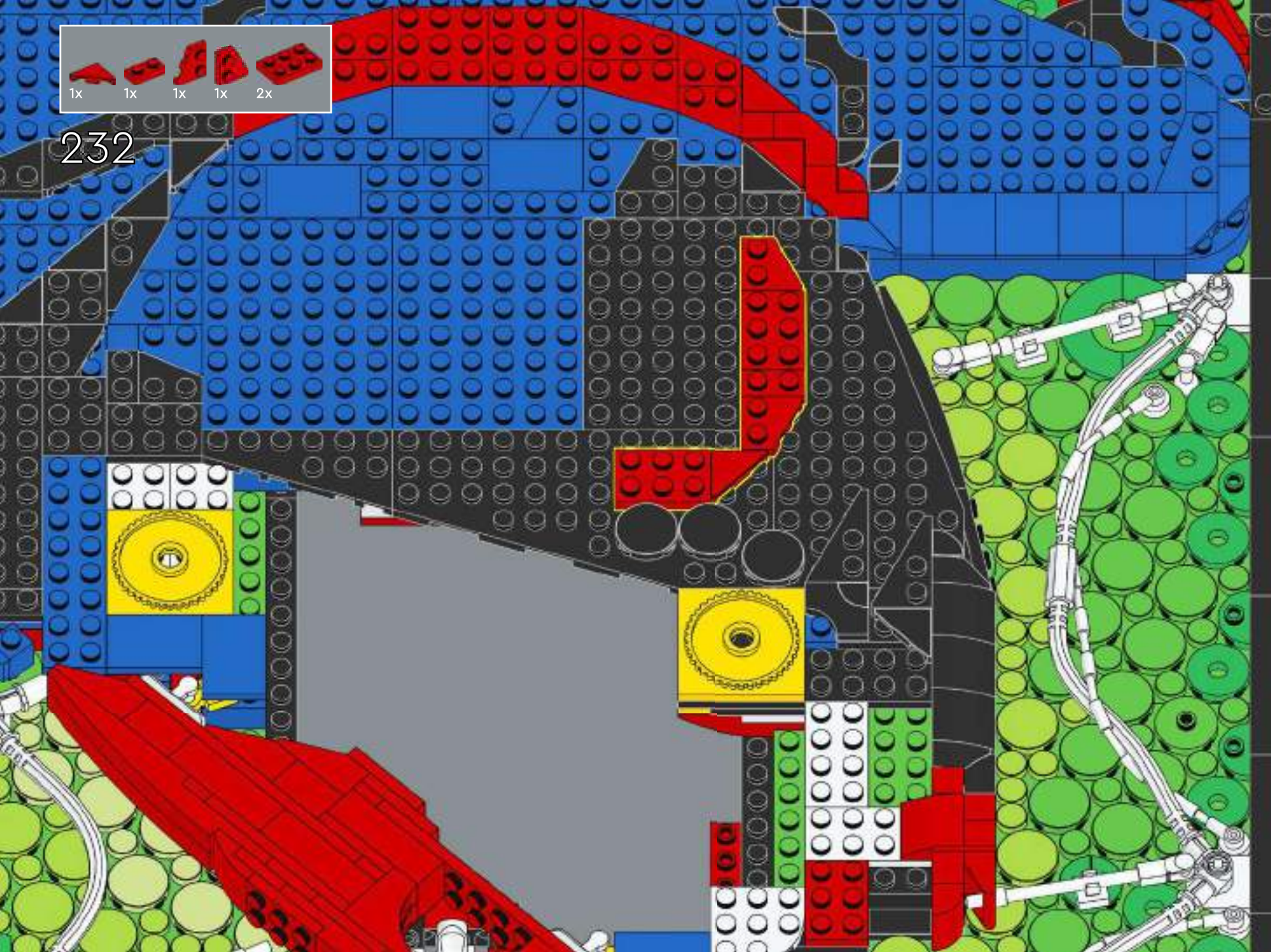

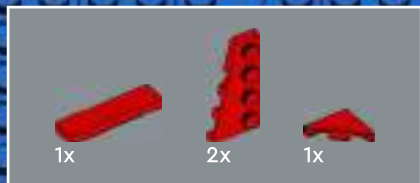

233

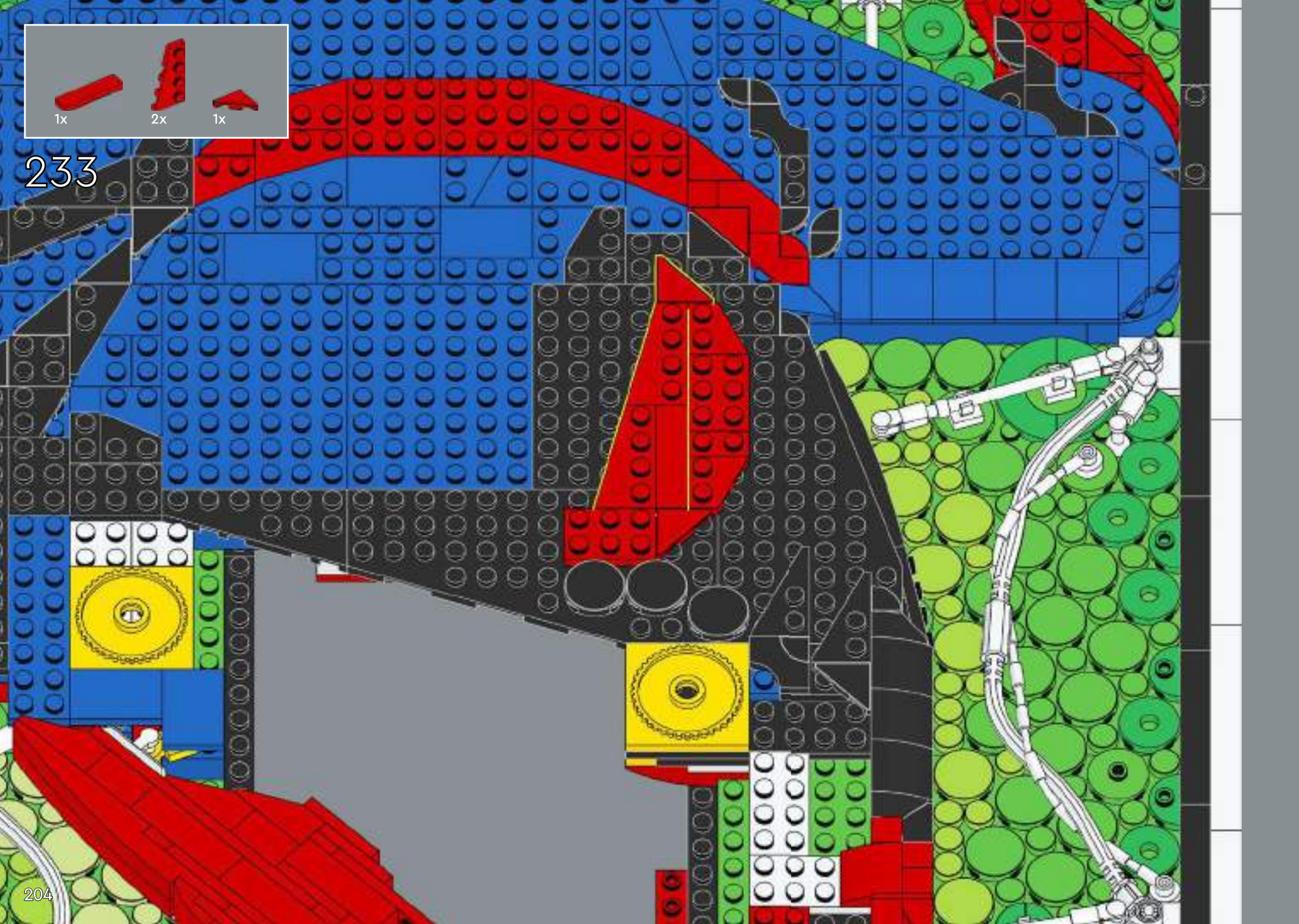



234





235

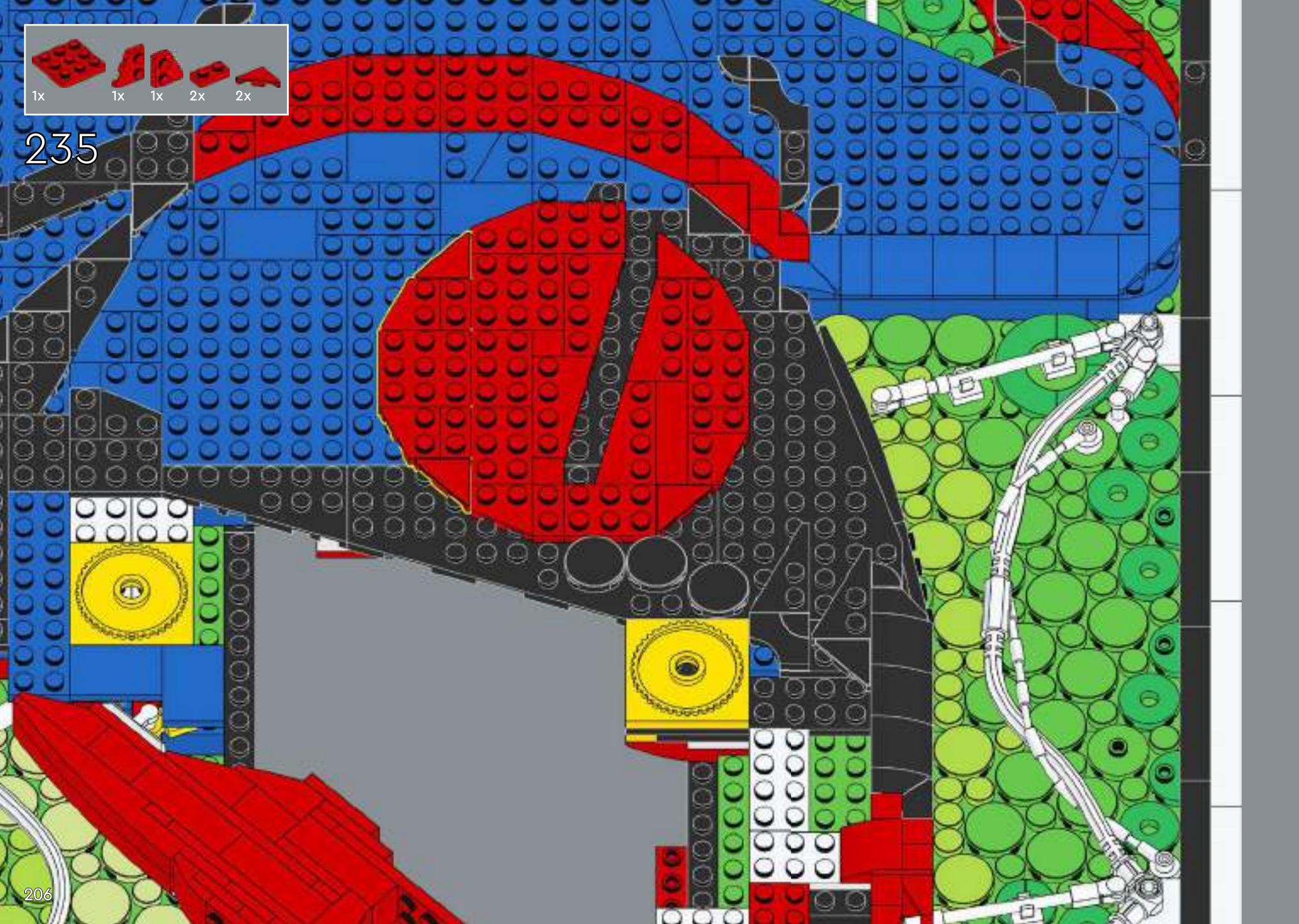

1x  3x 

236

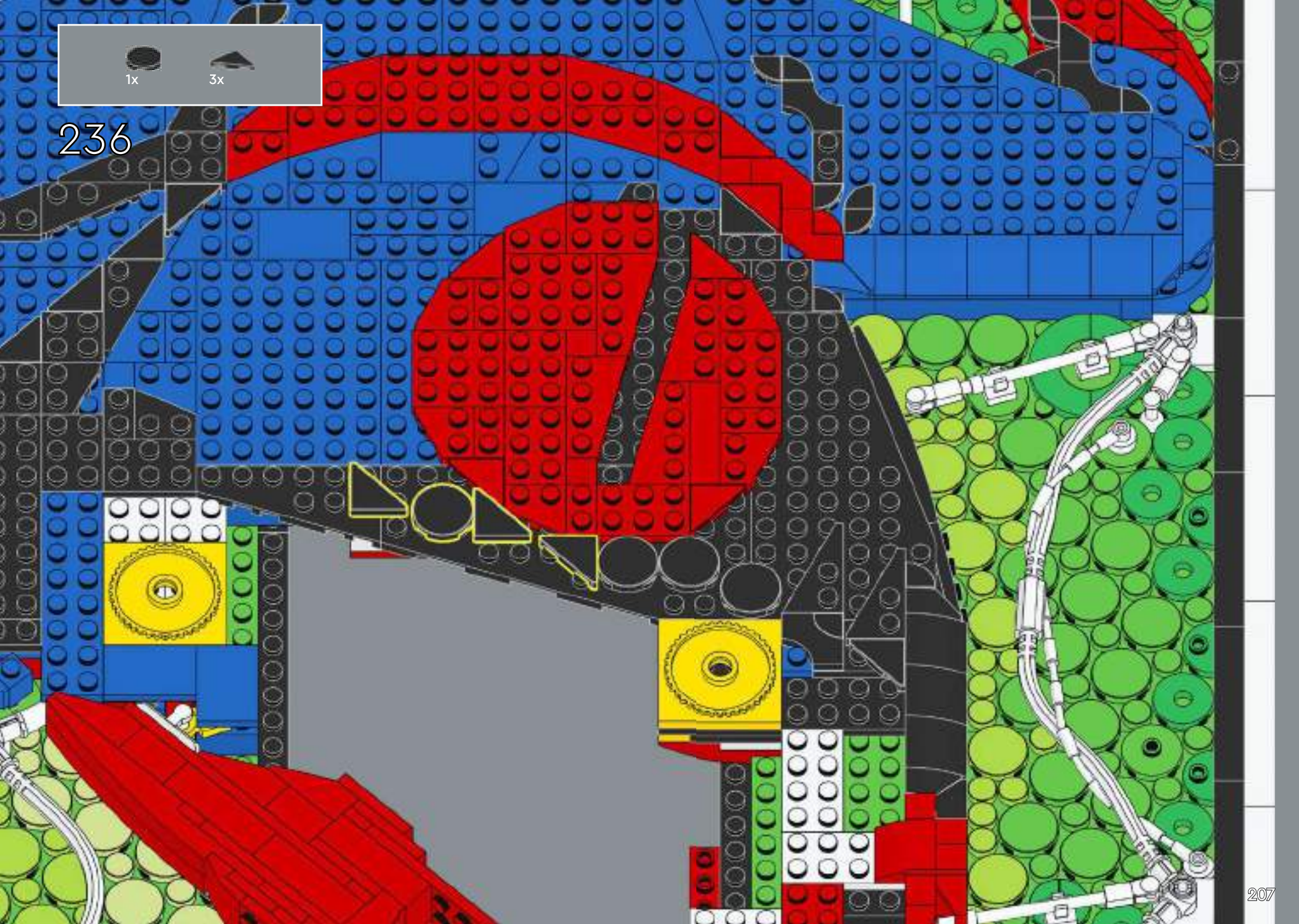

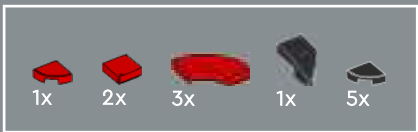

237

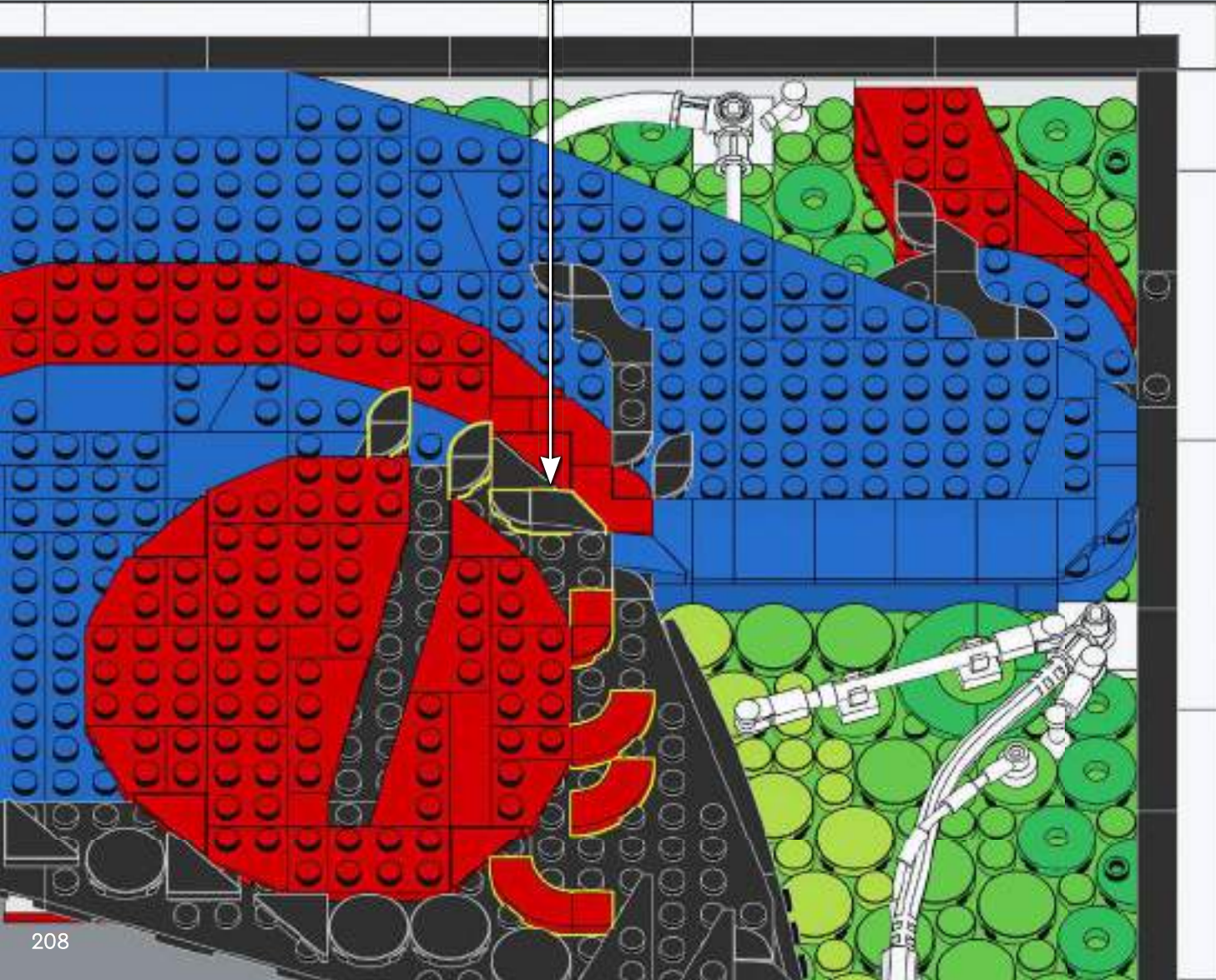

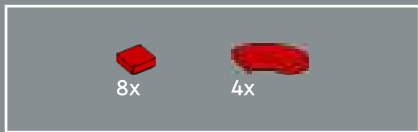

238

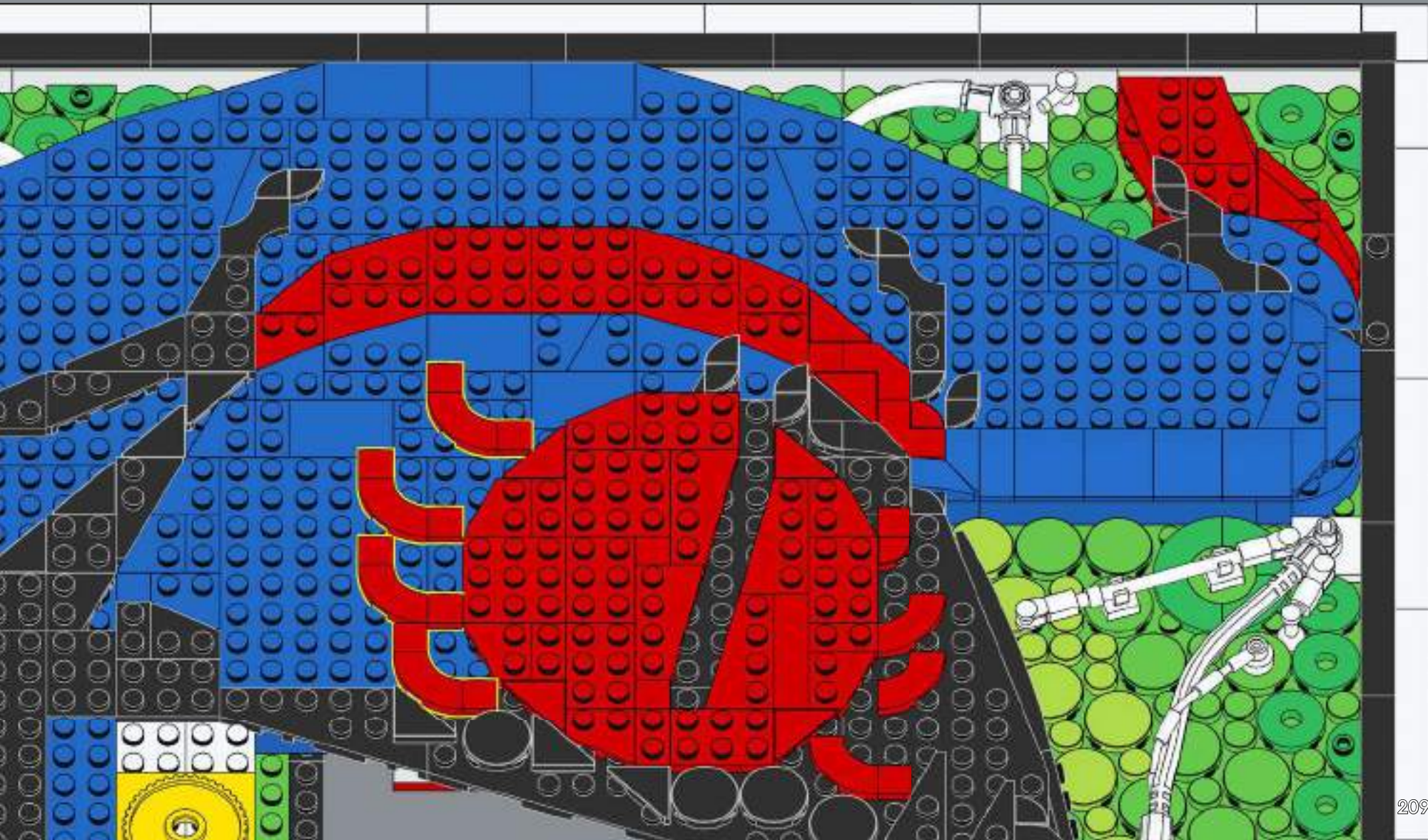

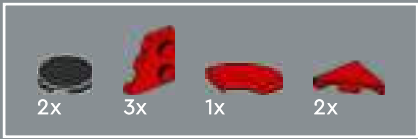

239

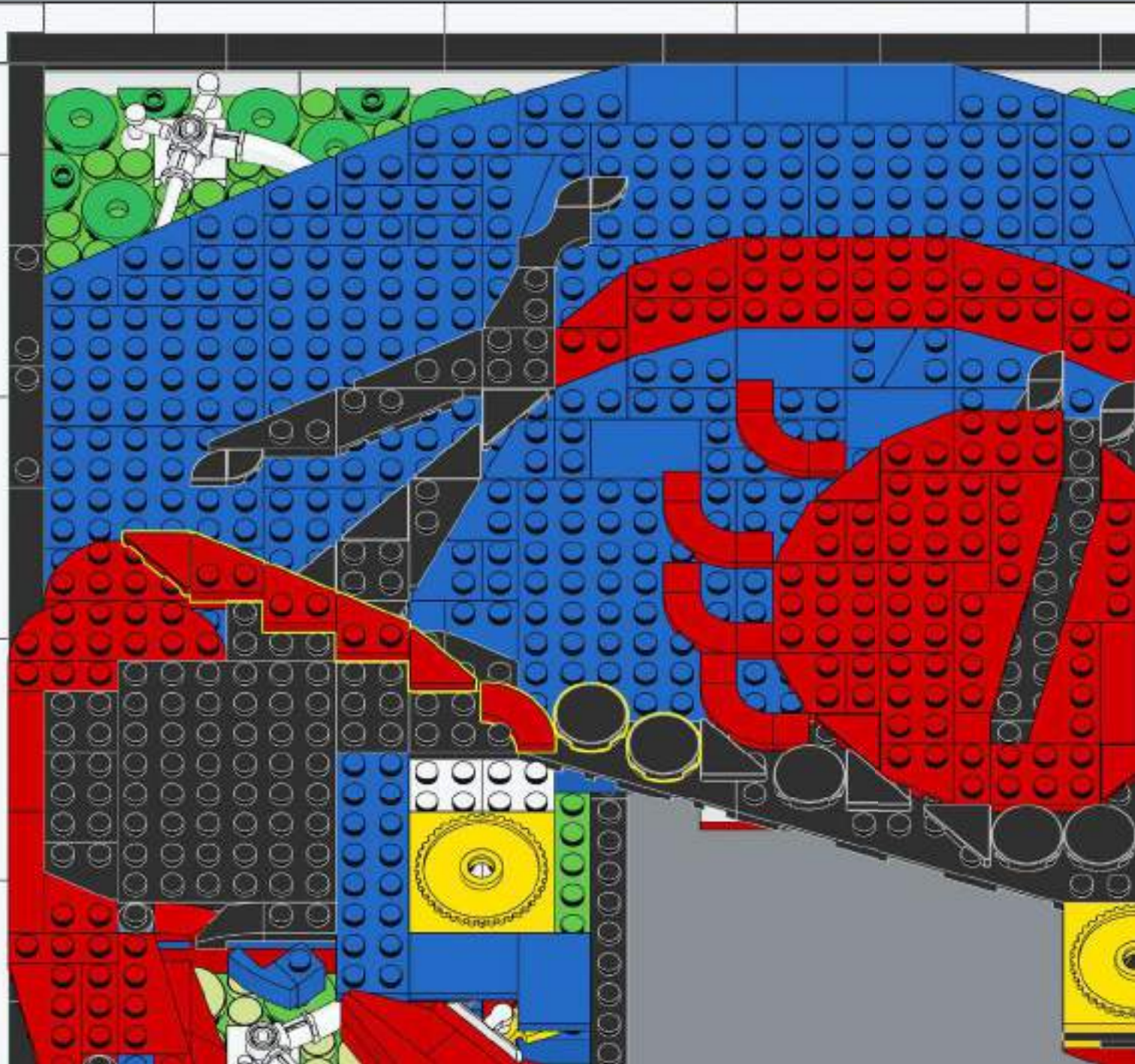

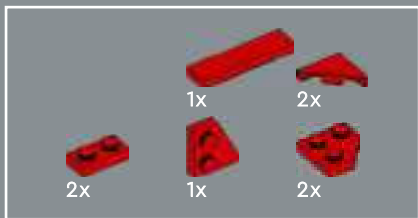

240

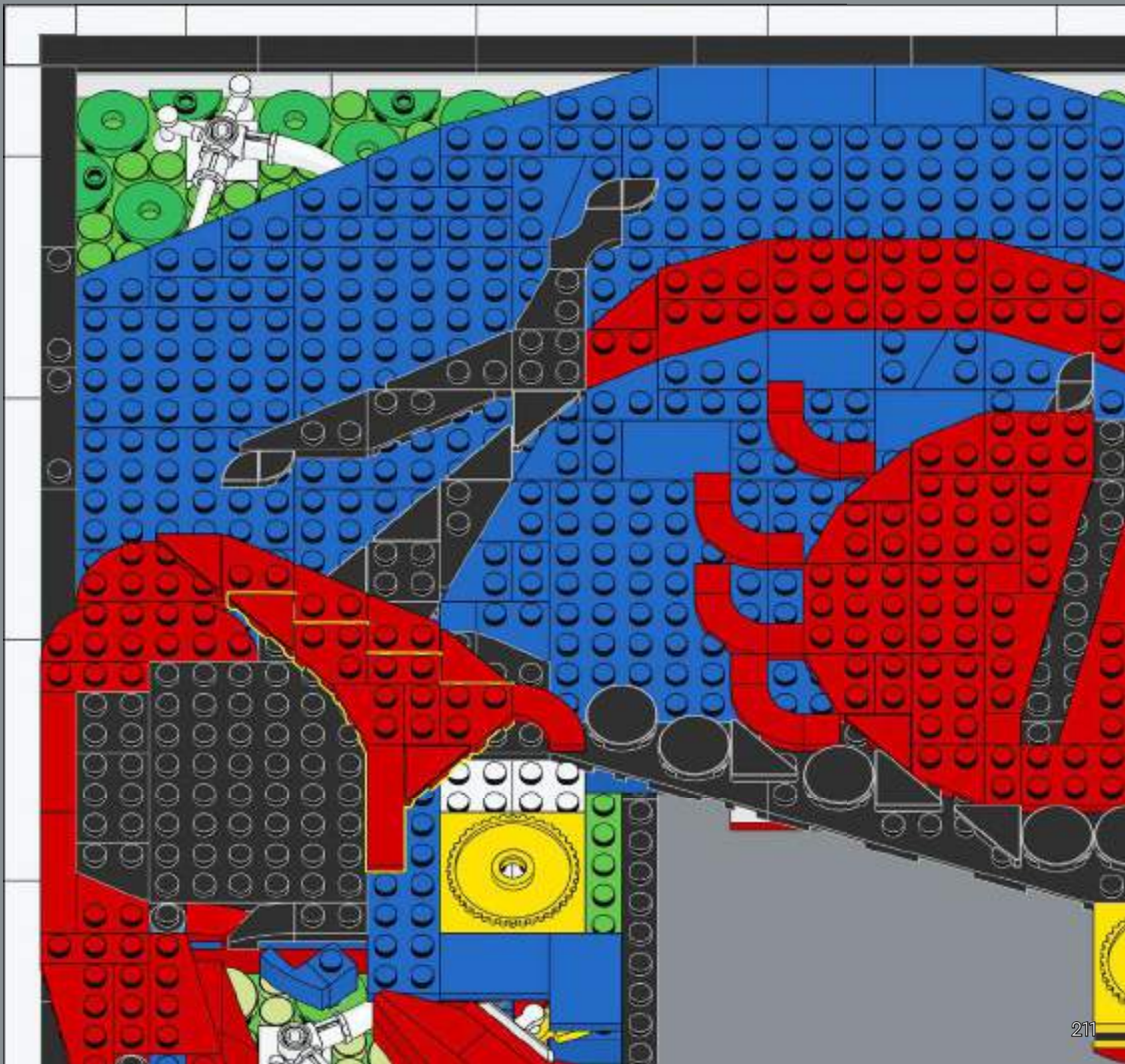



241



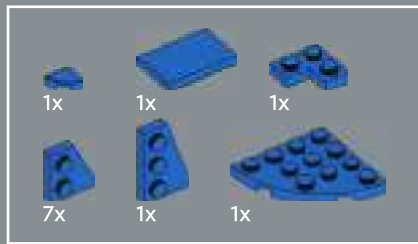

242



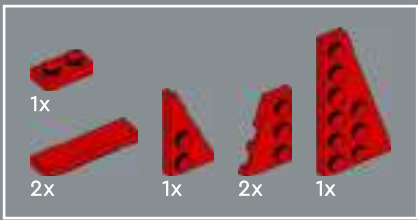

243



8x

244



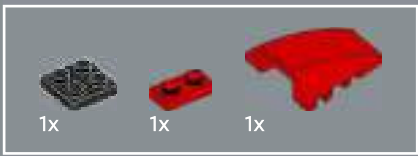

245

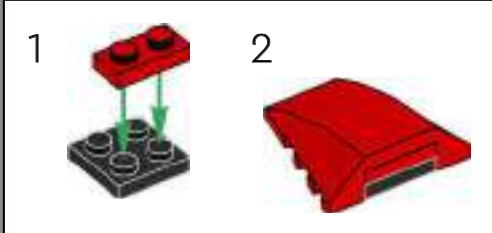



247

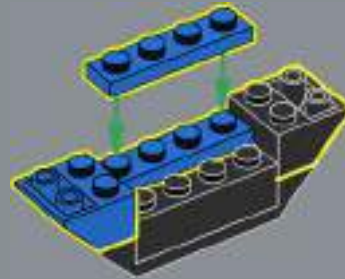

248

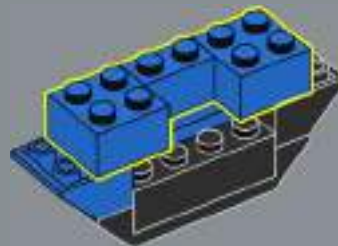

249

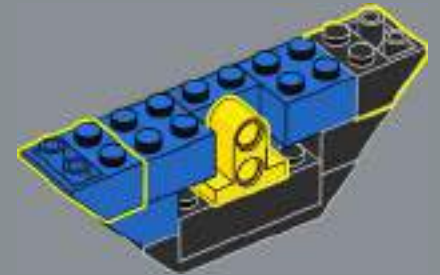

250

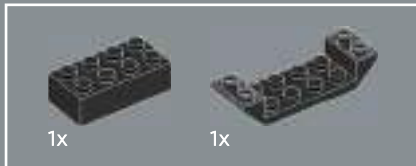
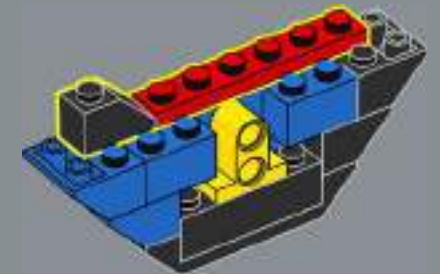

246

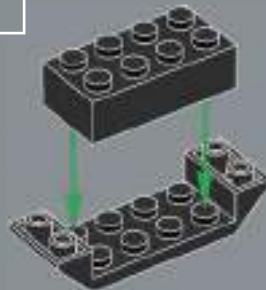

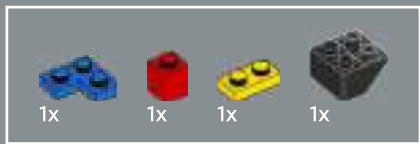

251

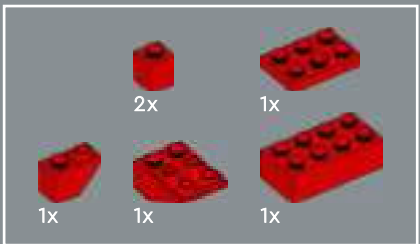
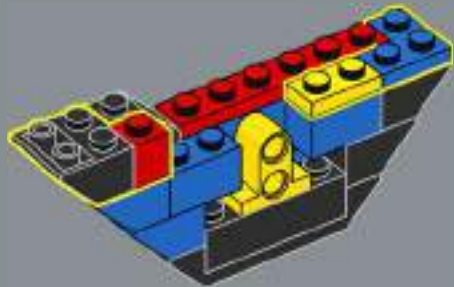

252

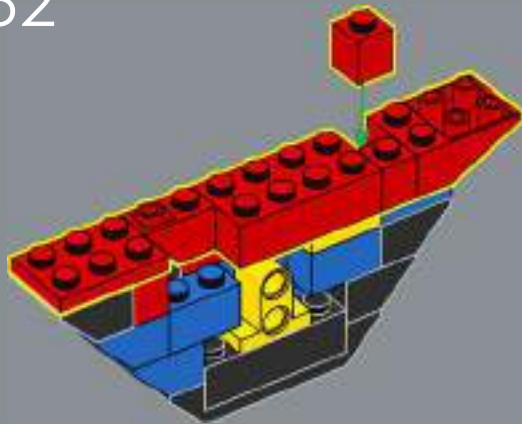

253

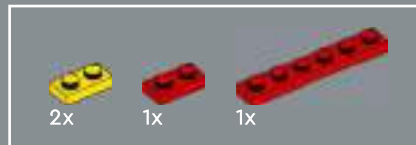
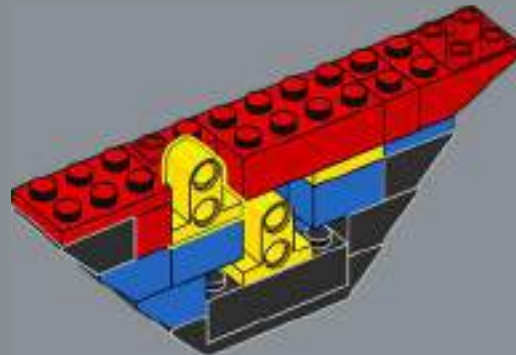

254

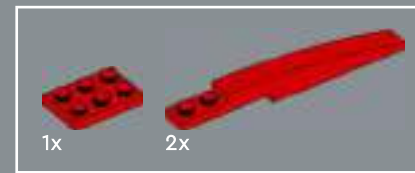
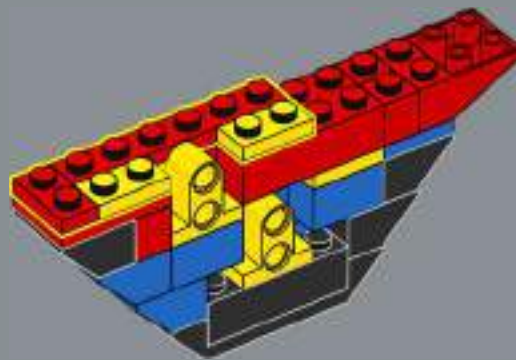

255

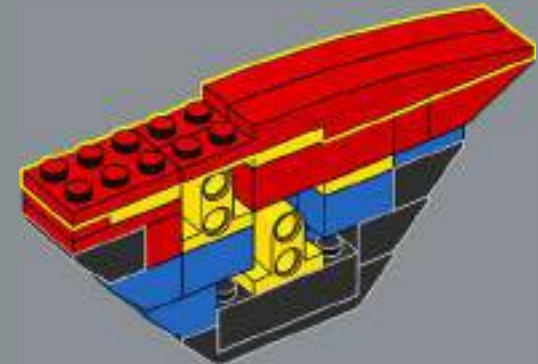

256

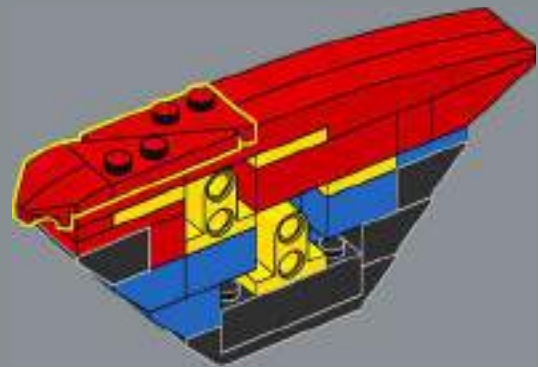

257

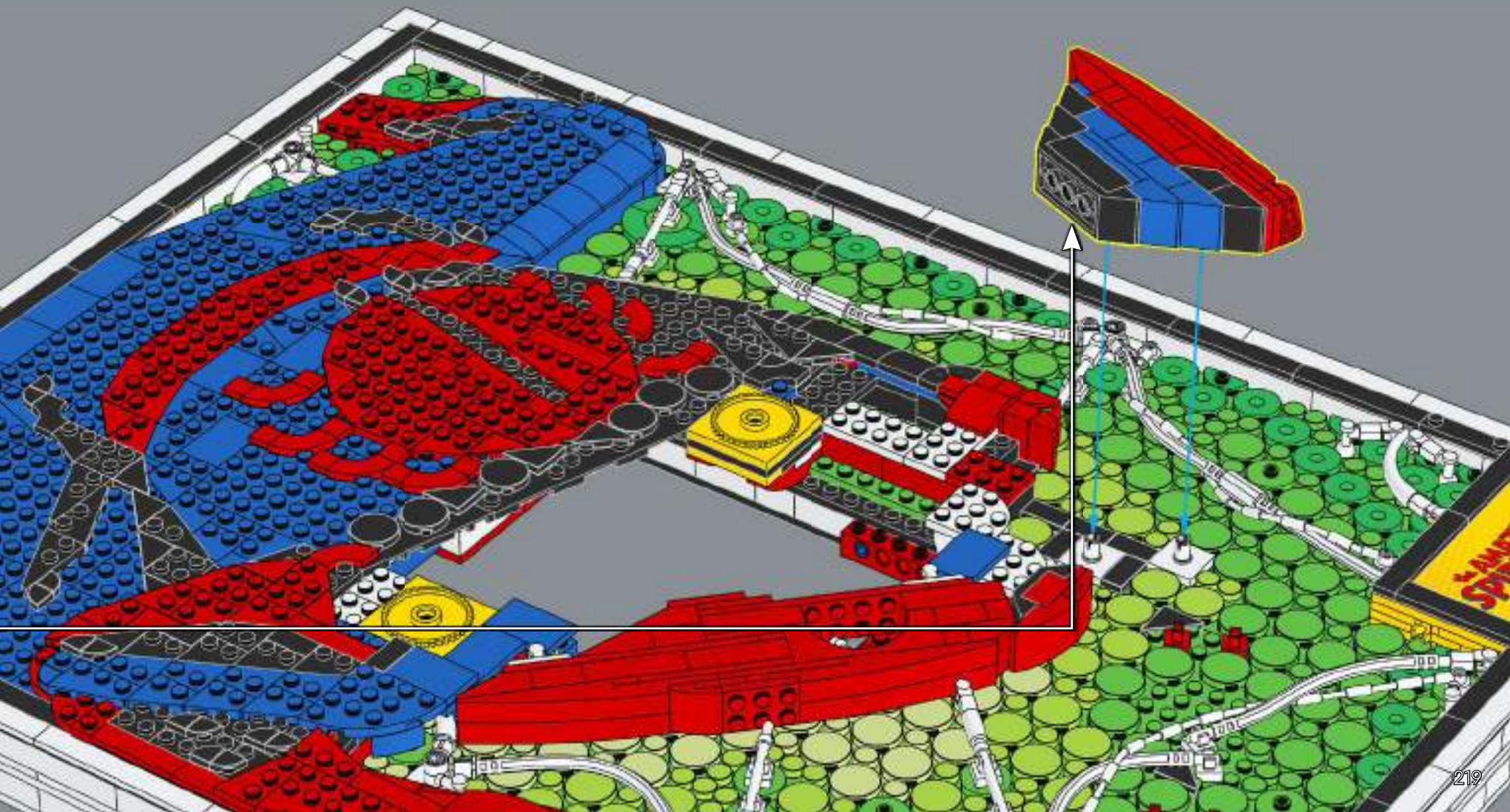
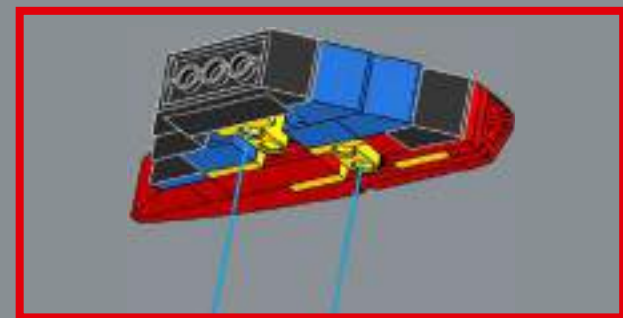



258

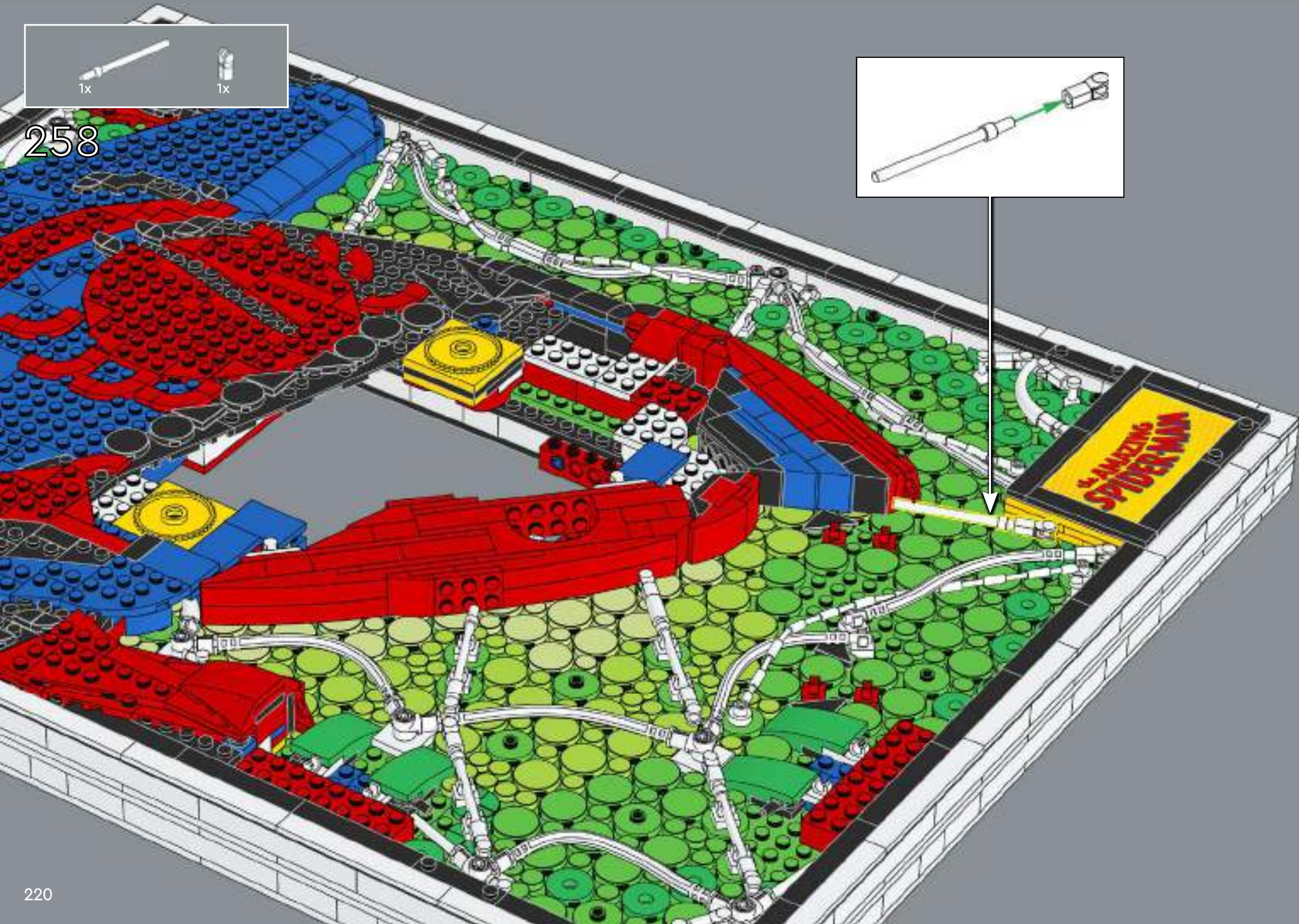
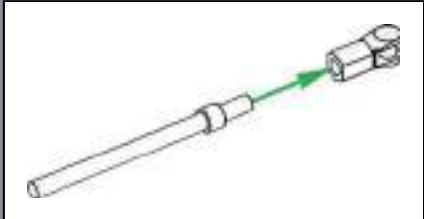

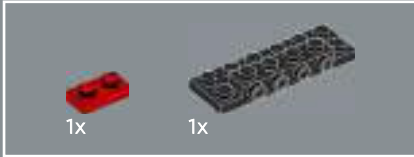

259

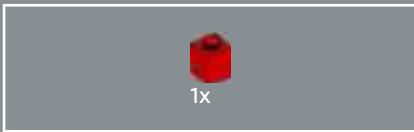

260

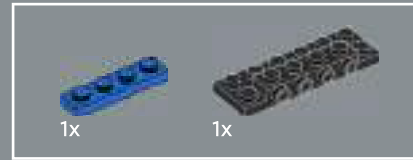

261

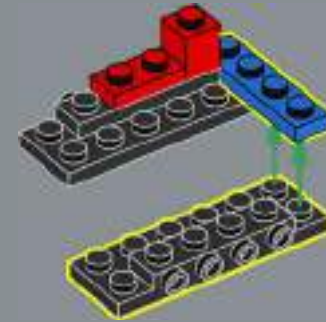

262

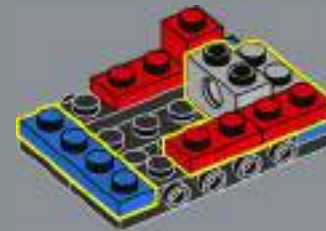

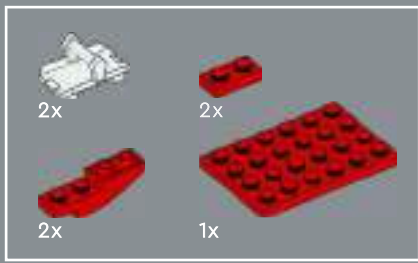

263

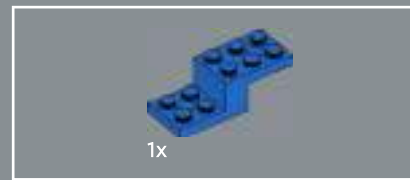
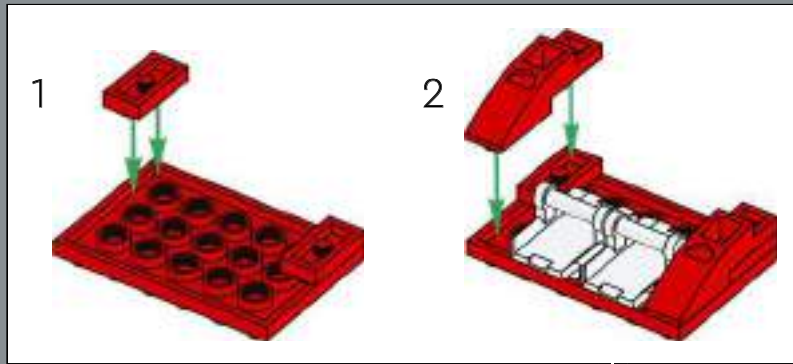

264

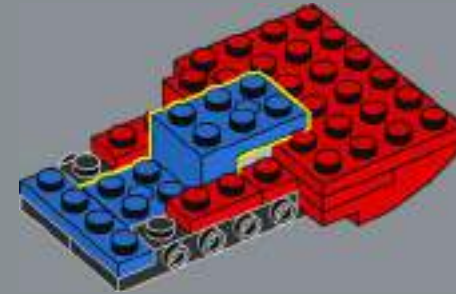

265





266

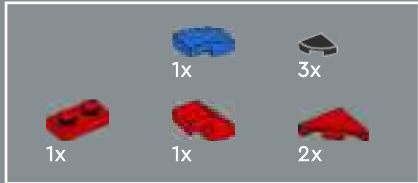
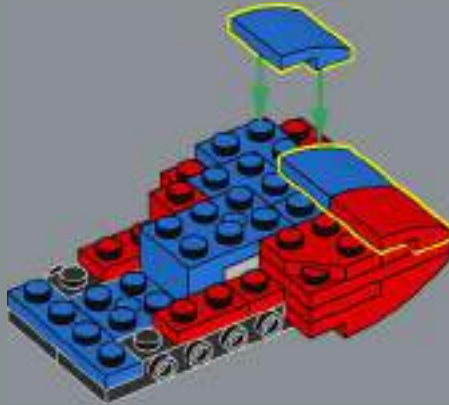

267

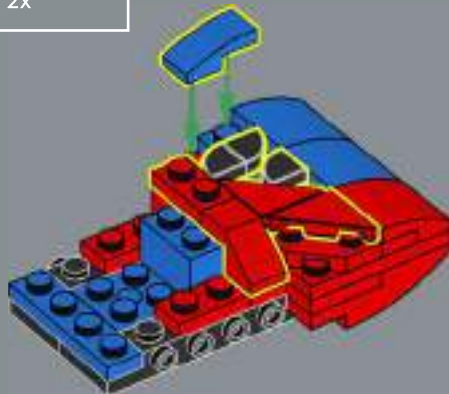

268

Did you know? Spider-Man wears web-shooters on his wrists beneath his costume - they can shoot thin strands of the special web fluid at high pressure.

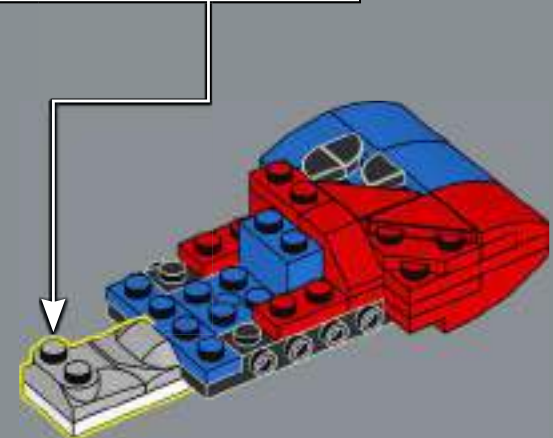
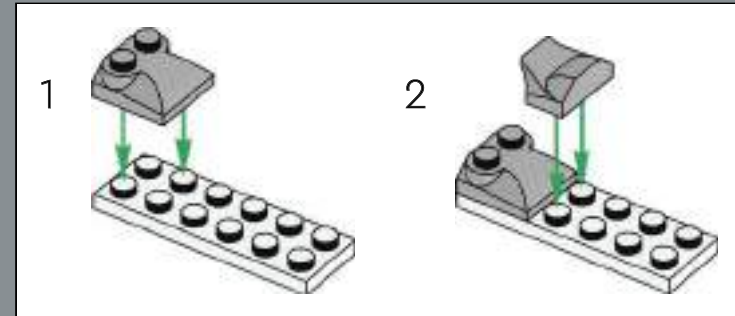

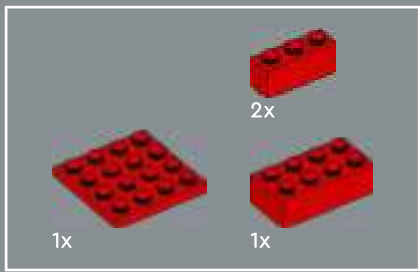

269

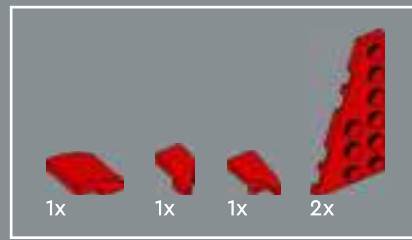
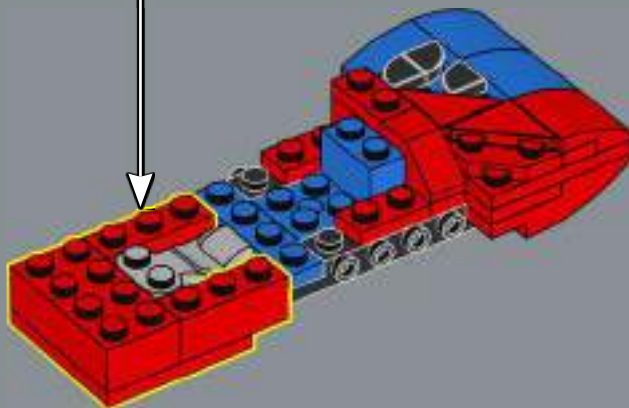
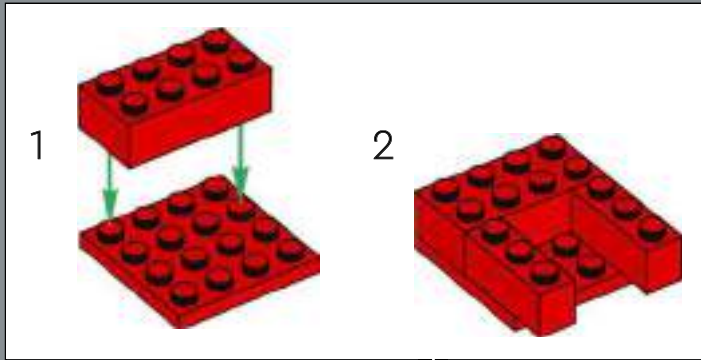

270

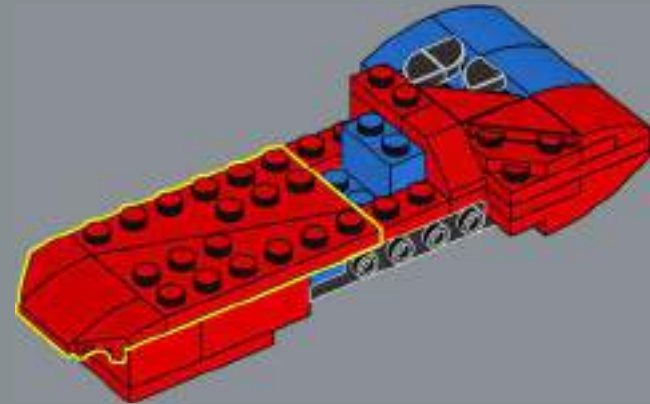

271

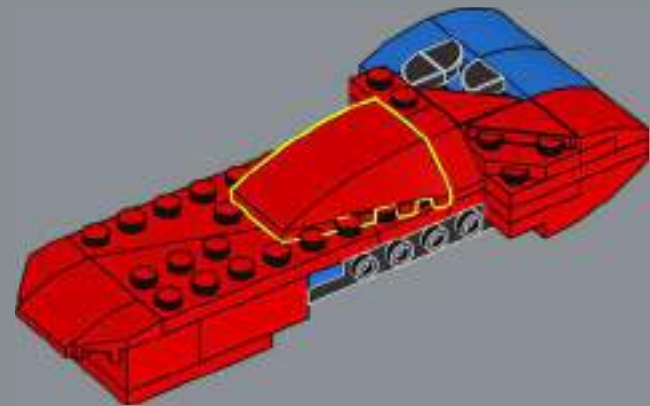

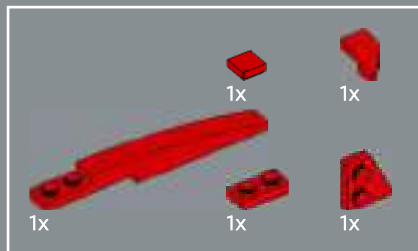

272

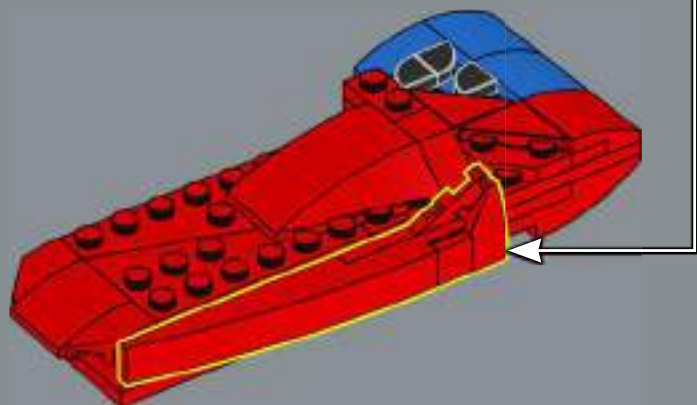
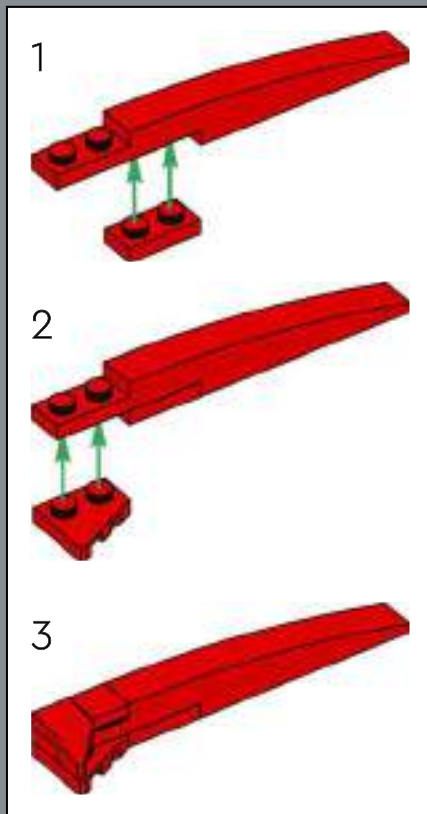

273

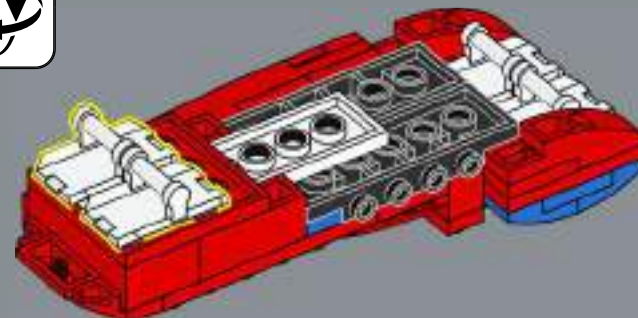

Pythagorean theorem tells us that $A^2 + B^2 = C^2$, meaning that $11^2 + 2^2 = C^2$ and $C = \sqrt{125}$



274

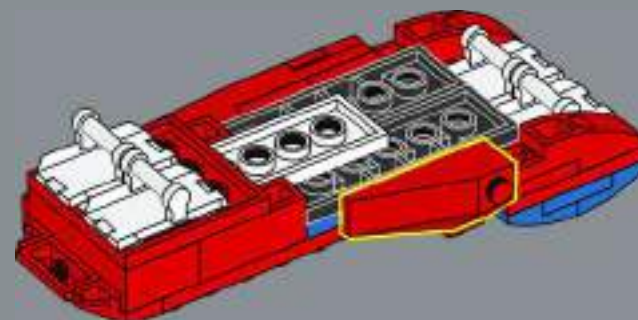



The red clip distances from Bag 5 and the lengths of the bar connectors are the same - These triangles fit thanks to the magic of an elusive **Pythagorean Pair**! Mysterio would be proud!

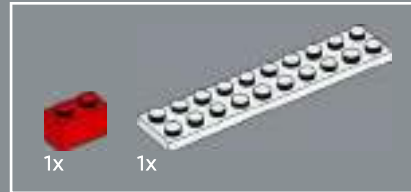
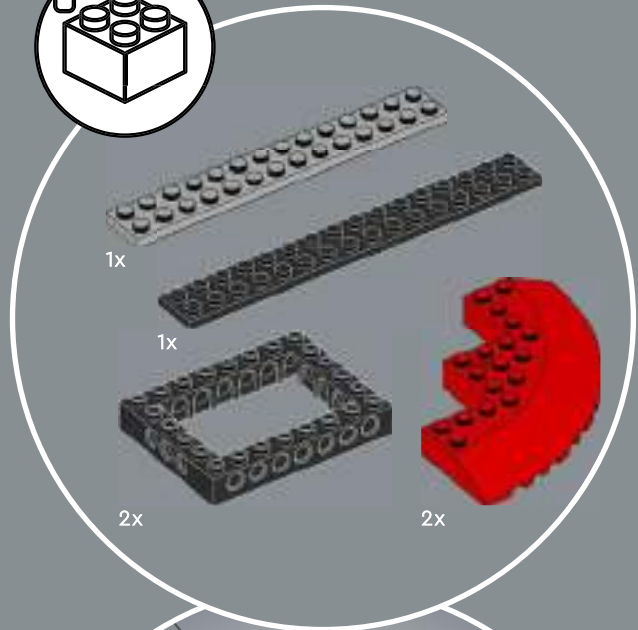
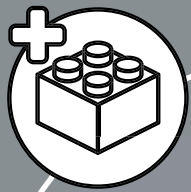

276

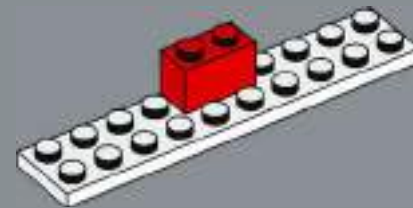

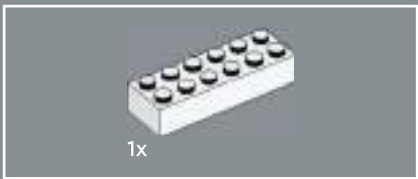

277

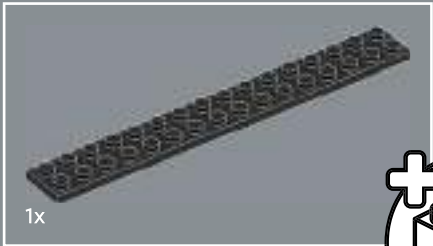
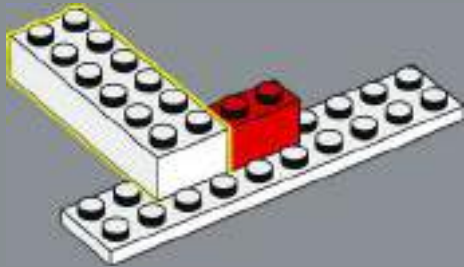

278

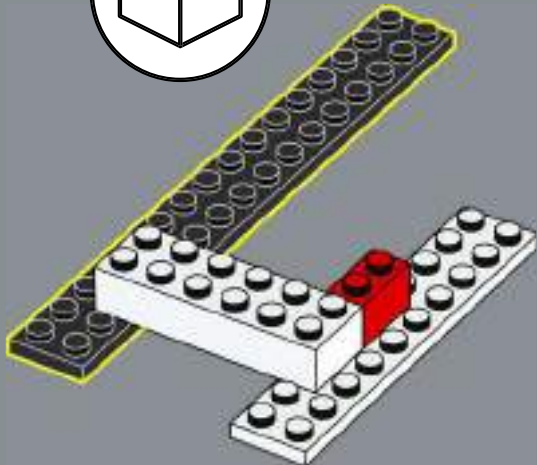
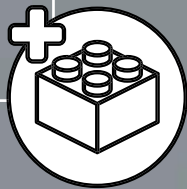

279

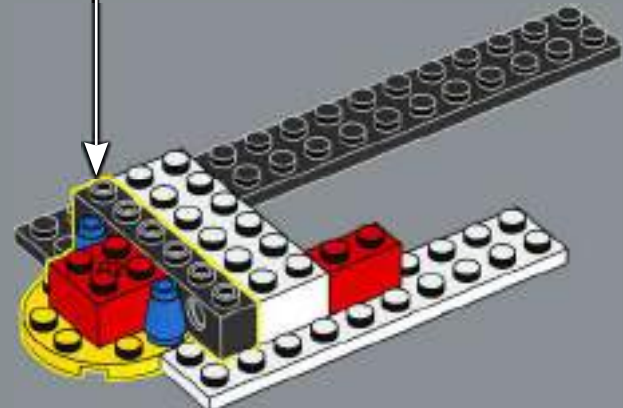
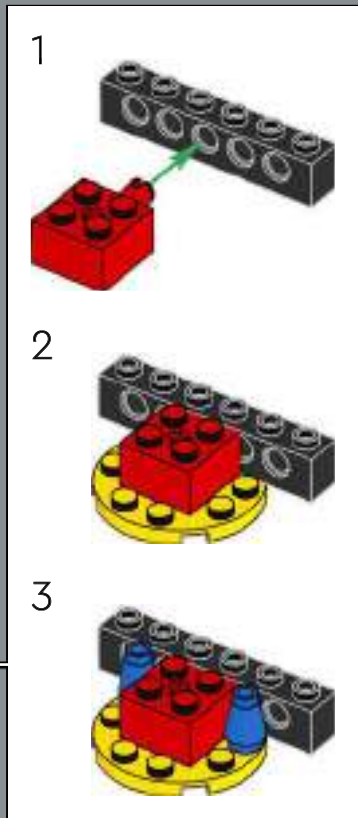



280

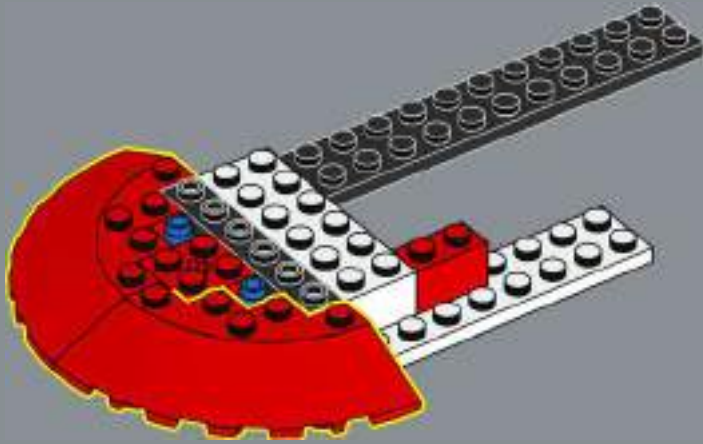

281

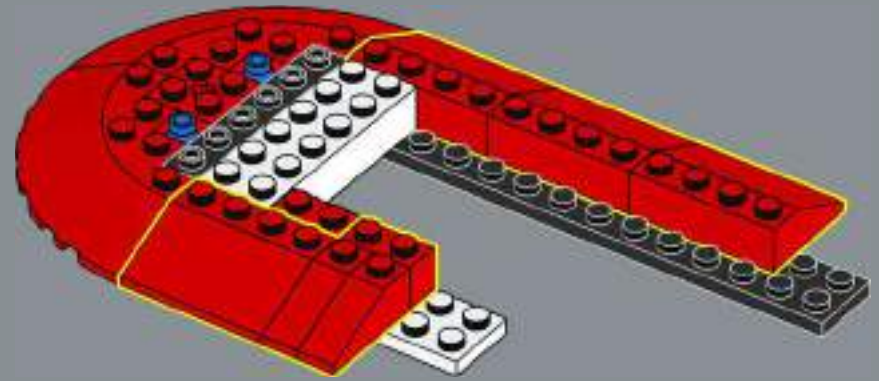

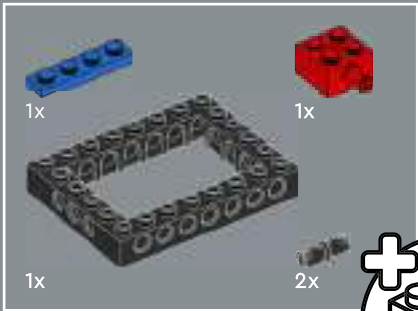

282

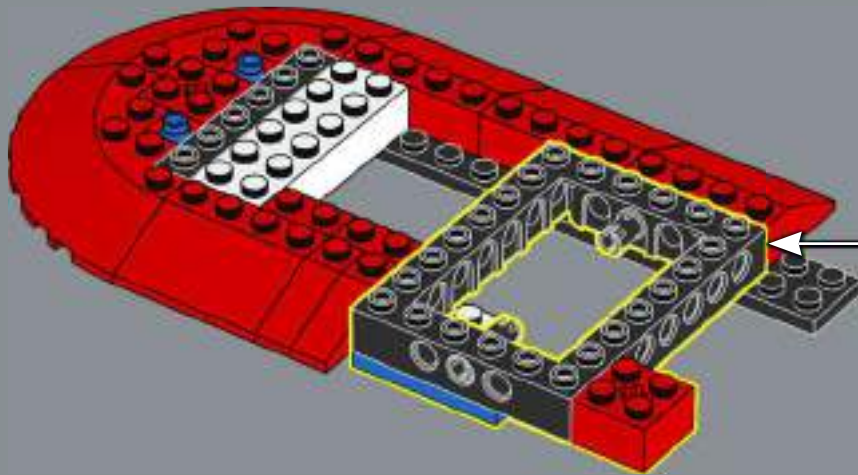
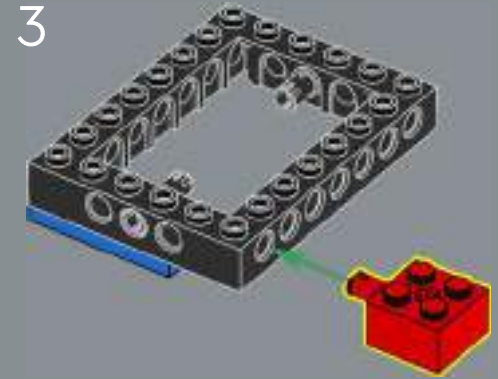
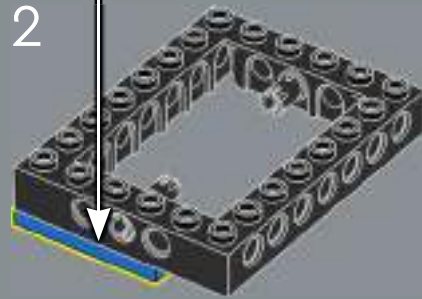
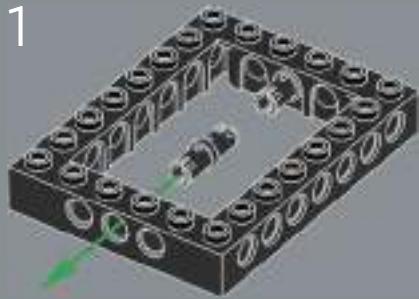
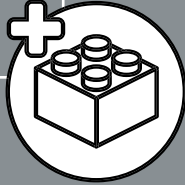

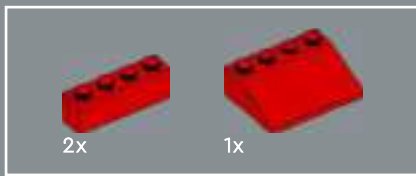

283

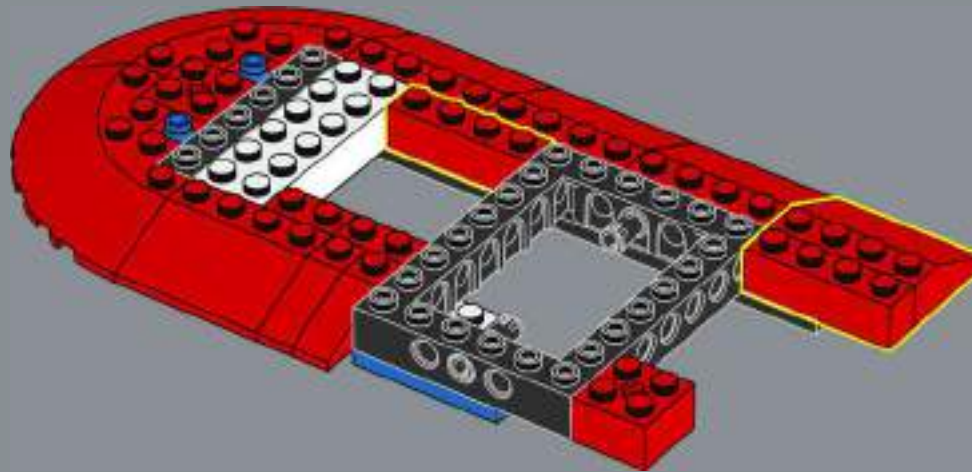

284

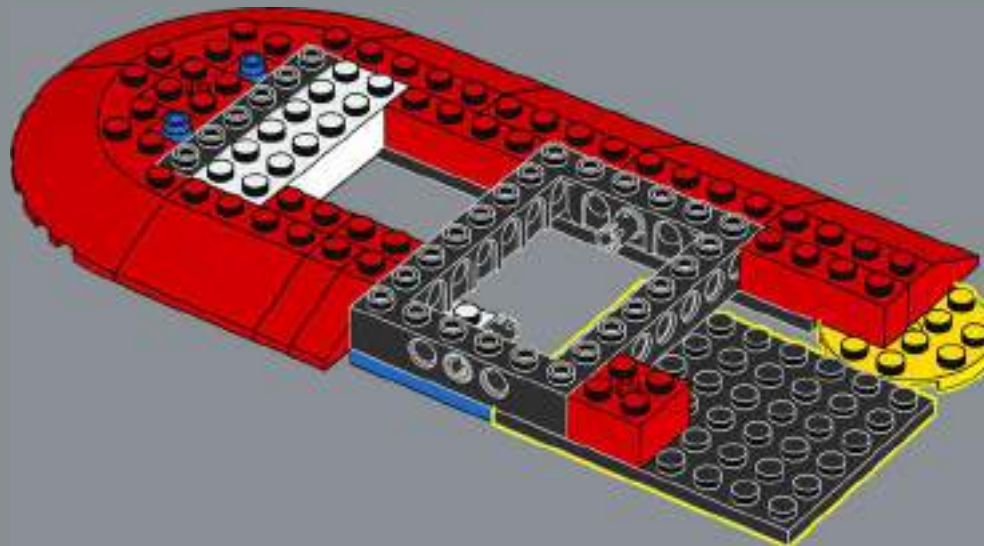

The yellow 4x4 round plates are also placed precisely **18 across** and **3 down** ... Correct guesses as to the purpose might be awarded a prestigious No-Prize.

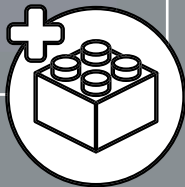
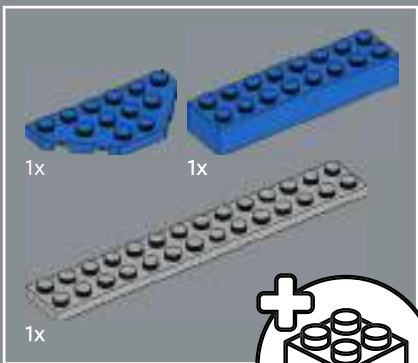

285

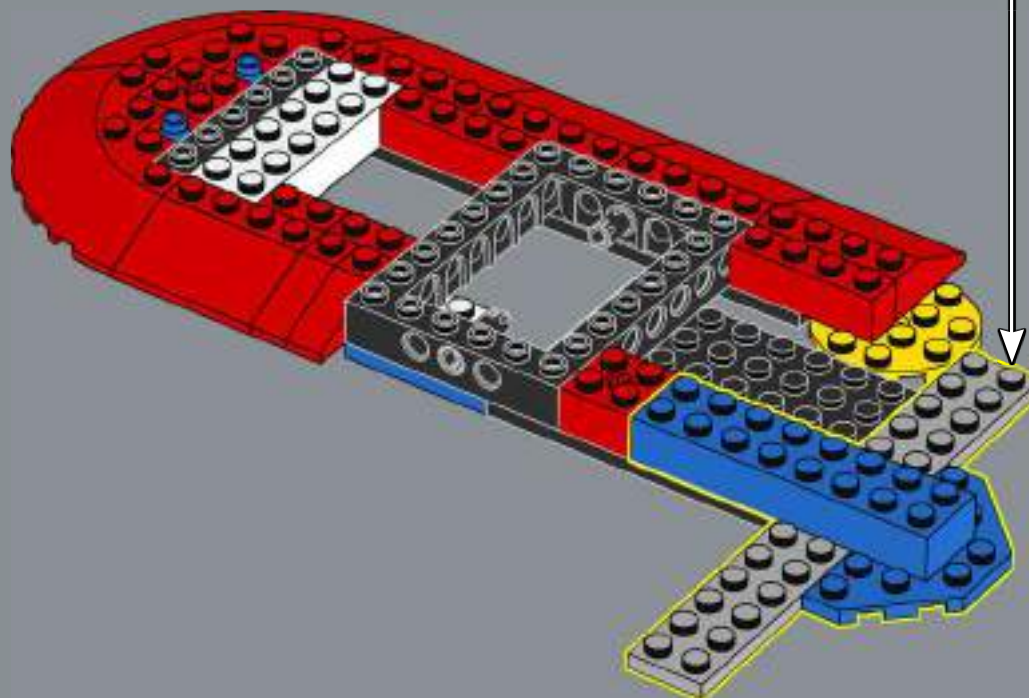
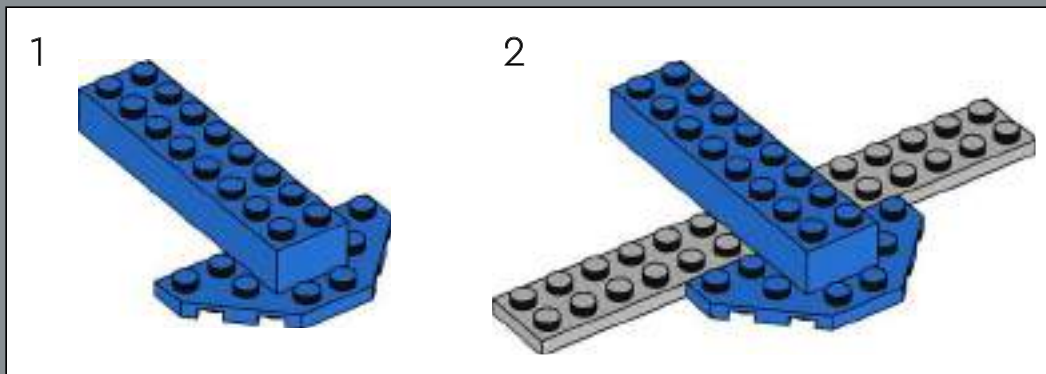

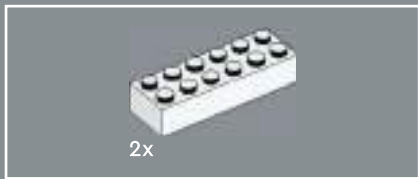

286

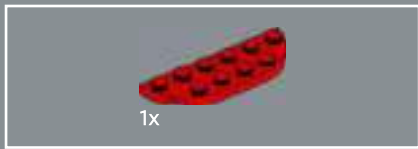
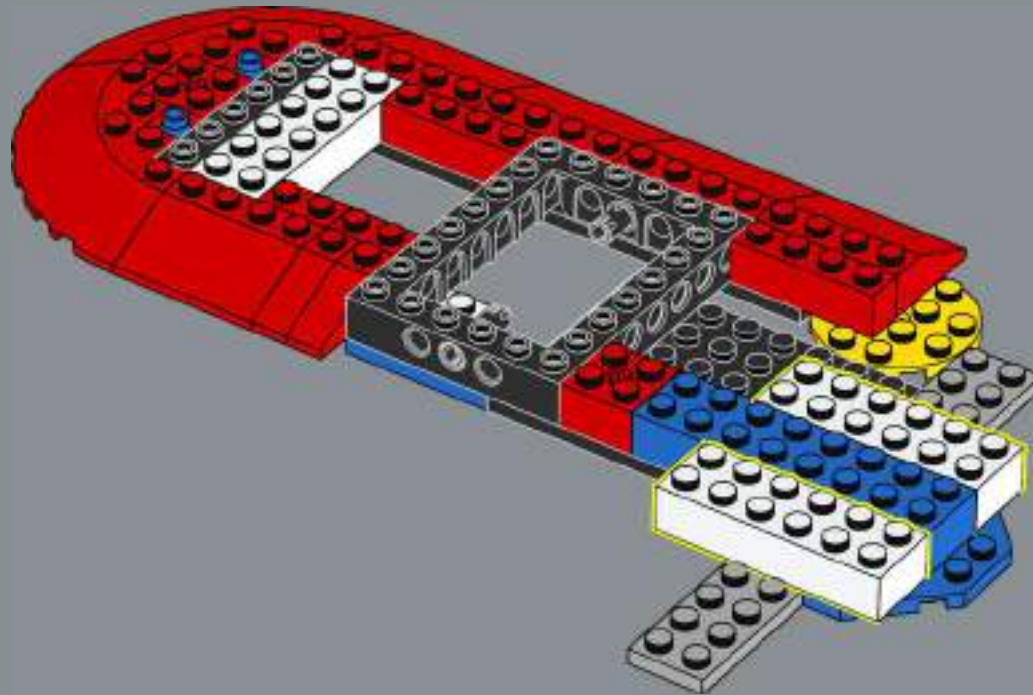

287

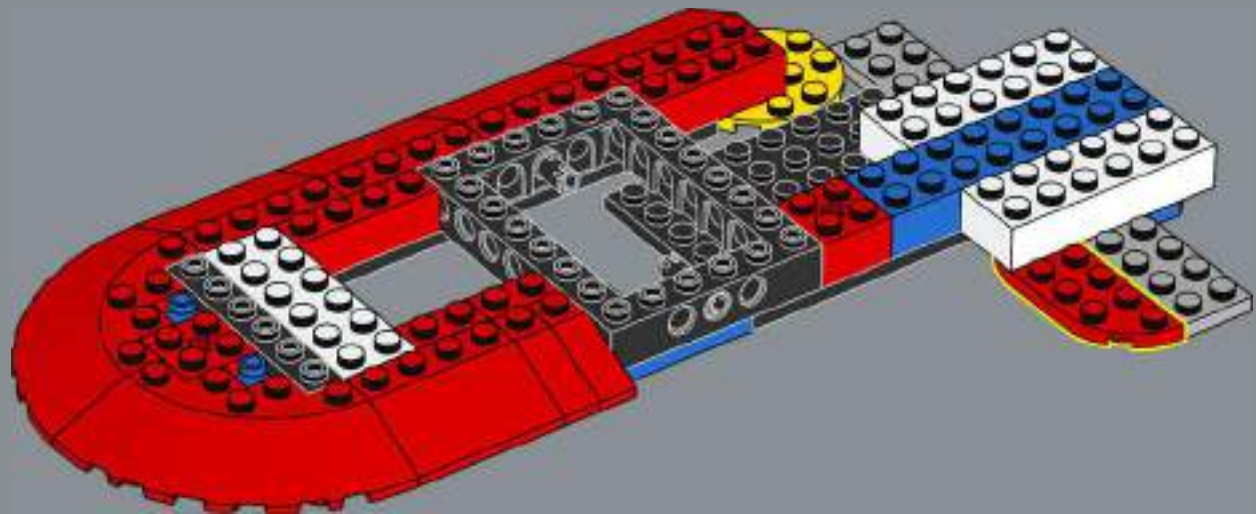

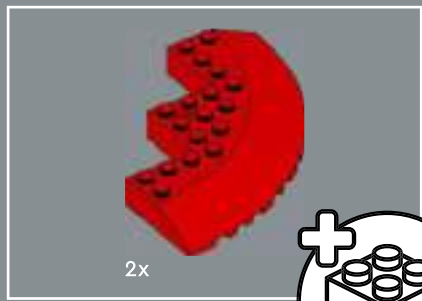

2x

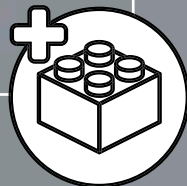

288

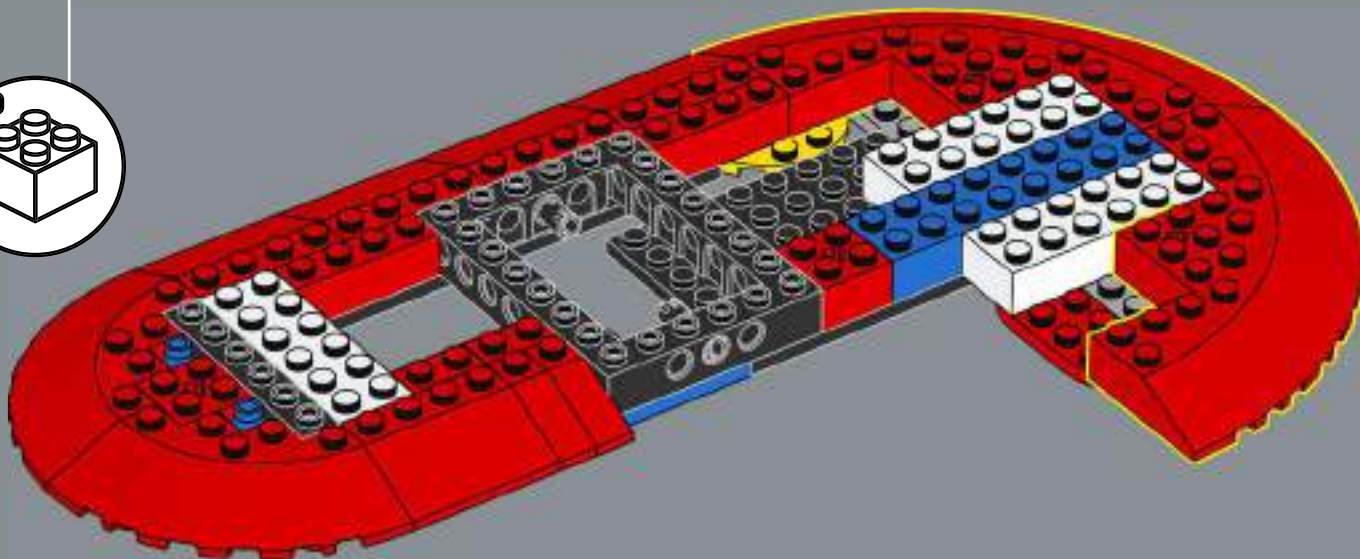

3x

3x

289

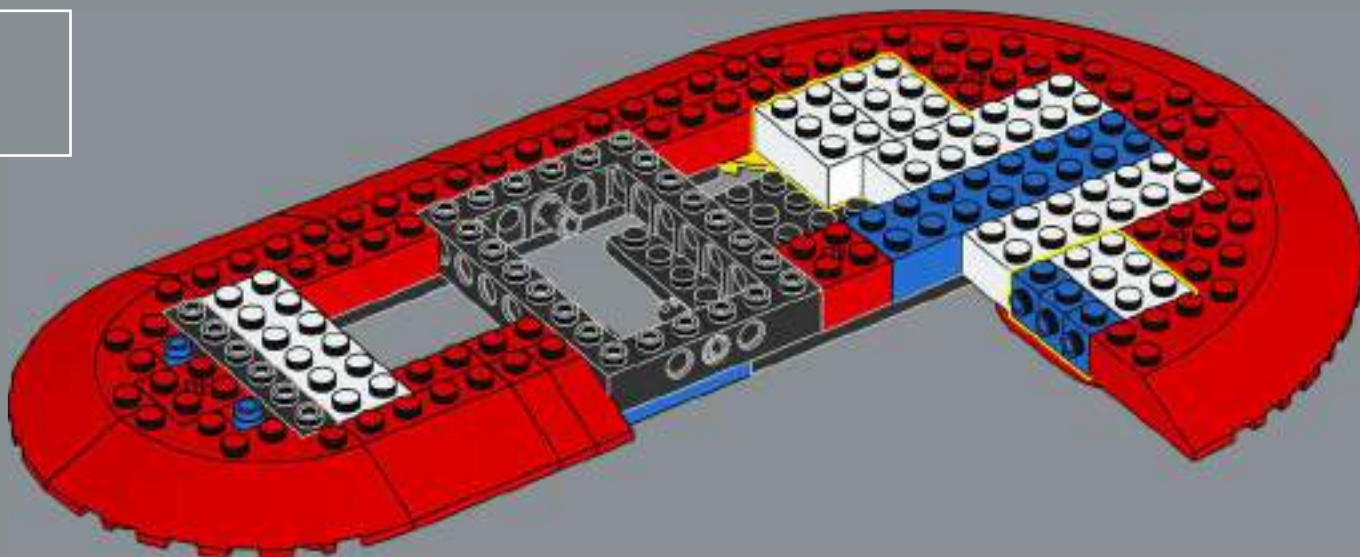



290

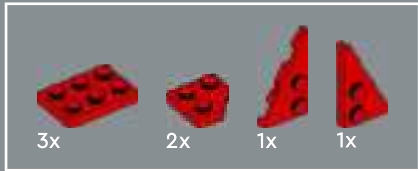
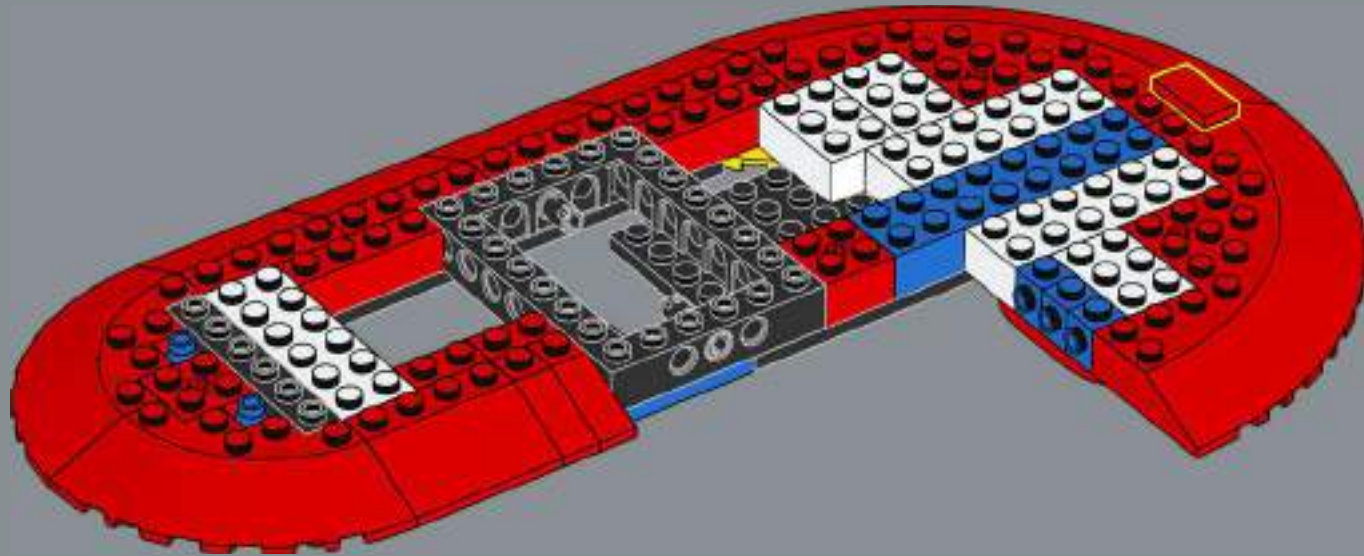

291

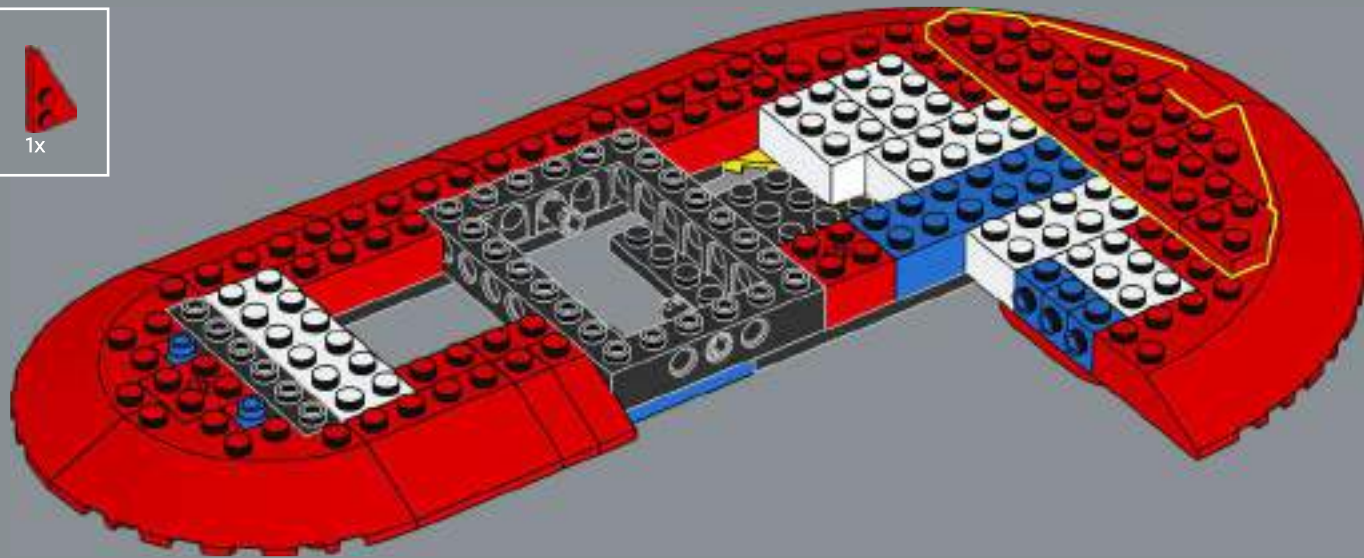

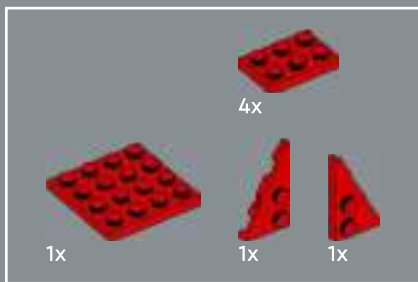

292

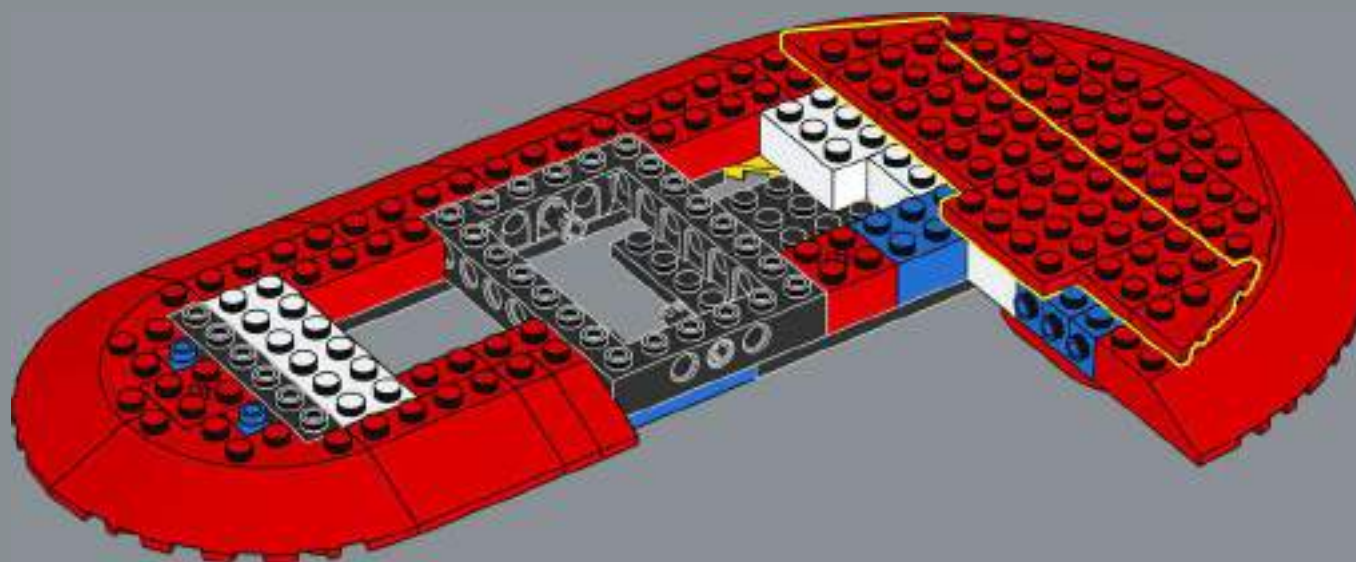



293

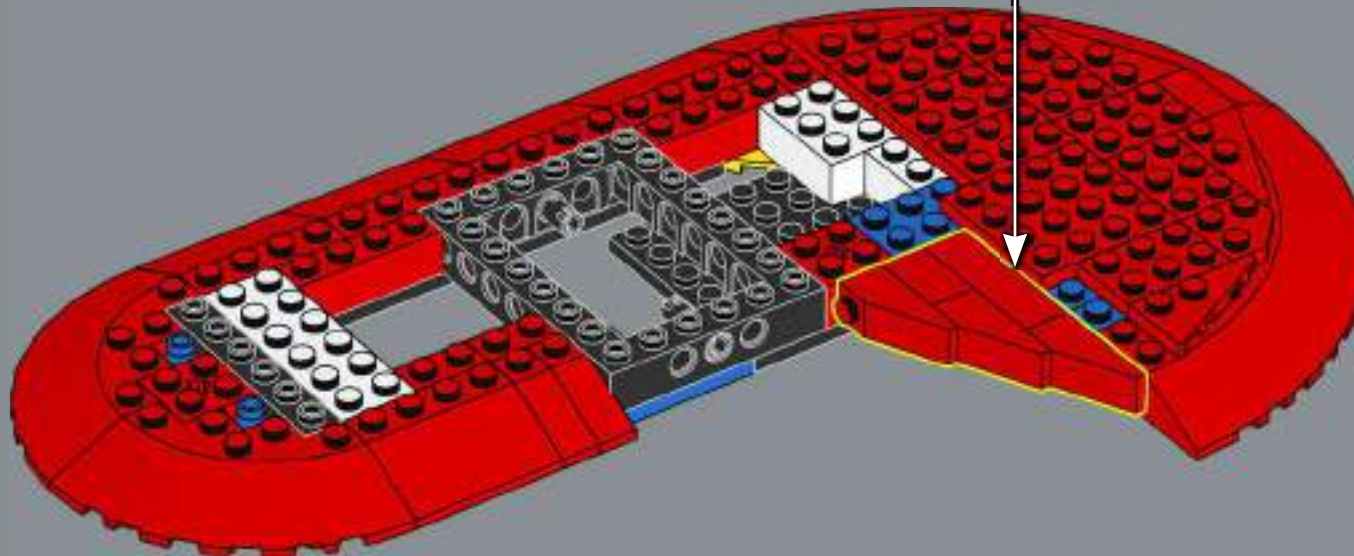
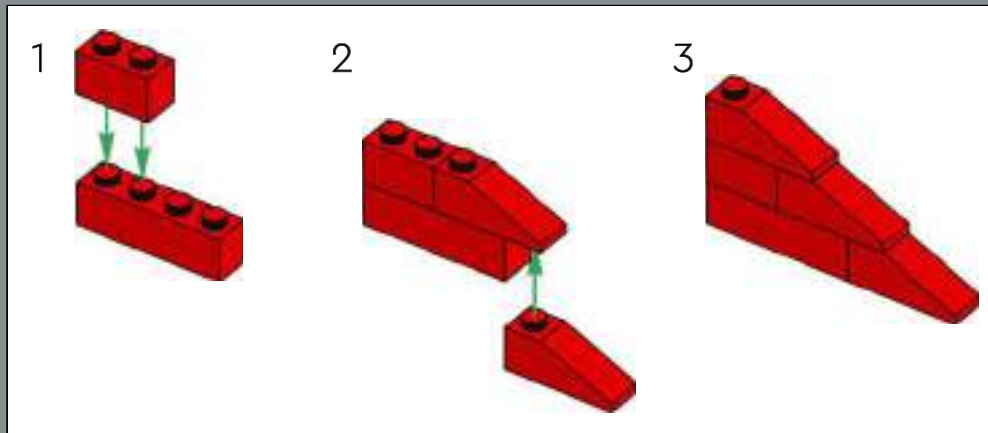

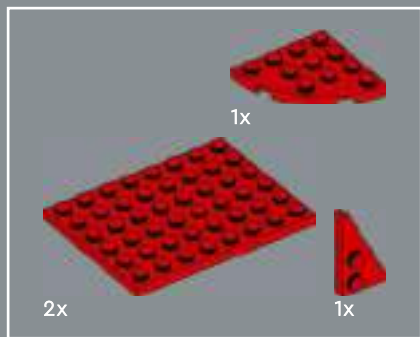

294

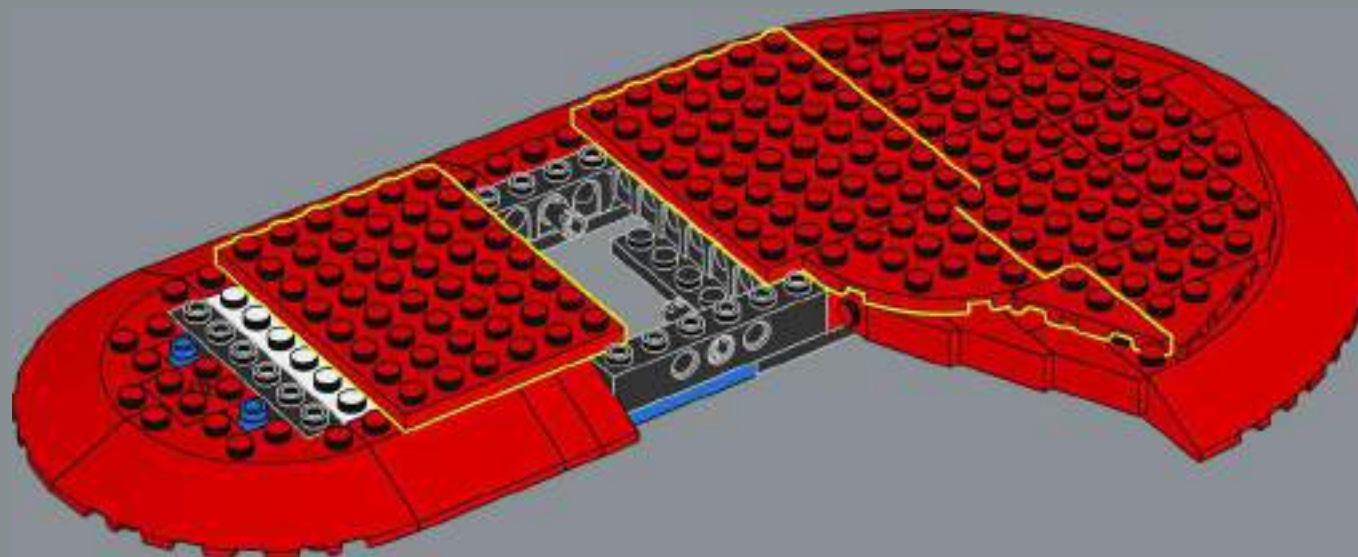

295

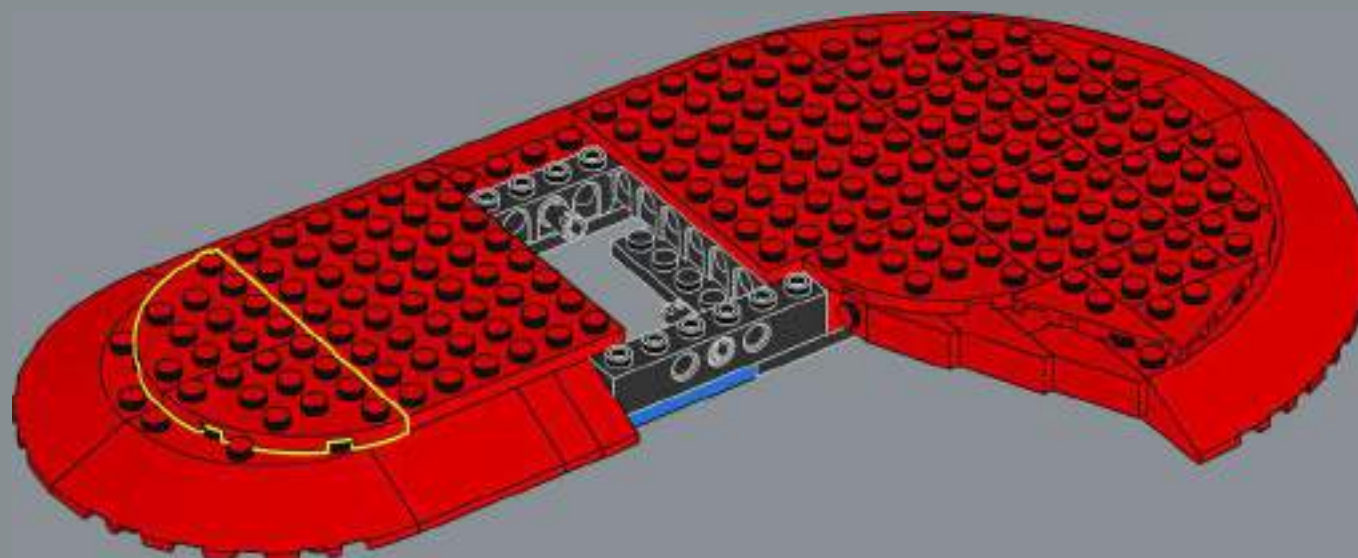

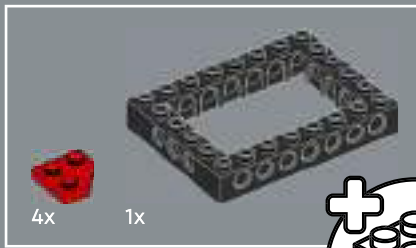

296

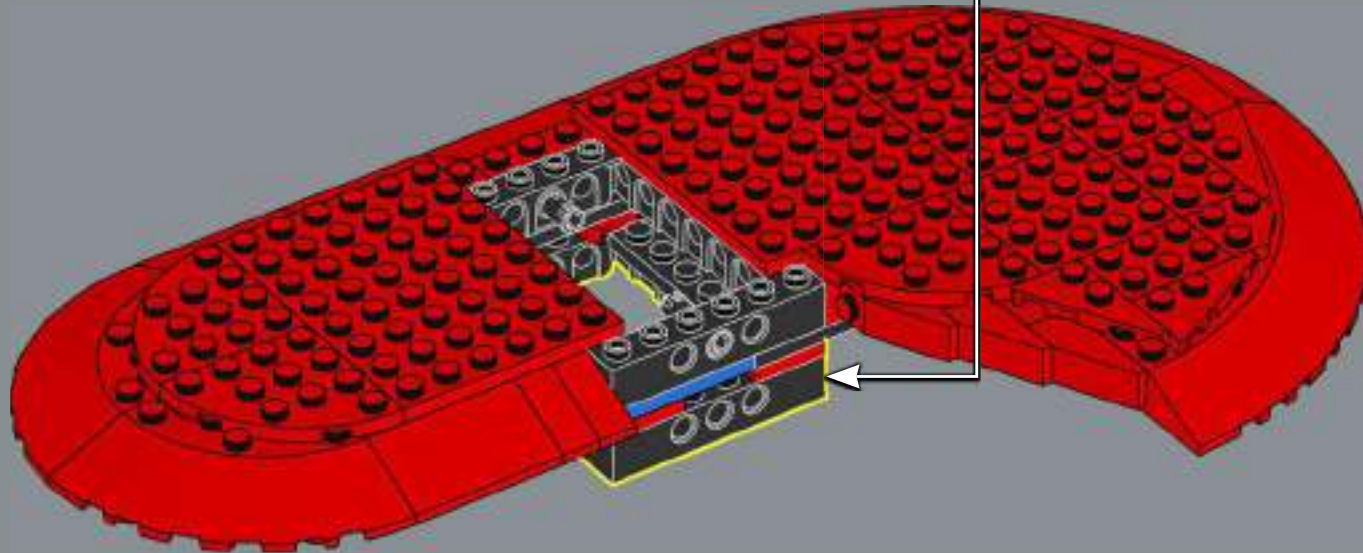
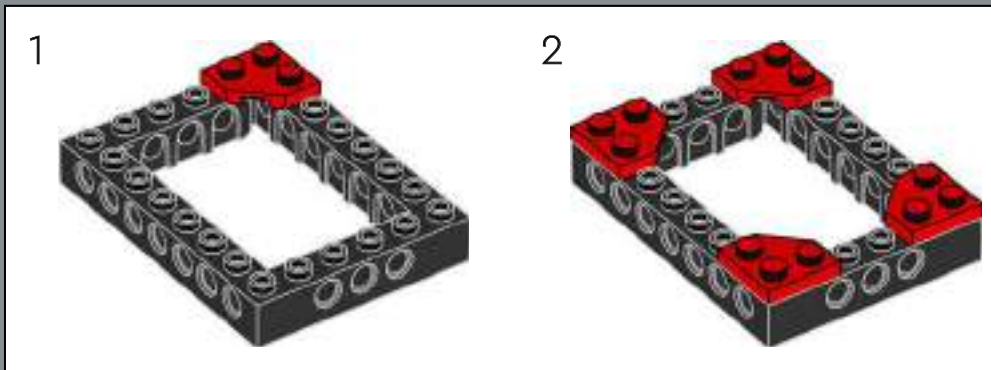
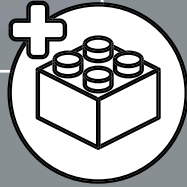



The Marvel No-Prize was pioneered by Stan Lee in the 1960s as a recognition for spotting continuity errors in the comics. Today, the prize is awarded for charitable works and "meritorious service to Marvel above and beyond the call of duty."

297

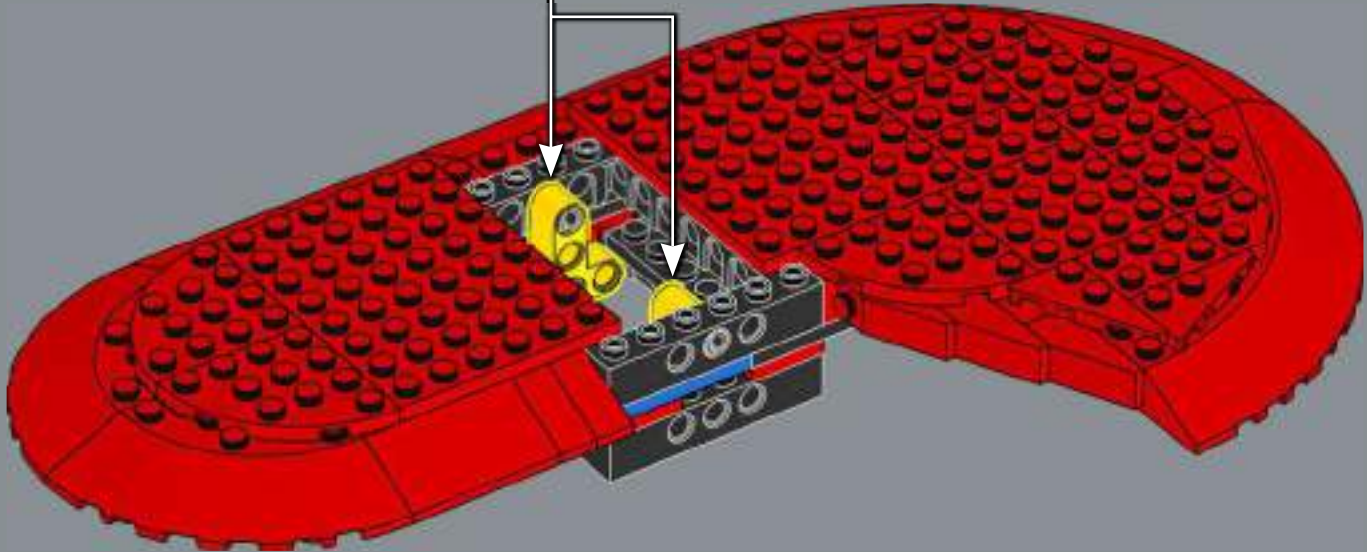

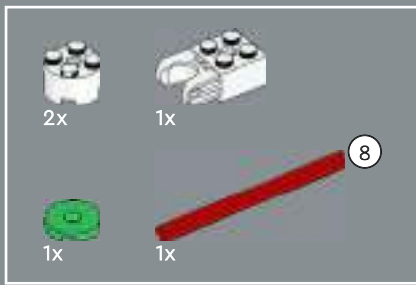

298

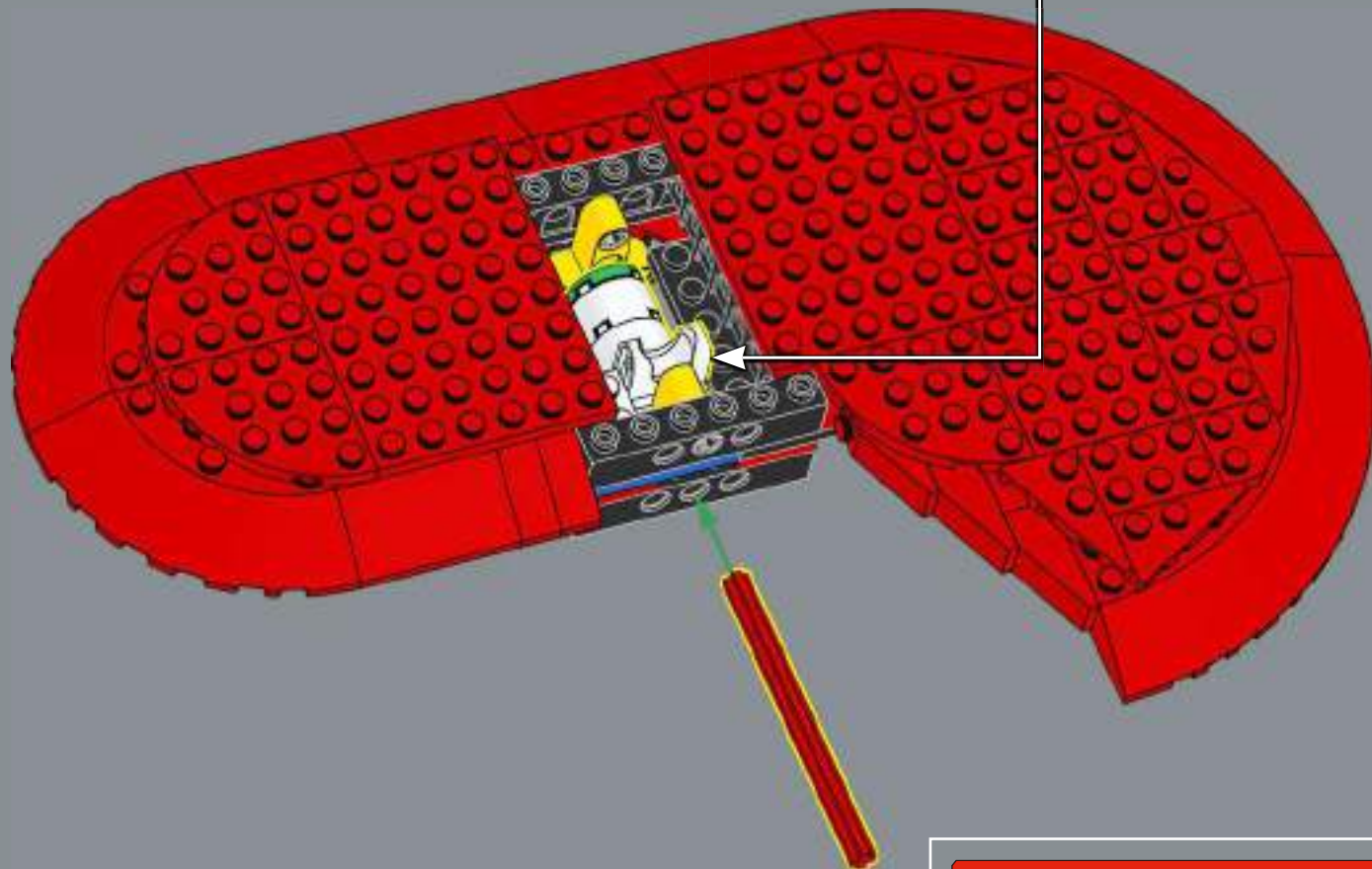
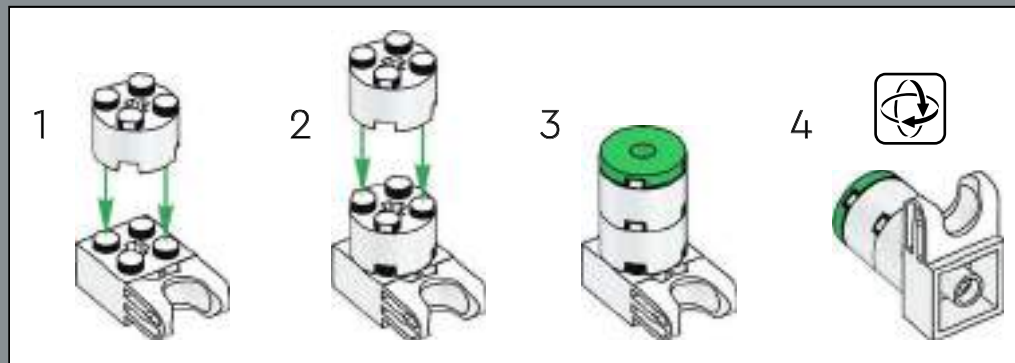

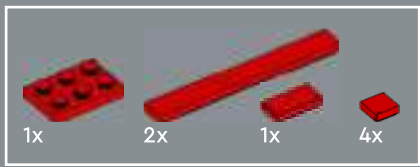

299

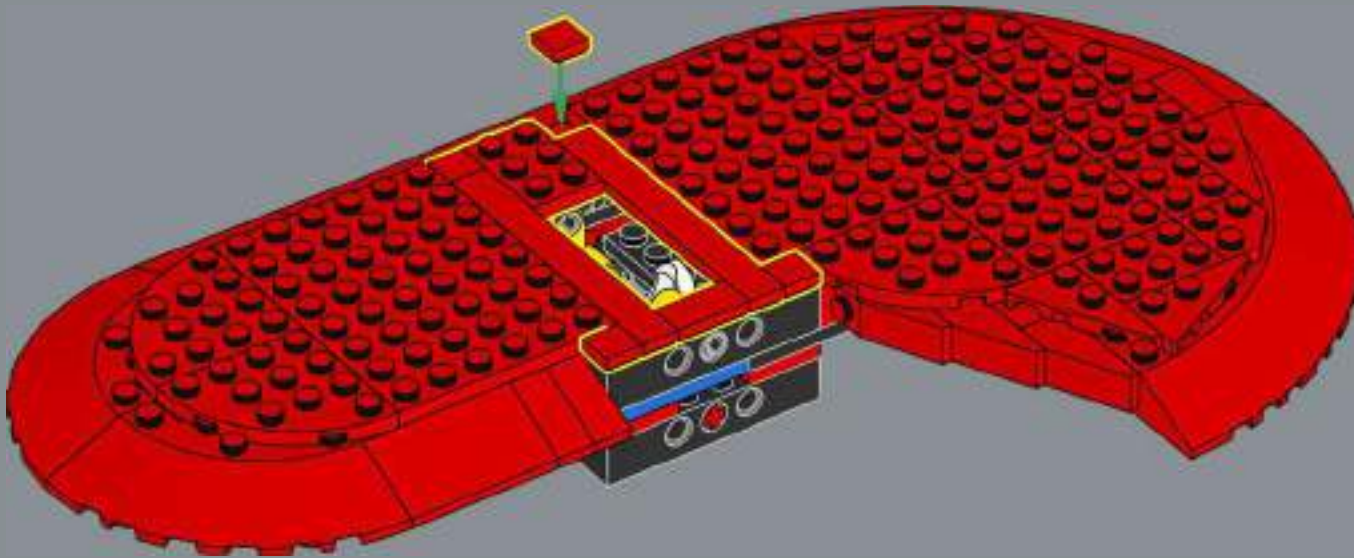

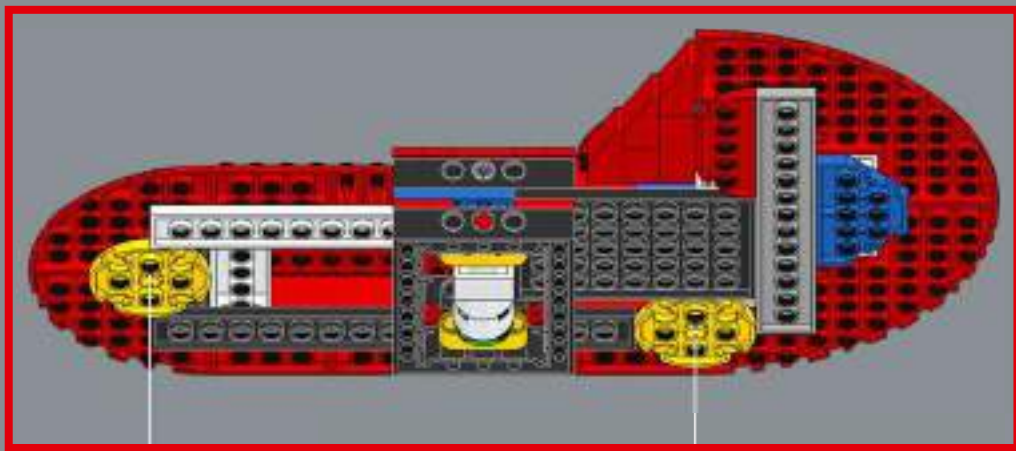

300

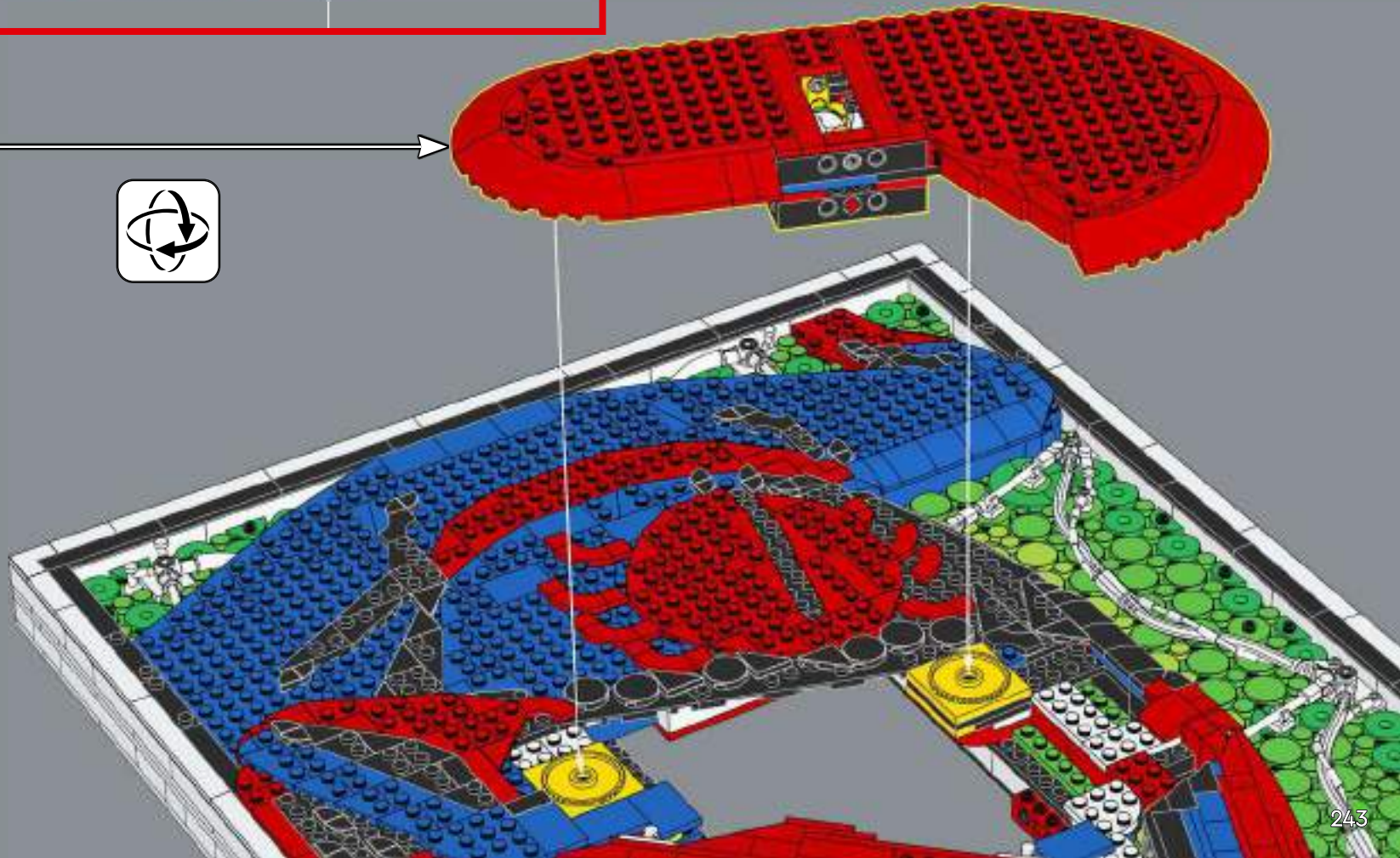

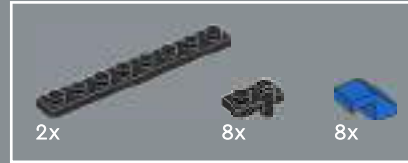

301

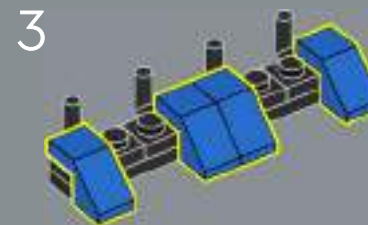
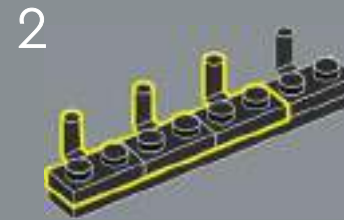
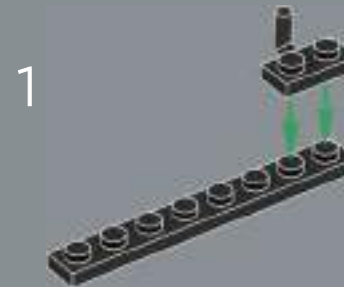

2x

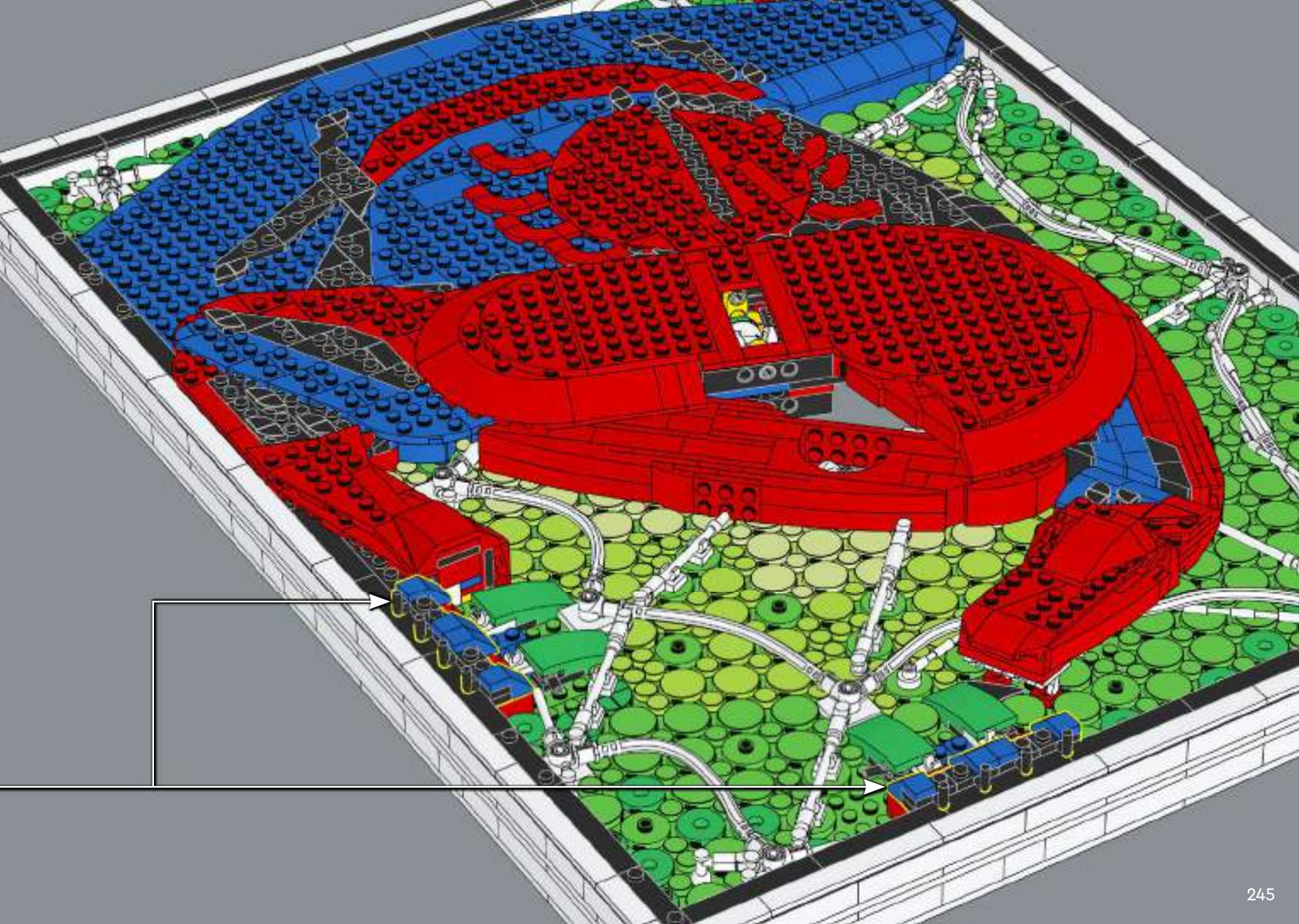

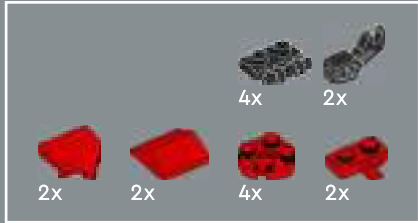

302

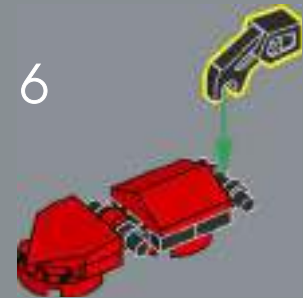
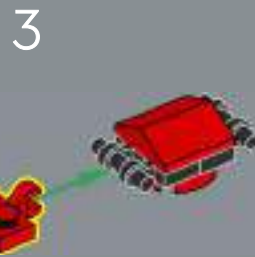

2x

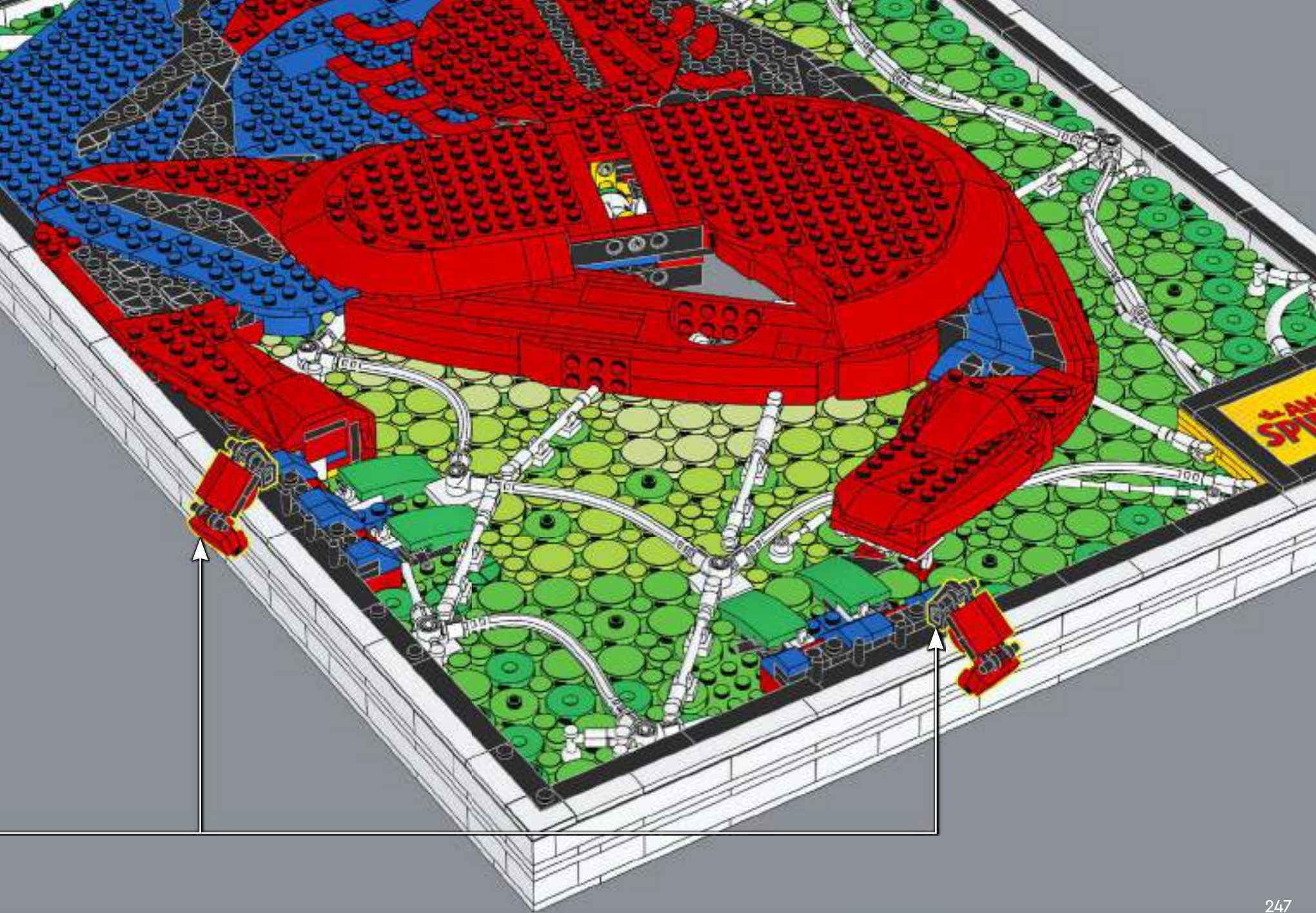



303

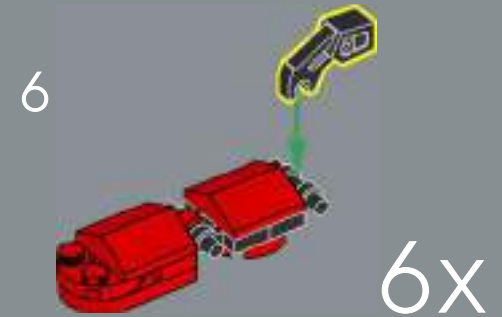
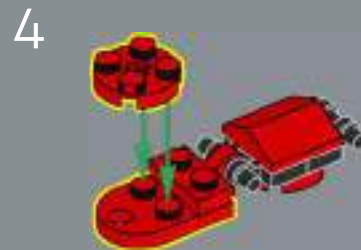
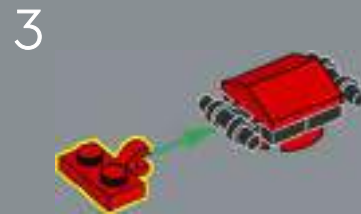

Spider-Man's exposure to mutated spider venom allows him to mentally control the flux of interatomic attraction between molecular boundary layers. Put simply, he can crawl on walls!

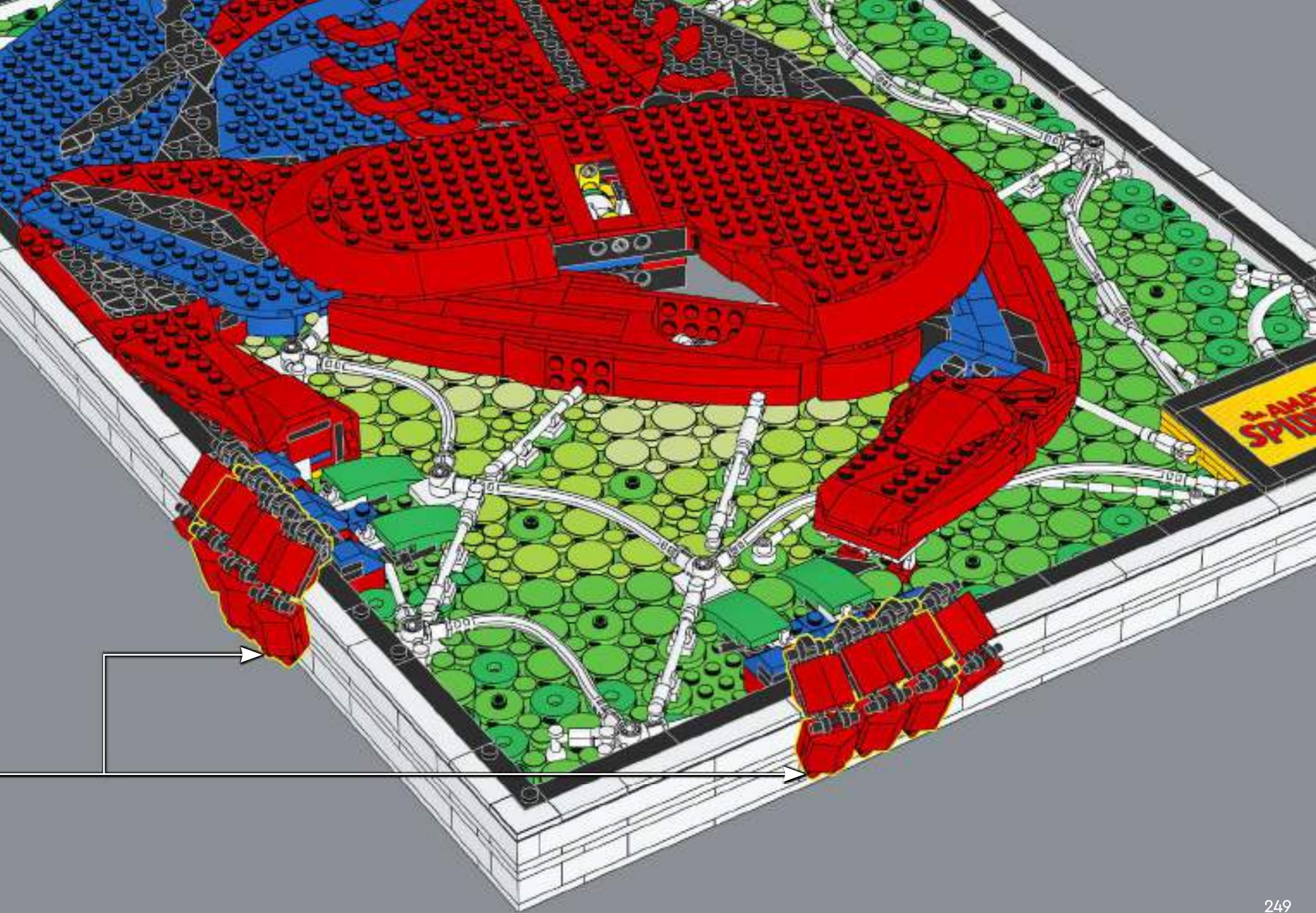



304

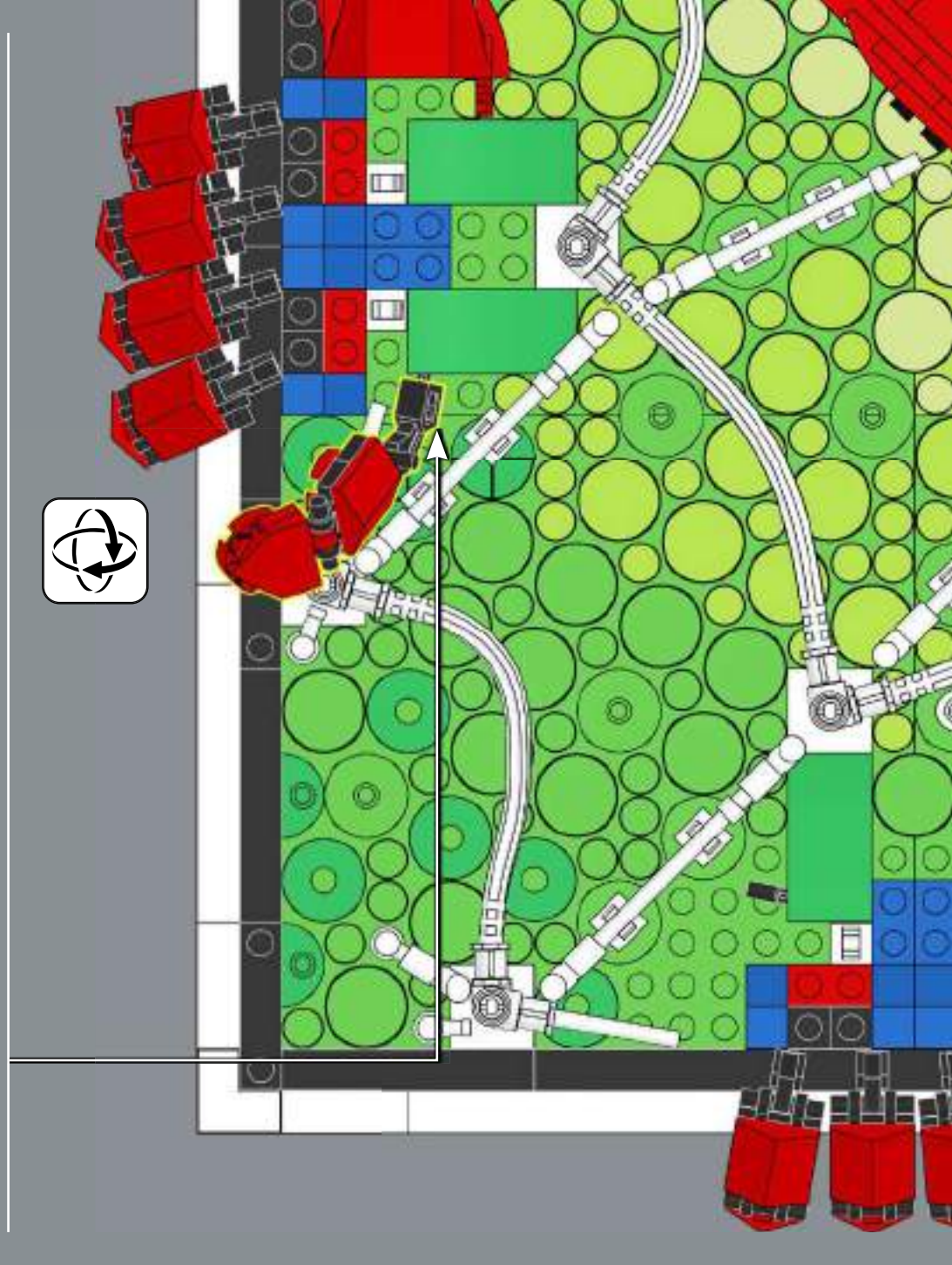
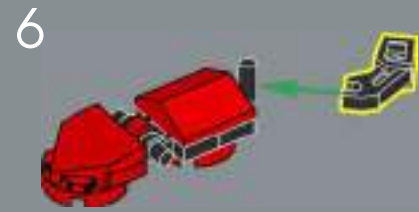



305

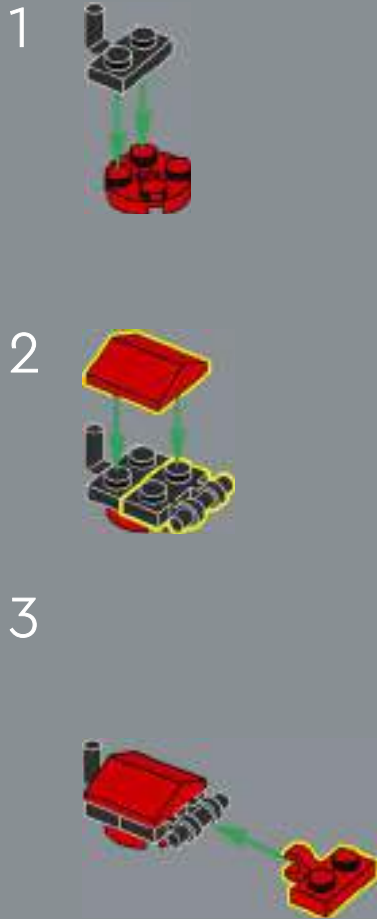

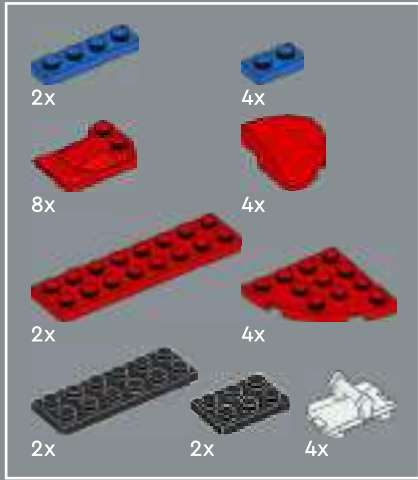

306

1

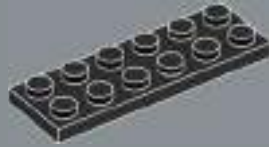

2

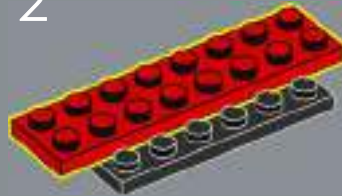

3



4

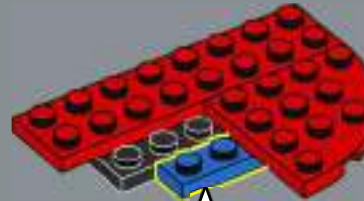

5



6



7



8



9

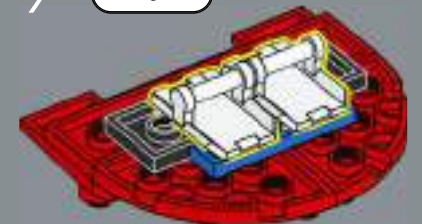

2x



Play with pointy poses: Move Spider-Man's fingers into different poses – try his web-slinging pose!

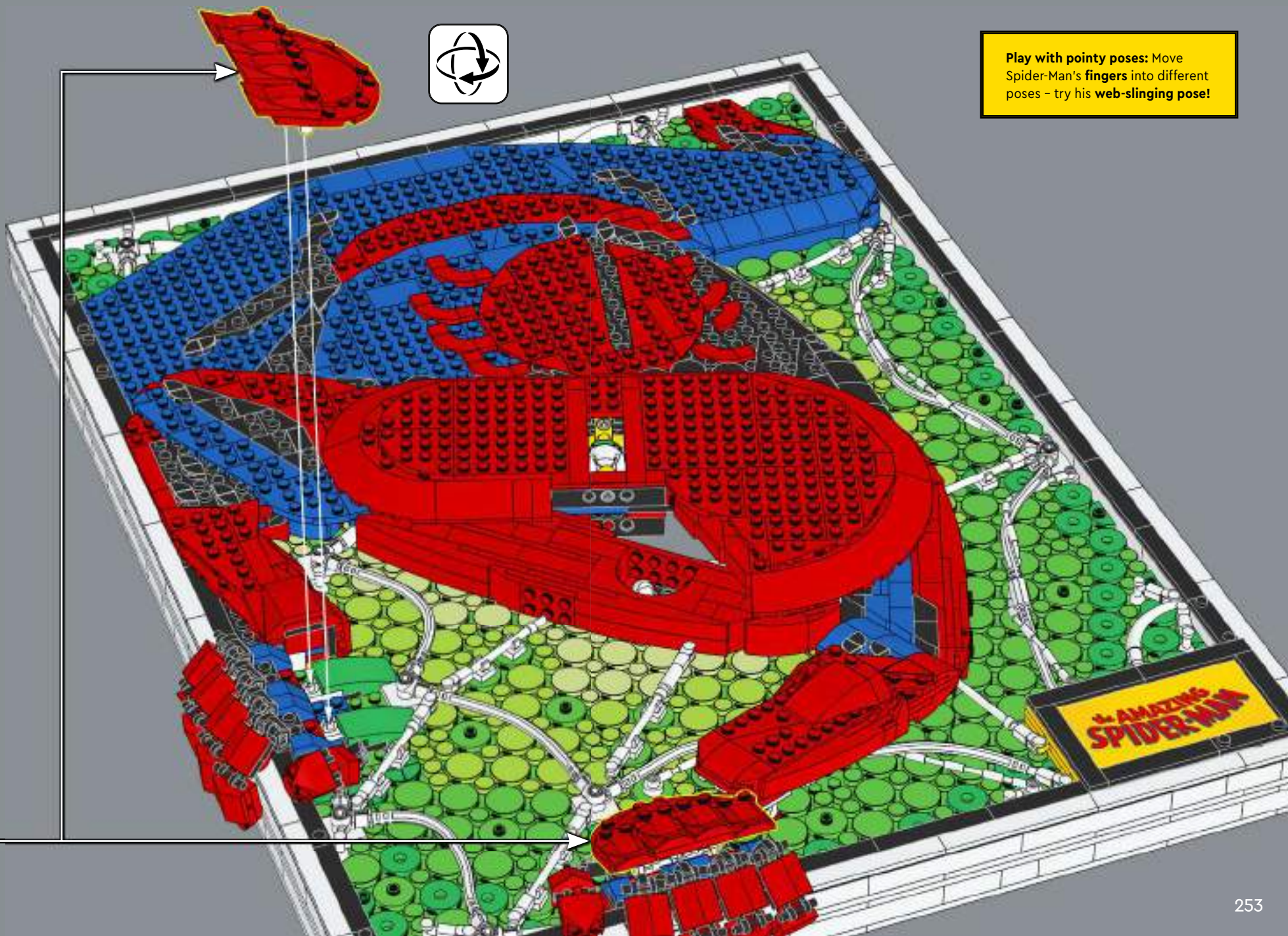

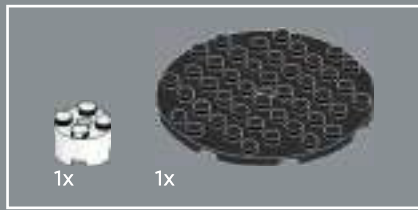
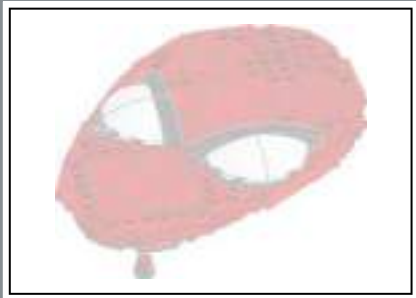

307



308

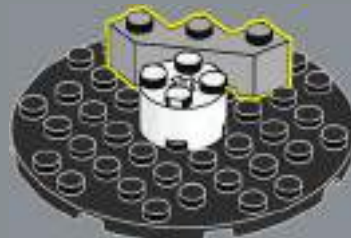

309

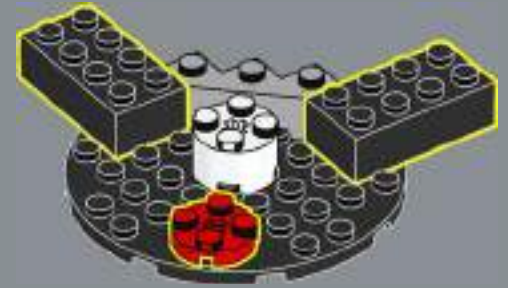

310





311



312

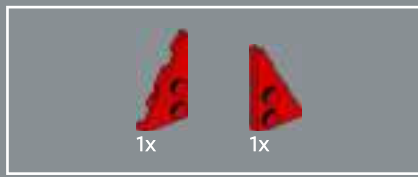

313



314



315



316





317

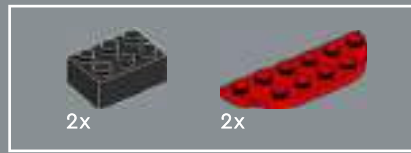
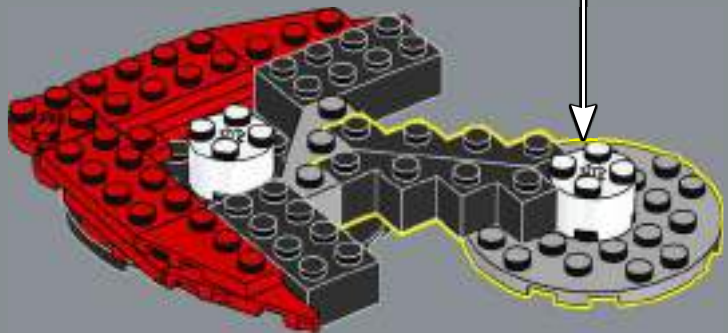
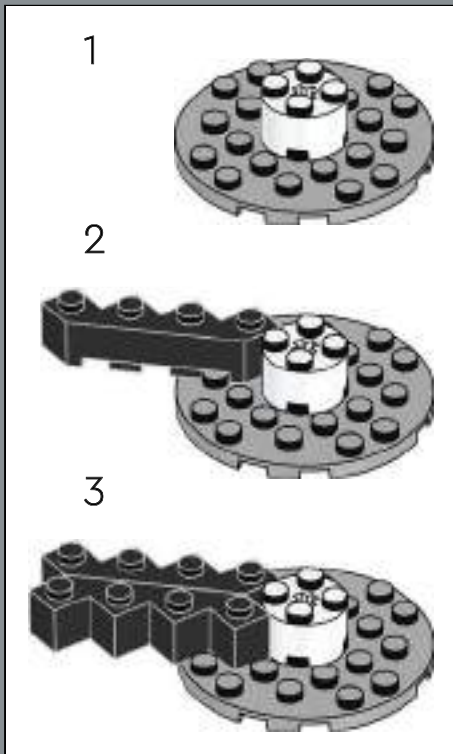

318

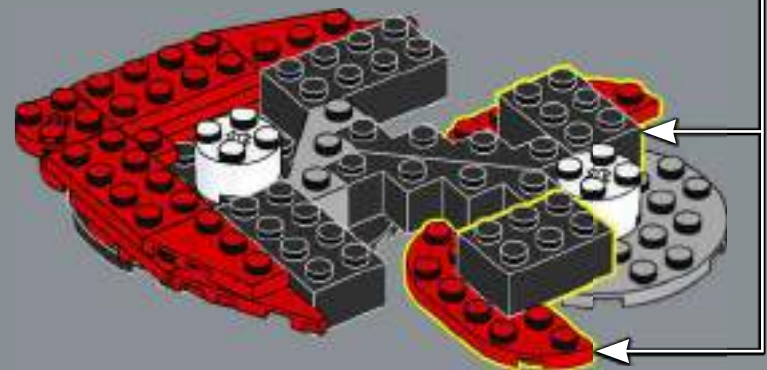
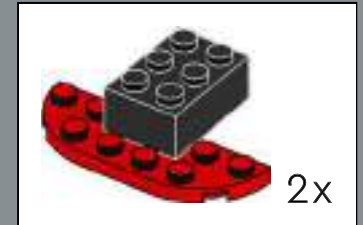



319

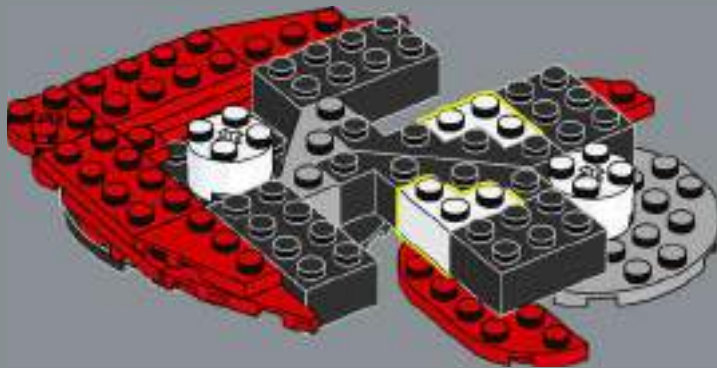

320

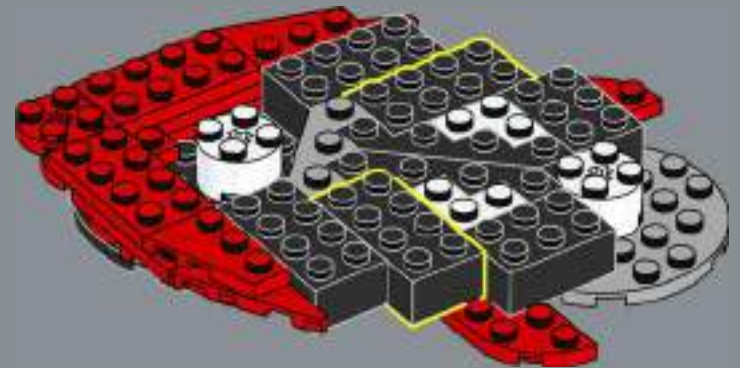

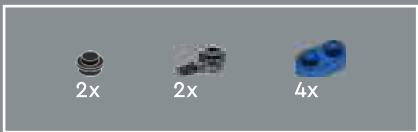

321

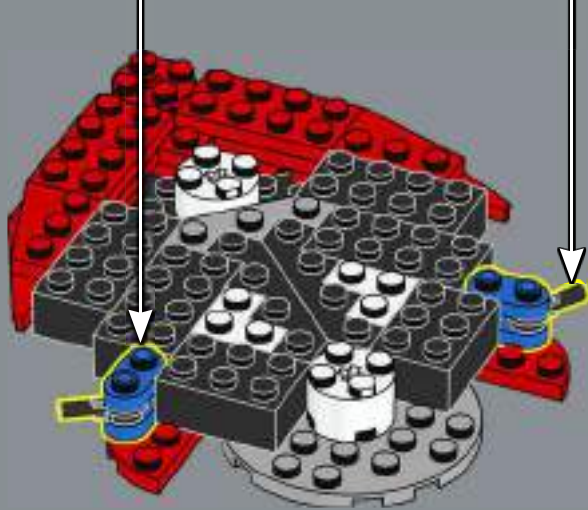
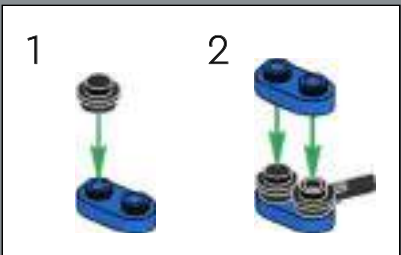
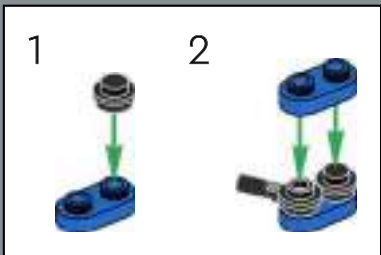

322

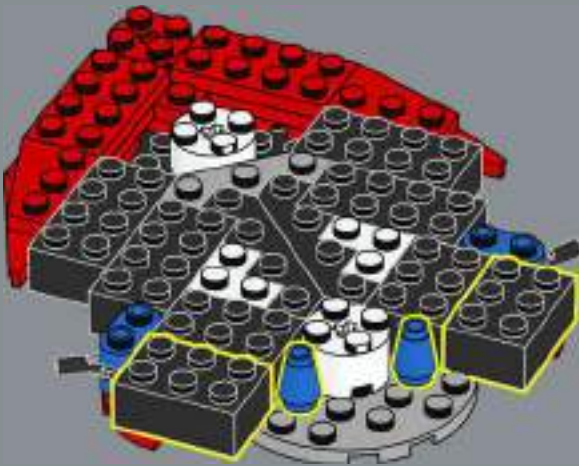

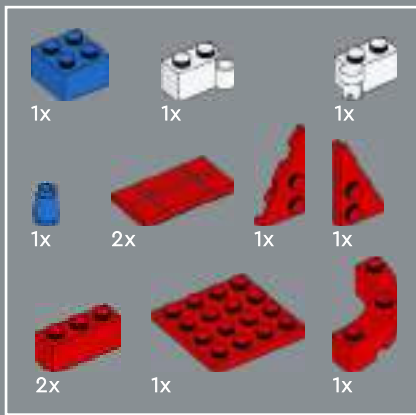

323

1

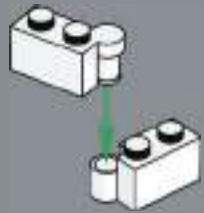

2



3



4

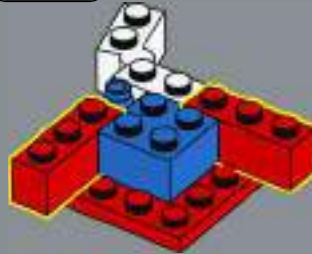

5



6



7

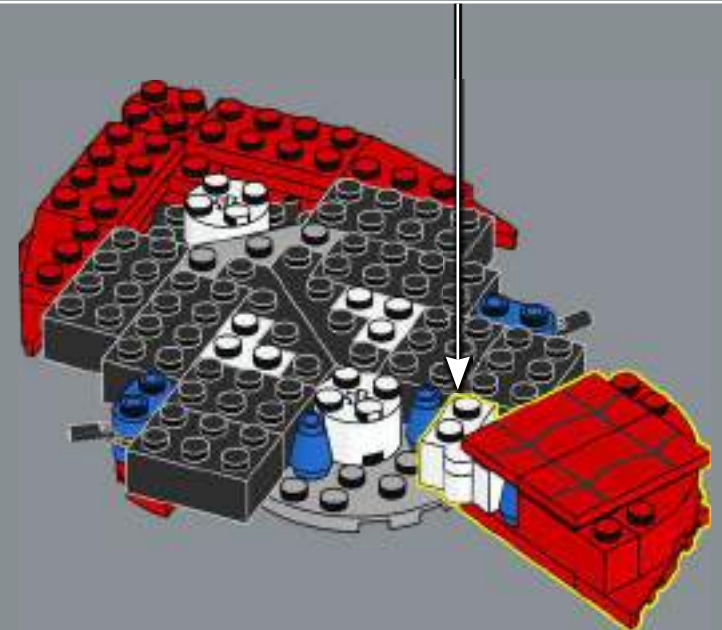

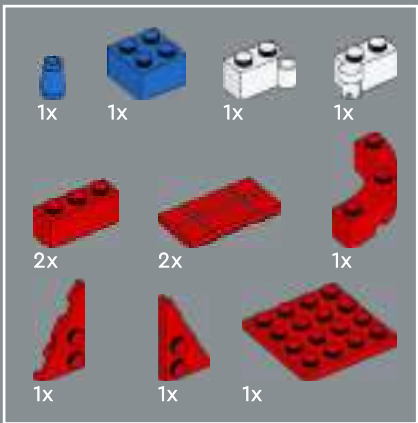

324

1

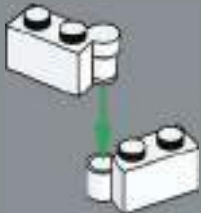

2



3



4

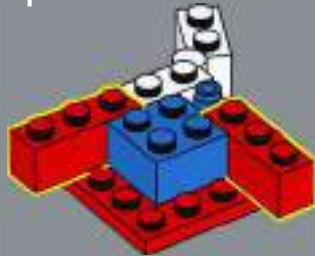

5

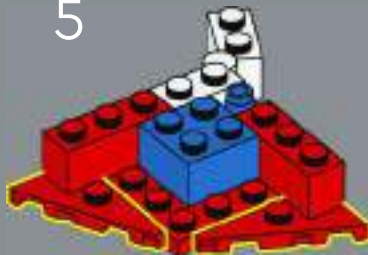

6



7

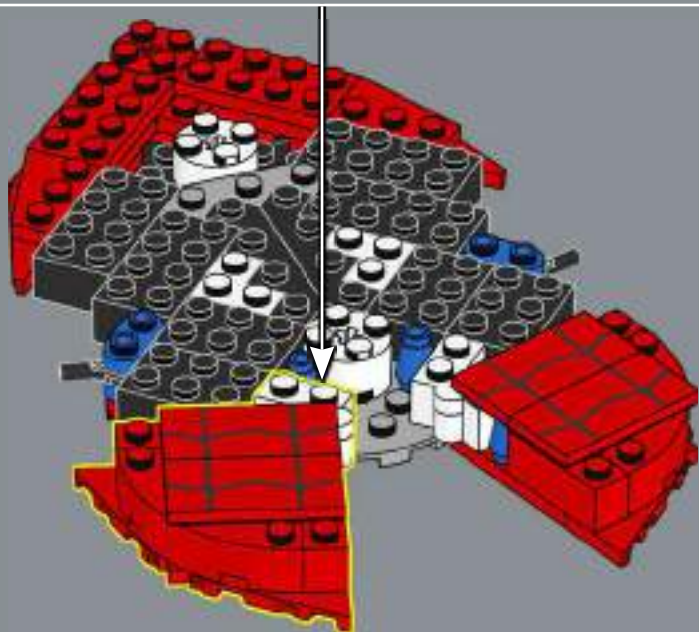

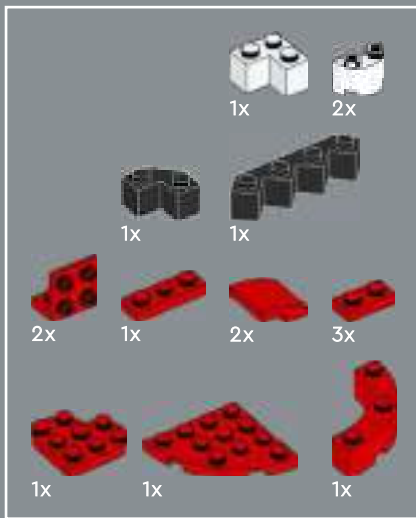

325

1



2



3



4

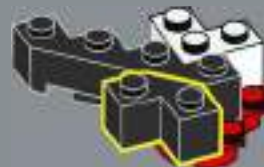

5



1

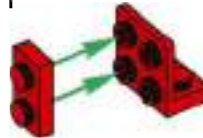

2



6



1

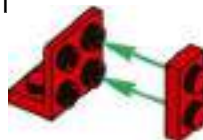

2



7



8



9



10





326

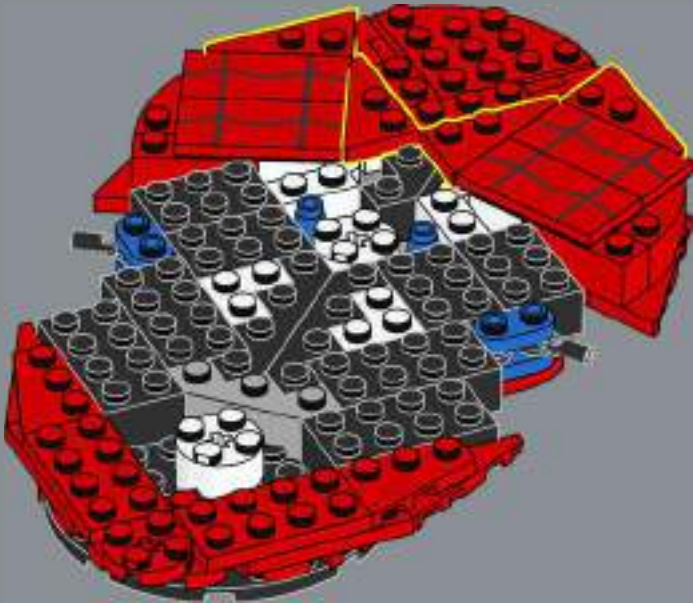
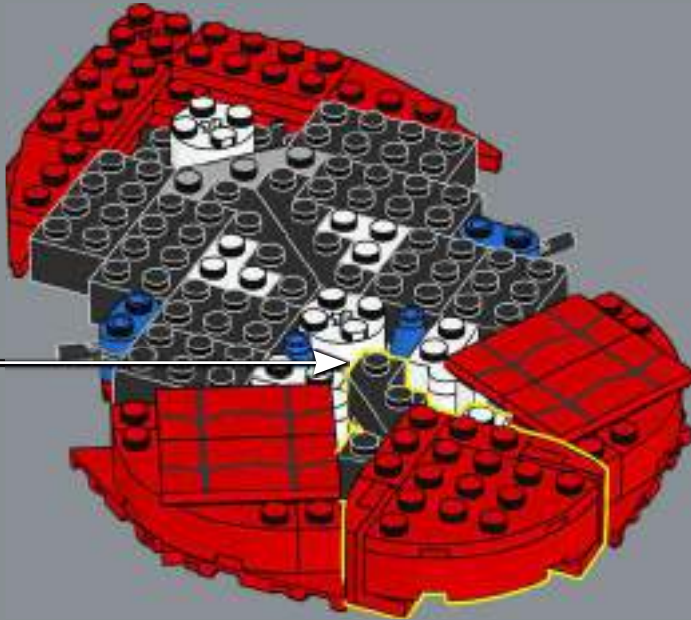

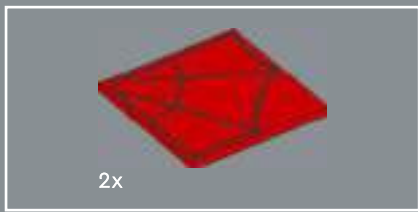

327

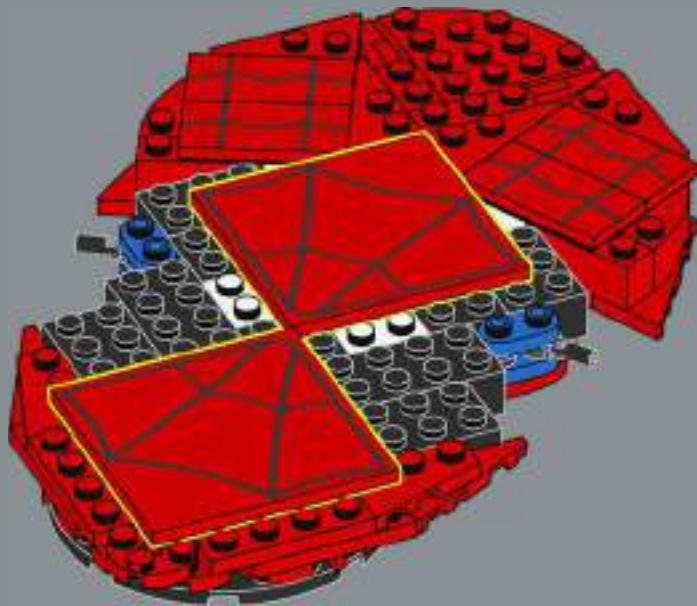

328

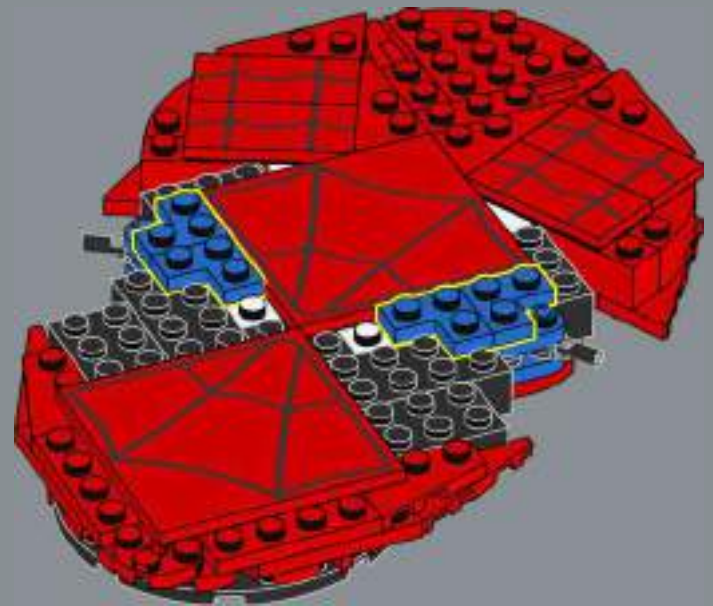

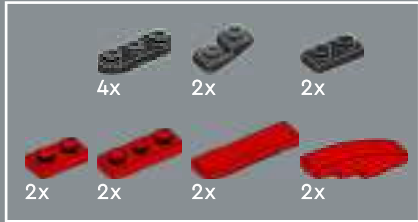
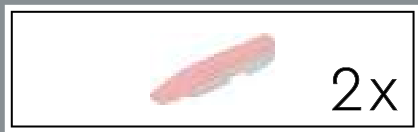

329

1



2



3

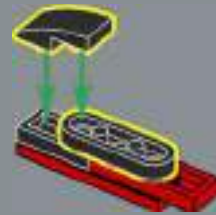

4

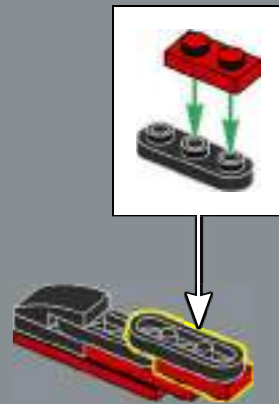

5

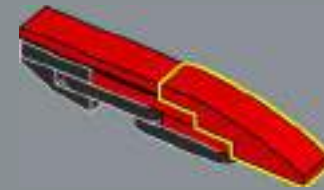

2x

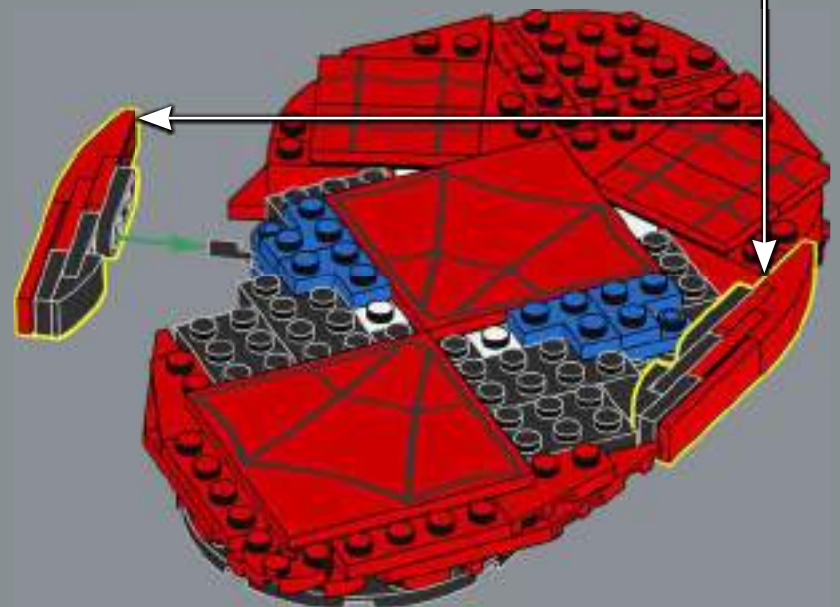



330

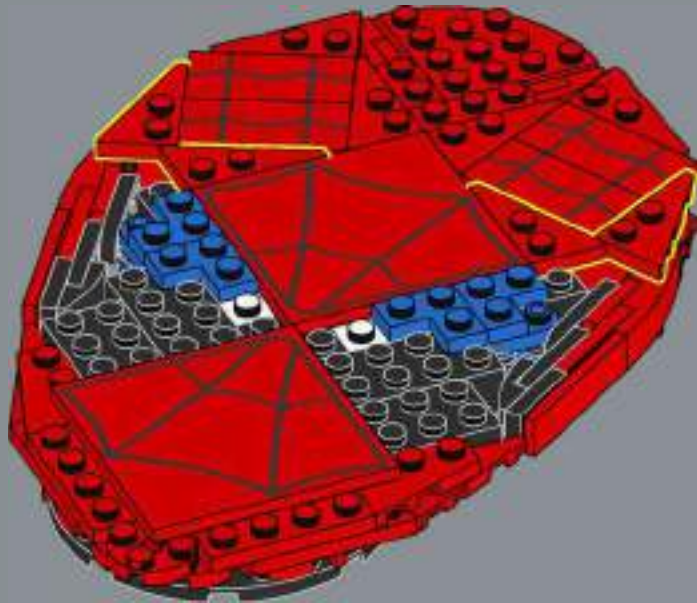

331

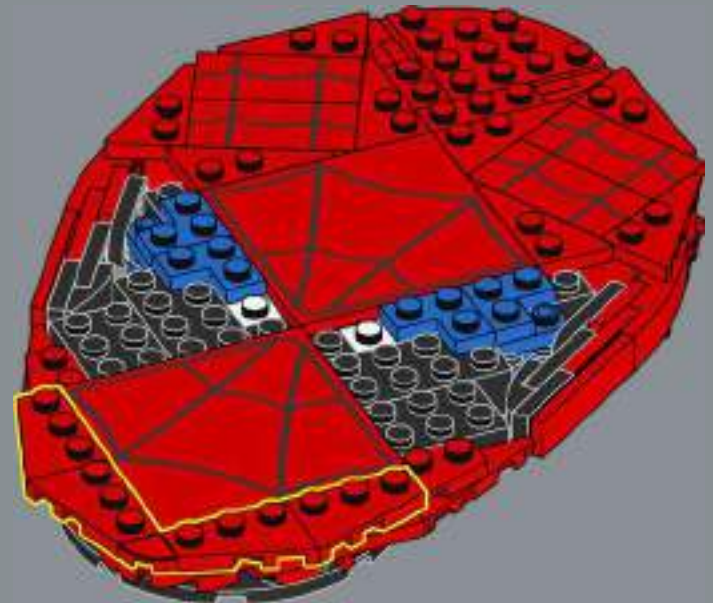



332

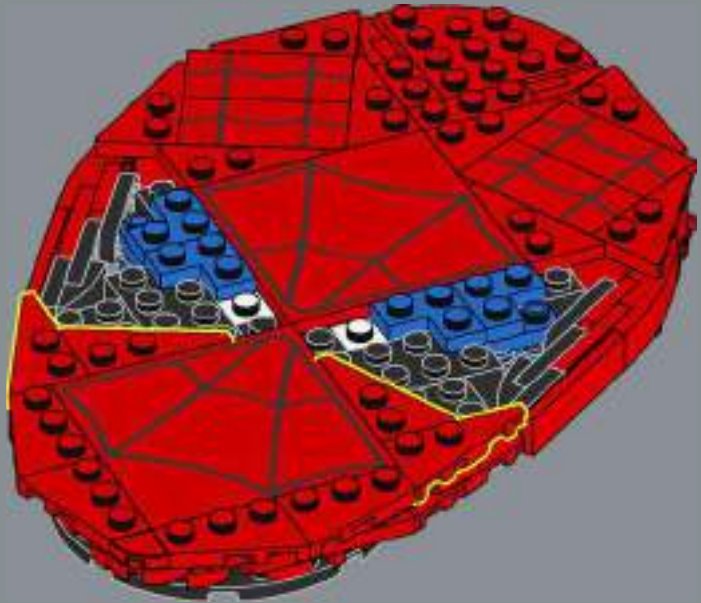

333

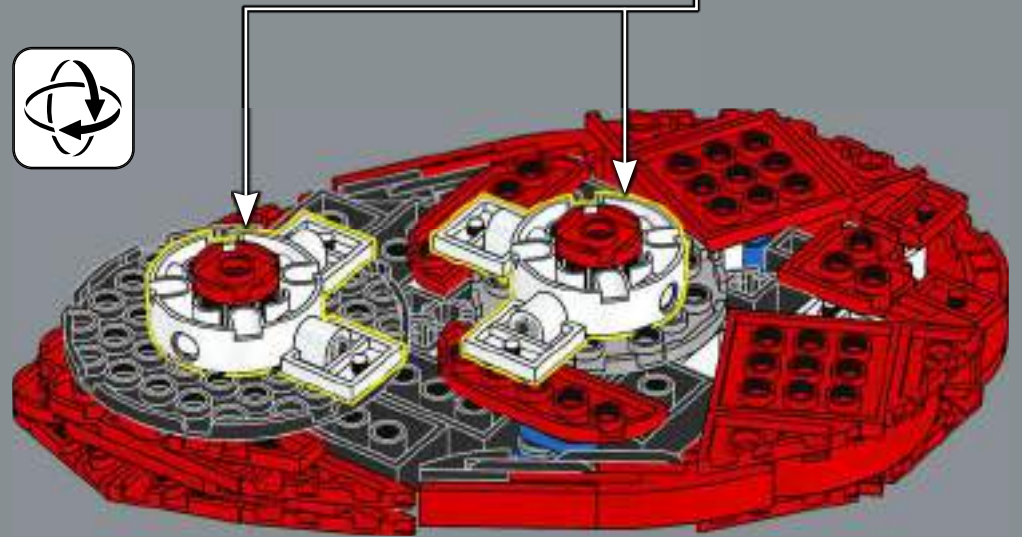
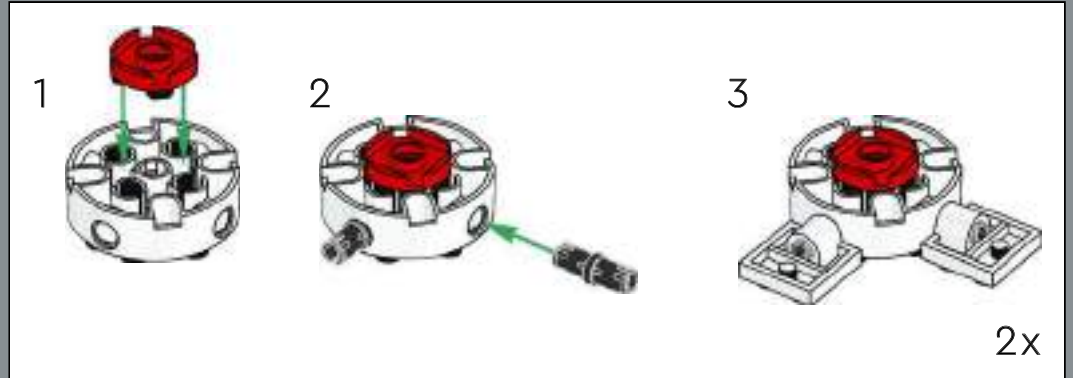



334

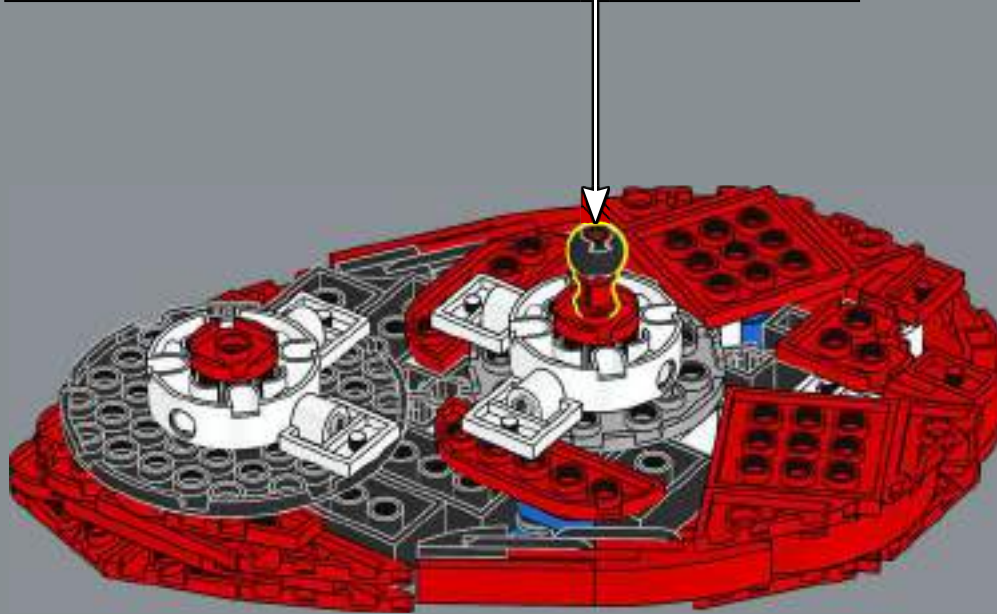
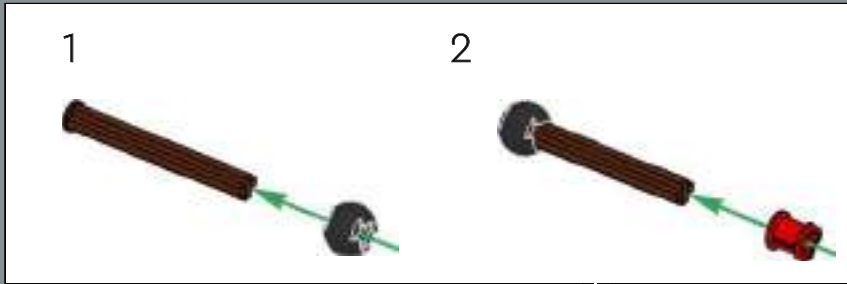



335

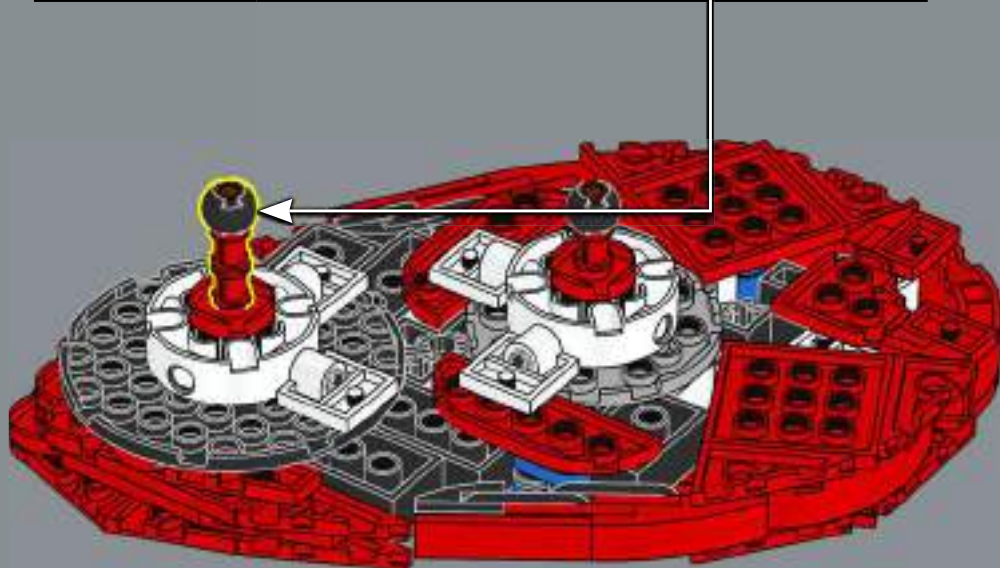
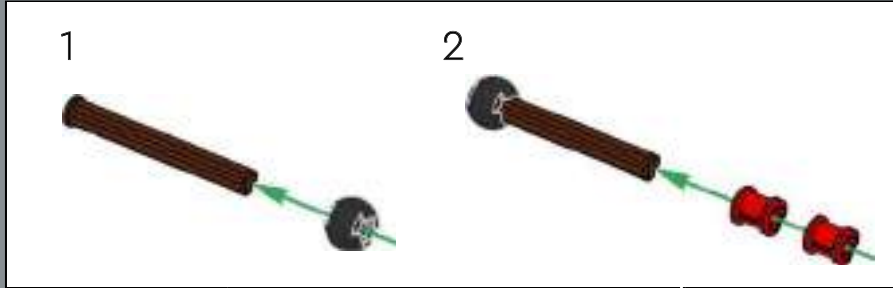

336

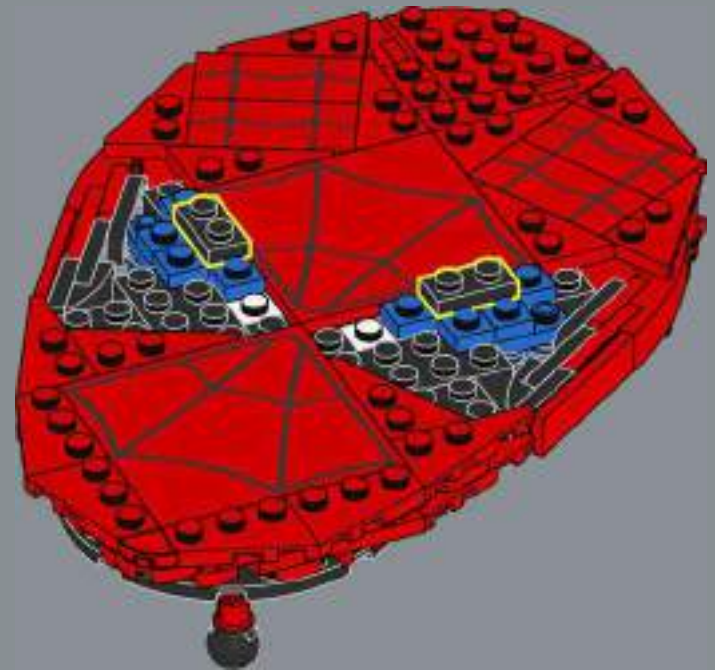



337

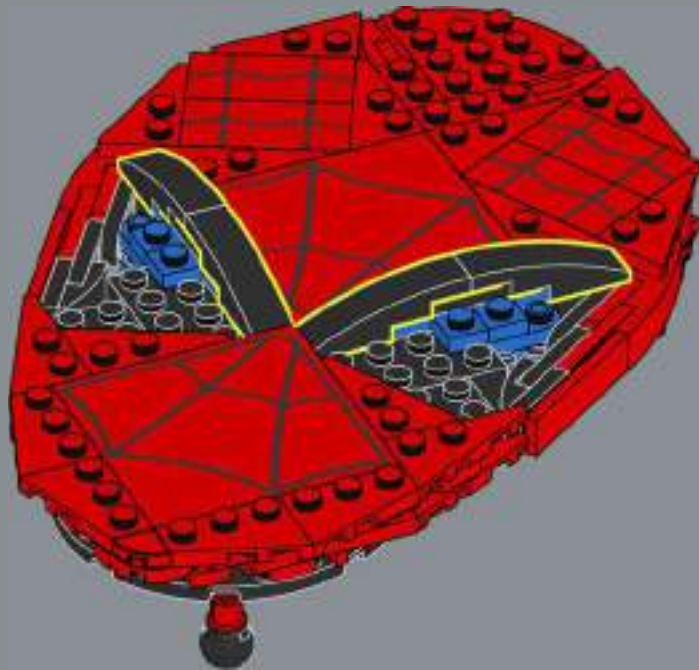

338



Turn Spider-Man's head **from side to side** - watch how his face **changes expressions!** The **sphere elements** create an **optical illusion** when you see the face from different angles!

339

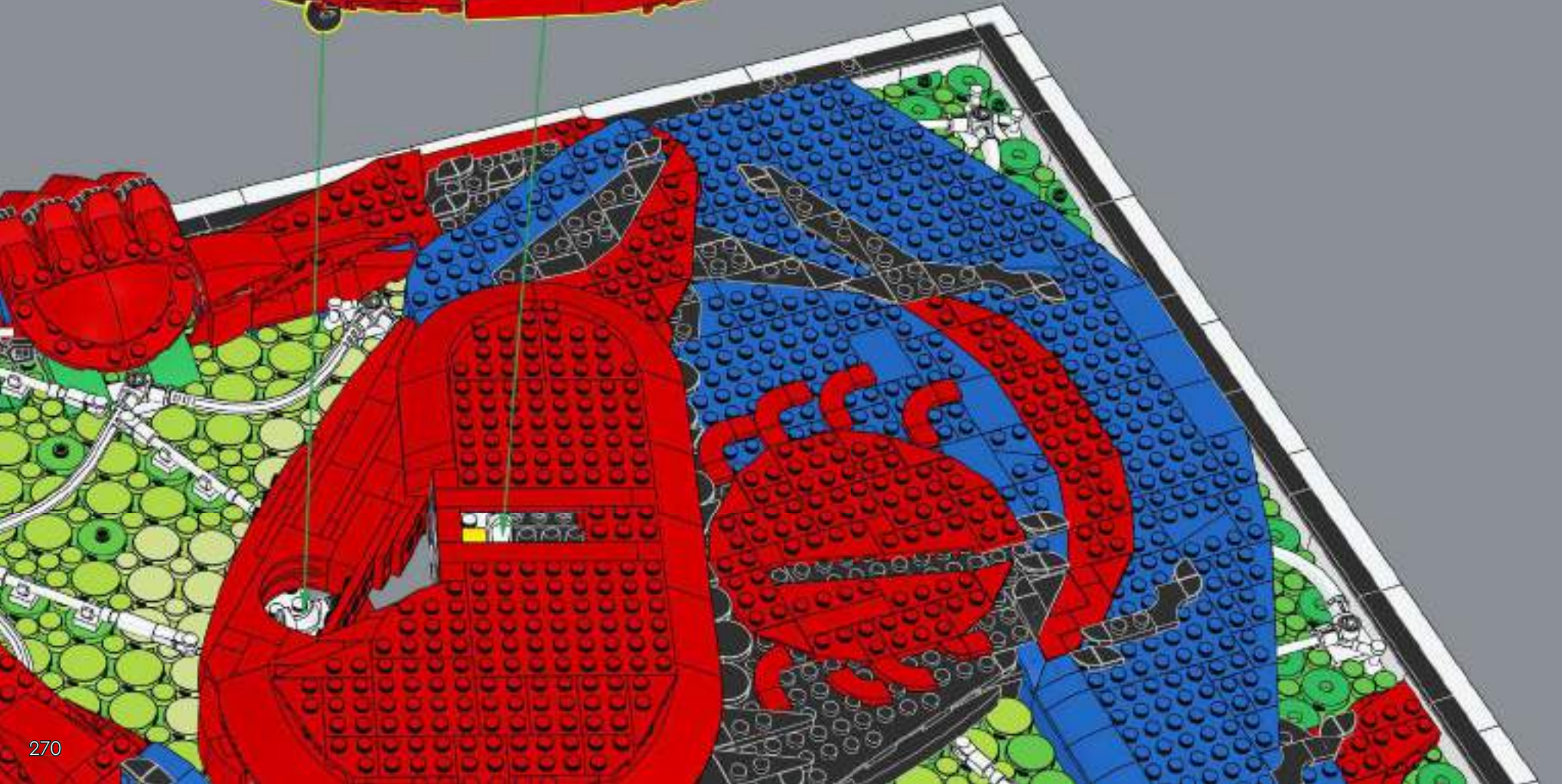
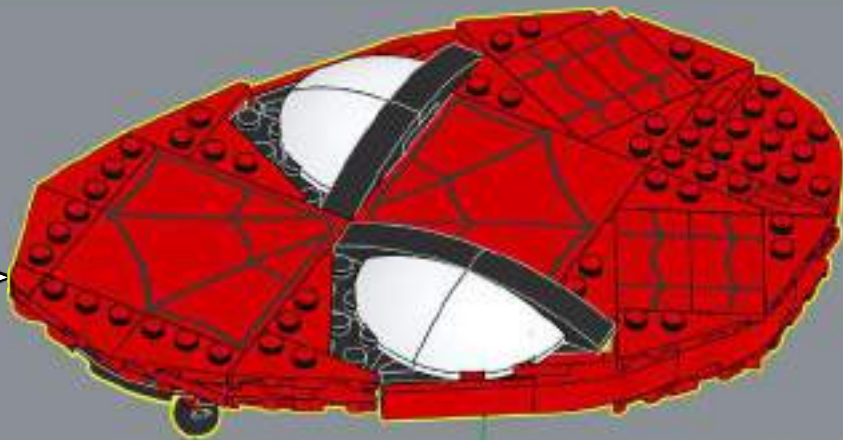



15x

340



Notice the **15 spiders** in the frame?
The number is an homage to the
first appearance of Spider-Man in
AMAZING FANTASY (1962) #15. Also,
Peter Parker was **15 years old** when
he gained his **powers**!

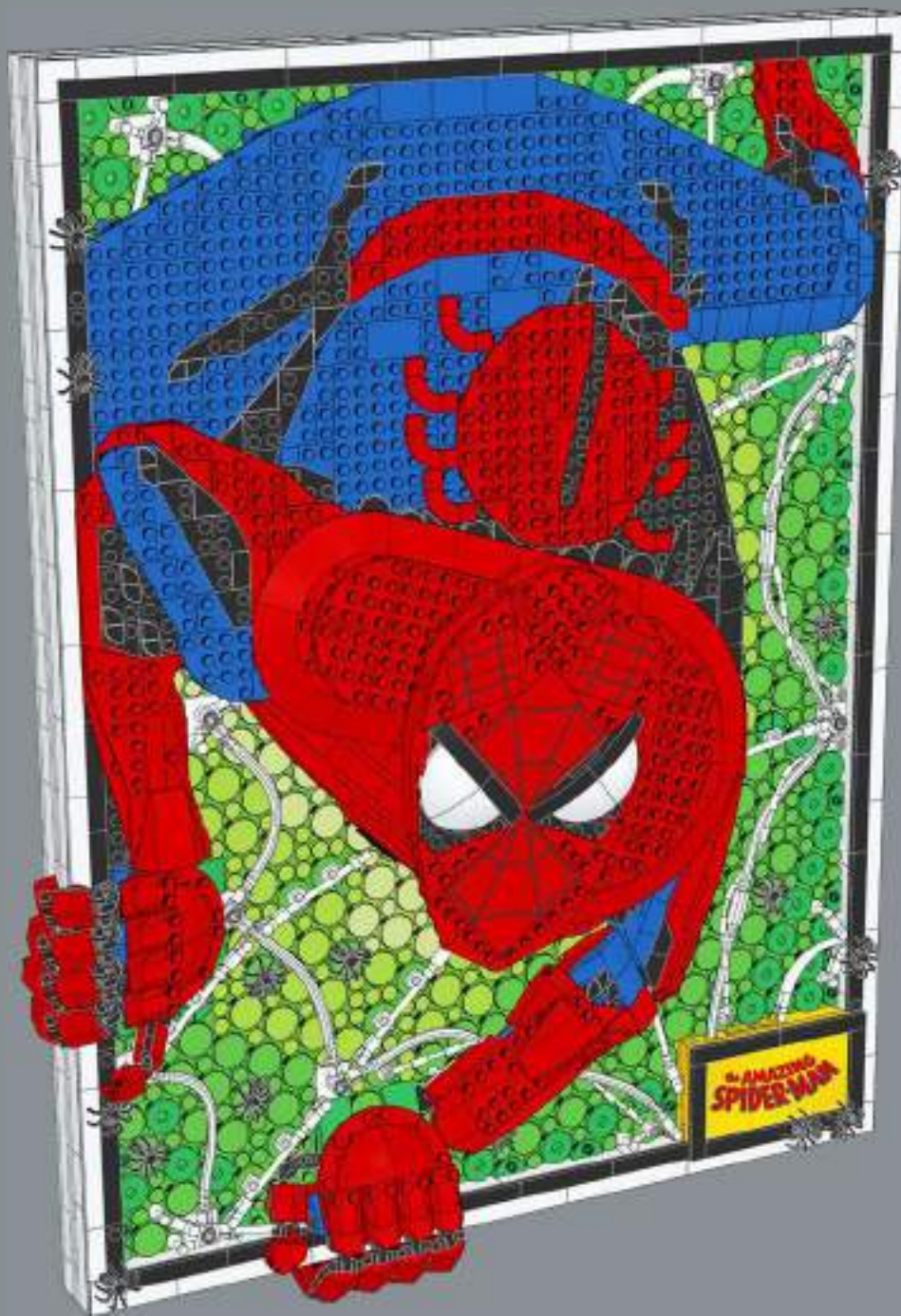

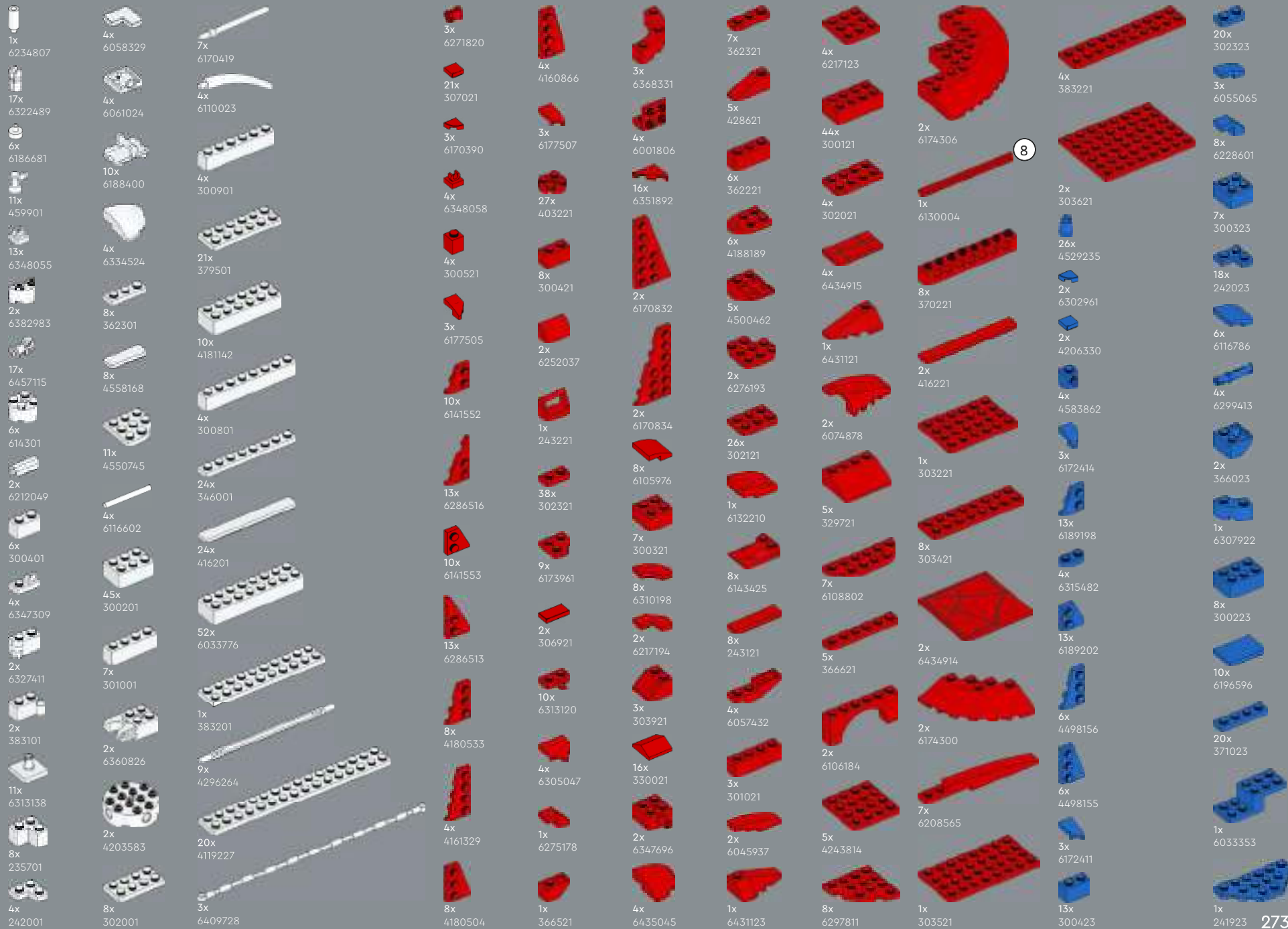



2x
6146306



5x
303223



3x
303423



7x
6037384



8x
303623



10x
4611777



LEGO.com/service

6x
6150607



19x
6424859



42x
6074954



4x
6365611



4x
6285601



154x
6353793



71x
6422433



24x
6380676

13x
614126



1x
6186698



2x
4286267



31x
6172383



3x
6181720



4x
6433936



5x
6141554



3x
6295295



5x
6141556



3x
6295293



3x
6181713

9x
306926



9x
302326



2x
370026



10x
6261348



2x
6147050



1x
4121966



1x
6250020



14x
6214807



15x
6234806



18x
4140588



9x
6428168



1x
4283047

1x
4283046

15x
302226

5x
6196548



10x
300226



1x
329826



7x
302126



7x
6254045



1x
371026



2x
6039869



4x
6037746



12x
300126



1x
4188534



3x
6039347



1x
370626

33x
663626

6x
6070695



10x
6276867



16x
379526



2x
6401209

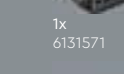

1x
6131571

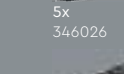

5x
346026



2x
6456527

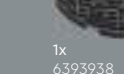

1x
6393938



1x
6037664



5x
4617860



4x
303626



13x
428226

14x
6279875



3x
6053077



3x
6425507



1x
4584274



1x
389426



2x
6101857



2x
6302094



2x
6448394



1x
303026



1x
6394881



1x
4143180



1x
428226

5x
6348065



15x
302324



6x
370024



2x
6247387



2x
6072627



1x
4558172



8x
371024



1x
301024



8x
4515349



2x
6310219



1x
6434916

27x
6284598



22x
6424480



2x
6159763



100x
6284583



42x
6092766



2x
6424330



1x
6240515



1x
6375710



2x
4494475



1x
6326478



1x
4211718



1x
6015349

1x
4662161

5

6



YOU COULD WIN



YOU COULD WIN

Your feedback will help shape the future development of this product series.

Visit:

DU KÖNNTEST GEWINNEN

Dein Feedback trägt zur Weiterentwicklung dieser Produktreihe bei.

Geh auf:

VOUS POURRIEZ GAGNER

Vos commentaires nous aideront à concevoir les futurs produits de cette gamme.

Visitez :

POTRESTI VINCERE TU

La tua opinione ci aiuterà a migliorare la creazione futura di questa linea di prodotti.

Visita:

PUEDES GANAR

Tu opinión contribuirá al futuro de esta serie de productos.

Visita:

轻松获奖

您的反馈将有助于我们在今后改进本产品系列。

请访问:

LEGO.com/productfeedback

You also have the chance to win a LEGO® set.

Terms and conditions apply.*

Außerdem hast du die Chance, ein LEGO® Set zu gewinnen.

Es gelten die Teilnahmebedingungen.*

Vous pourriez également gagner un ensemble LEGO®.

Des conditions s'appliquent.*

Hai anche la possibilità di vincere un set LEGO®.

Termini e condizioni sono applicabili.*

También tienes la oportunidad de ganar un set LEGO®.

Aplican términos y condiciones.*

您还有机会赢取乐高®套装。

条款和条件适用。*

*LEGO.com/productfeedback-terms

the AMAZING
SPIDER-MAN

LEGO and the LEGO logo are trademarks of the LEGO Group.

©2023 The LEGO Group. 6504256

© 2023 MARVEL