



DREAMZZZ

71456





 **FR**
DONNEZ
OU
RECYCLEZ

 OU  OU 

ASSOCIATION MAGASIN DÉCHÈTERIE

Adresses sur quefairedemesdechets.fr



LEGO.com/sustainable-packaging



BUILDER



Apple and the Apple logo are trademarks of Apple Inc., registered in the U.S. and other countries and regions. App Store is a service mark of Apple Inc.

Google Play and the Google Play logo are trademarks of Google LLC.

Tencent and the Tencent logo are trademarks of Tencent Inc.

Q [LEGO.com/devicecheck](https://www.lego.com/devicecheck)

EN Ask parents' permission before going online | **DE** Eltern um Erlaubnis bitten, bevor du online gehst | **FR** Demande l'autorisation d'un parent avant d'aller en ligne | **IT** Chiedi il permesso ai tuoi genitori prima di andare online | **ES** Pídeles permiso a tus papás antes de conectarte a Internet | **PT** Pede autorização aos pais antes de acederes online | **ZH** 上网前应先征得父母的同意 | **PL** Poproś rodziców o zgodę, zanim wejdiesz do Internetu | **CS** Než půjdeš na internet, požádej rodiče o svolení | **SK** Skôr než pôjdeš na internet, vypýtaj si povolenie od rodičov | **HU** Kérj szülői engedélyt, mielőtt online csatlakoznál! | **RO** Cere permisiunea părinților înainte de a te conecta online | **BG** Поискайте разрешение от родител, преди да влезете онлайн | **LV** Pirms došanās tiešsaistē palūdz atļauju vecākiem | **ET** Enne Interneti kasutamist küsi vanematelt luba | **LT** Prieš prisijungdami prie interneto, atsiklauskite tėvų





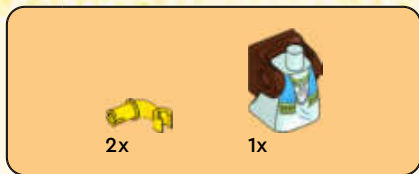

1





1x



1x

2



1x



1x



1x

3

1



2

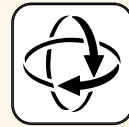

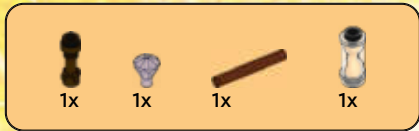

4





H 5'000 S

POP

POP

POP

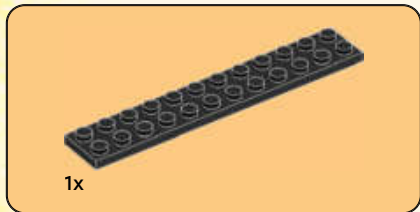

1

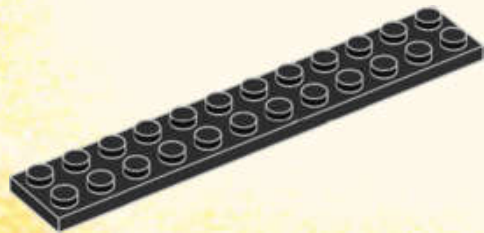

2

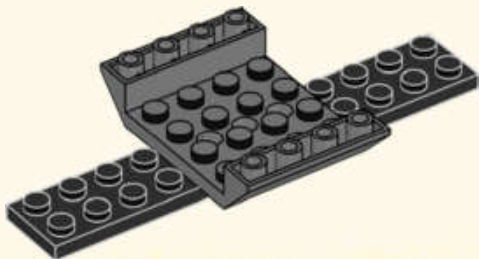

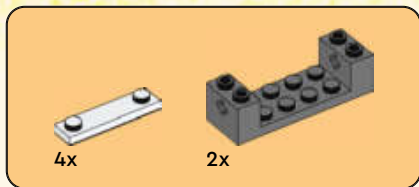

3

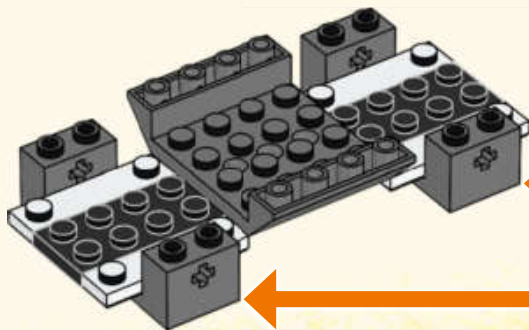
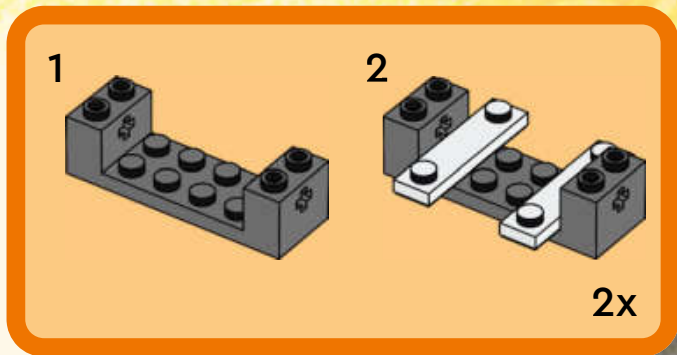

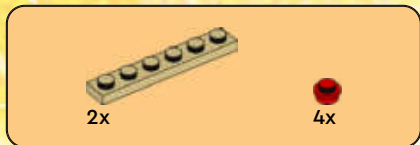

4

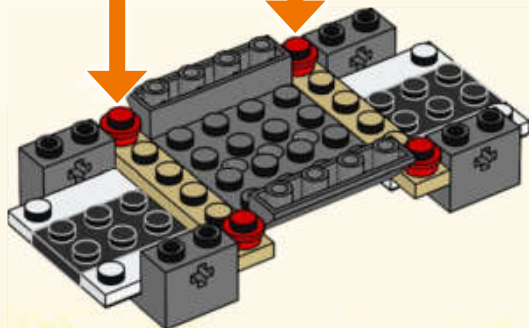
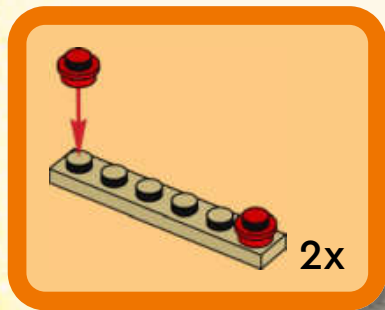



4x

5



4x

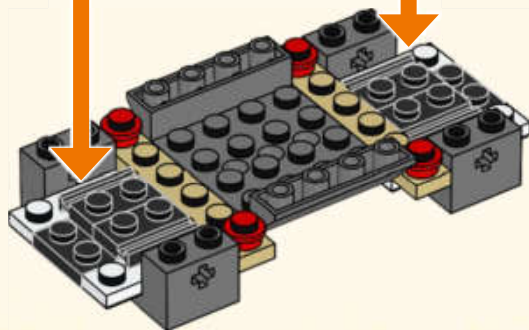

4x



2x

6

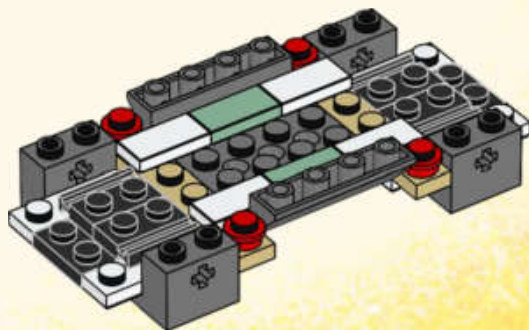



1x



2x

7

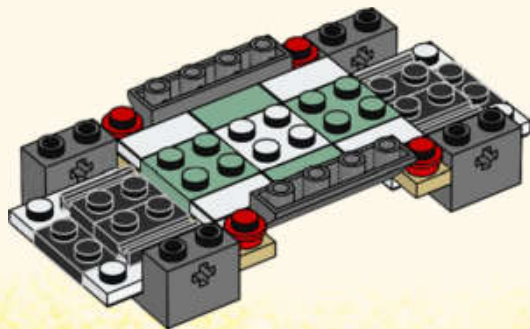

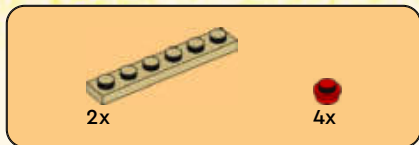

8

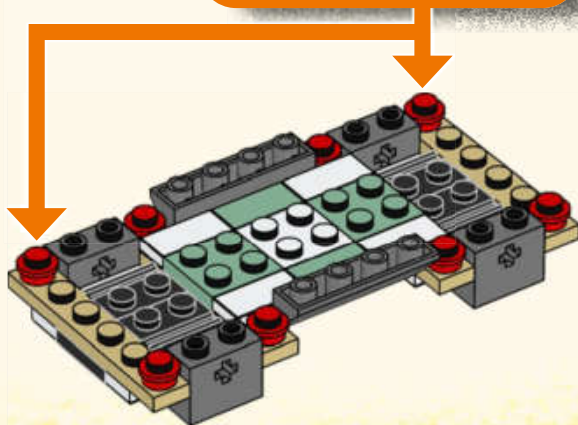
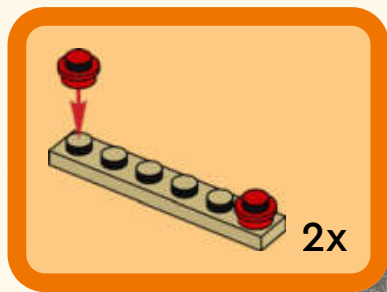

9

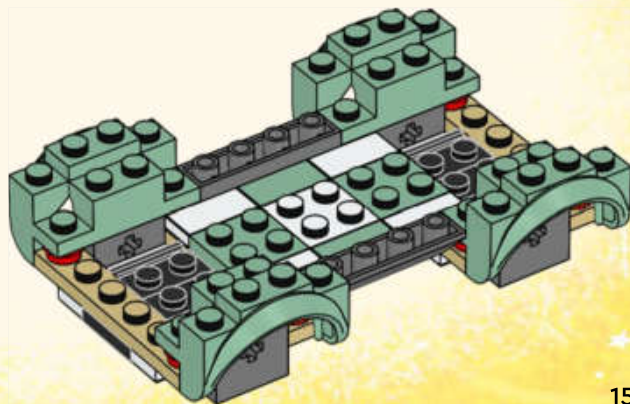



2x

10

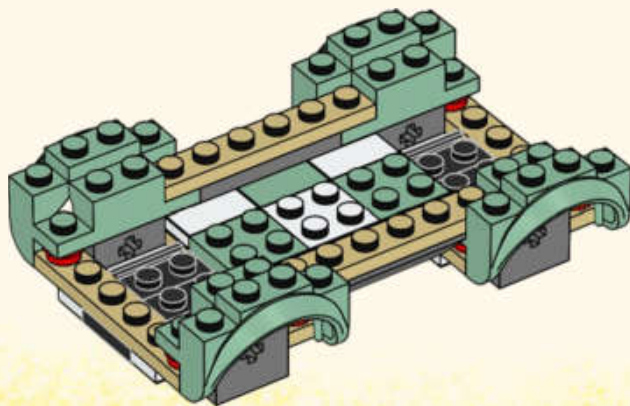



4x

11



4x

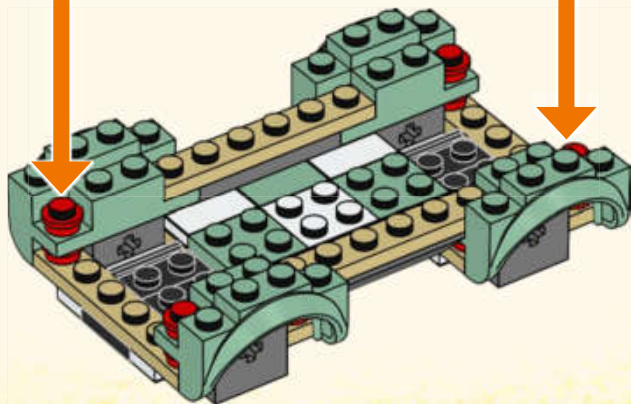

2x

12



2x

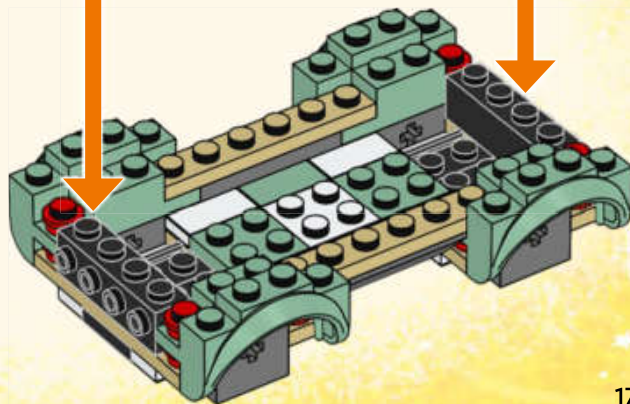

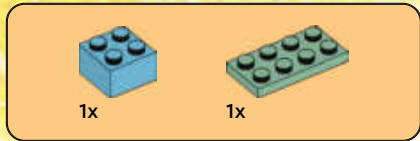

13

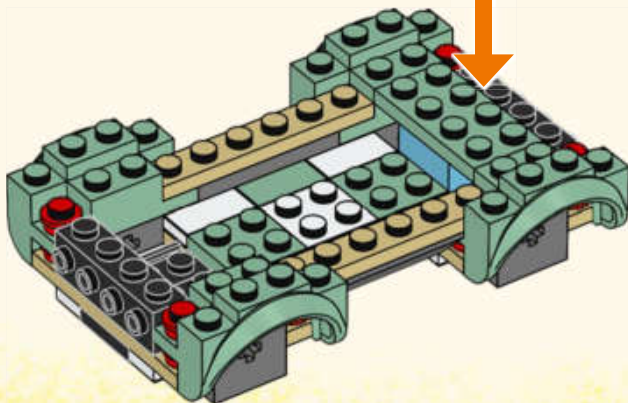
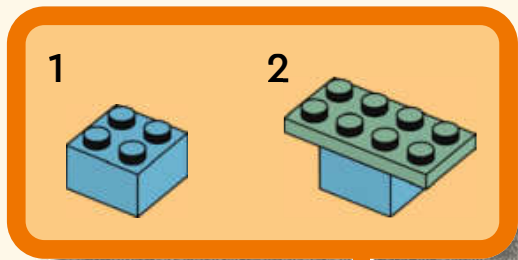



3x

14

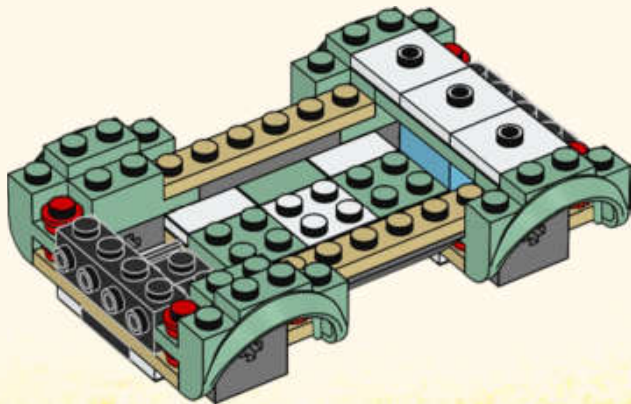

2x



2x



1x

15

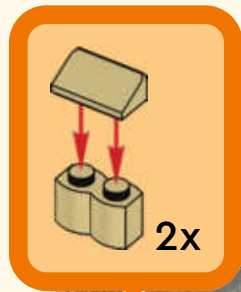

2x

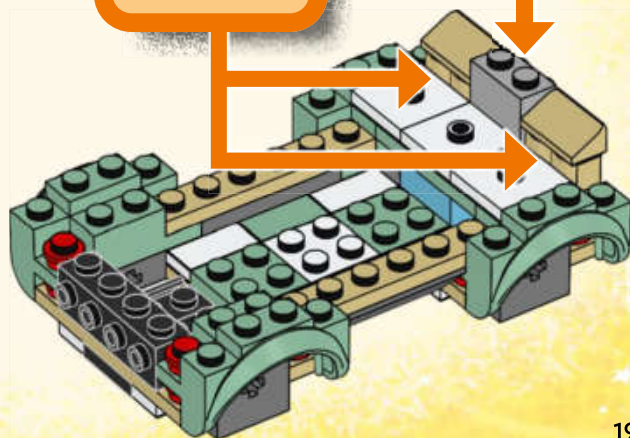

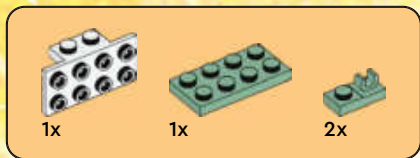

16

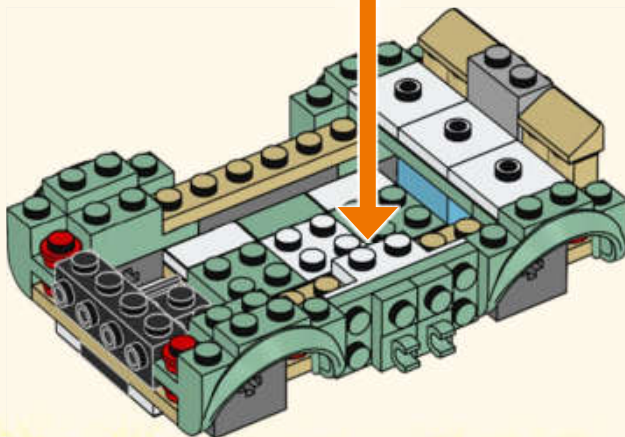
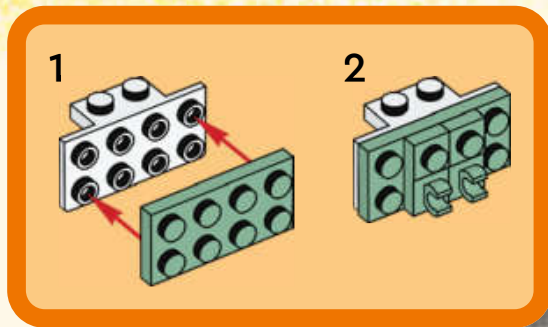



17

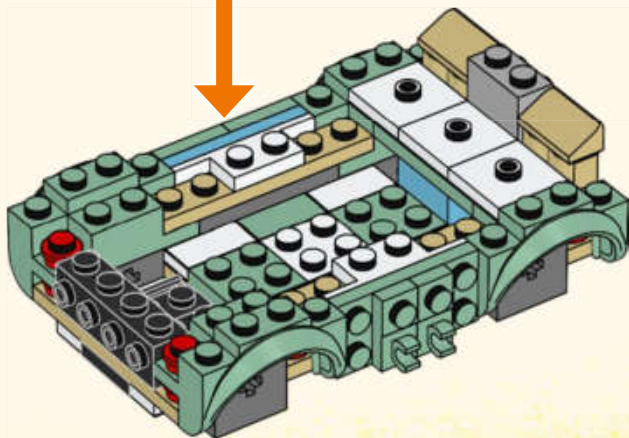
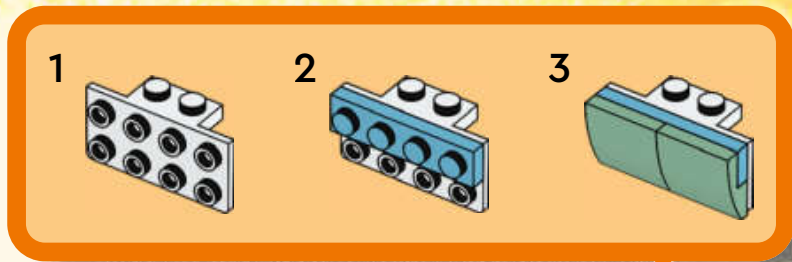

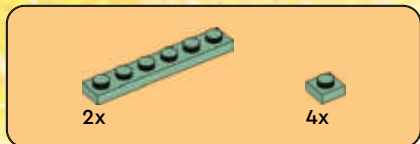

18

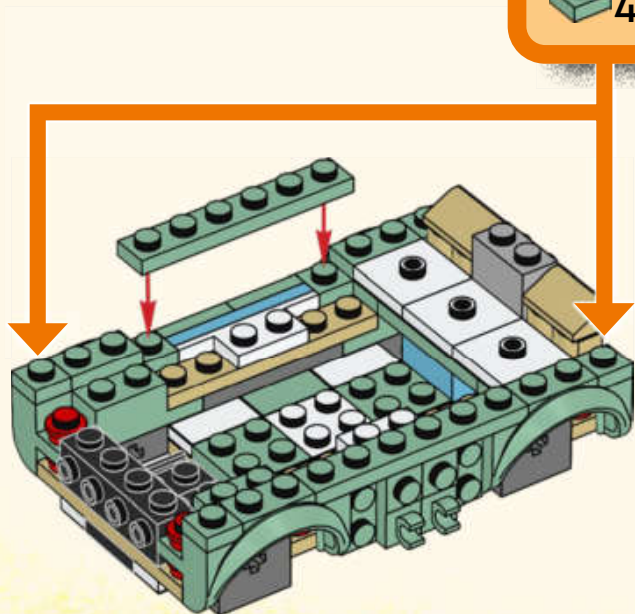



19

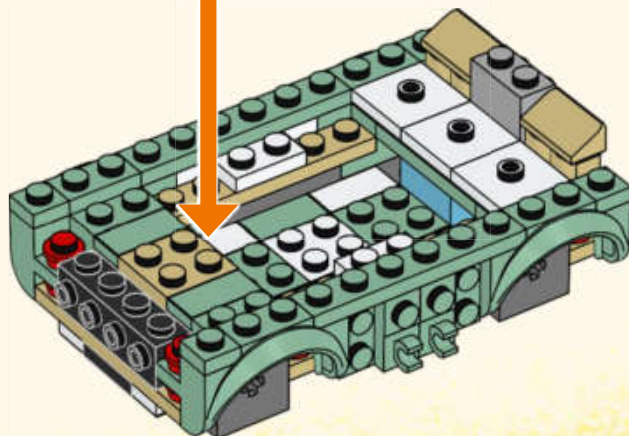
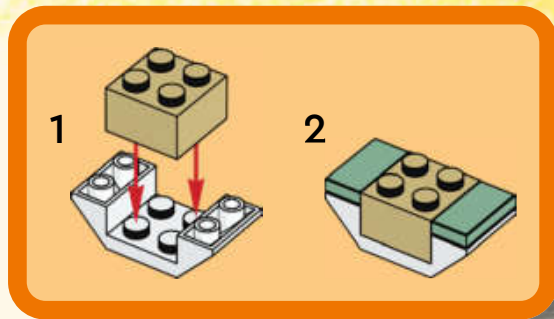



2x



1x

20

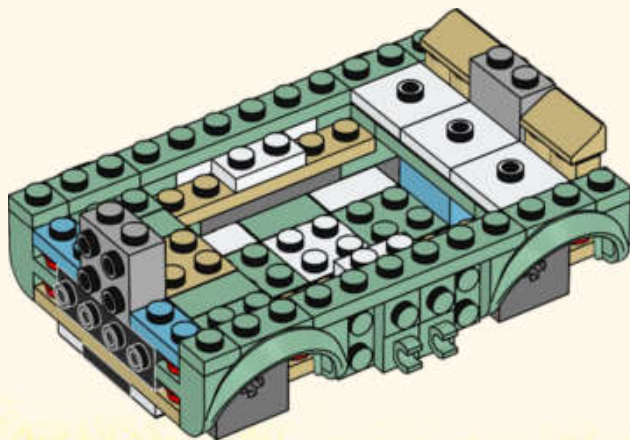



2x



1x

21

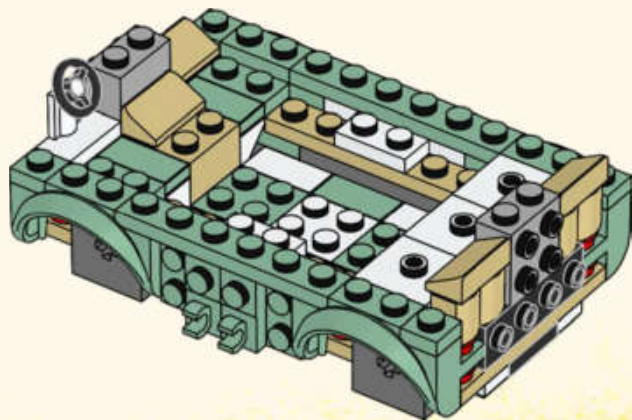



22

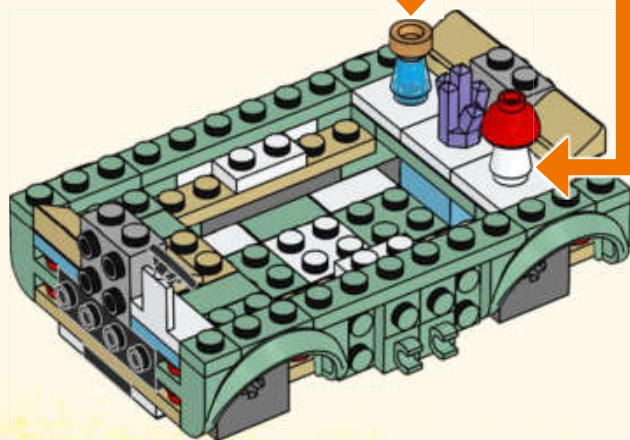





1

1

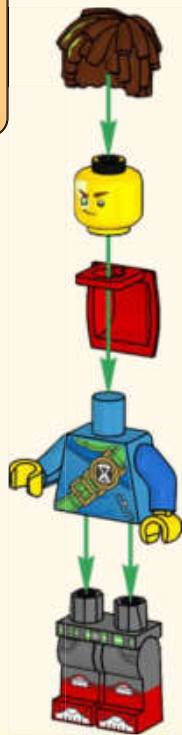



2

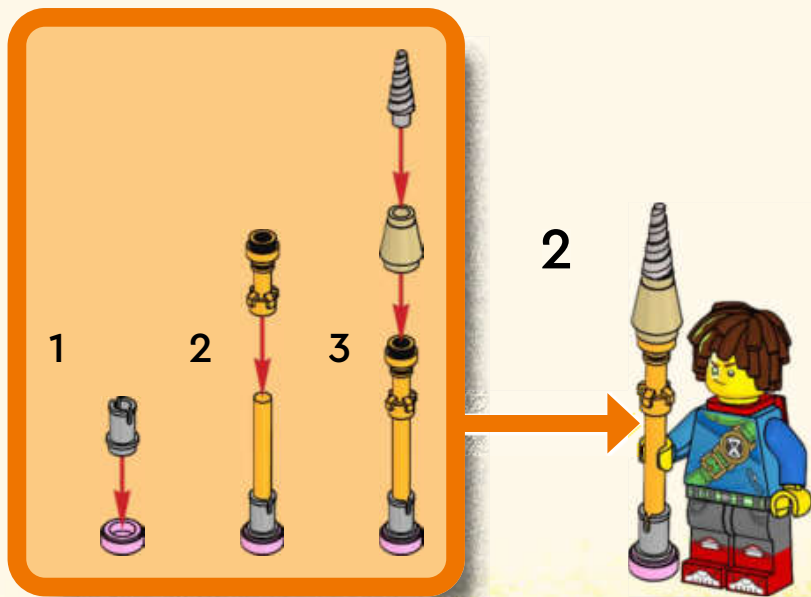



1x



1x



1x

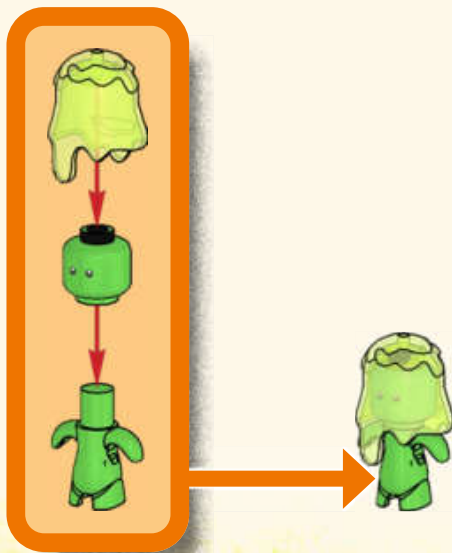





1x

23



1x

24





1x

25

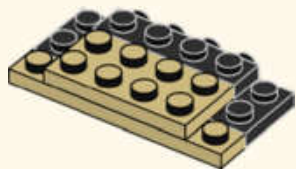

2x

26

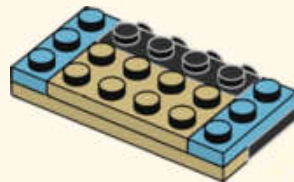



1x

27

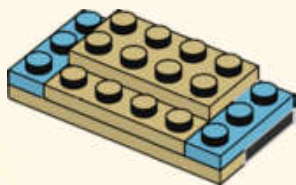

2x



4x

28

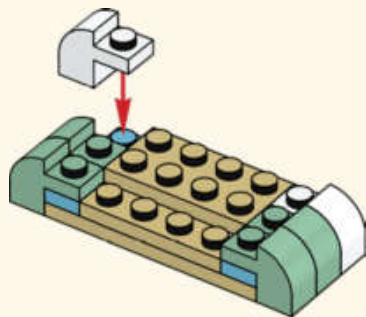



1x



2x

29

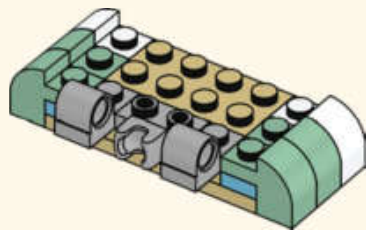

1x



1x

30

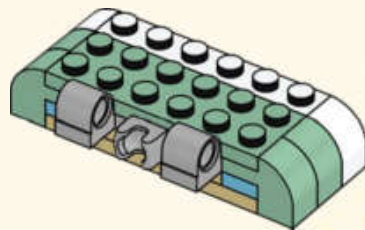



4x



1x

31

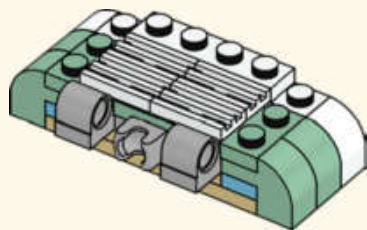



2x



2x



2x

32

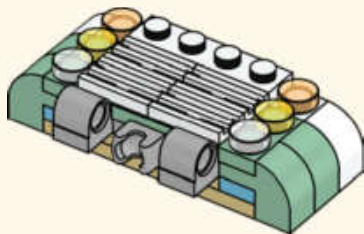

1x

33

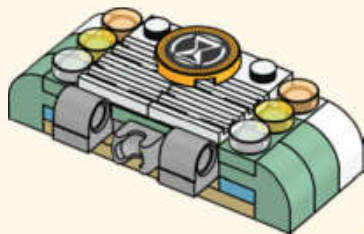



34

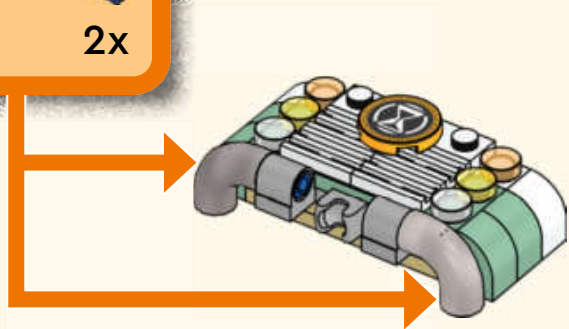
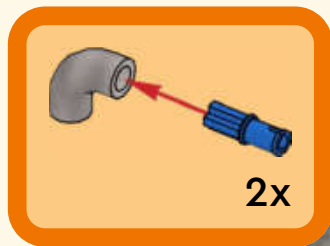

35

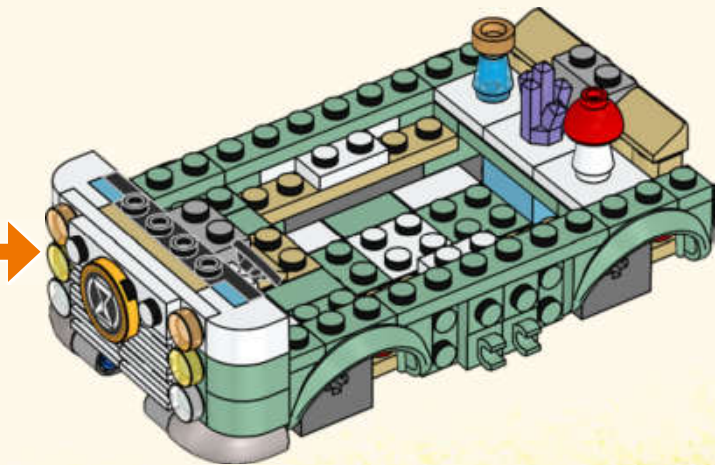



1x

36

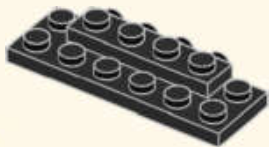

1x

37





1x

38

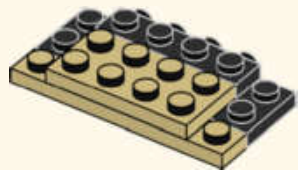

2x

39

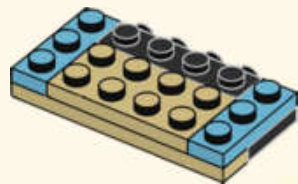



2x



1x

40

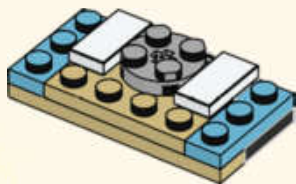

2x



4x

41

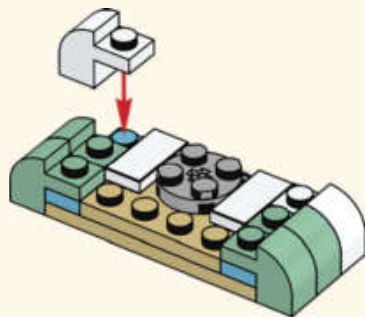



4x

42

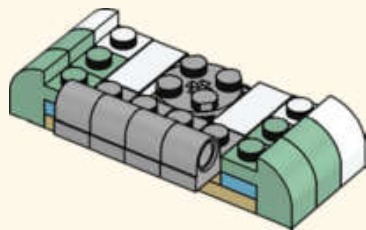

1x



1x

43

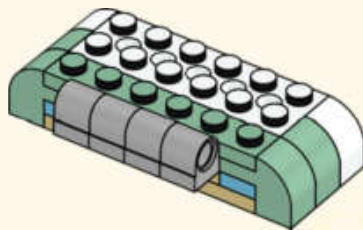



1x



1x

44

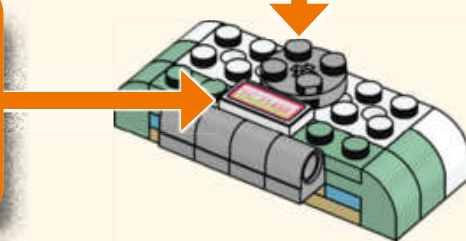
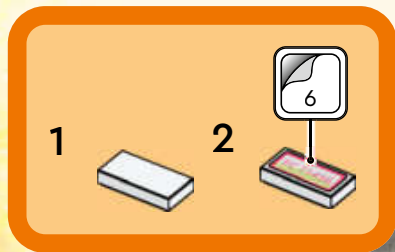



2x



2x

45

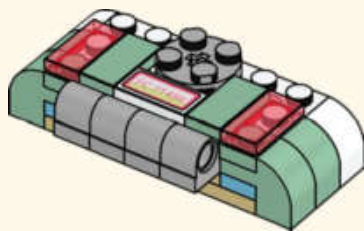



46

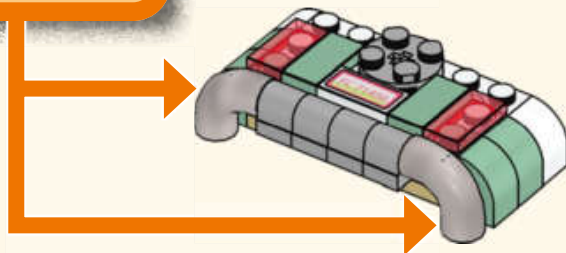
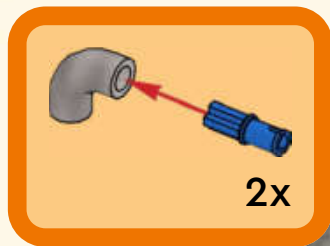

47

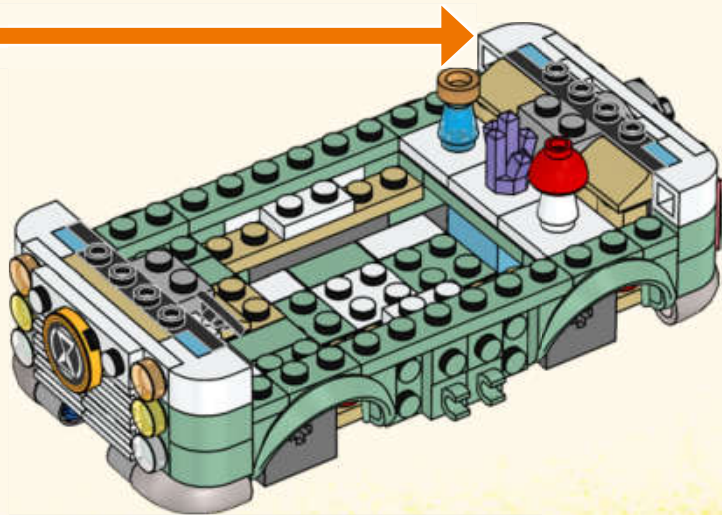







2x

48

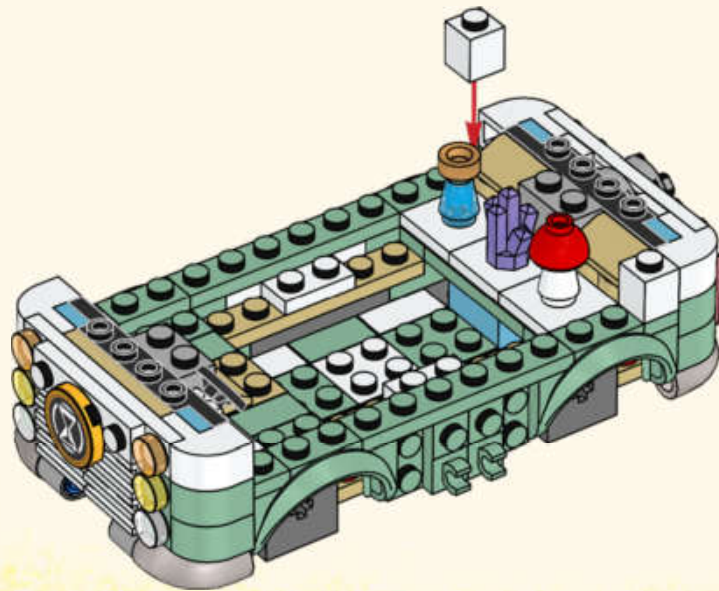

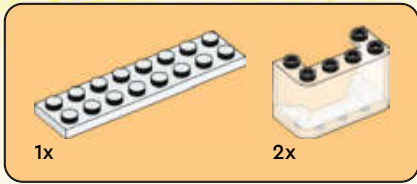

49

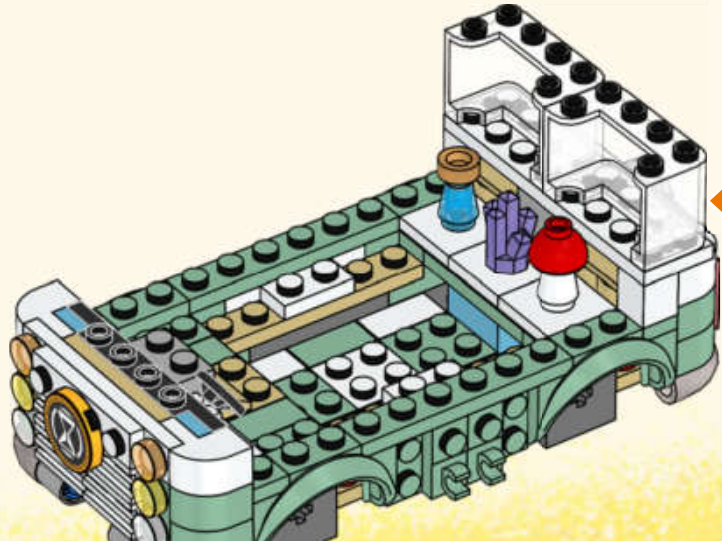
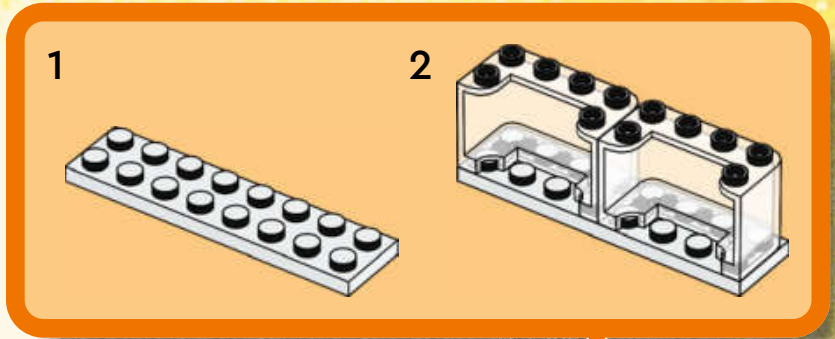



2x

50

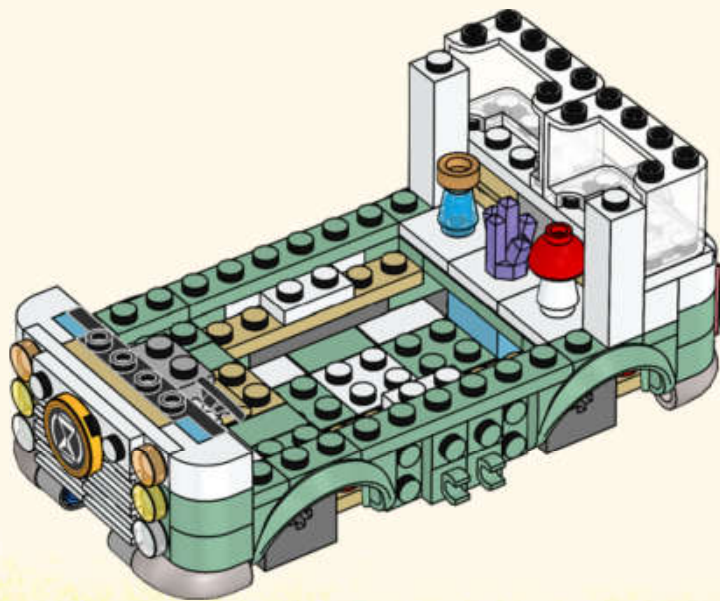

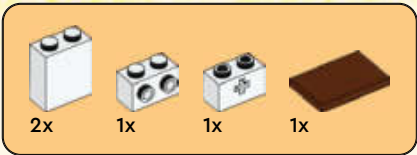

51

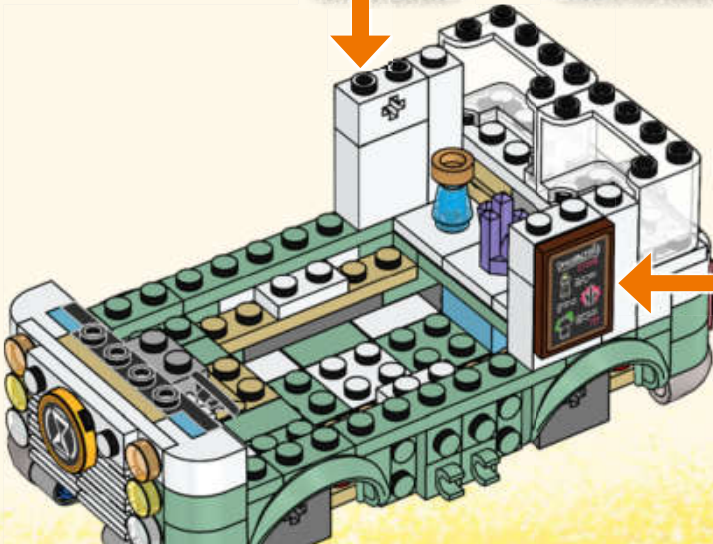
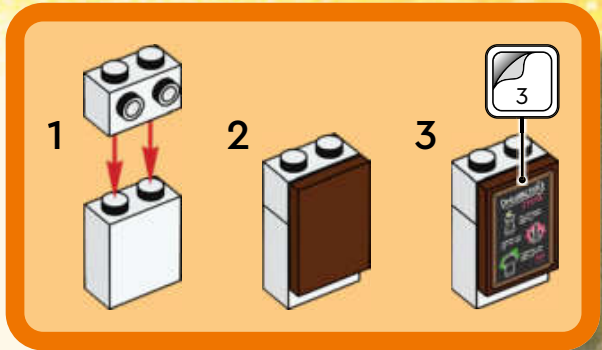
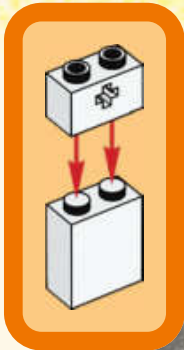

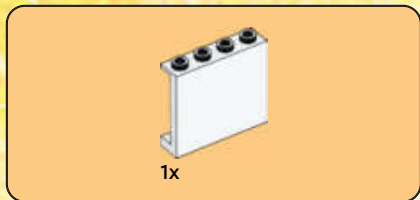

52

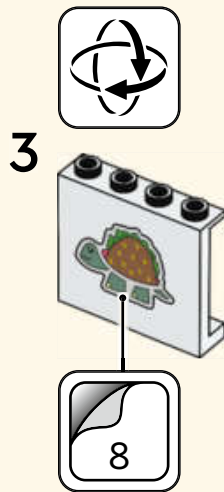
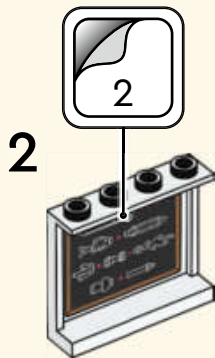

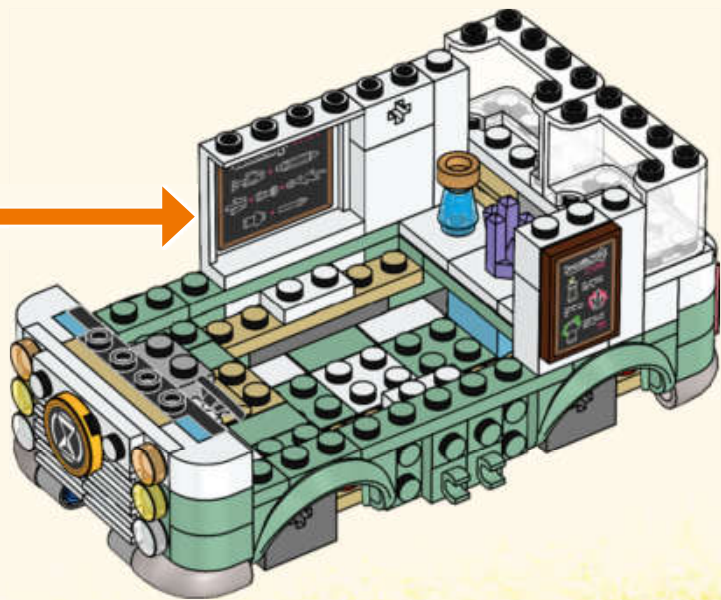

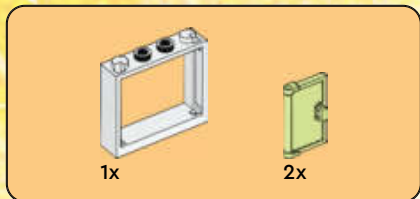

53

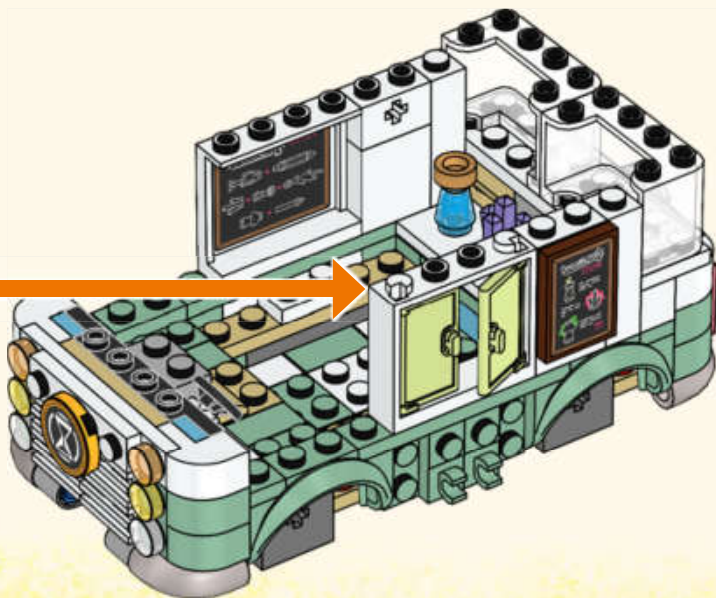
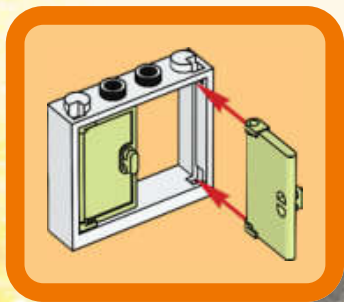

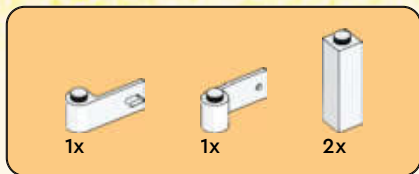

54

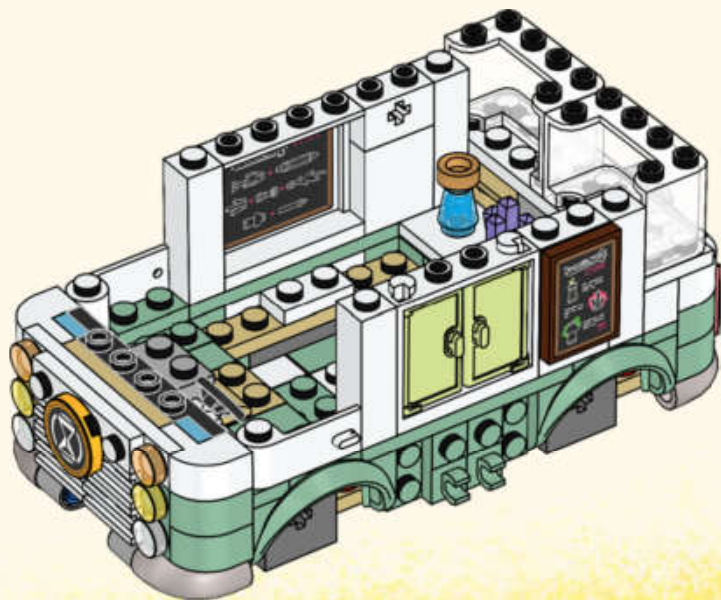

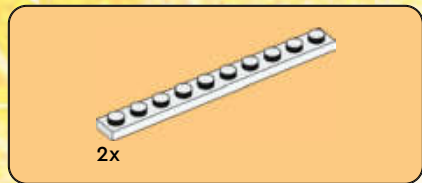

55

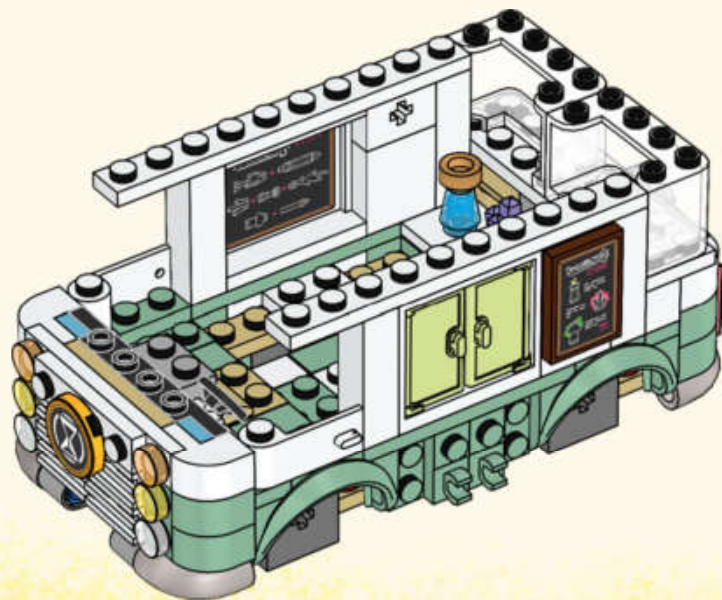



1x



2x

56

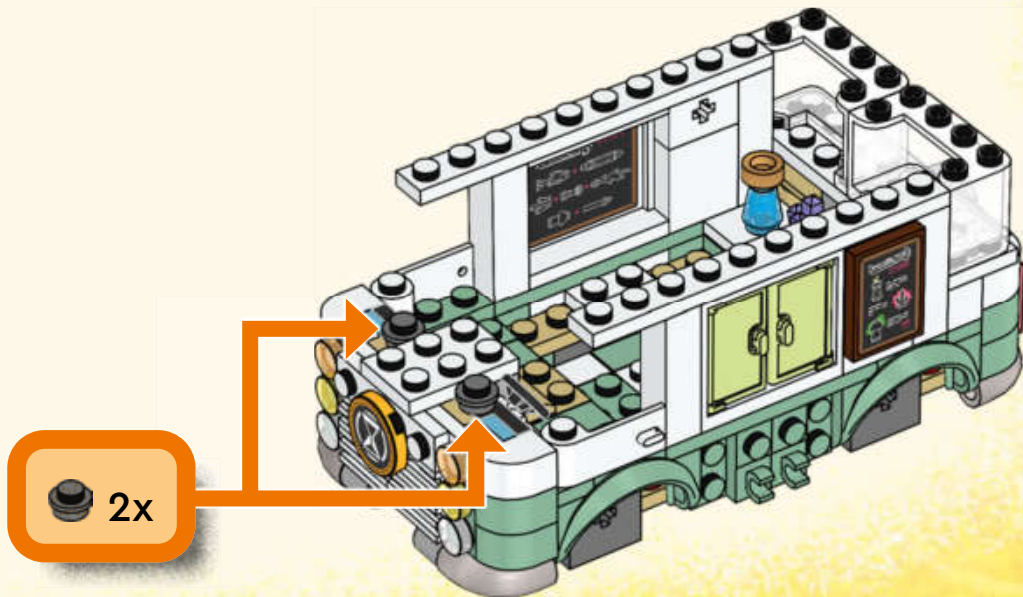

2x



2x

57

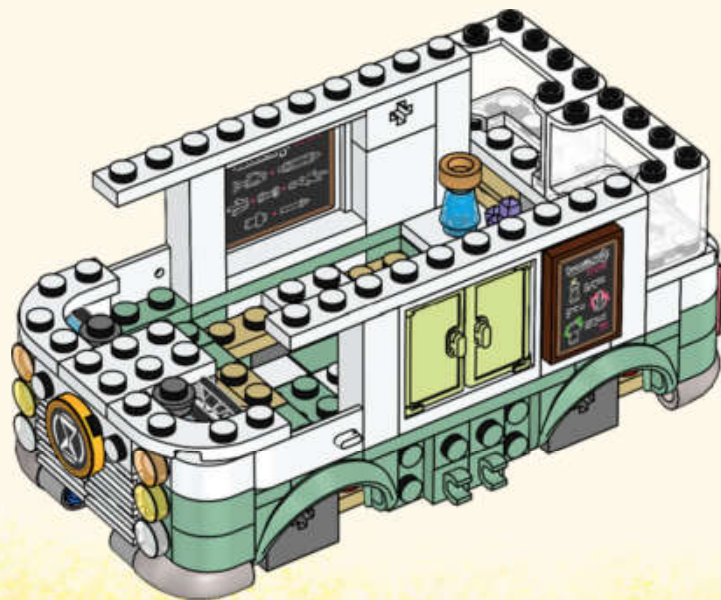



2x

58

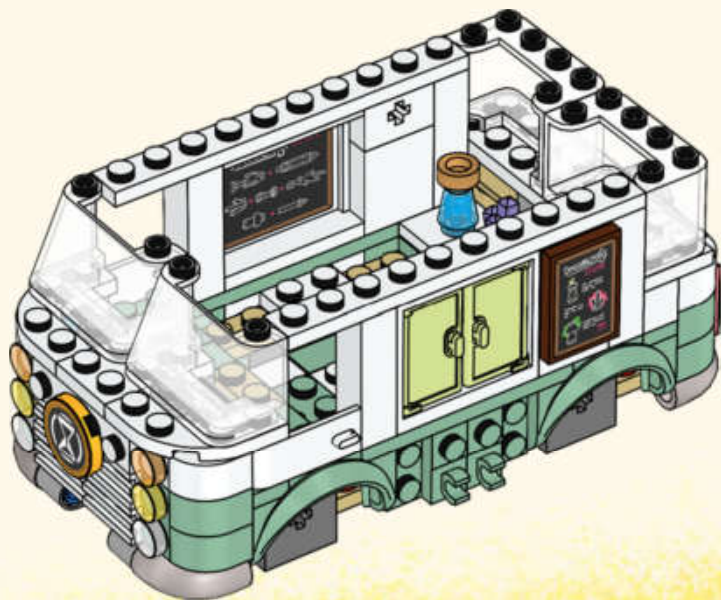



2x

59

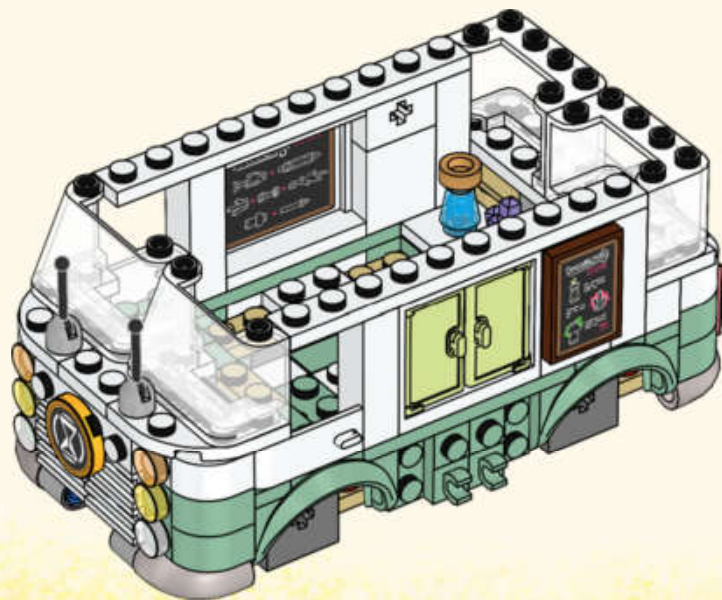

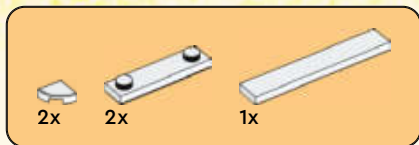

60

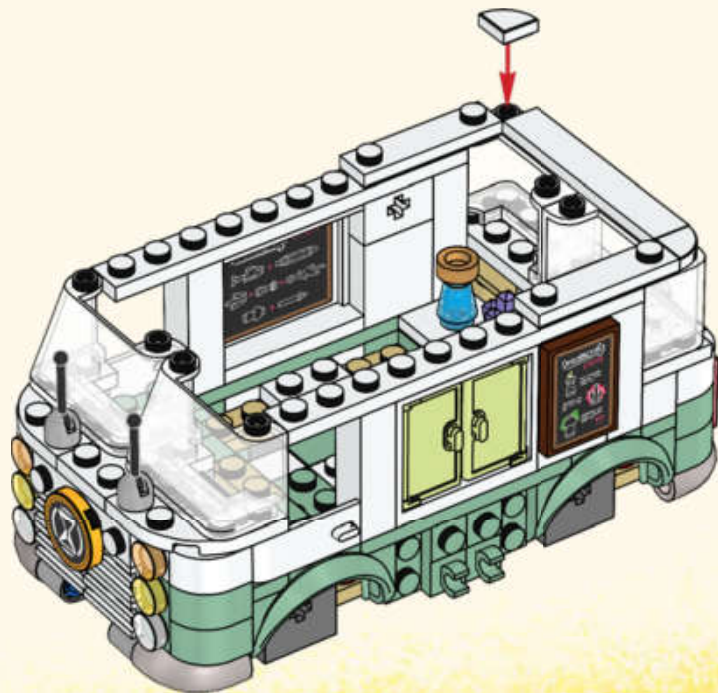



4x

61

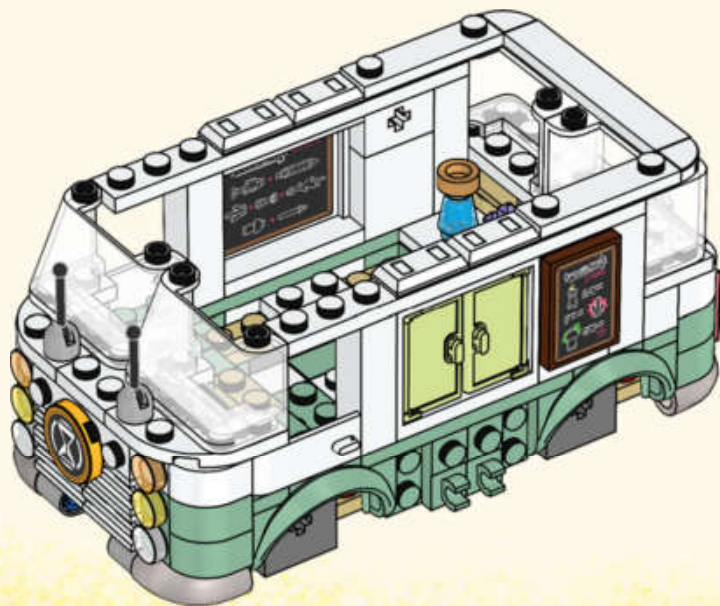

64

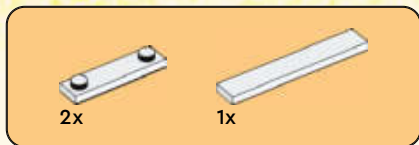

62

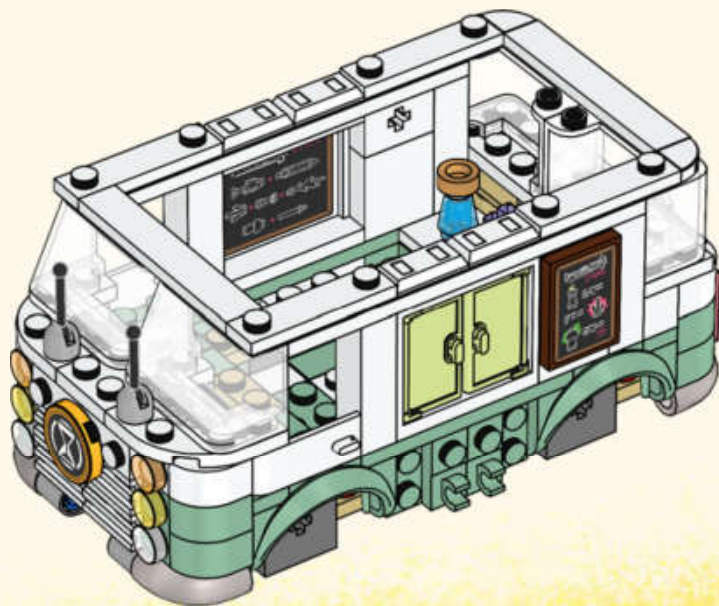



63

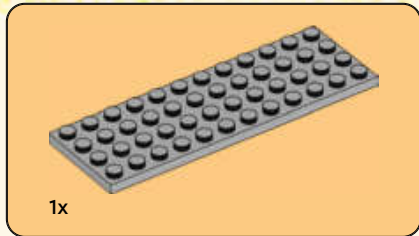

64

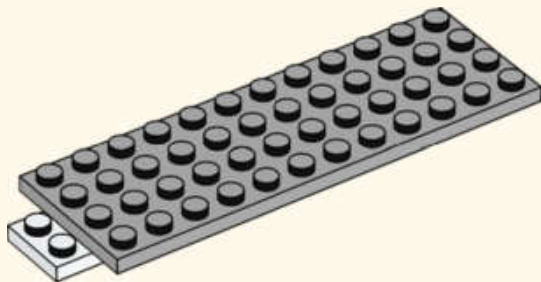



65

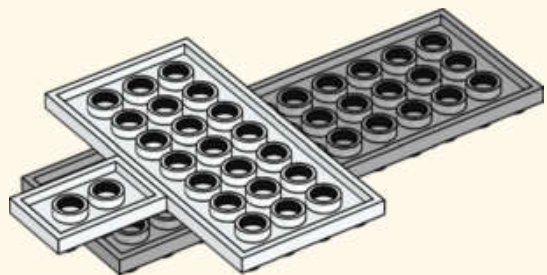

66

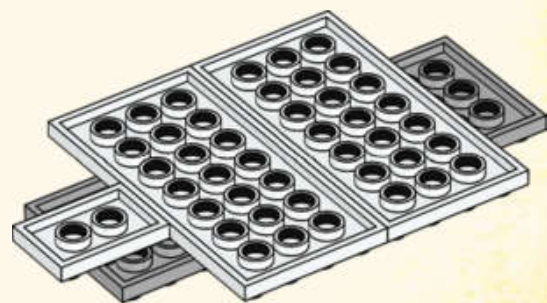



1x

67

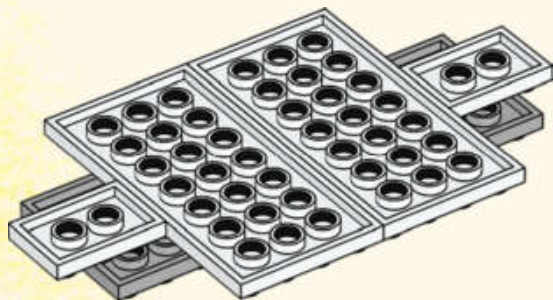

68



4x

68

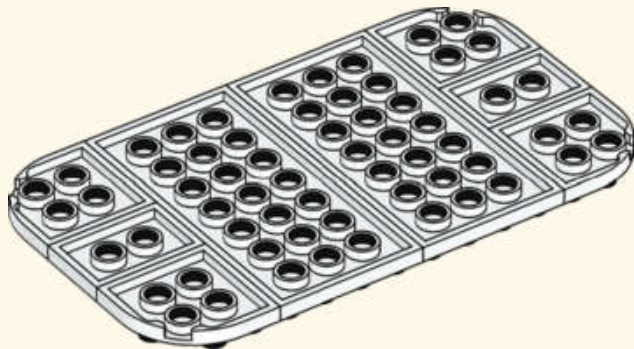



69

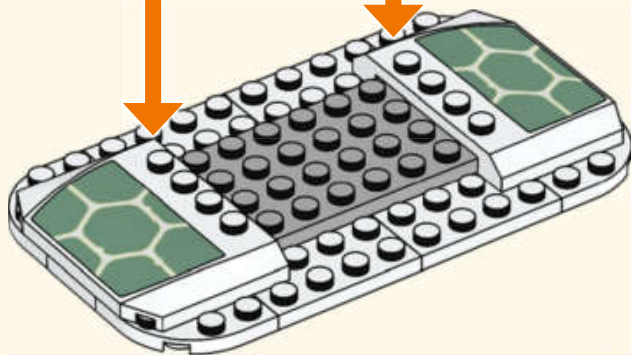
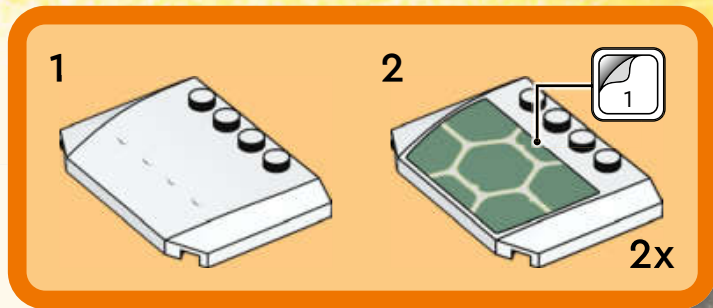



1x

70

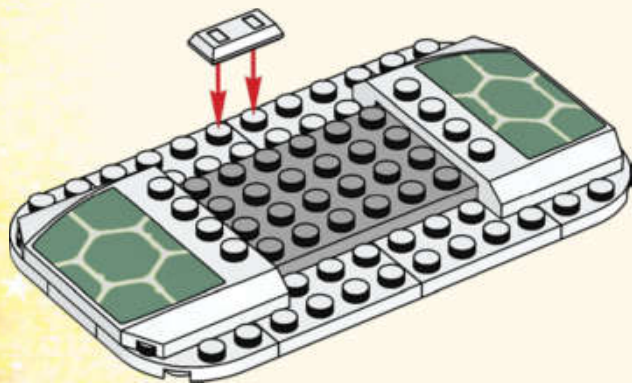

2x



2x

71

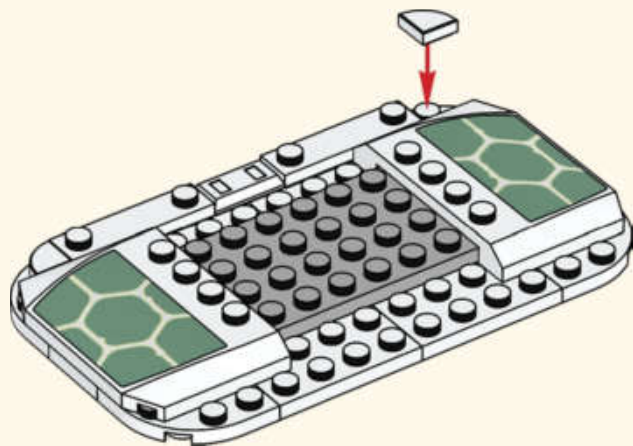



2x



1x

72

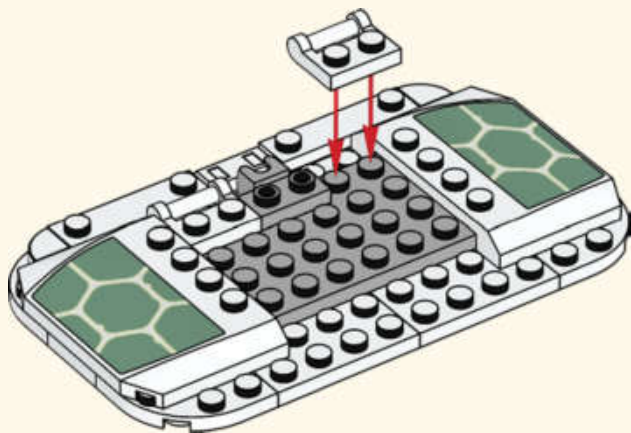

2x

73

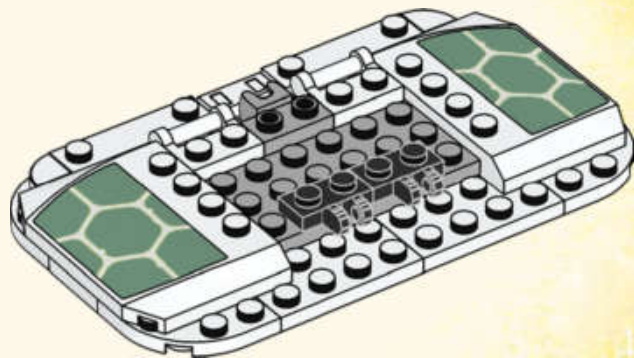

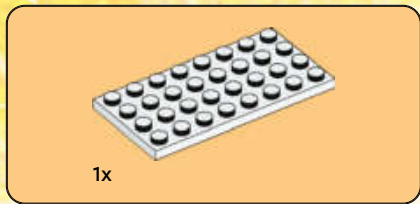

74

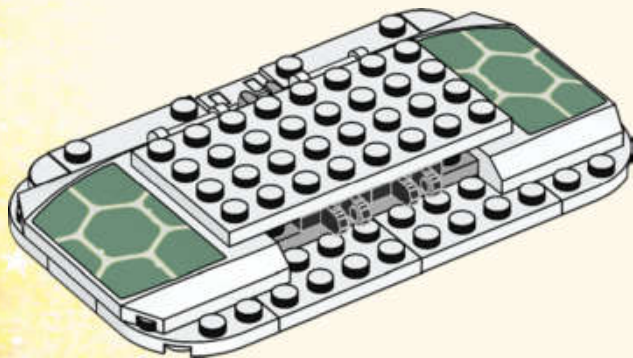

75

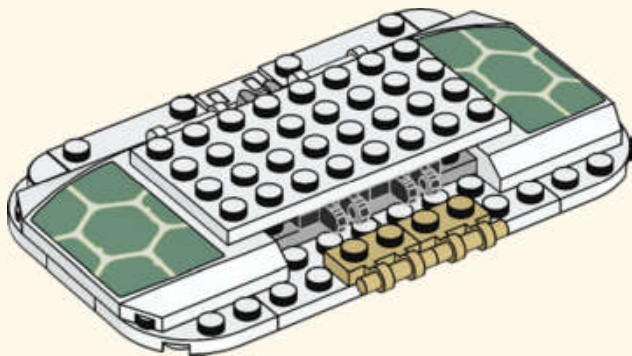



2x



1x

76

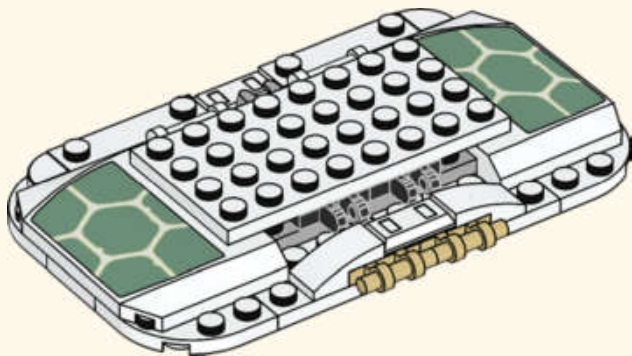

2x



2x

77

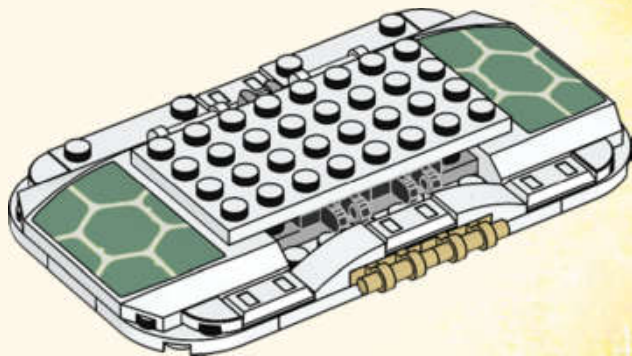



2x

78

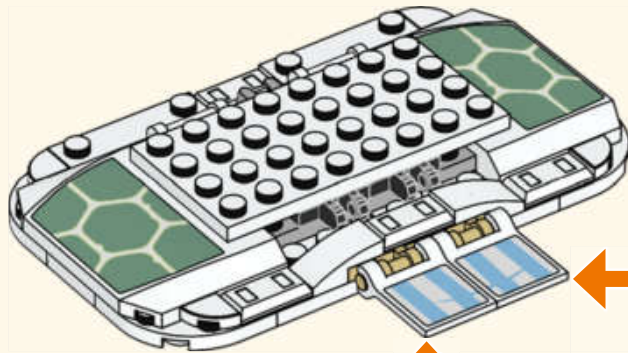

1



2



1



2

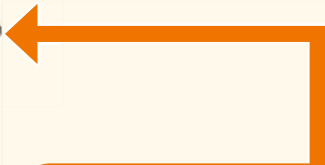

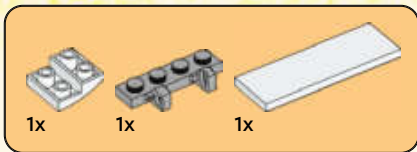

79

1



2



3

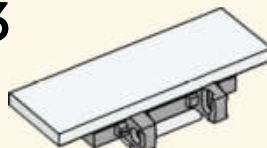

4

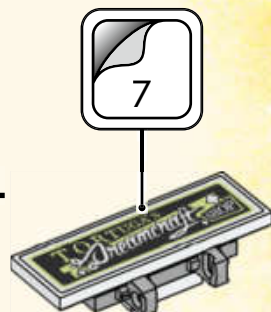

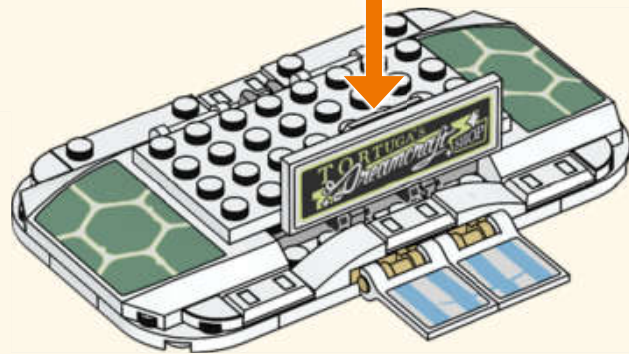

80

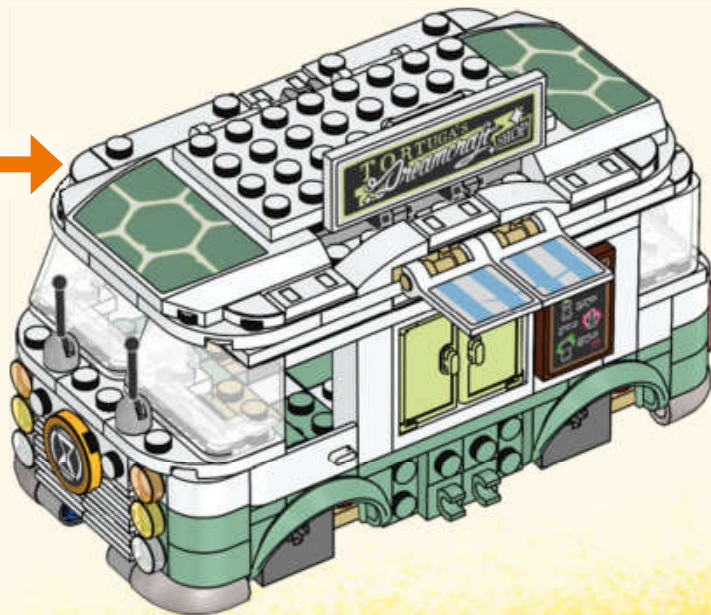



81

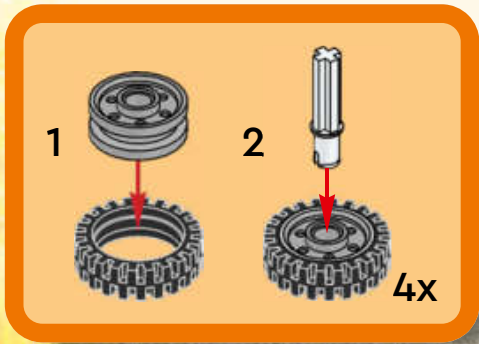
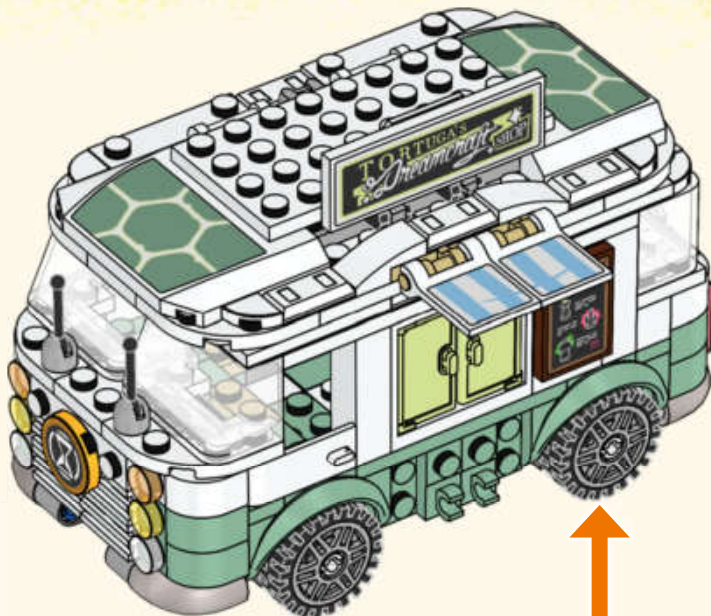



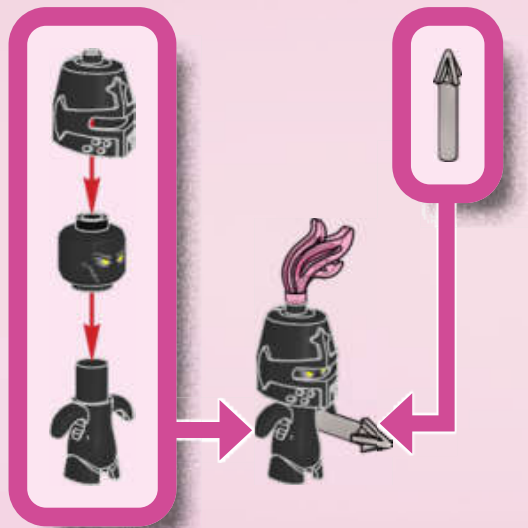





1x



1x



1x

1





1x



1x

2





3







1

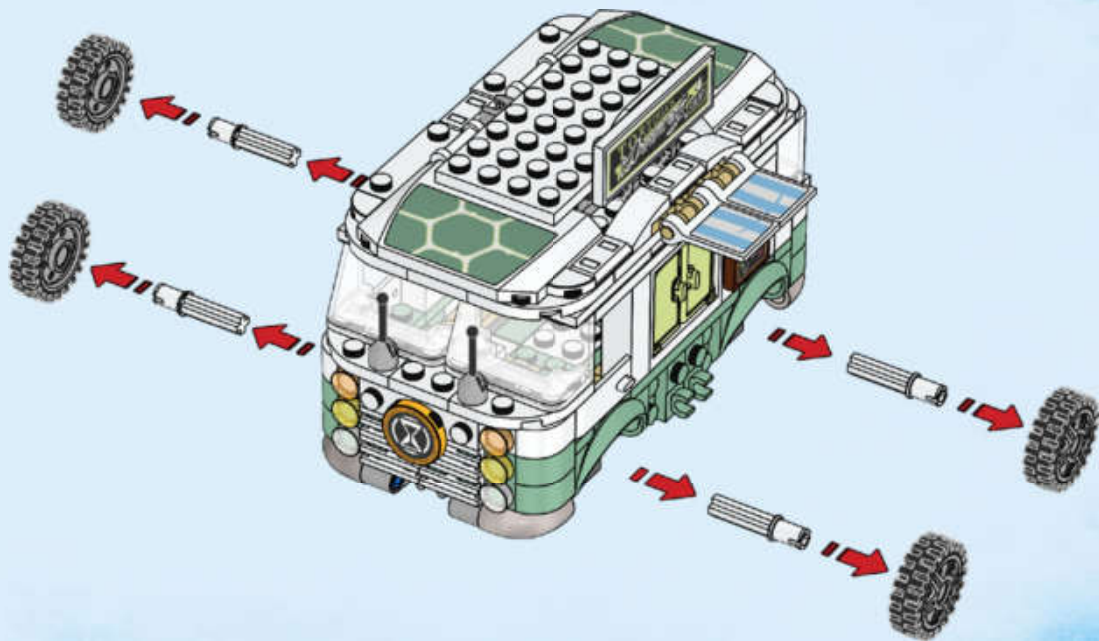



1x



1x



1x

2

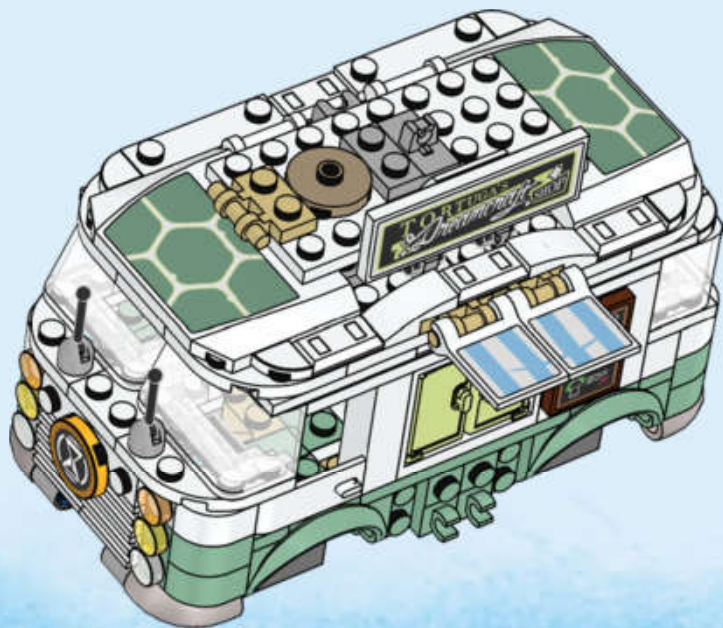

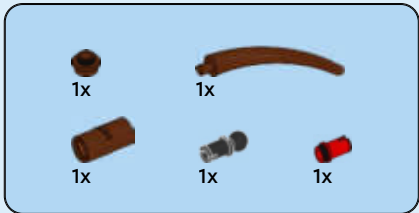
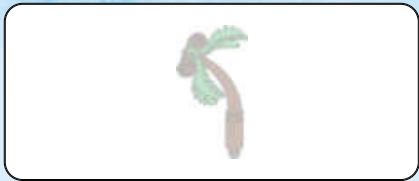

3

1



2



3





4

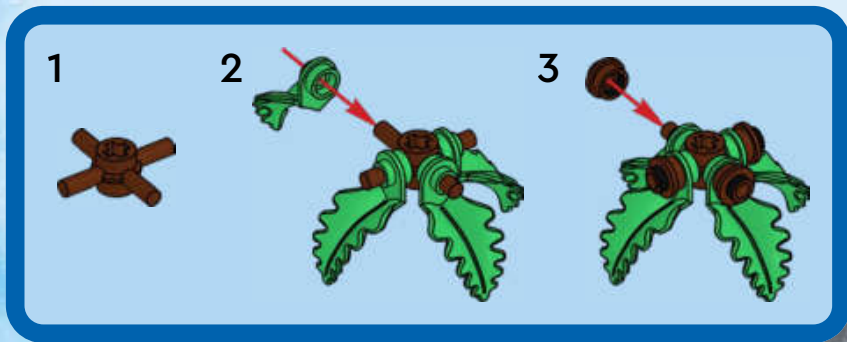

5

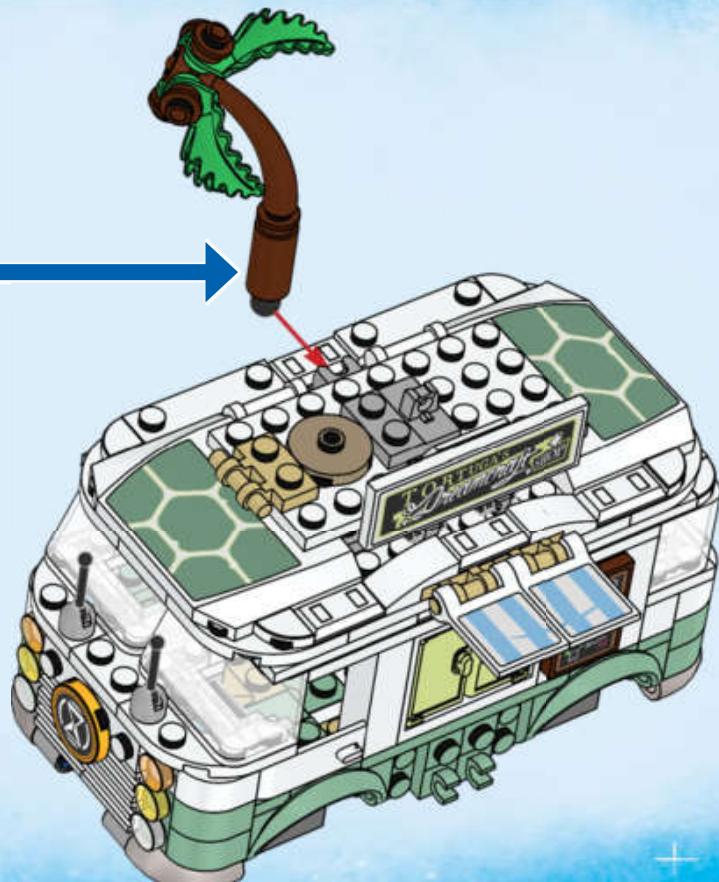



6

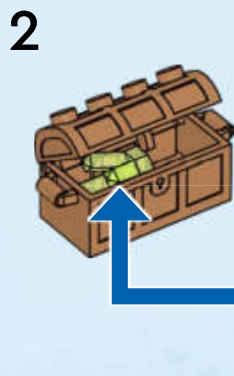
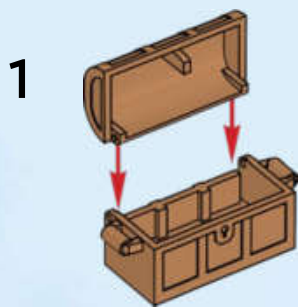

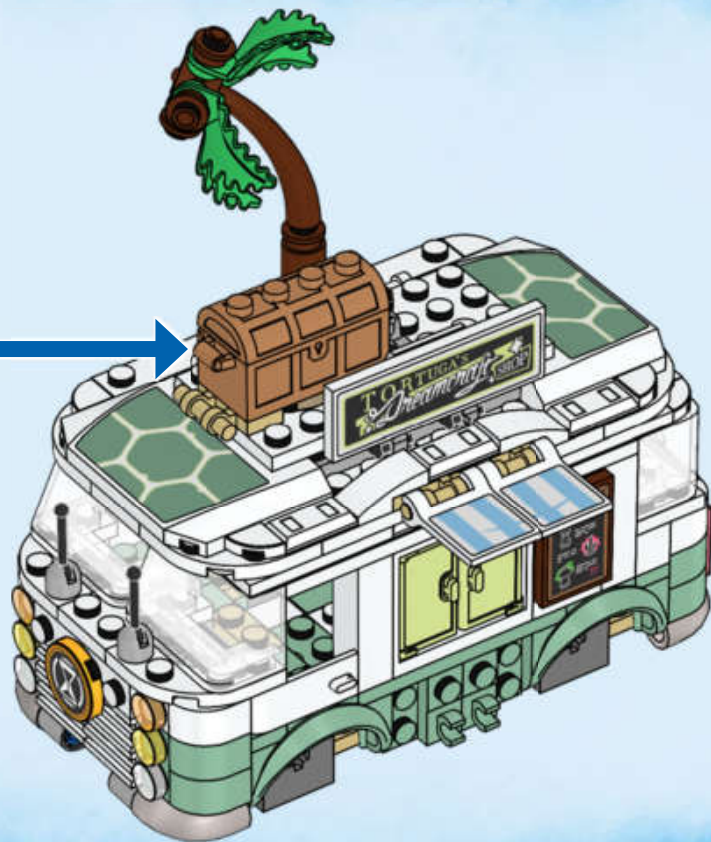

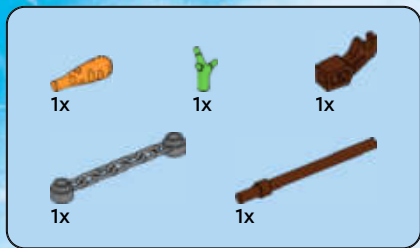

7

1



2



3



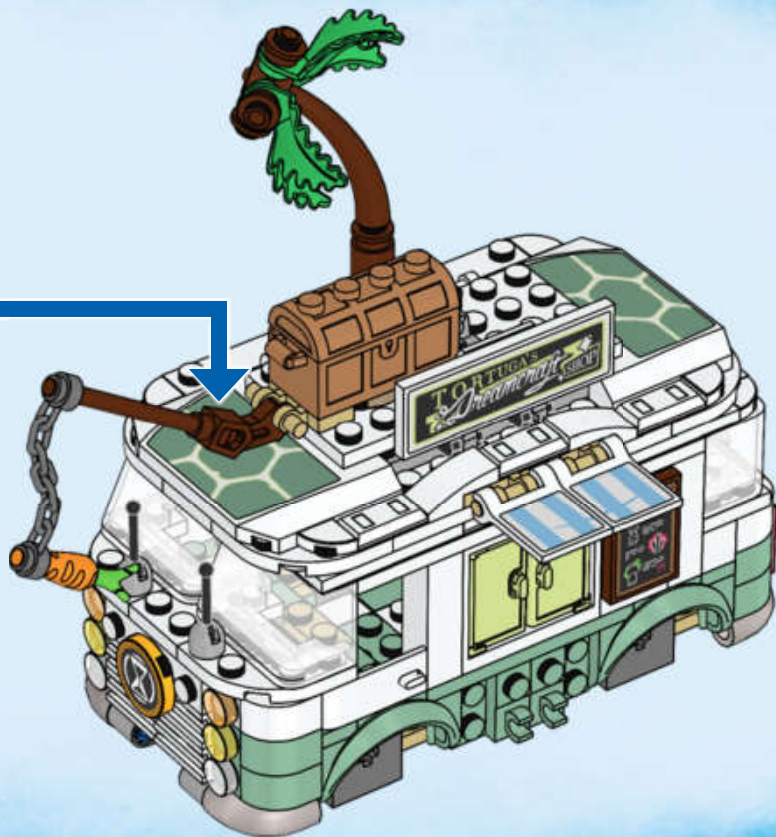



1x



1x

8

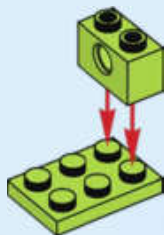

2x

9

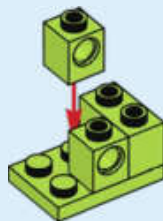



1x

10



1x



2x

11

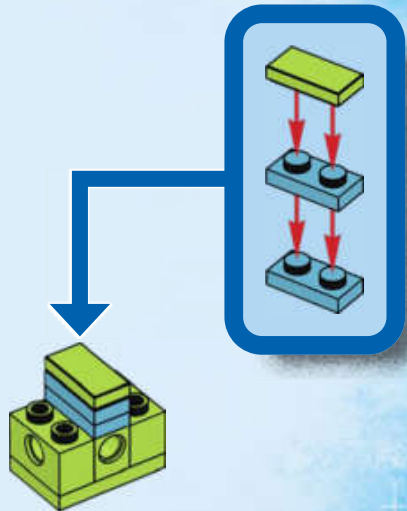



2x

12

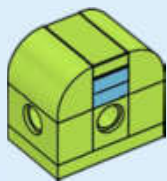



1x

13

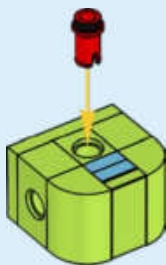

1x

14





1x

15

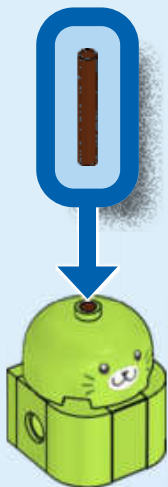

1x

16



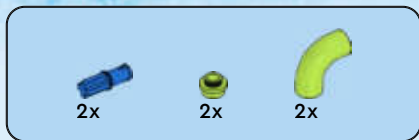

17

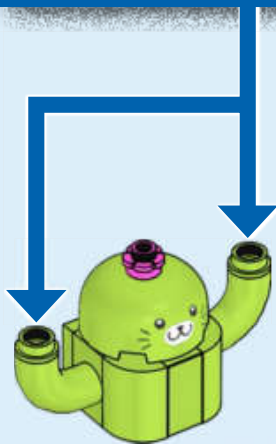
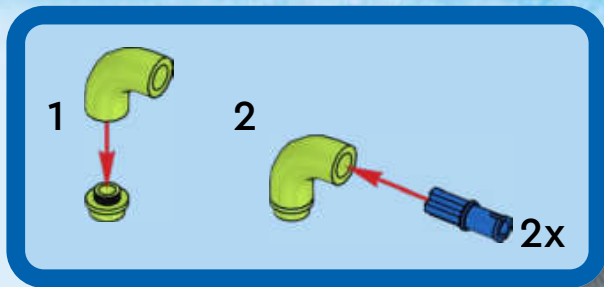



18

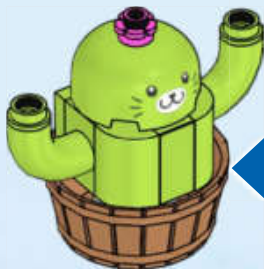
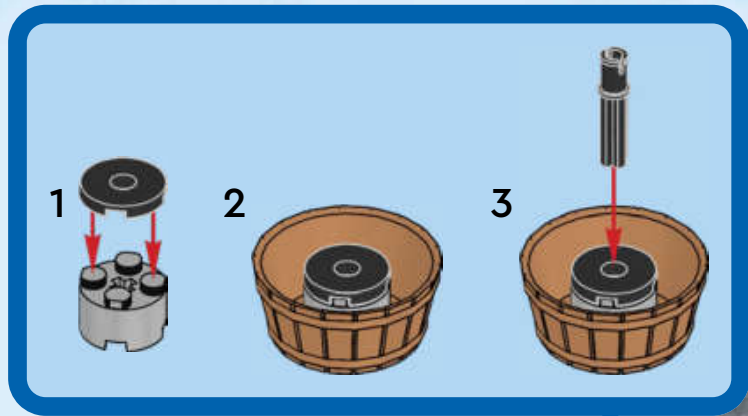

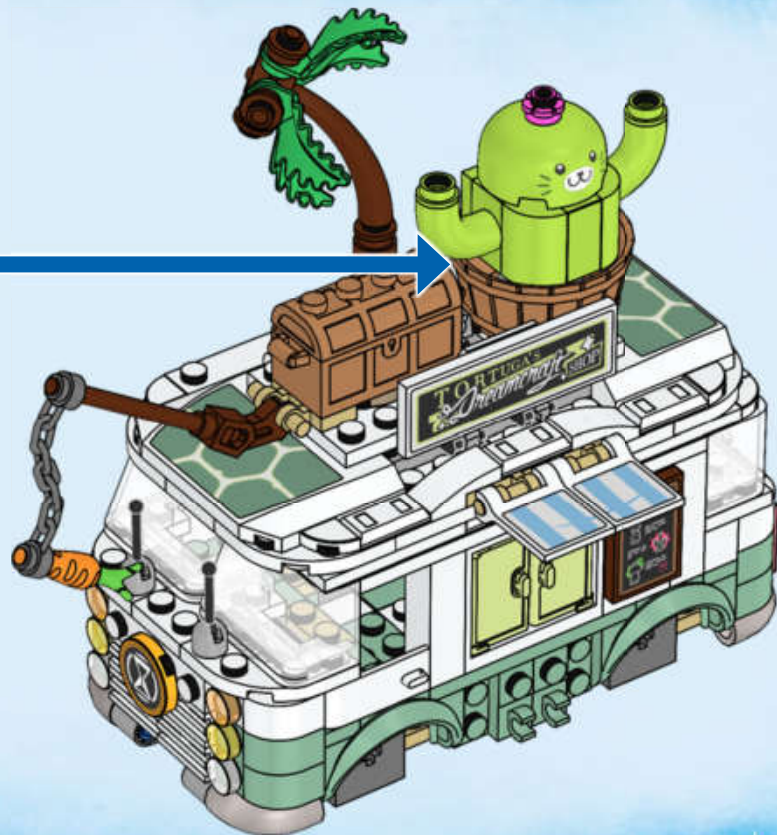



20

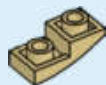

21



22





1x

23



1x



4x

24

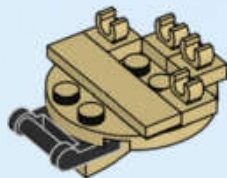

1x



1x

25





26

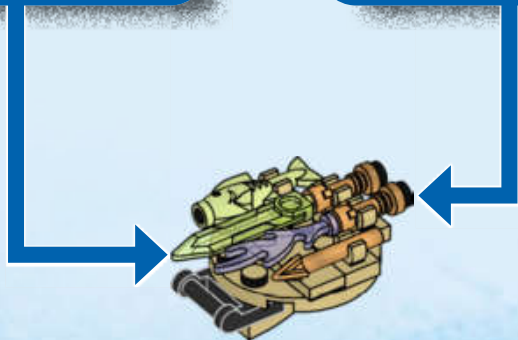
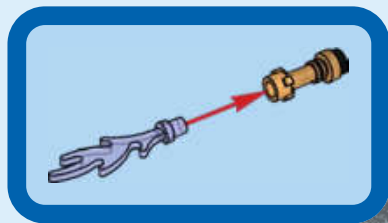
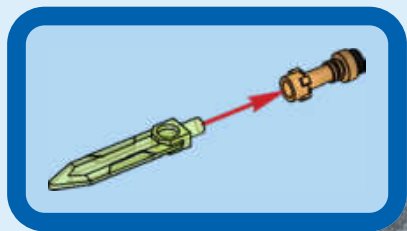

27

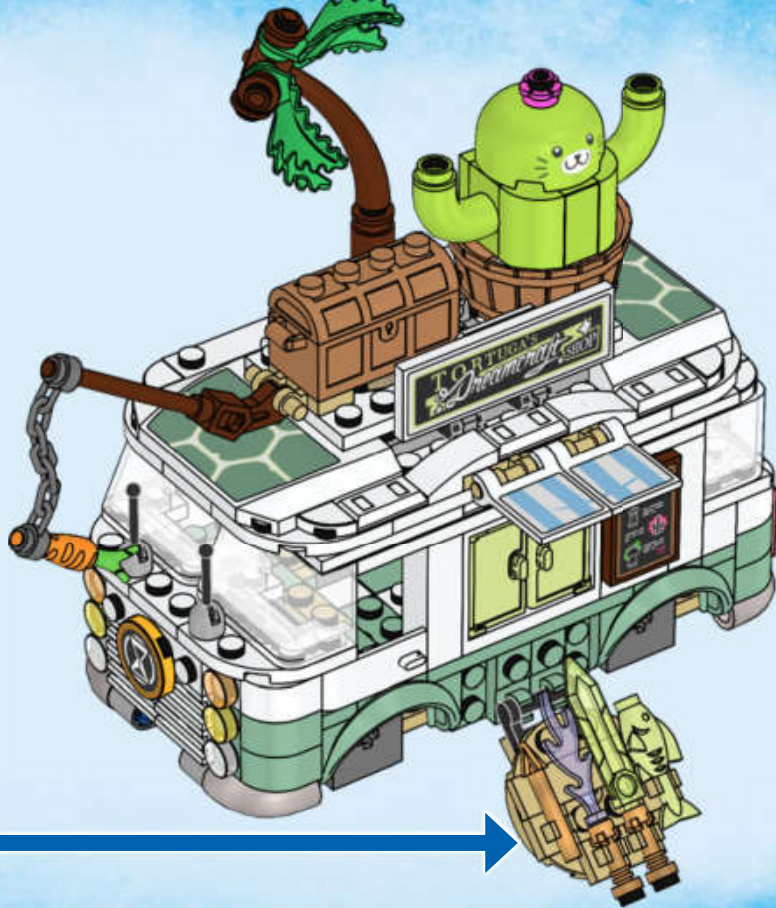



28

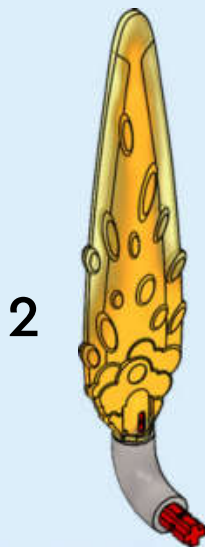
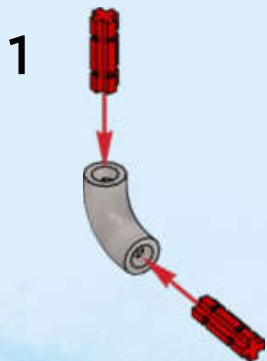

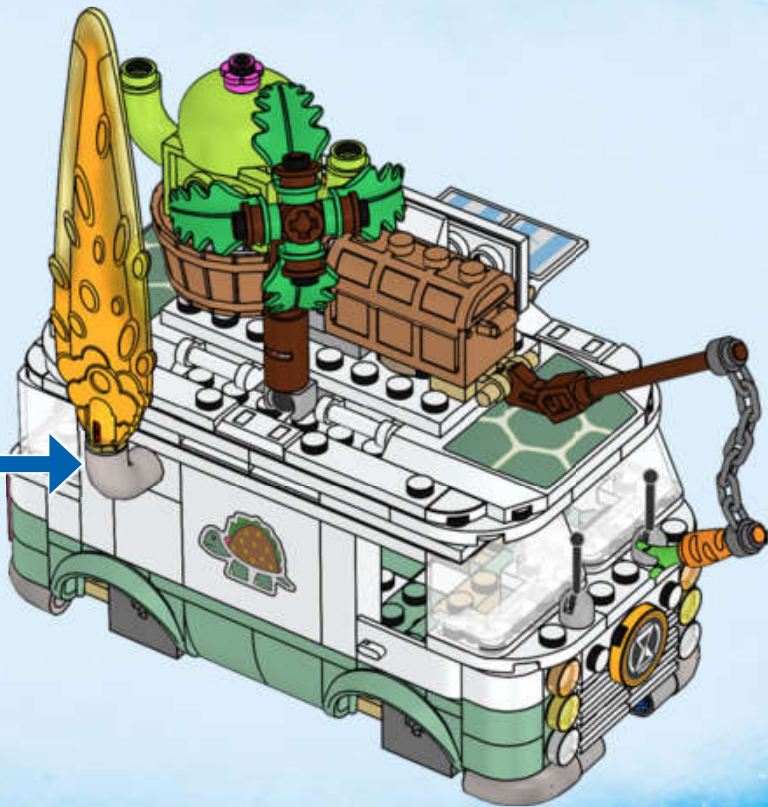
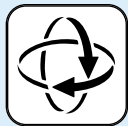





29

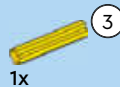

30

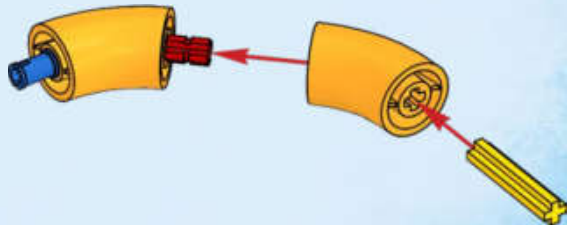

31

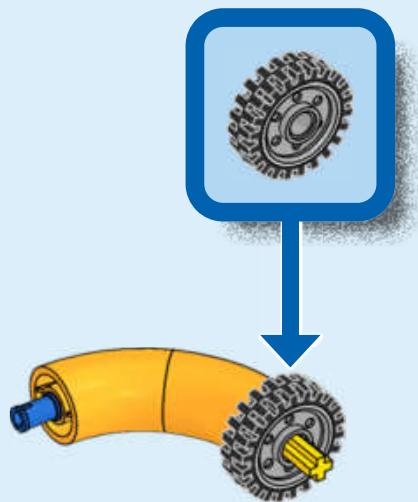

4x

32

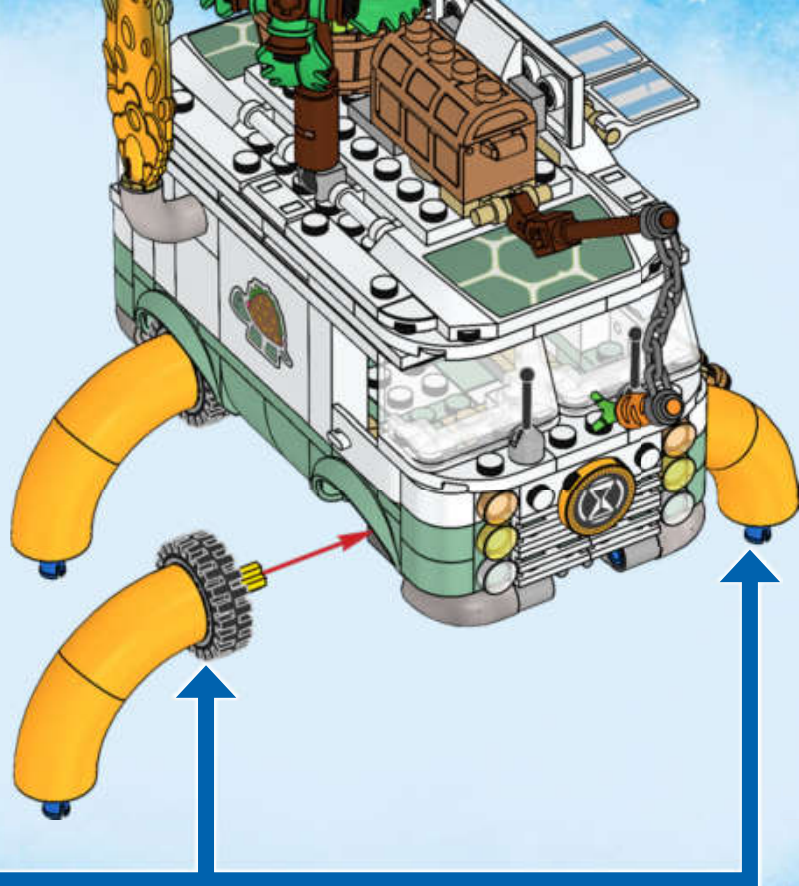



2x



2x



2x



2x



2x



6x

33

1



2

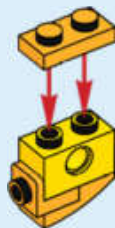

3



2x

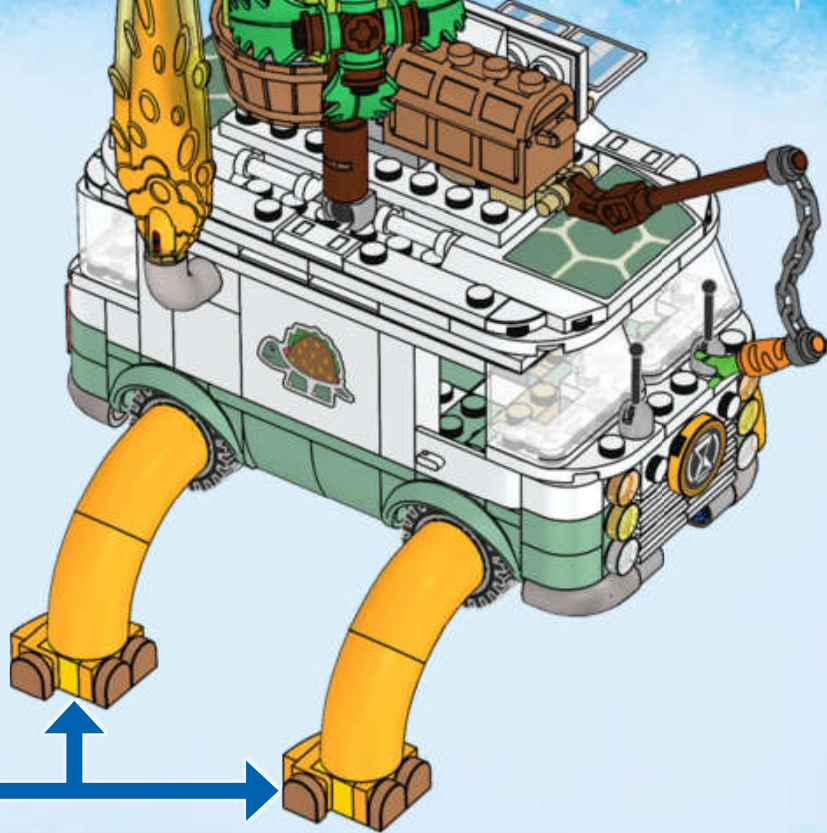



2x



2x



2x



2x



2x



6x

34

1



2

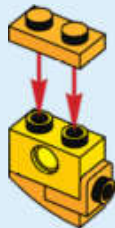

3



2x

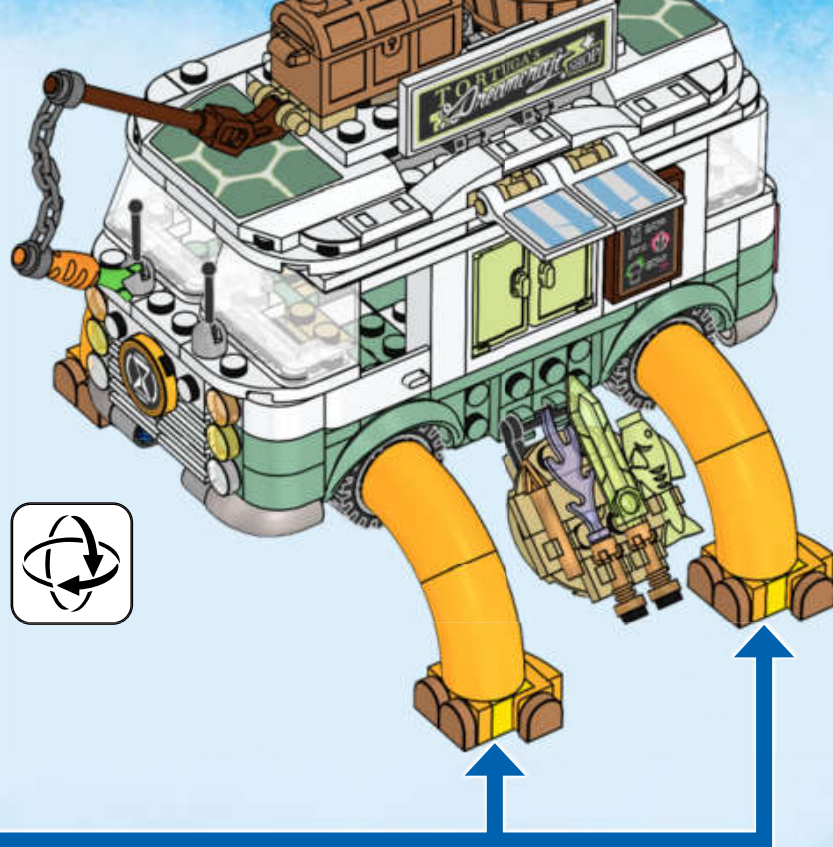



1x

35



2x

36

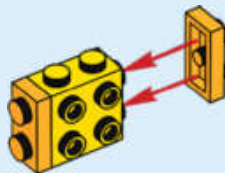



37



38





2x



1x

39

1



2





2x

40



1x



1x

41

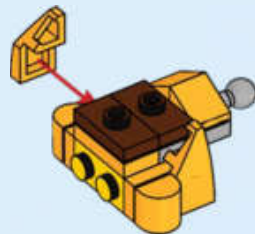



1x

42





43

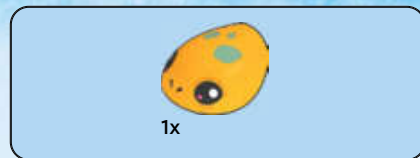

44

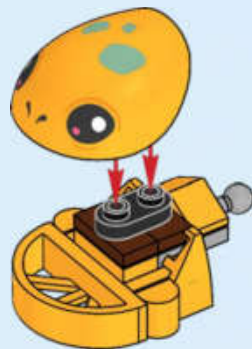

45

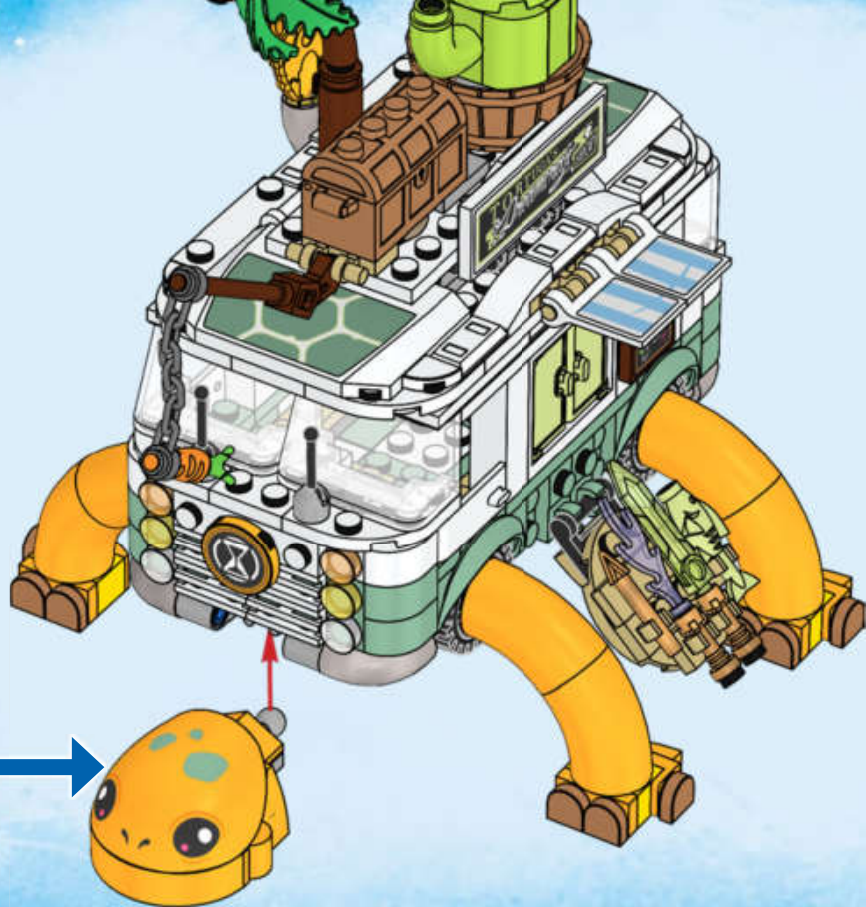



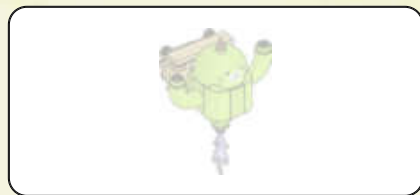

1x



1x

1





2x

2

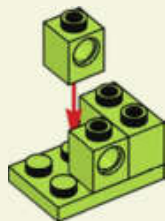

1x

3





1x



2x

4

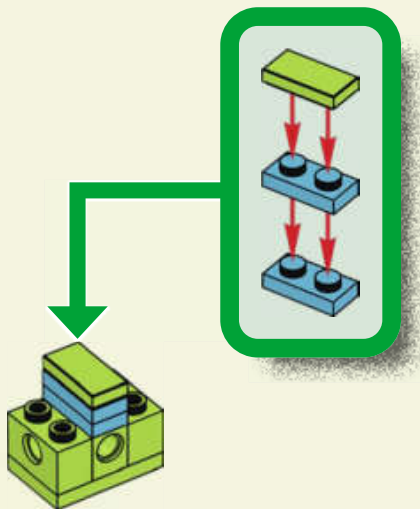



2x

5

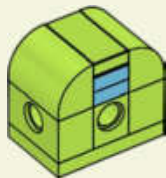

1x

6

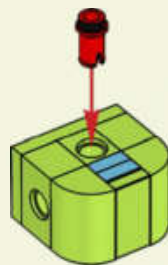



1x

7



1x

8

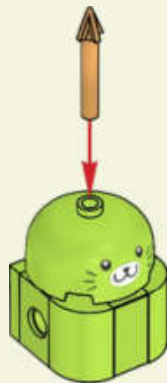

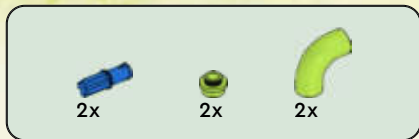

9

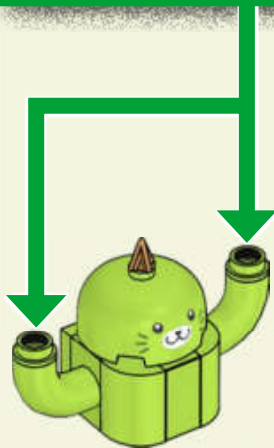
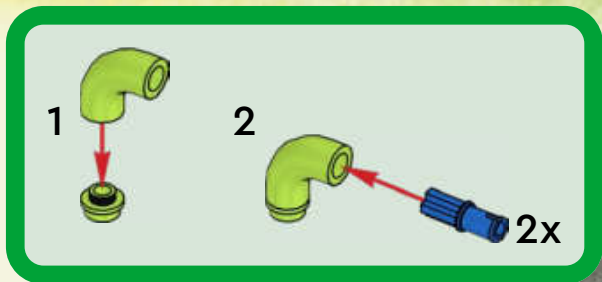



10



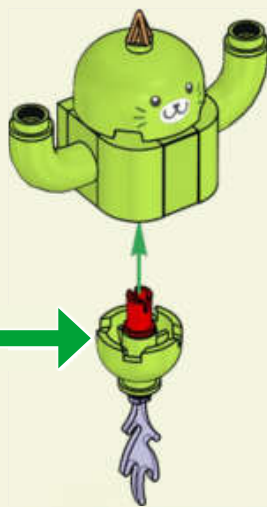



1x



1x

11

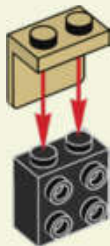

1x

12





4x



2x



2x

13

1

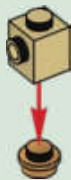

2



3



2x

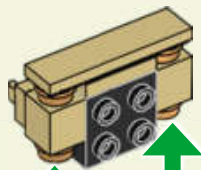



2x

14

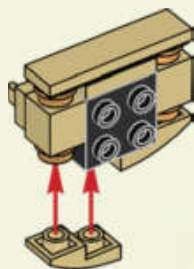

2x

15

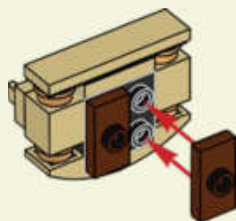



1x

16

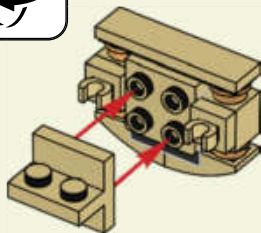

2x

17

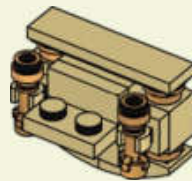

18

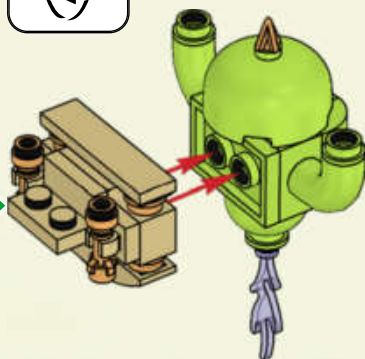



1

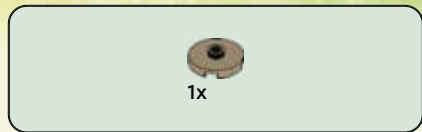

2

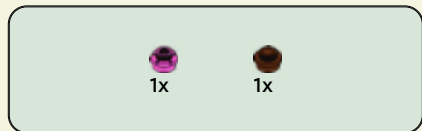

3



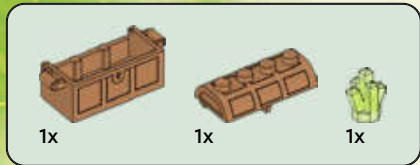

4

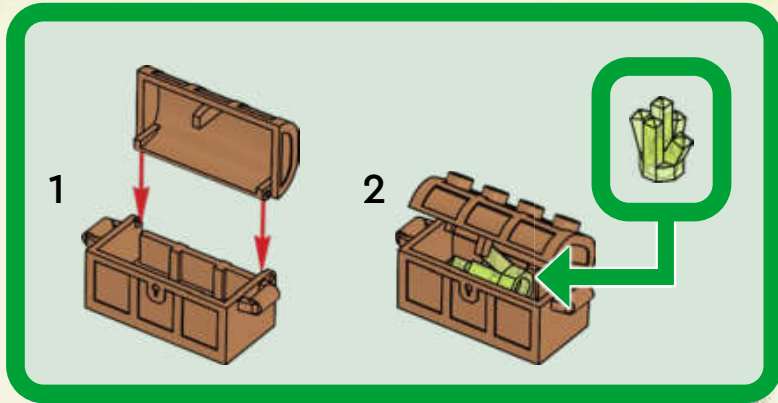



1x



1x

5

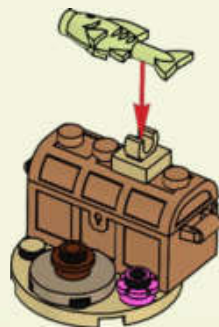



1x

6



4x

7





4x

8



1x

9



10



1

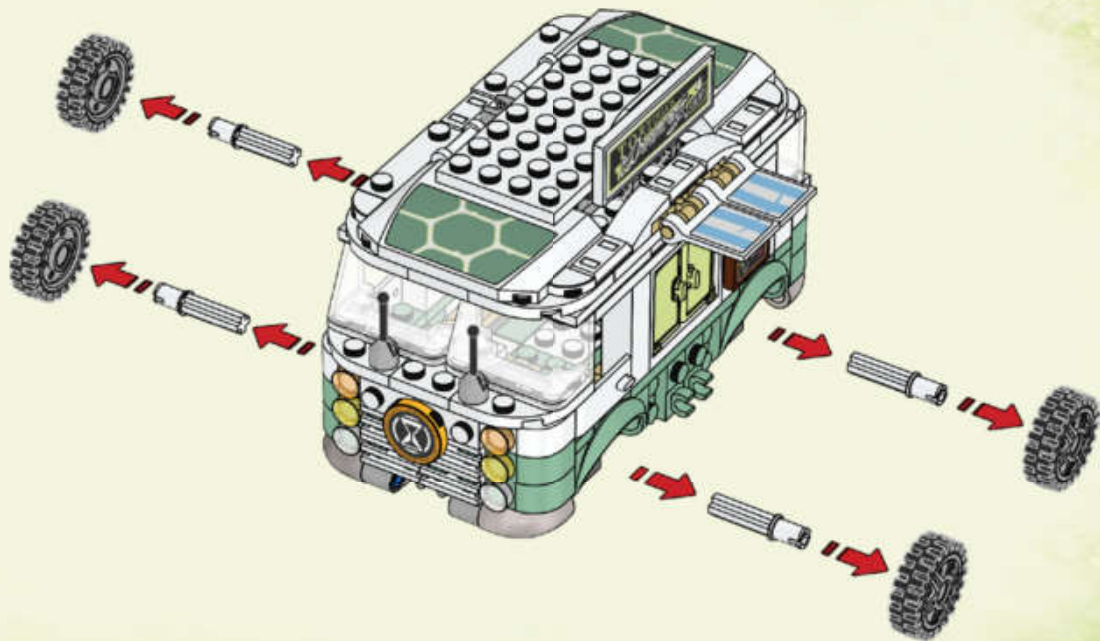

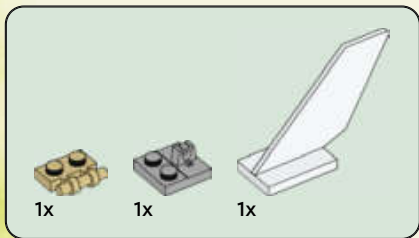

2

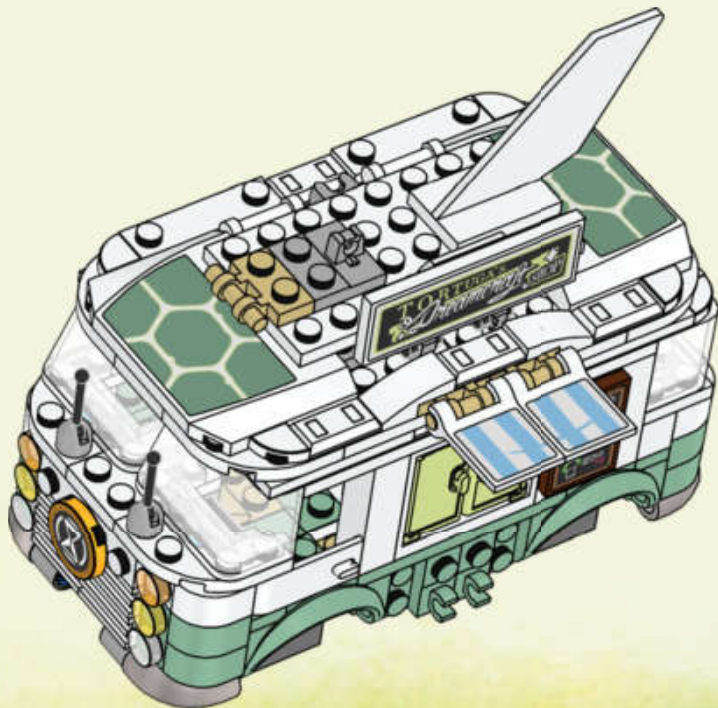



3

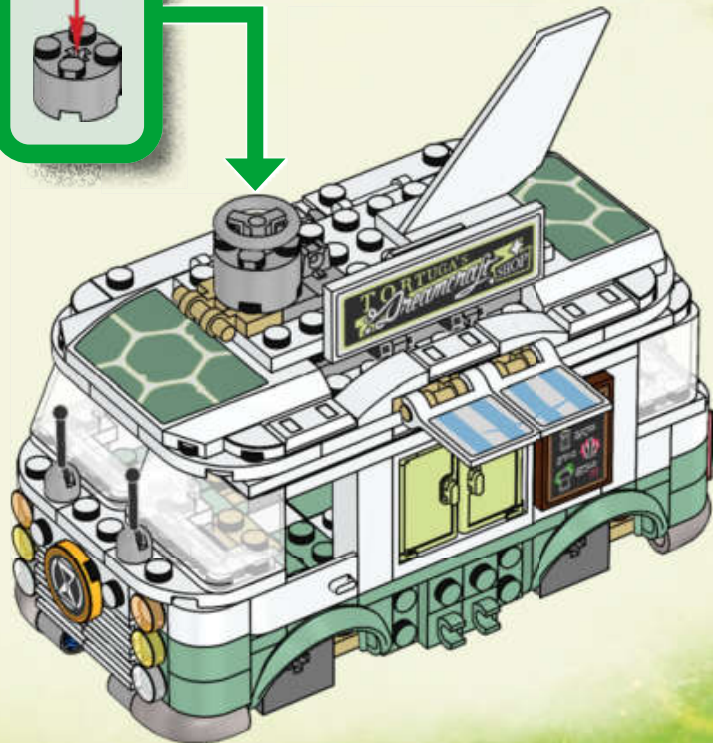
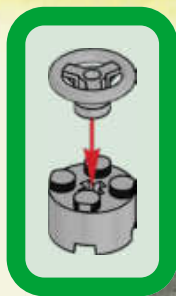



4

1



2



3

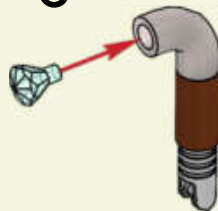

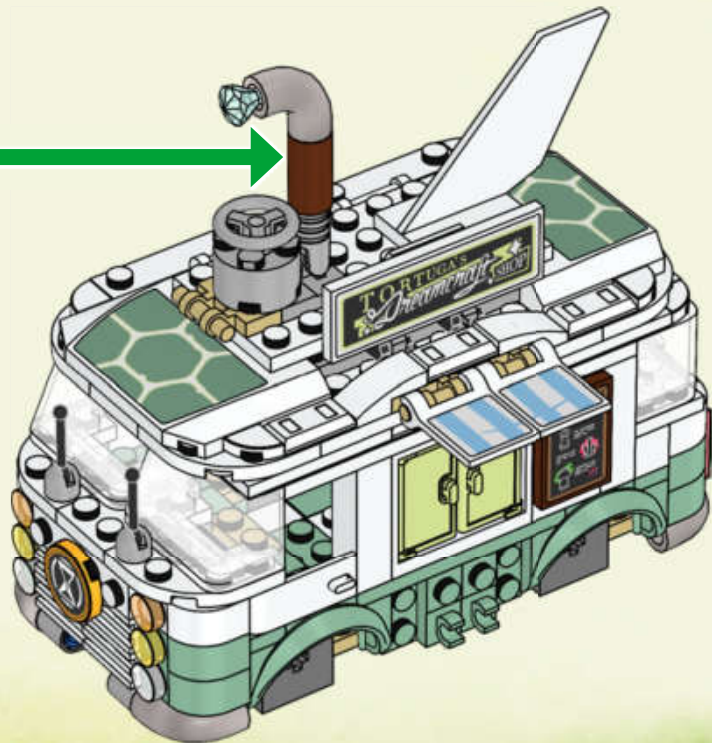



5

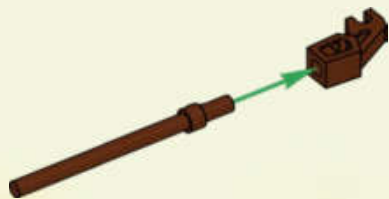

6





2x

7

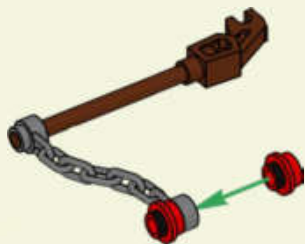

1x



1x

8

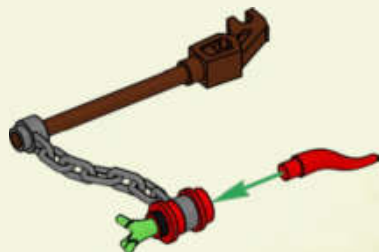

9

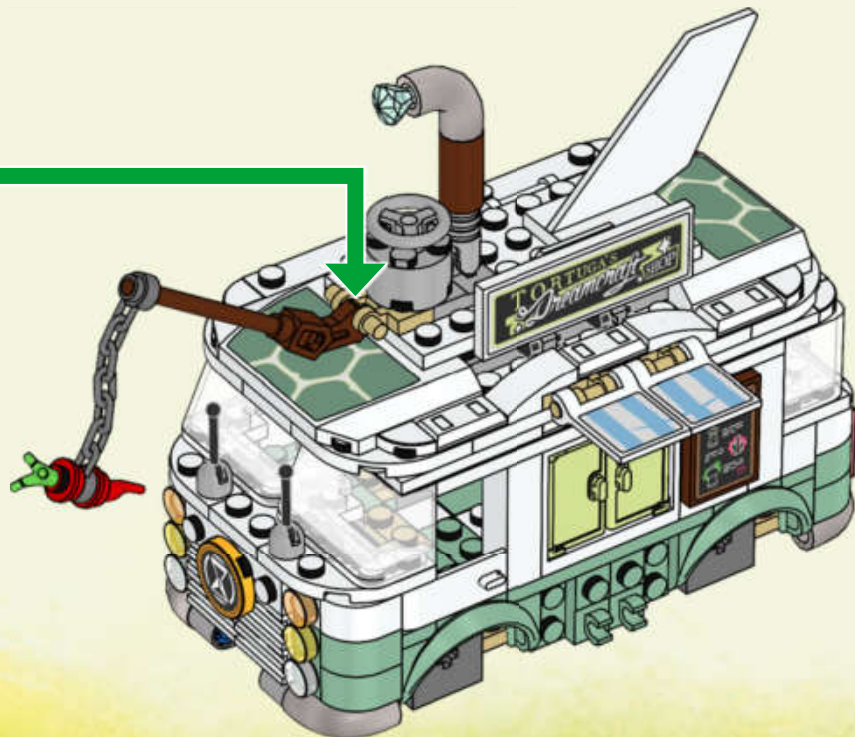



1x

10

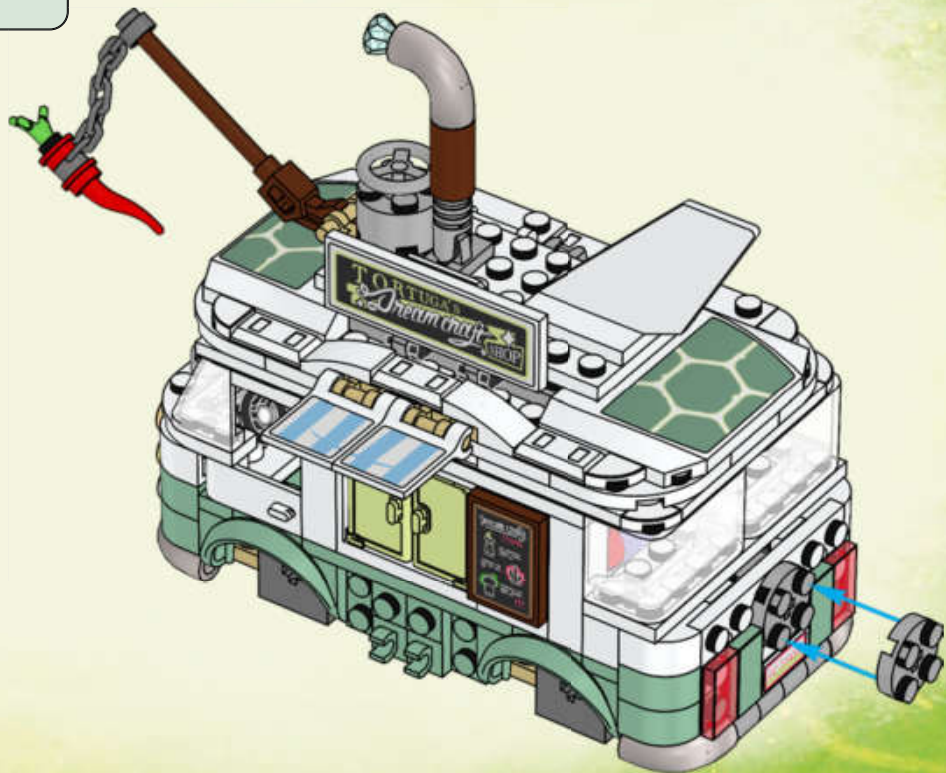

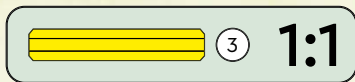

11

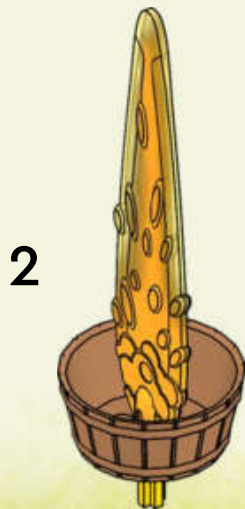
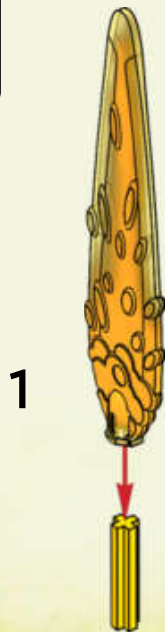

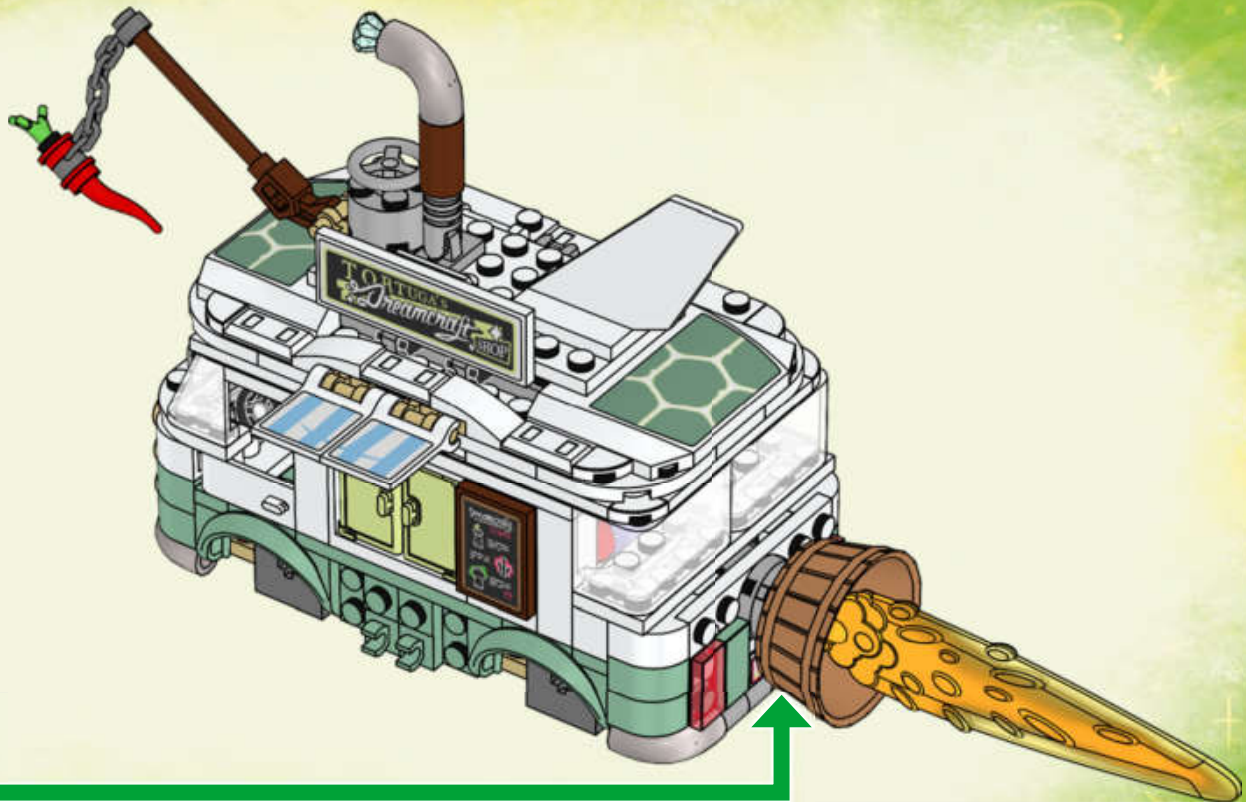





2x



1x



1x



1x

12

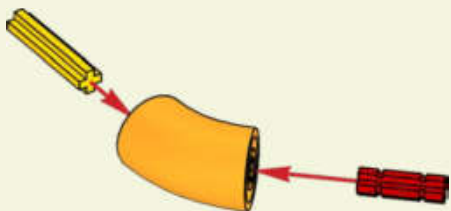

3

1:1



1x



1x

13

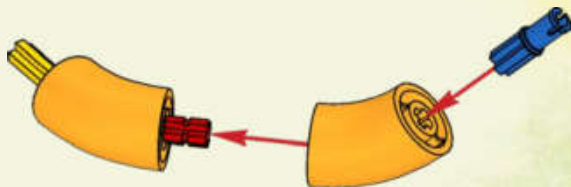

14



2x

15

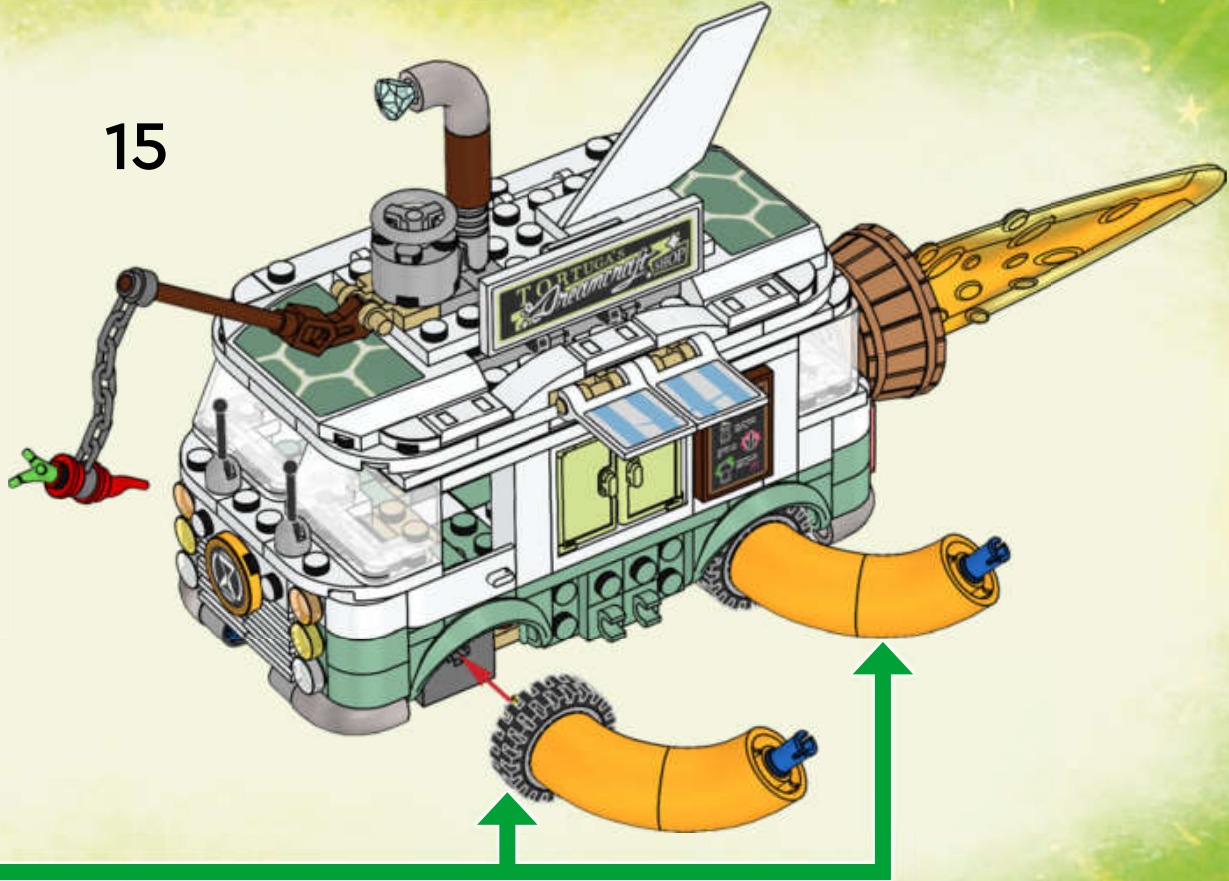



2x



2x



2x



2x



2x



6x

16

1



2

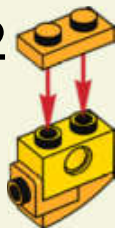

3



2x

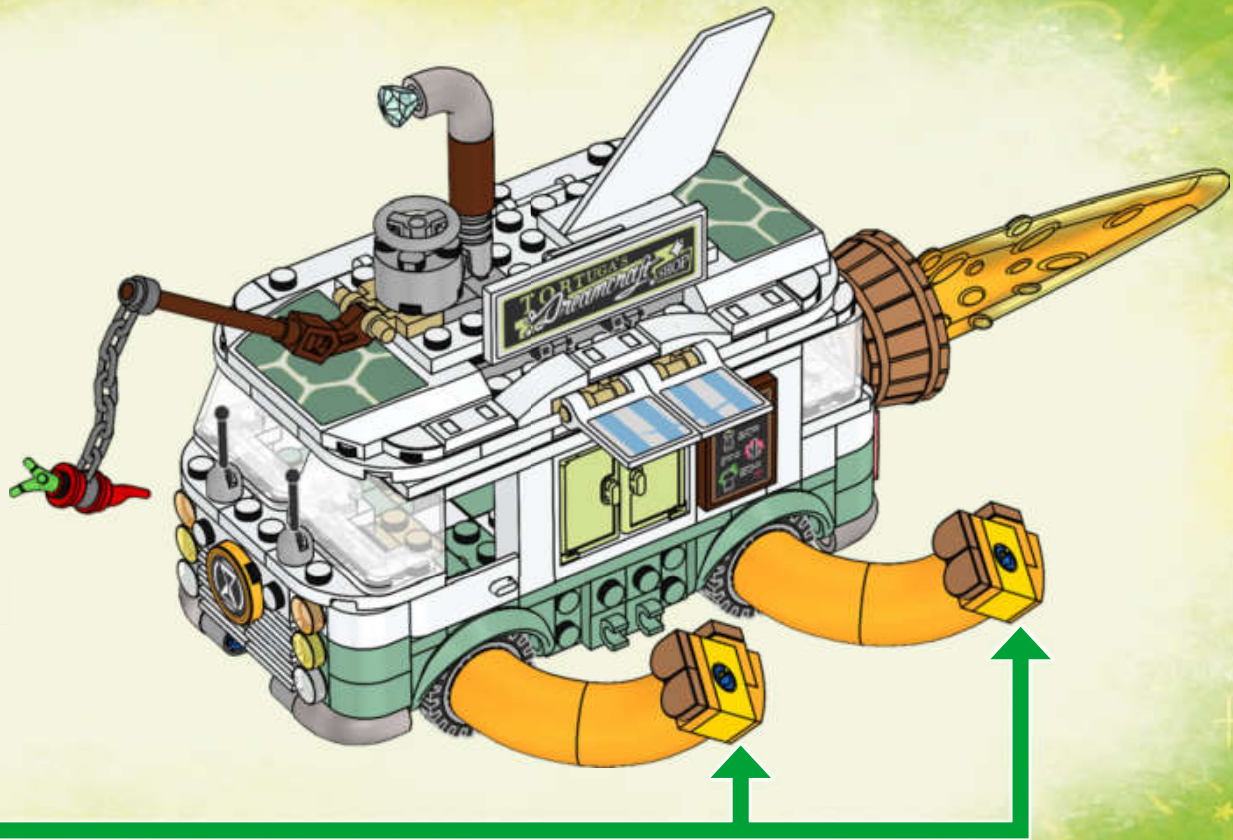



2x



1x



1x

3



1x

17

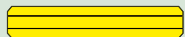
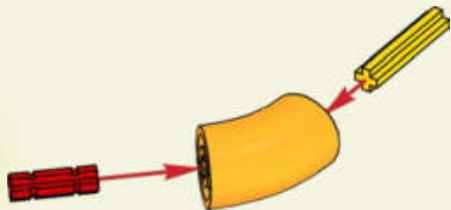

3

1:1



1x



1x

18

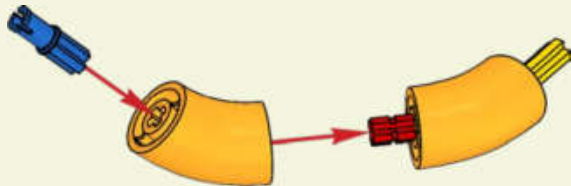

19



2x

20

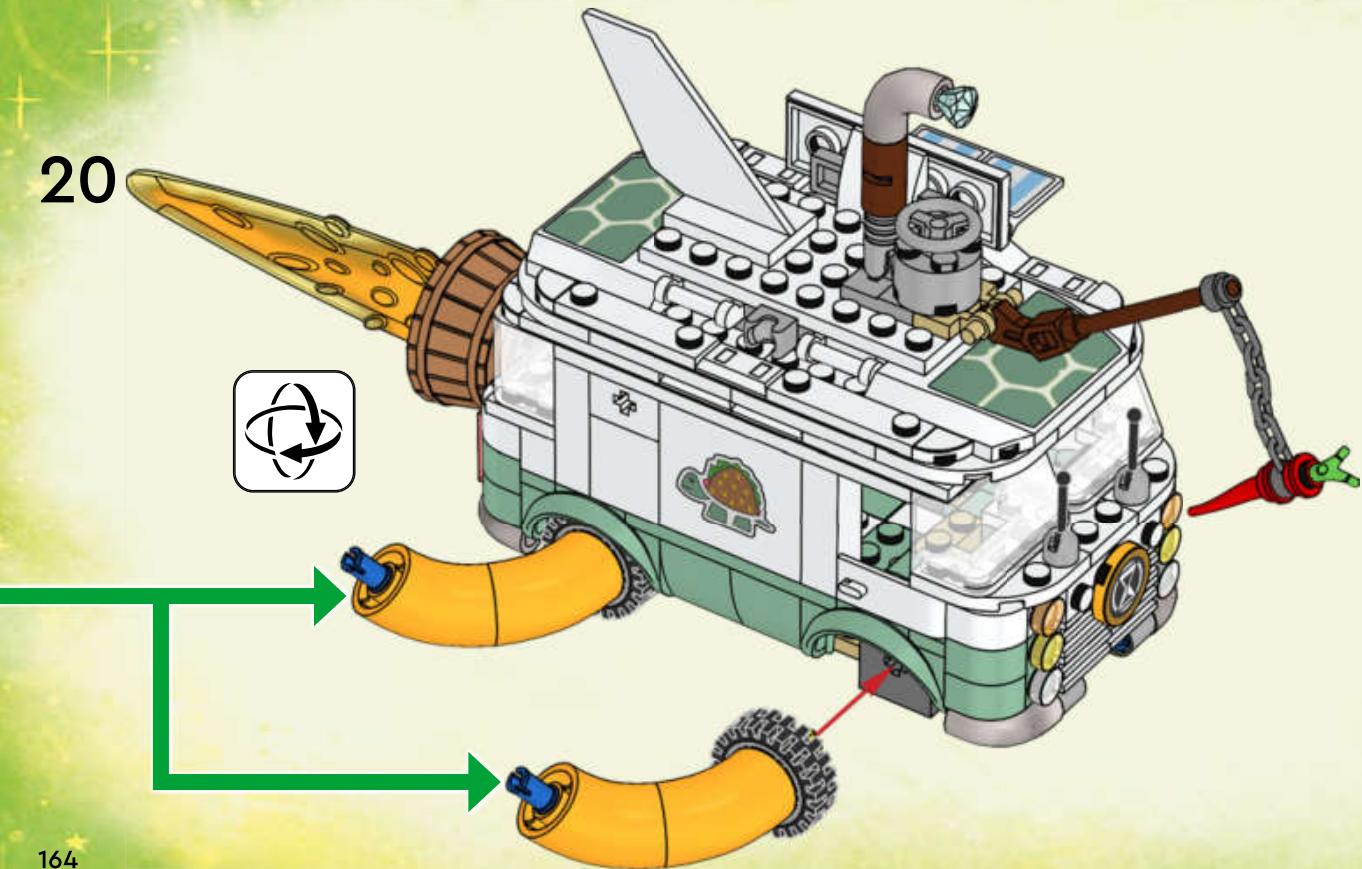



2x



2x



2x



2x



2x



6x

21

1



2

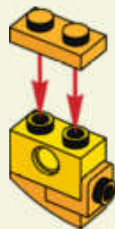

3



2x

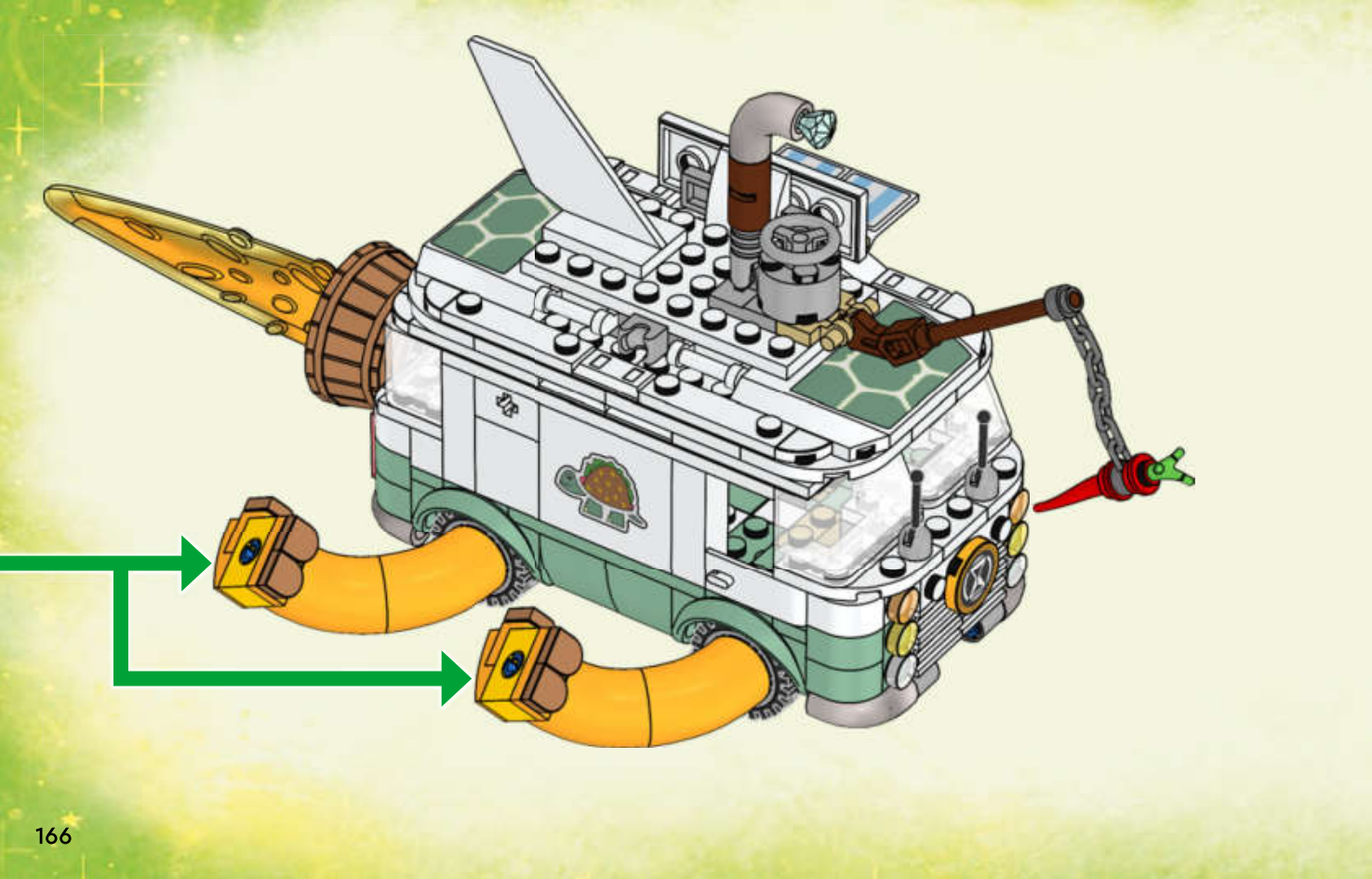



1x

22



2x

23

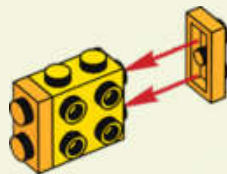



2x

24



1x

25





2x



1x

26

1



2



2x

27





1x



1x

28



1x

29





30



31



32

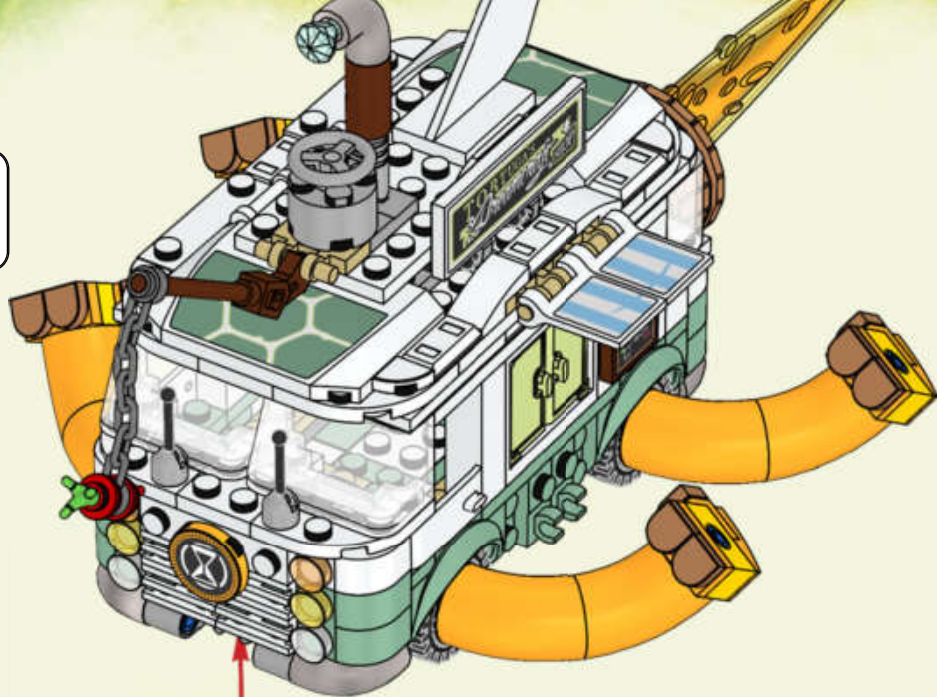
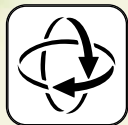

BRWOOOOO...

YAAAHH!!





DREAMZZZ



71453



71454



71455



71459



71460



71456



71457



71458



71461



71469



LEGO.com/DREAMZZz

Watch series online
Schau dir die Serie online an
Regarde la série en ligne
Guarda la serie online
Mira la serie en Internet
Assistir à série online
在线观看
Oglądaj serial w internecie
Sleduj serial online
Pozri si serial online
Nézd a sorozatot online
Vizionează serialul online
Глядите сериала онлайн
Skaties seriālu tiešsaistē
Vaata sarja veebist
Žiūrėk serialą internetu



LEGO



DREAMZZZ



**WATCH
SERIES
ONLINE**



7 [LEGO.com/DREAMZZZ](https://www.lego.com/DREAMZZZ)



1x
6332042



1x
4527947



2x
4261565



1x
303401



2x
447701



3x
303501



1x
6434196



1x
4518400



4x
6055541



2x
300501



6x
6172366



1x
6442897



1x
6058177



2x
4113261



4x
241201



1x
6178921



1x
6178921



8x
6210076



7x
306901



2x
6034044



4x
6285777



1x
4537987



2x
6365487



2x
4222017



3x
6126046



1x
302201



1x
6210385



4x
6289797



1x
4527637



4x
4550745



2x
6158058



3x
302101



10x
6249091



1x
4530590



1x
371001



1x
371001



1x
9551



1x
4558208



2x
6339103



1x
4173943



2x
6123809



2x
6043656



2x
663601



1x
366601



1x
366601



3x
4211475



1x
6271539



1x
4211526



1x
6092956



2x
6123809



2x
6043656



1x
6448319



1x
6276045



1x
6276045



2x
4221775



1x
4211483



6x
6225230



4x
6044729



1x
6265742



1x
6448319



1x
6276045



1x
6276045



2x
4210633



1x
6434202



1x
6311445



2x
6454959



1x
4549999



1x
4549999



1x
4211401



1x
4211401



1x
6275806



4x
4107761



1x
6434214



1x
6349966



4x
4541455



2x
4162443



2x
6401209



1x
244526

178



1x
6430884



1x
6344752



1x
6210270



1x
6143850



2x
6266207



1x
4225201



1x
6089119



1x
6430879



1x
6451947



2x
6251290



1x
6247792



1x
6301313



2x
6274740



1x
6303223



2x
6274747



2x
6274738



2x
6440804



2x
6240532



2x
6253681



1x
6301802



1x
6170292



1x
6443455



1x
6442192



1x
6247799



1x
6408044



1x
6408044



1x
6408044



1x
6447085



3x
6190251



2x
6310282



1x
6429057



2x
6327441



2x
6132372



2x
6310290



1x
4500125



1x
6434232



1x
6013530



4x
6099189



6x
4616578



2x
6360075



8x
6411367



2x
6080431



2x
6186823



2x
6249817



4x
6439725



3x
6099187



1x
6209679



1x
6284587



2x
6428820



1x
6291414



4x
6411022



1x
6434871



1x
6434208



1x
6432441



1x
6194726



12x
4206482



1x
6434230



1x
6447374



1x
6443399



4x
6097419



1x
4653970



4x
6119107



1x
6070757



3

 [LEGO.com/service](https://www.LEGO.com/service)



YOU COULD
WIN



Scan this QR code or go to
LEGO.COM/PRODUCTFEEDBACK and give
us your short feedback about this LEGO® set
for a chance to win a cool LEGO prize.

Terms and Conditions apply*



EN: YOU COULD WIN. Terms and Conditions apply* **DE: Du könntest GEWINNEN.** Es gelten die Teilnahmebedingungen* **FR: Tu pourrais GAGNER.** Des conditions s'appliquent* **IT: Potresti VINCERE tu.** Termini e condizioni sono applicabili* **ES: Puedes GANAR.** Aplican términos y condiciones* **PT: Poderá GANHAR.** Aplicam-se termos e condições* **ZH: 轻松获奖. 条款和条件适用*** **PL: Szansa na WYGRANĄ.** Obowiązują warunki korzystania* **CS: Máte šanci VYHRÁT.** Platí všeobecné smluvní podmínky* **SK: Máte šancu VYHRAŤ.** Platia všeobecné zmluvné podmienky* **HU: TE IS NYERHETSZ.** Felhasználási feltételek érvényesek* **RO: Ai putea CÂȘTIGA.** Se aplică termenii și condiții* **BG: Можете да СПЕЧЕЛИТЕ.** Има определени правила и условия* **LV: Tu vari LAIMĒT.** Ir spēkā noteikumi un nosacījumi.* **ET: Sul on võimalus VÕITA.** Kehtivad tingimused* **LT: Jūs galite LAIMĖTI.** Taikomos sąlygos*

*[LEGO.com/productfeedback-terms](https://www.lego.com/productfeedback-terms)

LEGO, the LEGO logo and DREAMZzz are trademarks of the LEGO Group. ©2023 The LEGO Group. 6500737