



# DREAMZZZ

71455





 **FR**  
**DONNEZ**  
OU  
**RECYCLEZ**

 OU  OU   
ASSOCIATION MAGASIN DÉCHÈTERIE

Adresses sur [quefairedemesdechets.fr](http://quefairedemesdechets.fr)



[LEGO.com/sustainable-packaging](https://LEGO.com/sustainable-packaging)

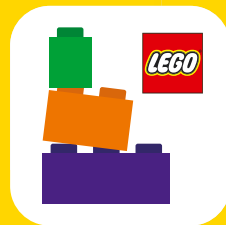

# BUILDER



Apple and the Apple logo are trademarks of Apple Inc., registered in the U.S. and other countries and regions. App Store is a service mark of Apple Inc.

Google Play and the Google Play logo are trademarks of Google LLC.

Tencent and the Tencent logo are trademarks of Tencent Inc.

Q [LEGO.com/devicecheck](https://www.lego.com/devicecheck)

EN Ask parents' permission before going online | DE Eltern um Erlaubnis bitten, bevor du online gehst | FR Demande l'autorisation d'un parent avant d'aller en ligne | IT Chiedi il permesso ai tuoi genitori prima di andare online | ES Pídeles permiso a tus papás antes de conectarte a Internet | PT Pede autorização aos pais antes de acederes online | ZH 上网前应先征得父母的同意 | PL Poproś rodziców o zgodę, zanim wejdiesz do Internetu | CS Než půjdeš na internet, požádej rodiče o svolení | SK Skôr než pôjdeš na internet, vypýtaj si povolenie od rodičov | HU Kérj szülői engedélyt, mielőtt online csatlakoznál! | RO Cere permisiunea părinților înainte de a te conecta online | BG Поискайте разрешение от родител, преди да влезете онлайн | LV Pirms došanās tiešsaistē palūdz atļauju vecākiem | ET Enne Interneti kasutamist küsi vanematelt luba | LT Prieš prisijungdami prie interneto, atsilkauskite tėvų













1

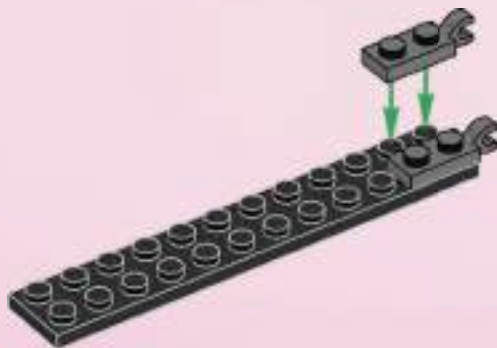



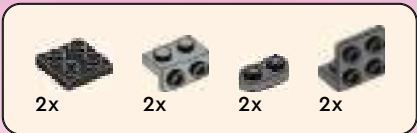

2

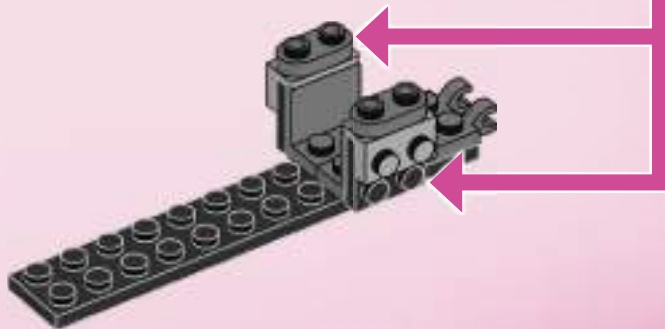
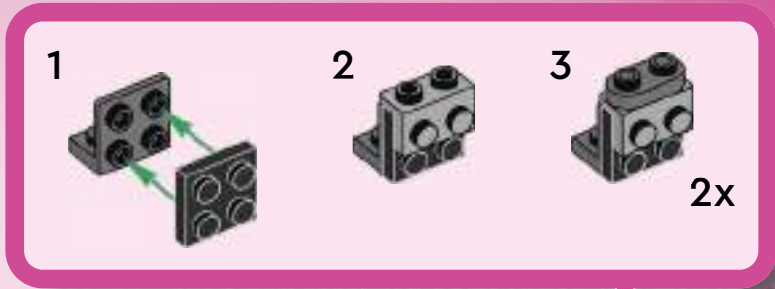



1x

3

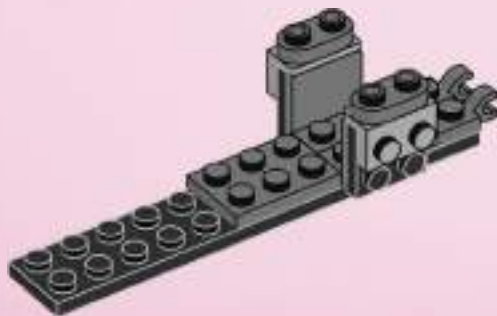



2x



2x

4

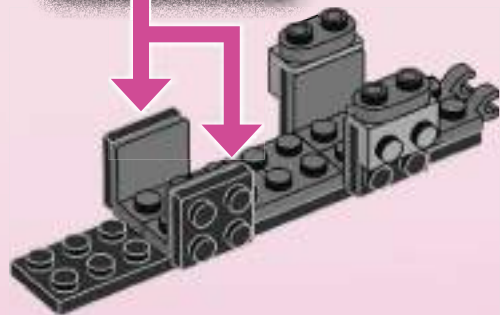
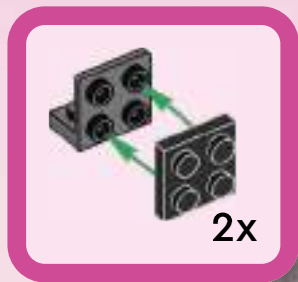

5



2x

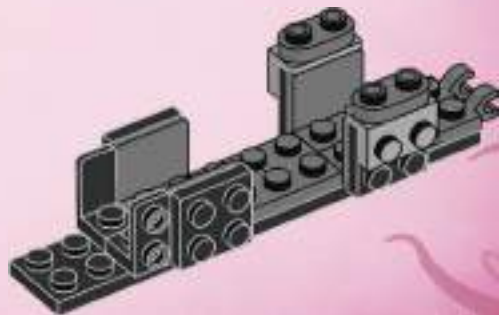



2x

6

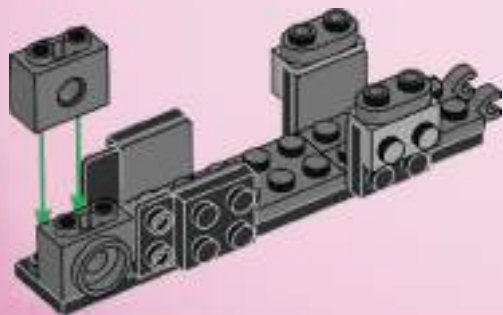

1x

7

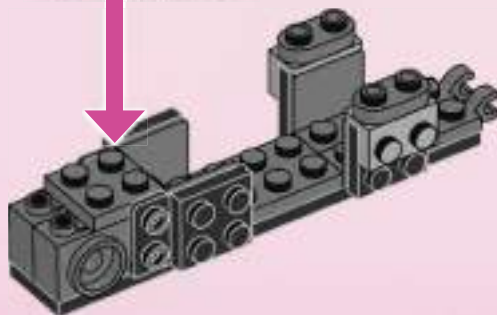
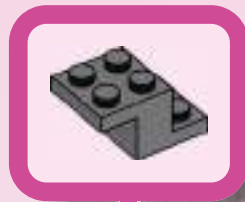



8

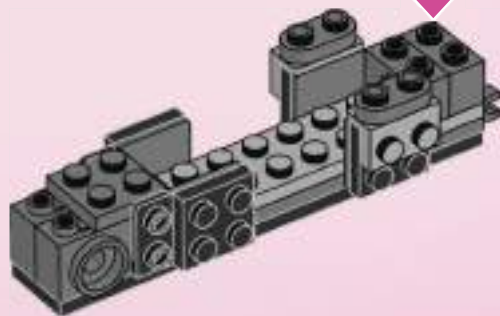
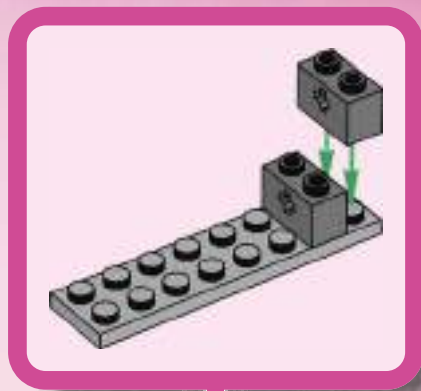





2x

9



2x

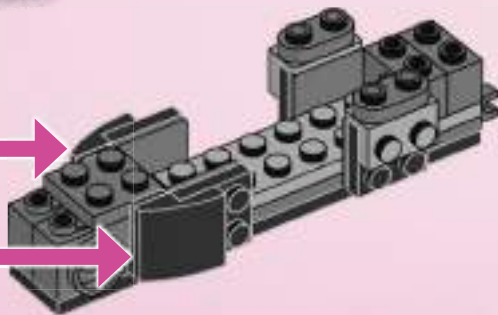



2x

10

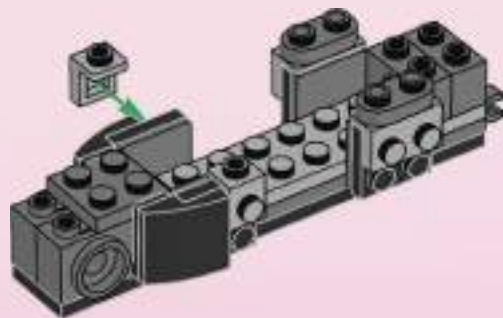

2x

11

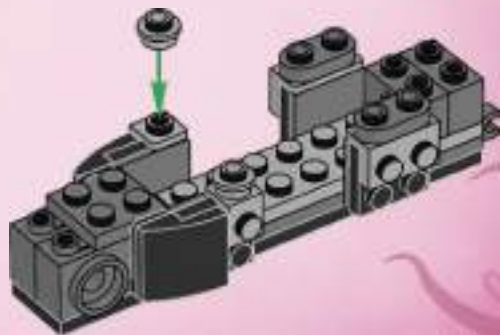



12

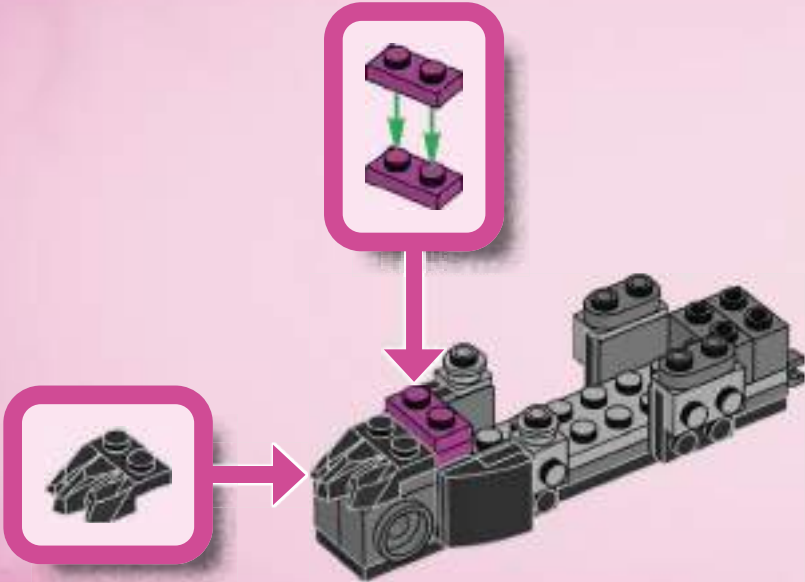



1x

13

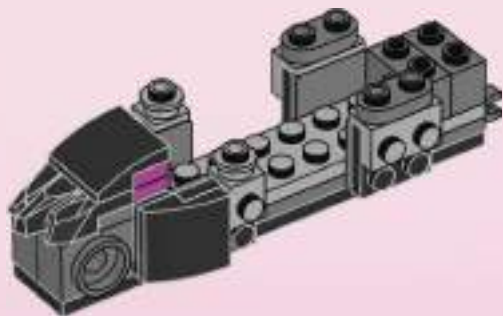

1x

14

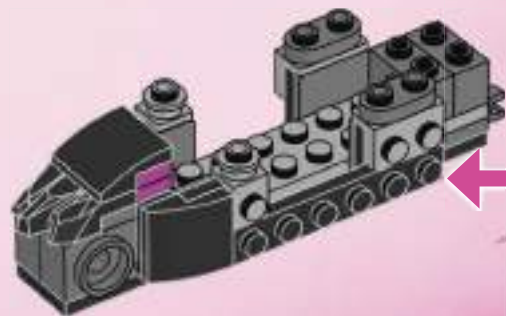

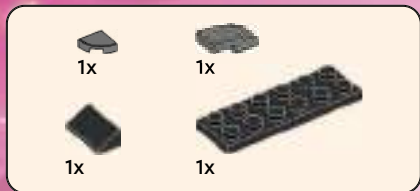

15

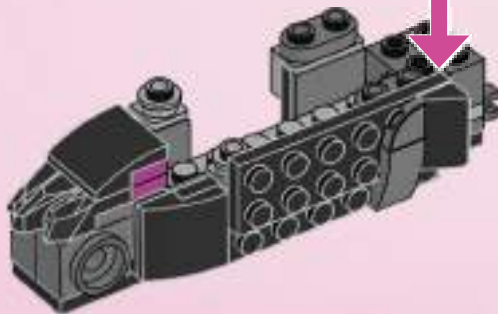
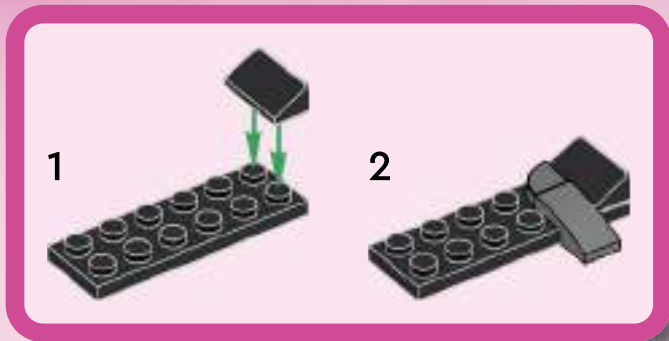





2x



2x

16

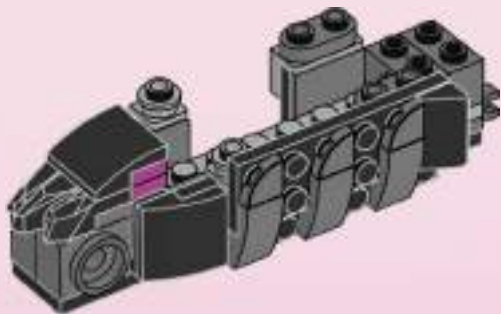

1x

17

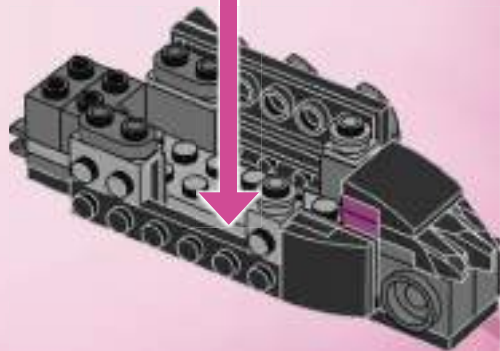
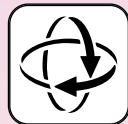

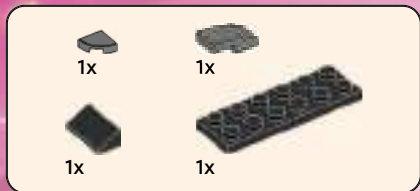

18

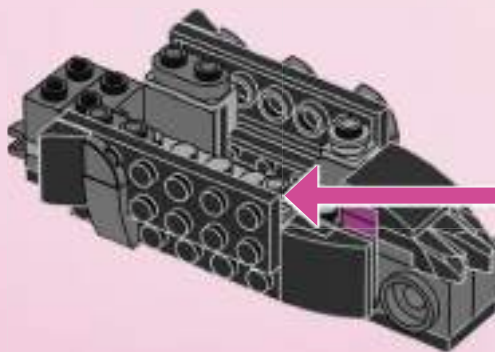
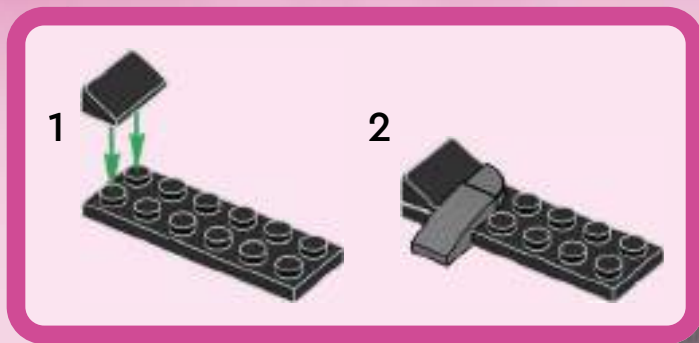



2x



2x

19

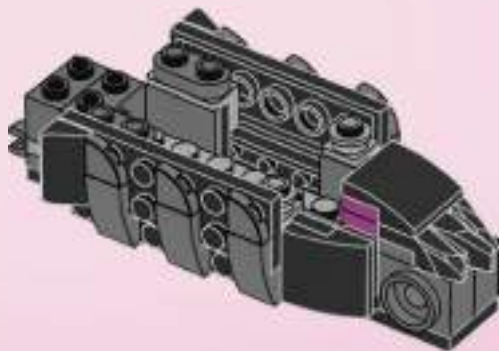



20



21

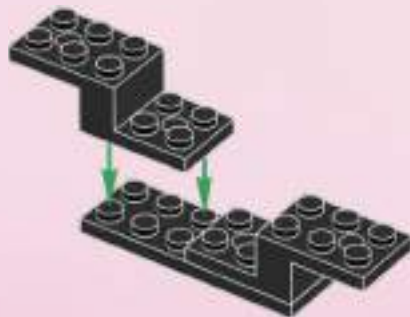



2x



2x

# 22



2x

# 23

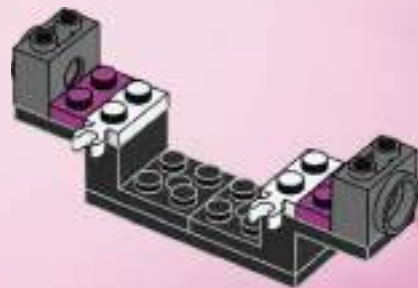





2x

24

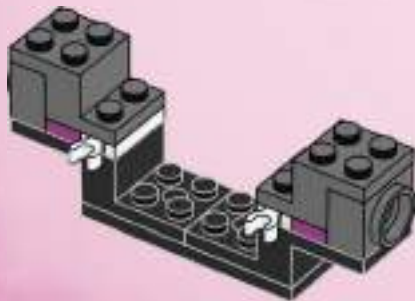

2x

25

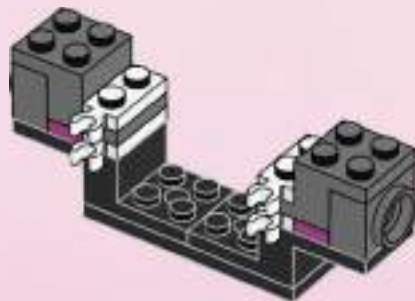



4x

26

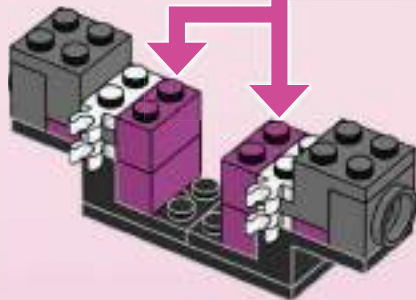
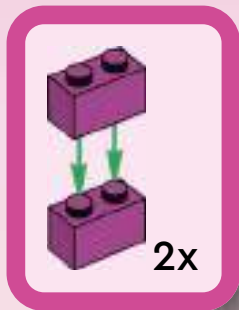

27

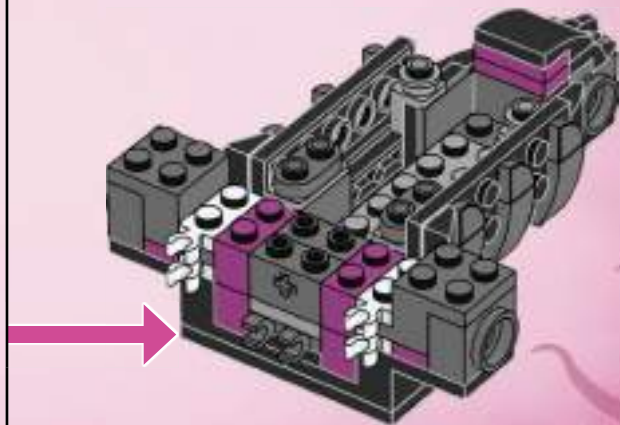



1x



2x

28

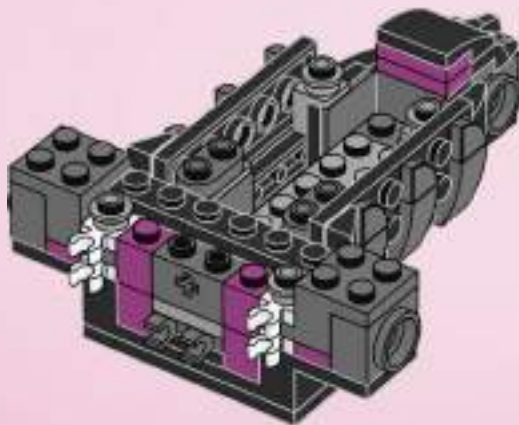



2x

29

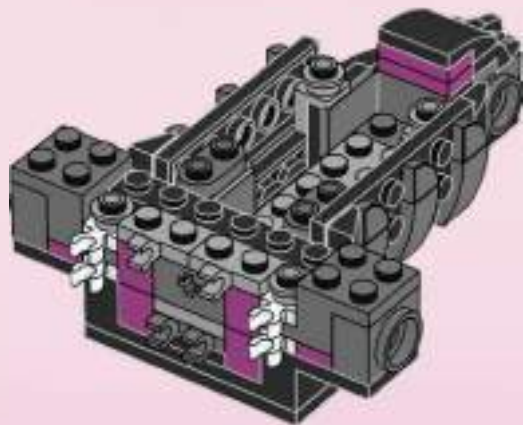

1x

30

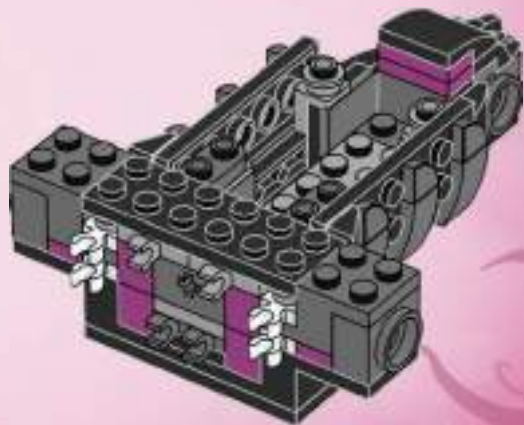



1x



2x



2x

31

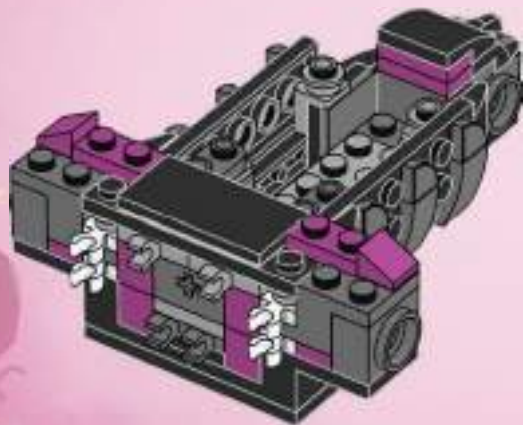

2x

32

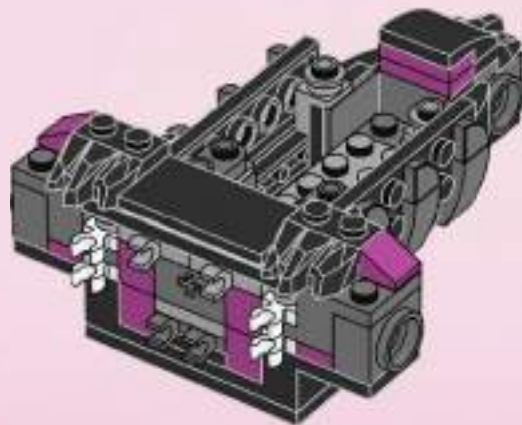

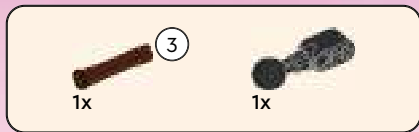

33

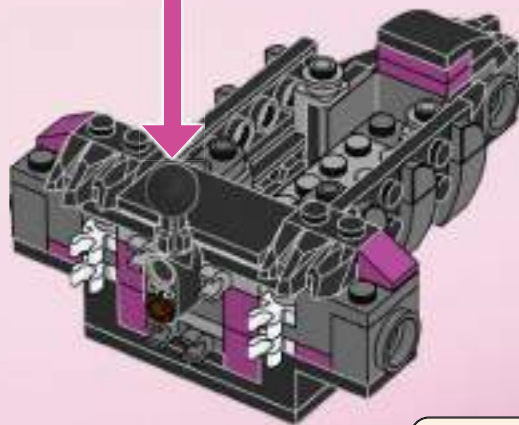



2x



2x

34

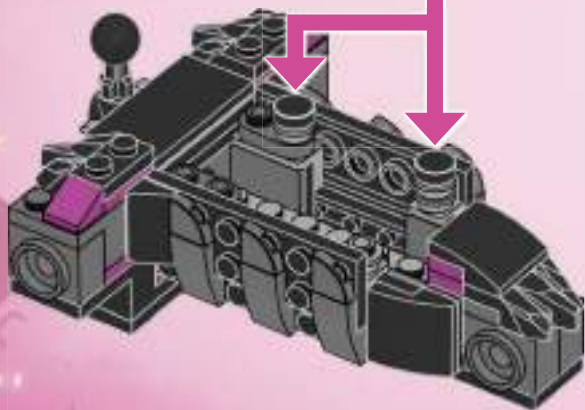

2x

35

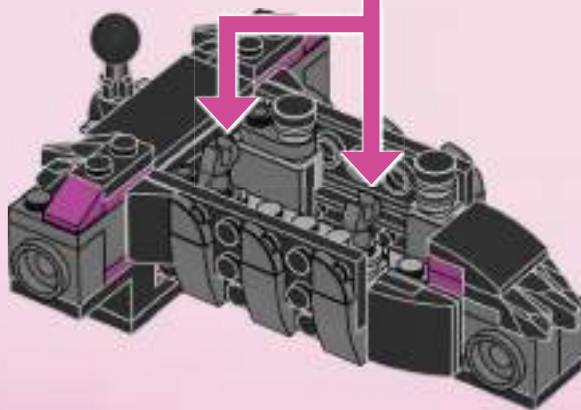



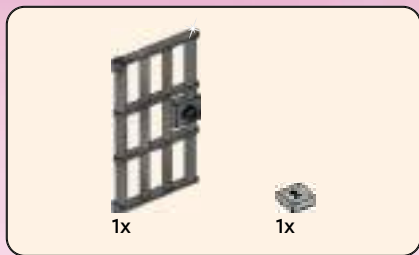

36

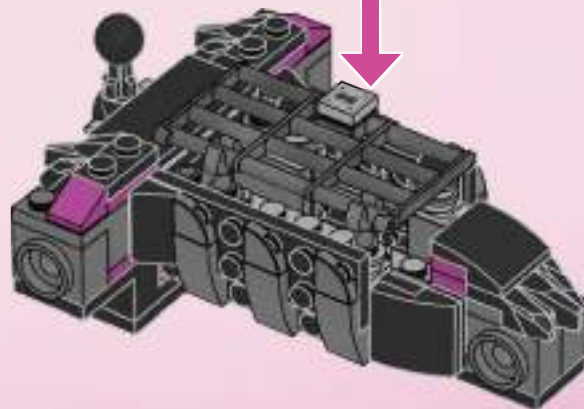
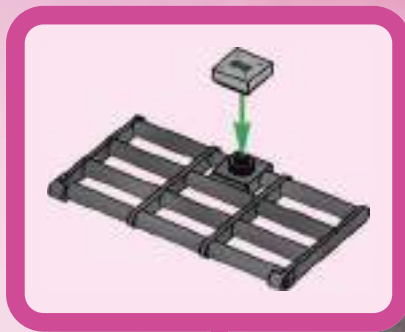



37

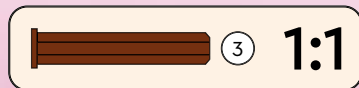



1x

38



2x

39





1x

40



1x

41

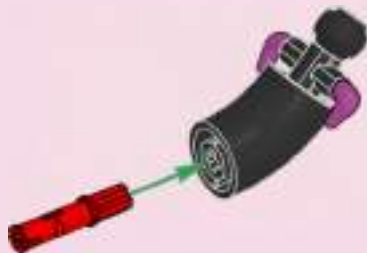



1x

42



1x

43



2x

44

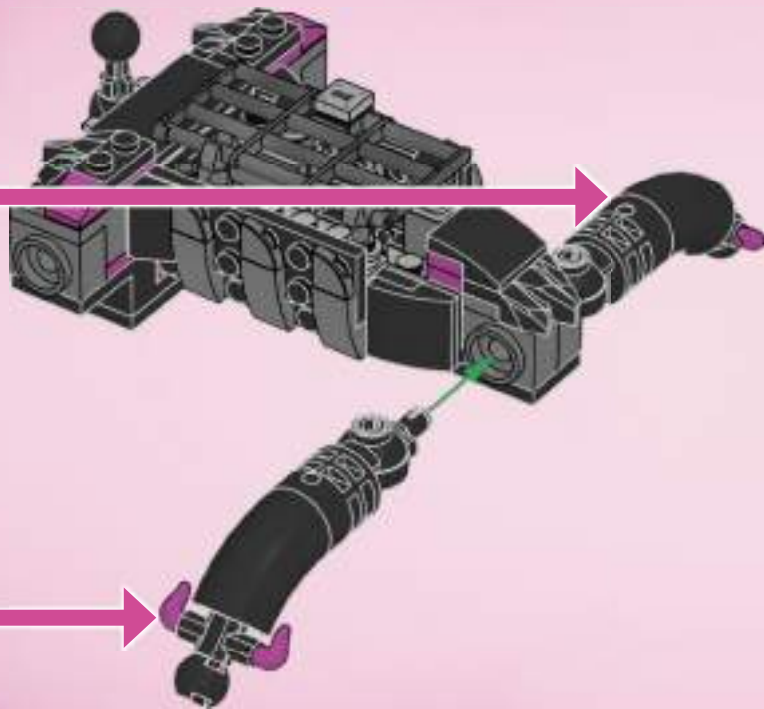

45

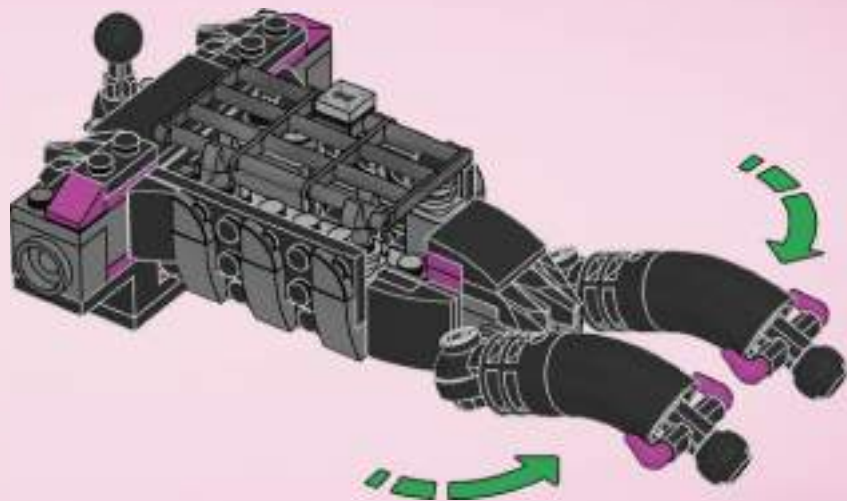



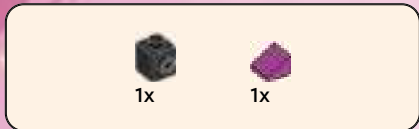

1x



1x

46



1x

47





1x



1x

48



1x



1x

49





50



51

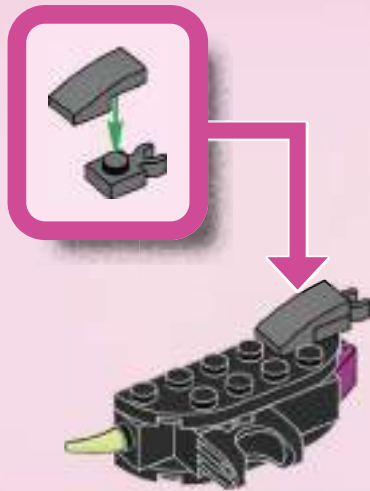



52

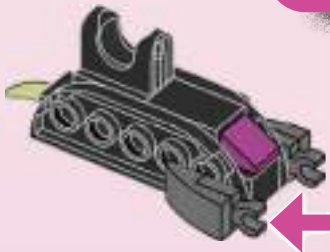

53

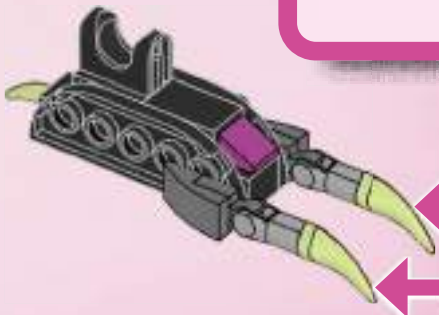

54

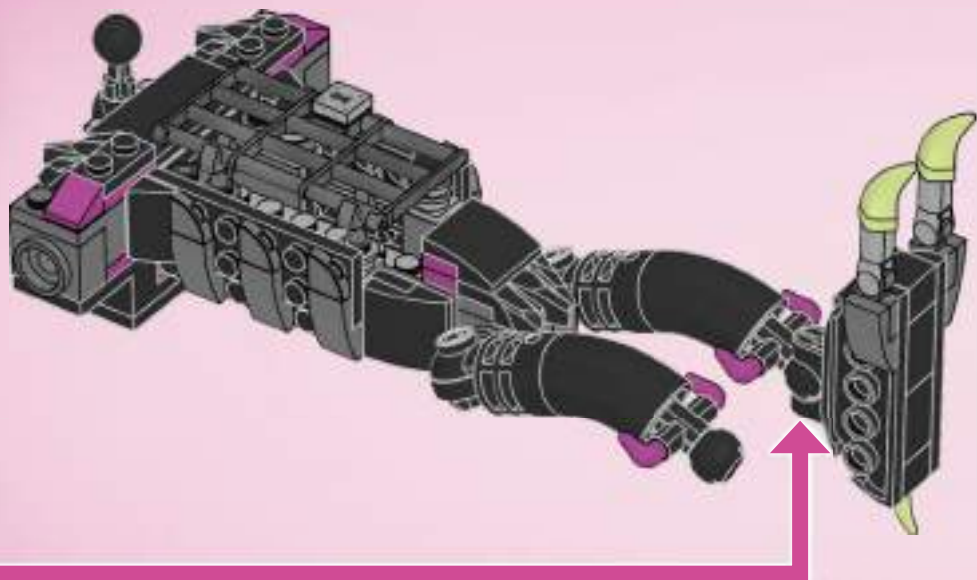



55



56





1x



1x

57



1x



1x

58

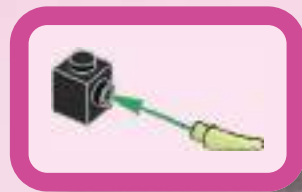





59



60

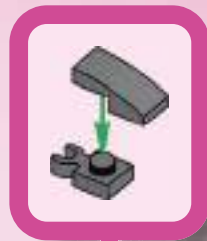



61

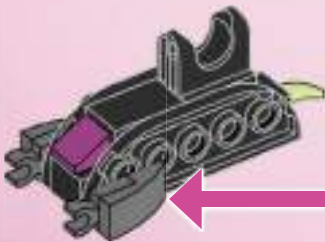

62

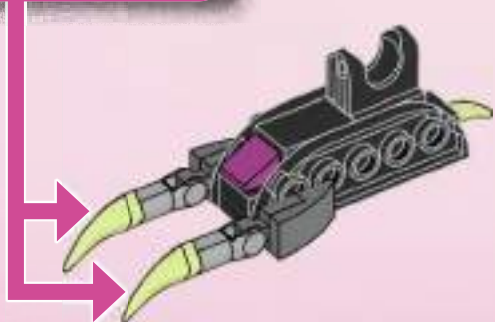
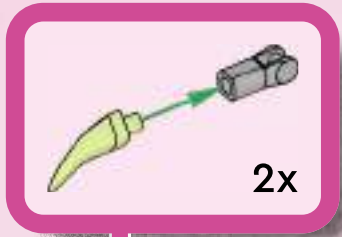

63

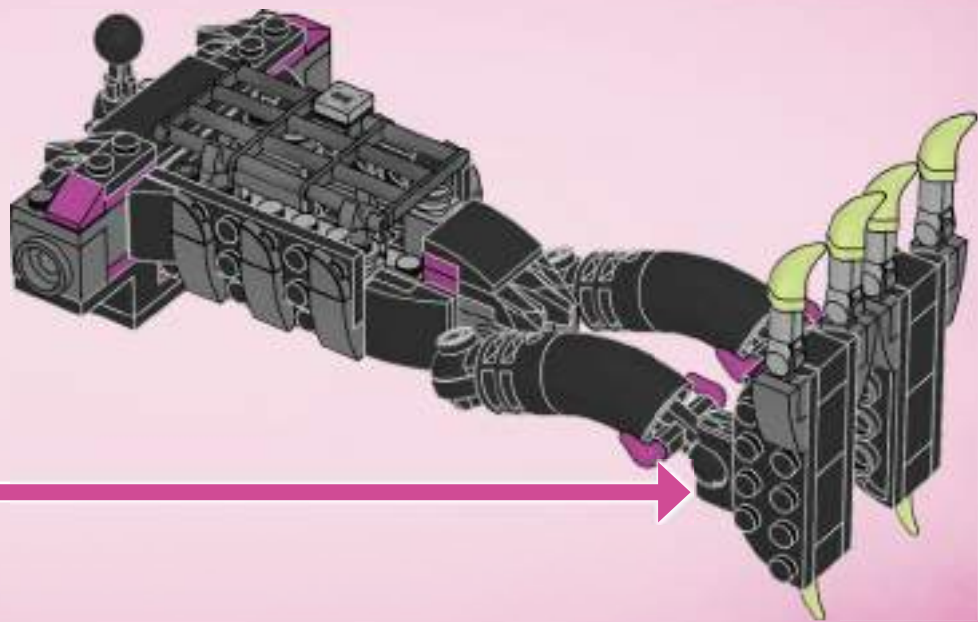



2x



2x



2x



2x



2x



2x

64

1



2

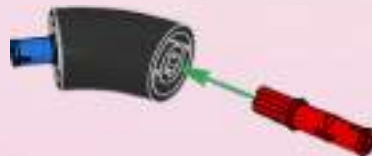

3



4



2x

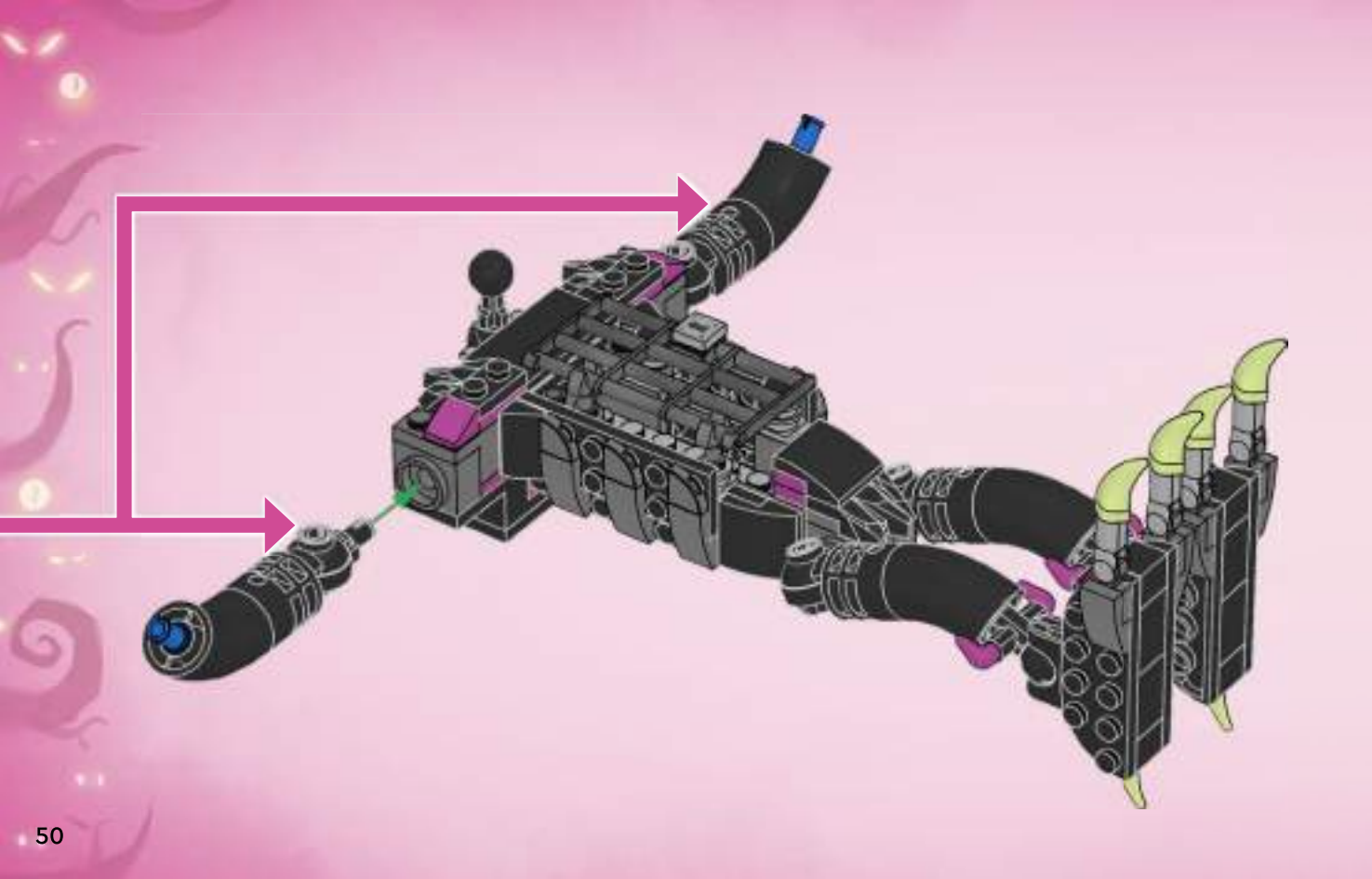

65

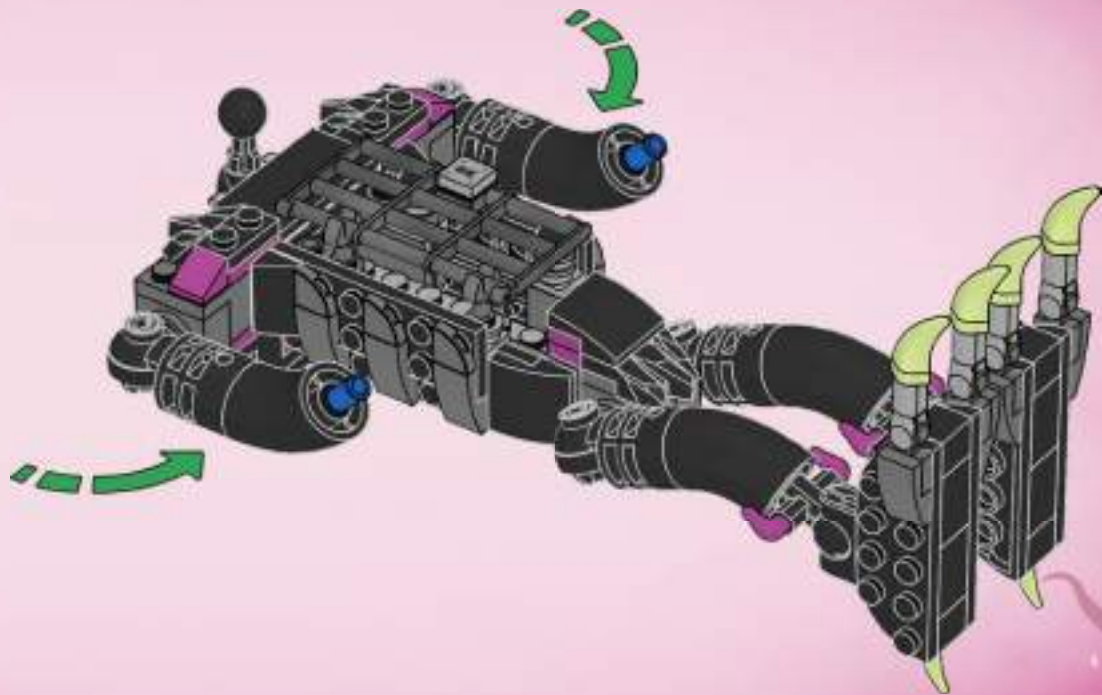



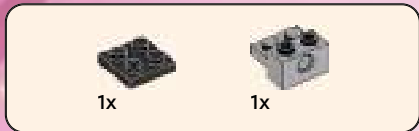

66



67





1x

68



1x



1x

69





1x

70



3x



3x

71

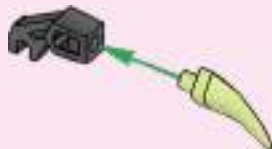

3x



72

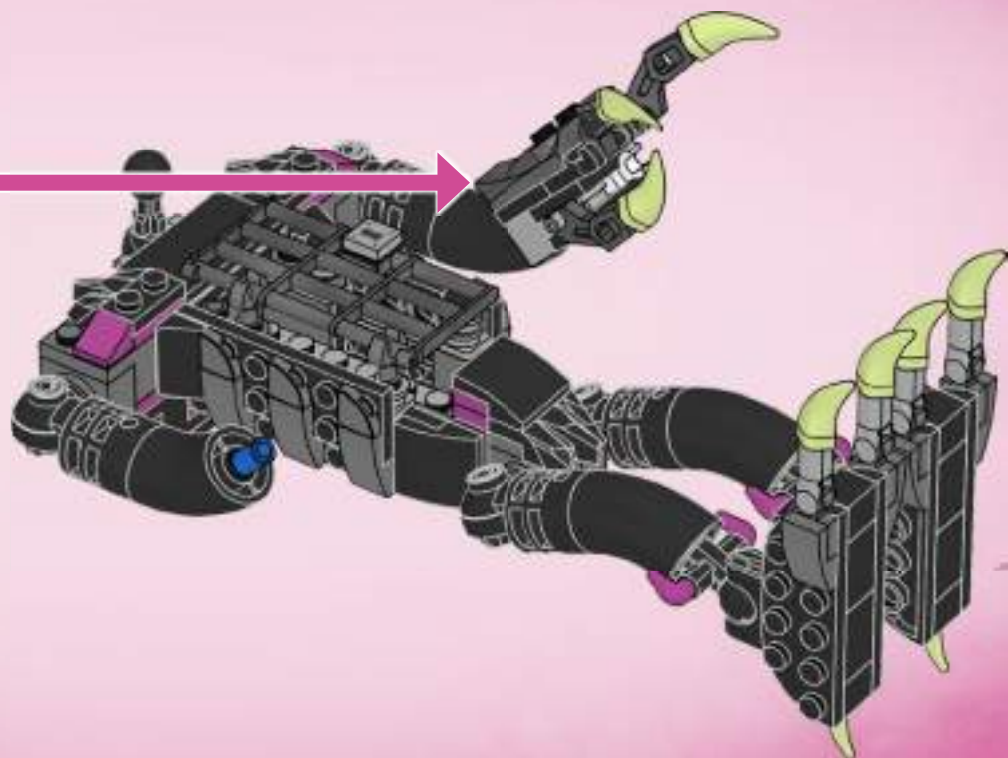

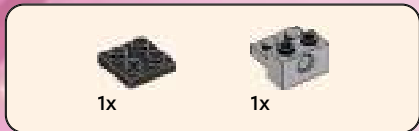

73



74





1x

75



1x



1x

76





1x

77



3x



3x

78

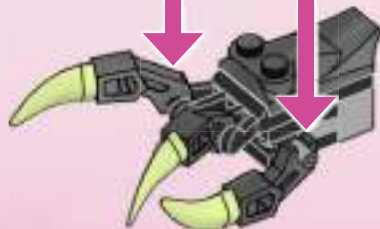
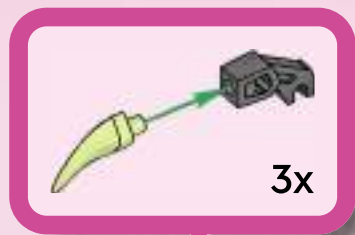

79

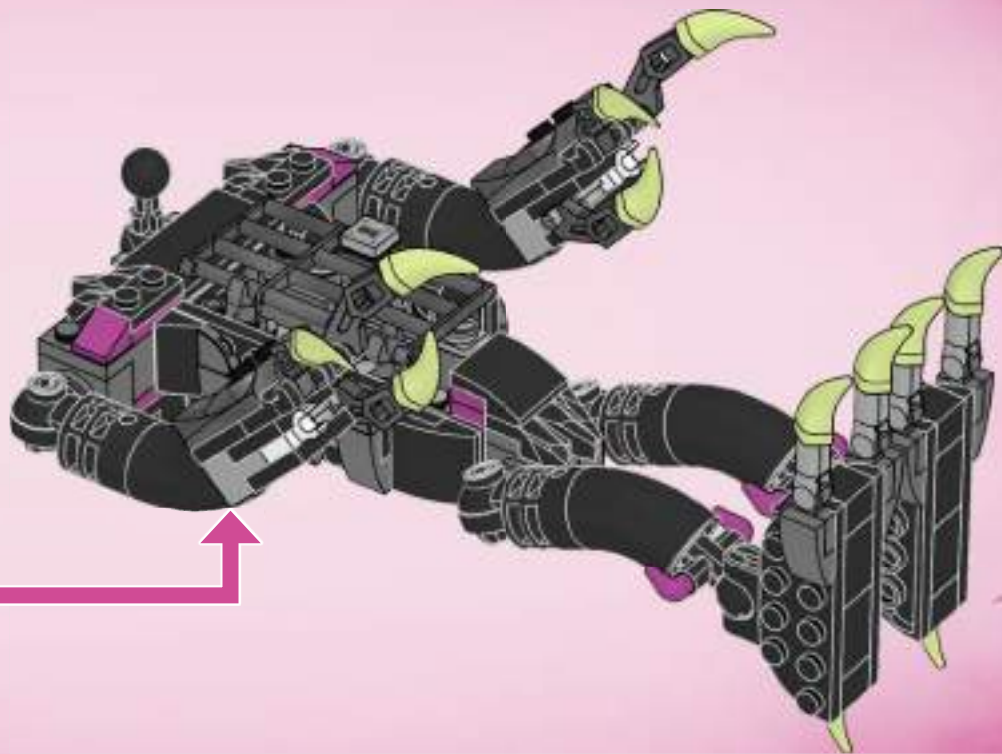





2x

80

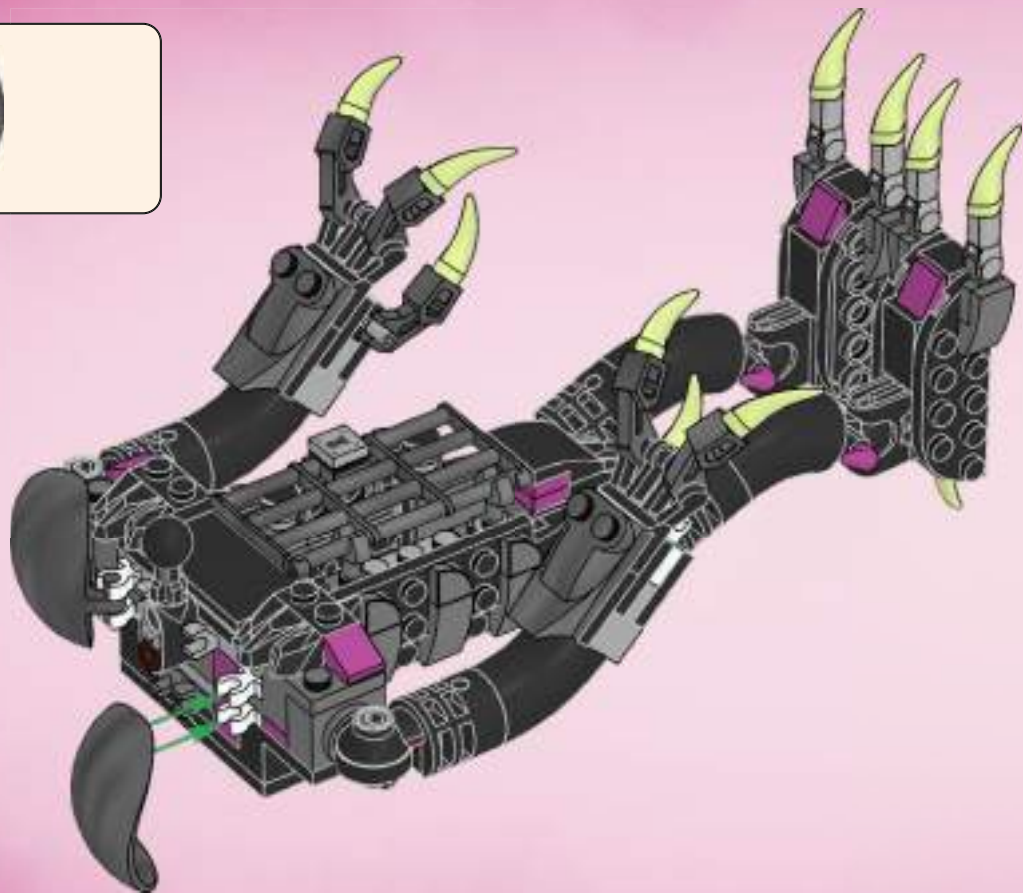



81

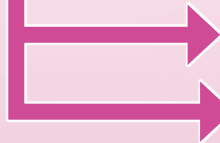
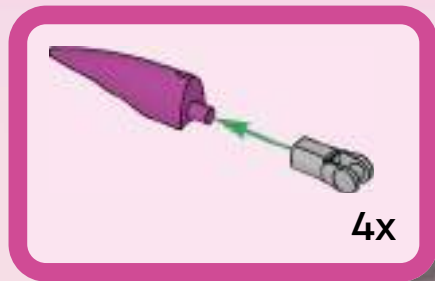



1x

82



1x

83



1x

84





1x

85



2x

86





1x

87



2x

88





89

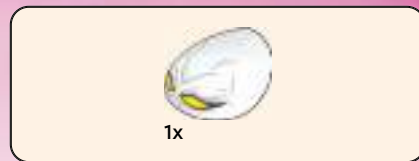
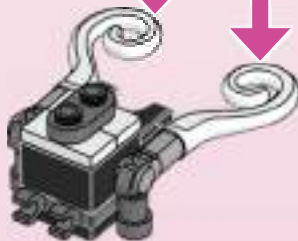
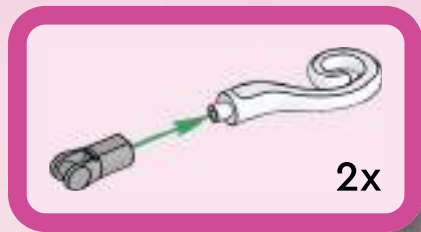

90



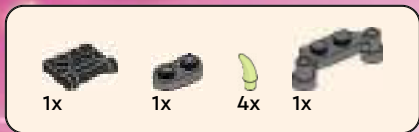

91

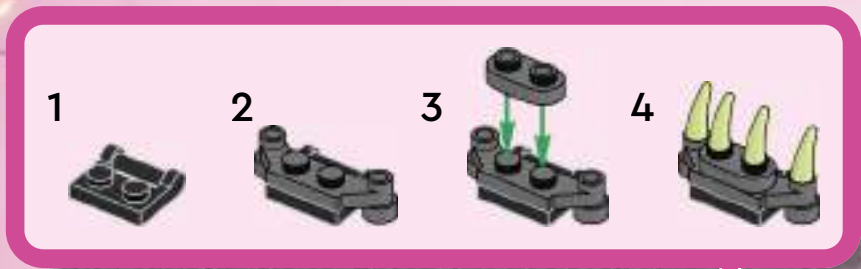

92

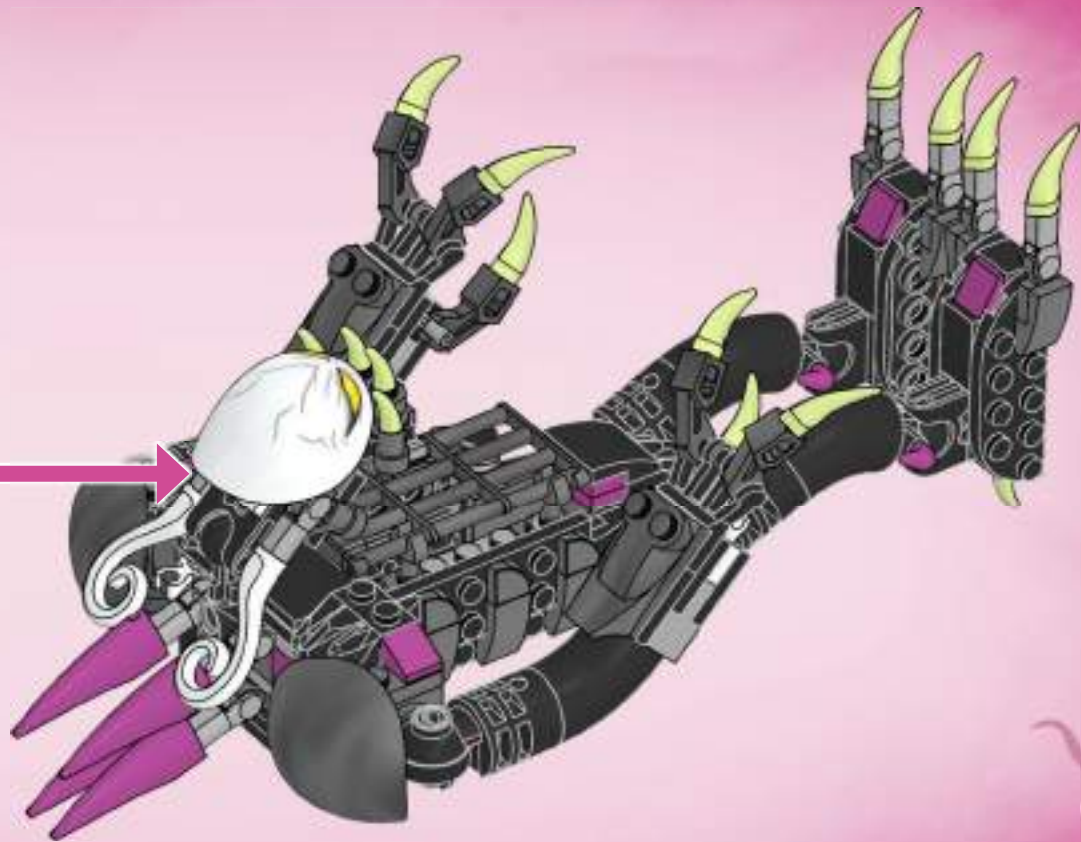





1x



1x

93



1x

94





1x



3x



1x

# 95

1



2





2x

96



1x

97



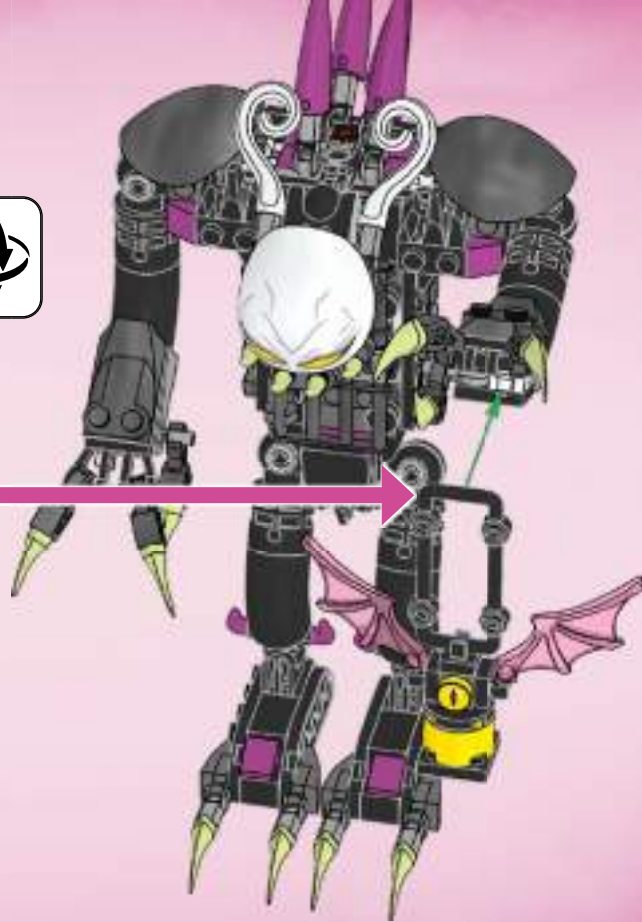

98







1







2







3

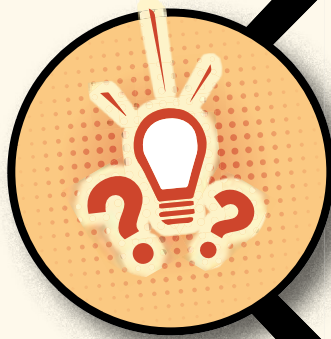



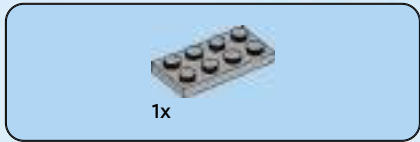

1





2

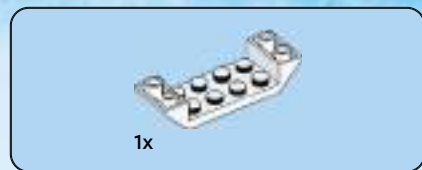
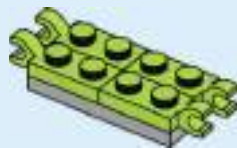

3





4

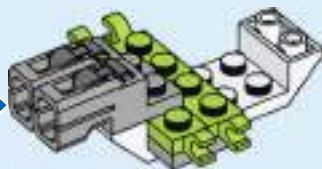
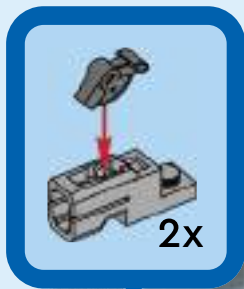



5

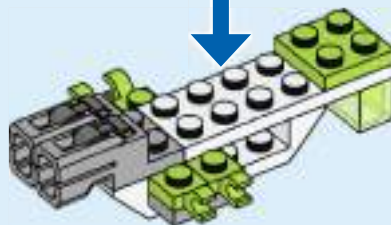
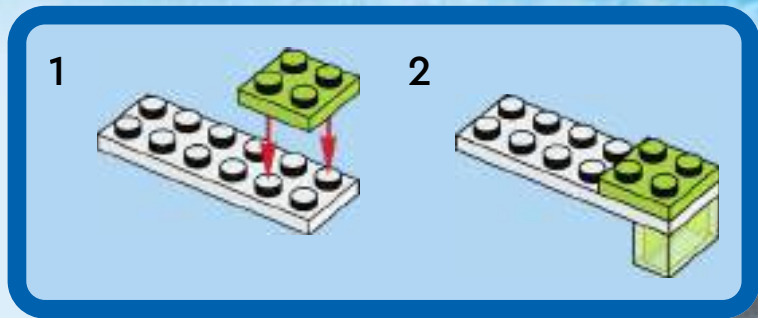

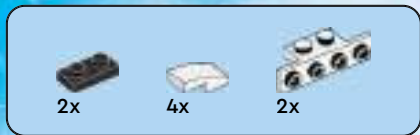

6

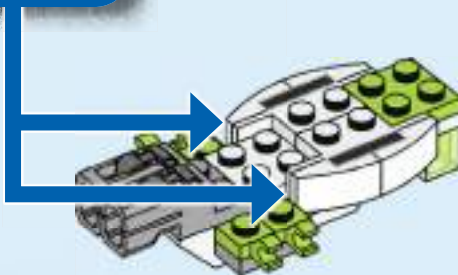
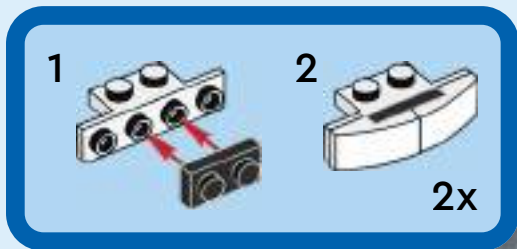



1x

7

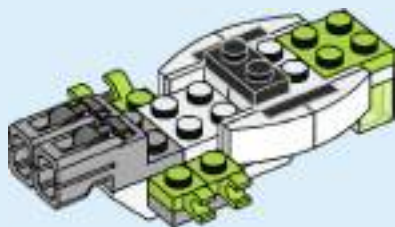

1x

8

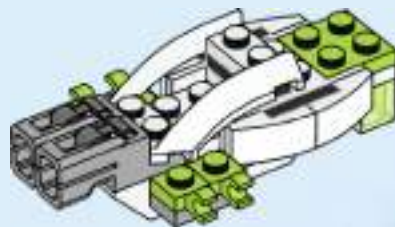





1x



2x

9

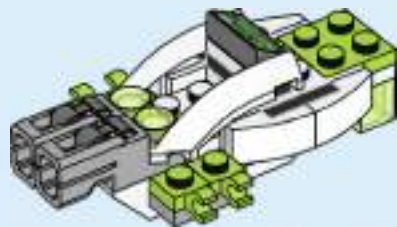

2x

10

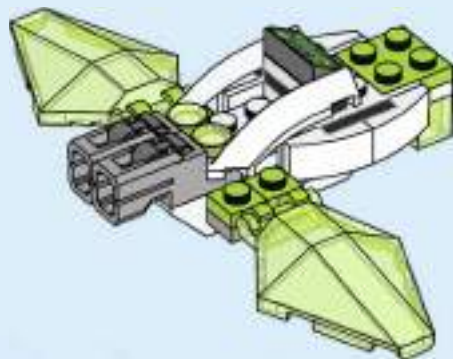



1x

11

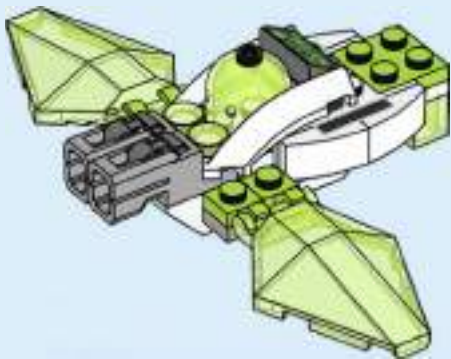

2x

12



2x

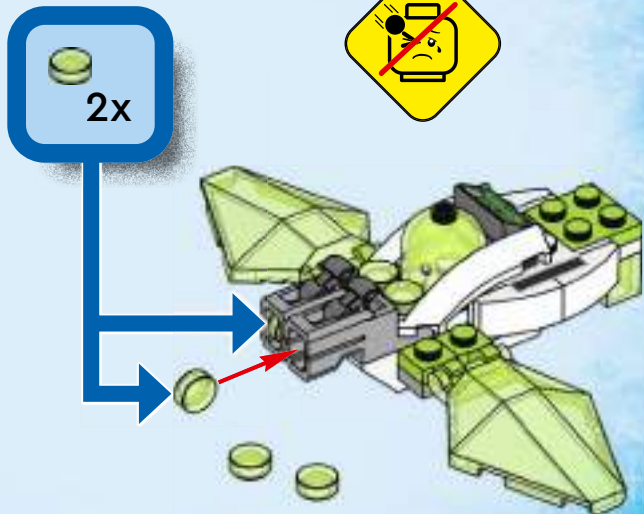

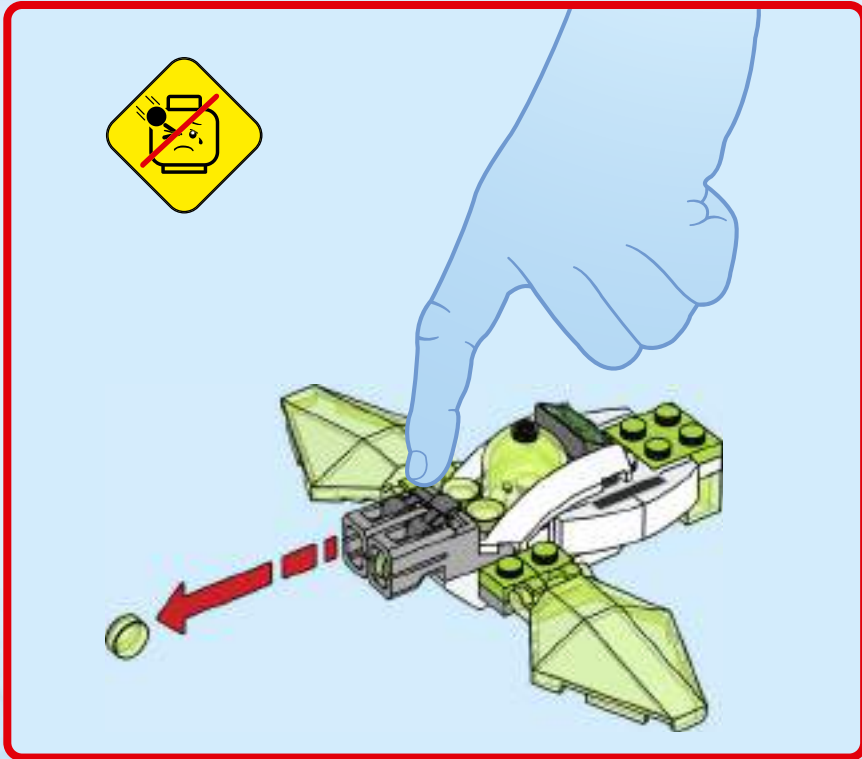





1





4x

2

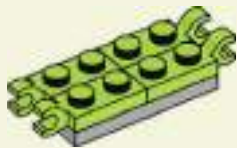

1x

3

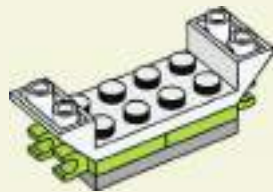





2x

4

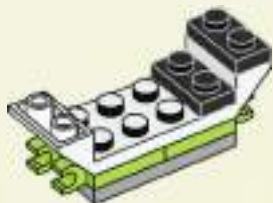

2x

5

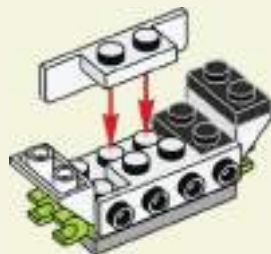



1x

6

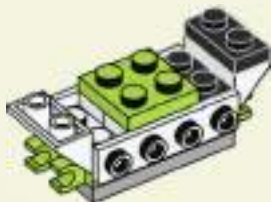

2x



2x

7

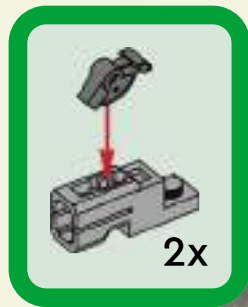

2x

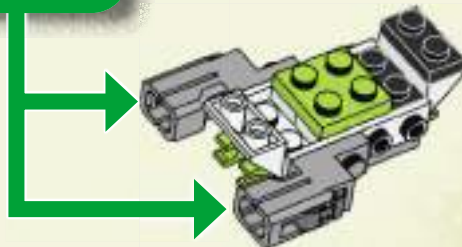





2x

8

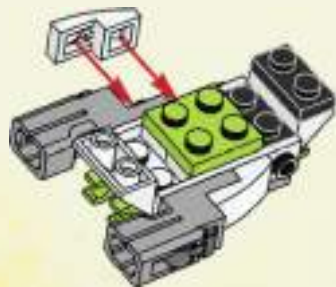

2x

9

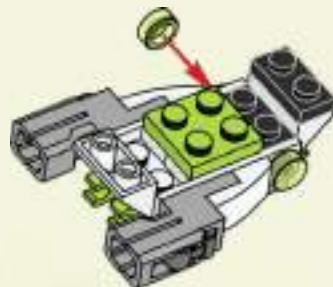



10

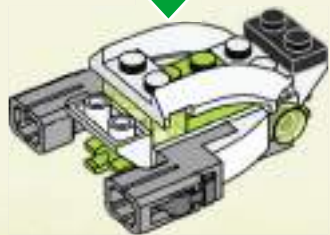
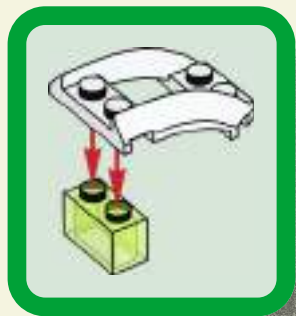

11

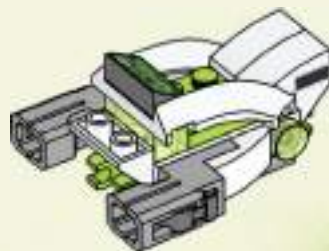



1x



1x

12

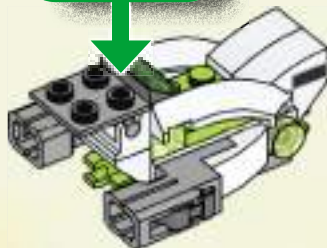
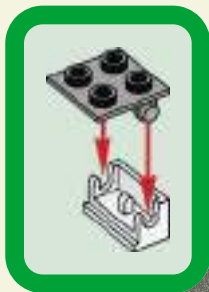

2x

13

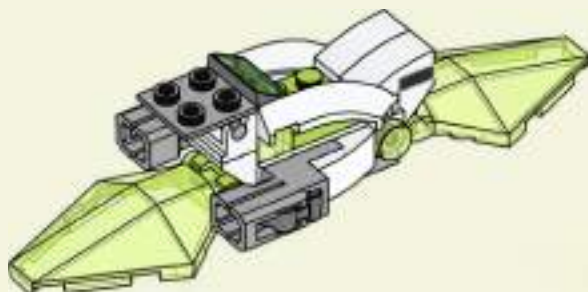



1x

14

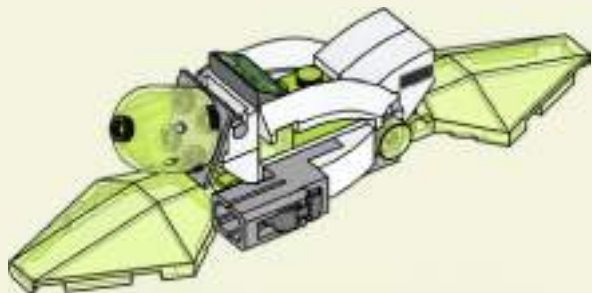

4x

15



2x

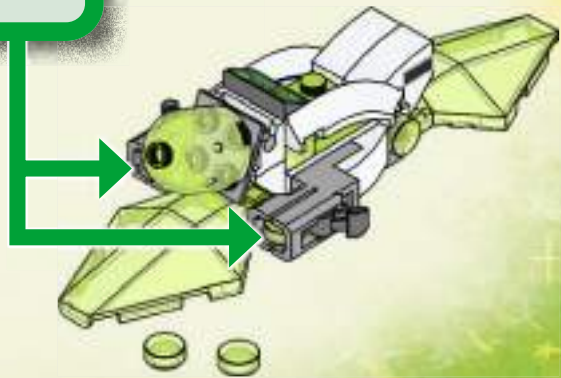

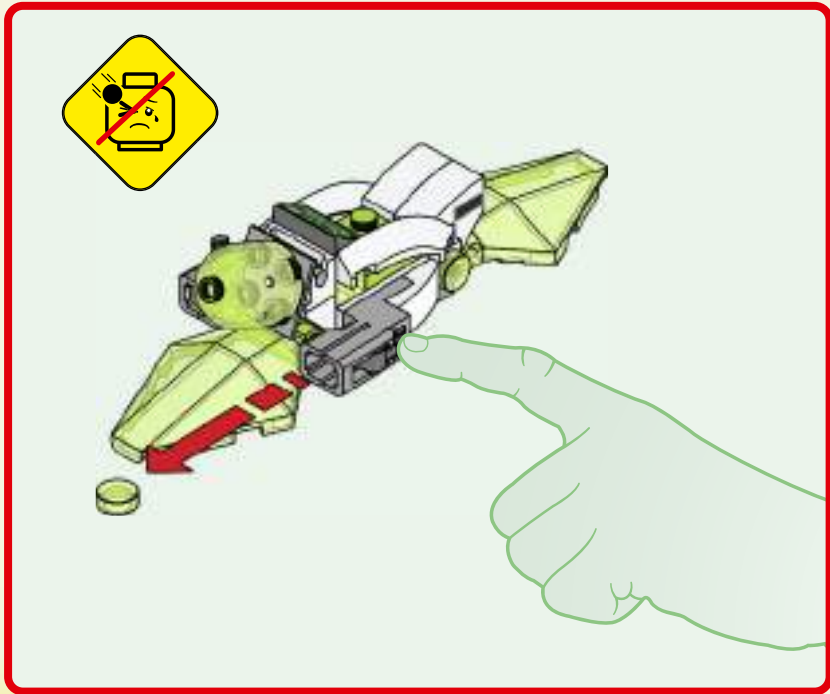



Swoosh



**LEGO**

# DREAMZZZ



**71453**



**71454**



**71455**



**71459**



**71460**



71456



71457



71458



71461



71469



Watch series online  
Schau dir die Serie online an  
Regarde la série en ligne  
Guarda la serie online  
Mira la serie en Internet  
Assistir à série online  
在线观看  
Oglądaj serial w internecie  
Sleduj serial online  
Pozri si serial online  
Nézd a sorozatot online  
Vizionează serialul online  
Глядите сериала онлайн  
Skaties seriālu tiešsaistē  
Vaata sarja veebist  
Žiūrėk serialą internetu



**LEGO**



**DREAMZZZ**



**WATCH  
SERIES  
ONLINE**



**LEGO.com/DREAMZZZ**



Rebuild  
the  
world™





1x  
6443399



1x  
4162916



2x  
4206482



1x  
4529237



1x  
6434257



3x  
6135494



1x  
6134252



1x  
6376752

102



1x  
6284587



4x  
6437507



4x  
6328192



4x  
6177349



4x  
4519195



6x  
6103415



2x  
6207783



1x  
6434196



2x  
6347293



2x  
6430887



2x  
6051511



1x  
393701



4x  
6034044



4x  
6372037



2x  
6168618



1x  
6434219



1x  
6444464



1x  
6434207



1x  
6434220



1x  
6434200



1x  
614324



1x  
6135186



1x  
379501



1x  
6131572



2x  
6284070



2x  
4286267



4x  
4558954



3x  
6335388



2x  
6335317



4x  
6209519



1x  
6444495



2x  
4548180



1x  
6195325



2x  
6280097



3x  
302326



3x  
6195185



1x  
4225201



4x  
4213374



3x  
6053077



12x  
302226



2x  
300326



4x  
6432442



4x  
6305216



2x  
4604304



1x  
6338171



3x  
6360825



1x  
4560182



2x  
6039194



4x  
6105963



1x  
6172984



3x  
366626



4x  
379526



1x  
244526

3

2x  
6227897

2x  
6313114

2x  
4654582

2x  
6326478

1x  
4211881

2x  
6360382

1x  
4211395

1x  
4211406

10x  
6343976

6x  
6168647

1x  
4211483

1x  
6251308

2x  
6248078

1x  
4210700

2x  
6360675

4x  
6221607

4x  
6296892

4x  
6439040

6x  
6199549

1x  
6194290

1x  
6434202

3x  
6395363

2x  
6336990

2x  
6302647

4x  
6398662

2x  
6178919

8x  
6029948

2x  
6215212

4x  
6308045

1x  
6350292

1x  
4211043

1x  
6214214

6x  
6276869

1x  
6037634

2x  
6423977

2x  
6167034

6x  
6274748

1x  
6434203

1x  
6244911

2x  
6423004

1x  
6443372

4x  
6347285

1x  
4537937

1x  
6440804

6x  
6275487

10x  
6267417

 [LEGO.com/service](https://LEGO.com/service)



YOU COULD  
**WIN**



Scan this QR code or go to  
**LEGO.COM/PRODUCTFEEDBACK** and give  
us your short feedback about this LEGO® set  
for a chance to win a cool LEGO prize.

Terms and Conditions apply\*



**EN: YOU COULD WIN.** Terms and Conditions apply\* **DE: Du könntest GEWINNEN.** Es gelten die Teilnahmebedingungen\* **FR: Tu pourrais GAGNER.** Des conditions s'appliquent\* **IT: Potresti VINCERE tu.** Termini e condizioni sono applicabili\* **ES: Puedes GANAR.** Aplican términos y condiciones\* **PT: Poderá GANHAR.** Aplicam-se termos e condições\* **ZH: 轻松获奖. 条款和条件适用\*** **PL: Szansa na WYGRANĄ.** Obowiązują warunki korzystania\* **CS: Máte šanci VYHRÁT.** Platí všeobecné smluvní podmínky\* **SK: Máte šancu VYHRÁŤ.** Platia všeobecné zmluvné podmienky\* **HU: TE IS NYERHETSZ.** Felhasználási feltételek érvényesek\* **RO: Ai putea CÂȘTIGA.** Se aplică termenii și condiții\* **BG: Можете да СПЕЧЕЛИТЕ.** Има определени правила и условия\* **LV: Tu vari LAIMĒT.** Ir spēkā noteikumi un nosacījumi.\* **ET: Sul on võimalus VÕITA.** Kehtivad tingimused\* **LT: Jūs galite LAIMĖTI.** Taikomos sąlygos\*

\*[LEGO.com/productfeedback-terms](https://www.lego.com/productfeedback-terms)