



DREAMZZZ

71454





LEGO.com/sustainable-packaging

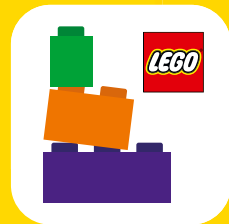

BUILDER



Apple and the Apple logo are trademarks of Apple Inc., registered in the U.S. and other countries and regions. App Store is a service mark of Apple Inc. Google Play and the Google Play logo are trademarks of Google LLC. Tencent and the Tencent logo are trademarks of Tencent Inc.

Q [LEGO.com/devicecheck](https://www.lego.com/devicecheck)

EN Ask parents' permission before going online | **DE** Eltern um Erlaubnis bitten, bevor du online gehst | **FR** Demande l'autorisation d'un parent avant d'aller en ligne | **IT** Chiedi il permesso ai tuoi genitori prima di andare online | **ES** Pídeles permiso a tus papás antes de conectarte a Internet | **PT** Peça autorização aos pais antes de acederes online | **ZH** 上网前应先征得父母的同意 | **PL** Poproś rodziców o zgodę, zanim wejdiesz do Internetu | **CS** Než půjdeš na internet, požádej rodiče o svolení | **SK** Skôr než pôjdeš na internet, vypýtaj si povolenie od rodičov | **HU** Kérj szülői engedélyt, mielőtt online csatlakoznál! | **RO** Cere permisiunea părinților înainte de a te conecta online | **BG** Поискайте разрешение от родител, преди да влезете онлайн | **LV** Pirms došanās tiešsaistē palūdz atļauju vecākiem | **ET** Enne Interneti kasutamist küsi vanematelt luba | **LT** Prieš prisijungdami prie interneto, atsiklauskite tėvų





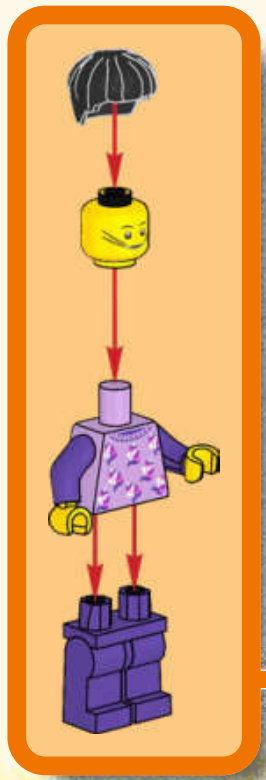



1

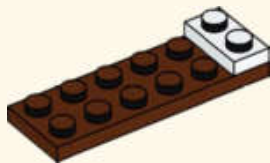

2





1x



1x

3



4





N
N
N



1x



1x

1





1x

2



1x

3





4x

4



1x

5





2x

6



4x



4x

7

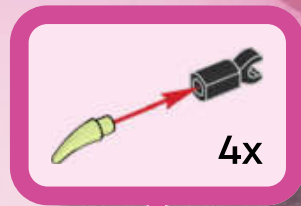



8

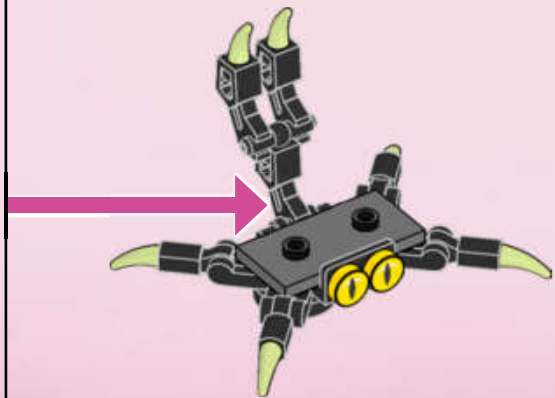
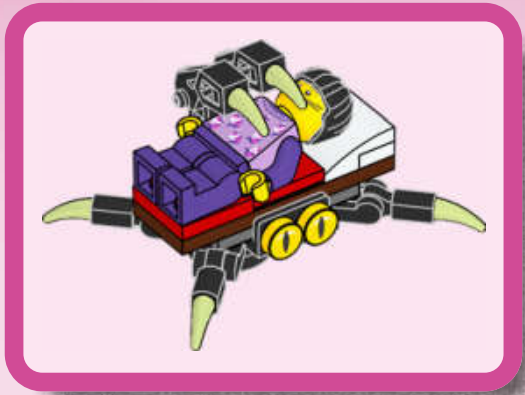
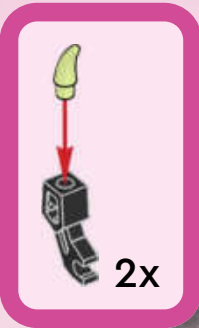
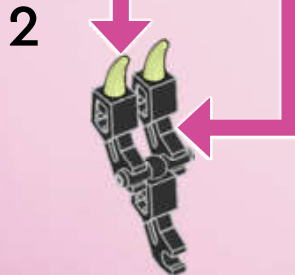



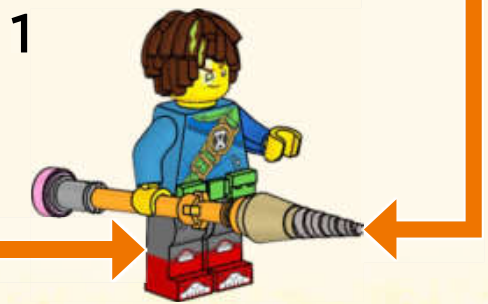
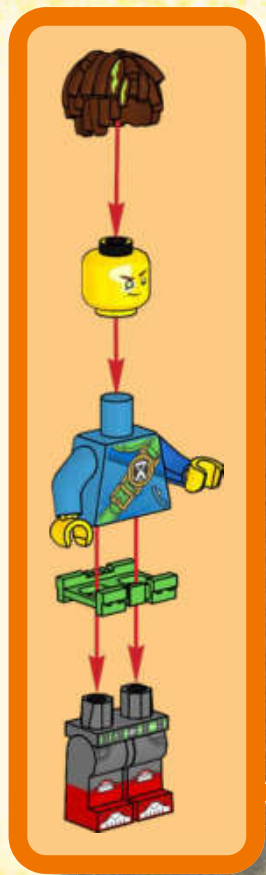

2



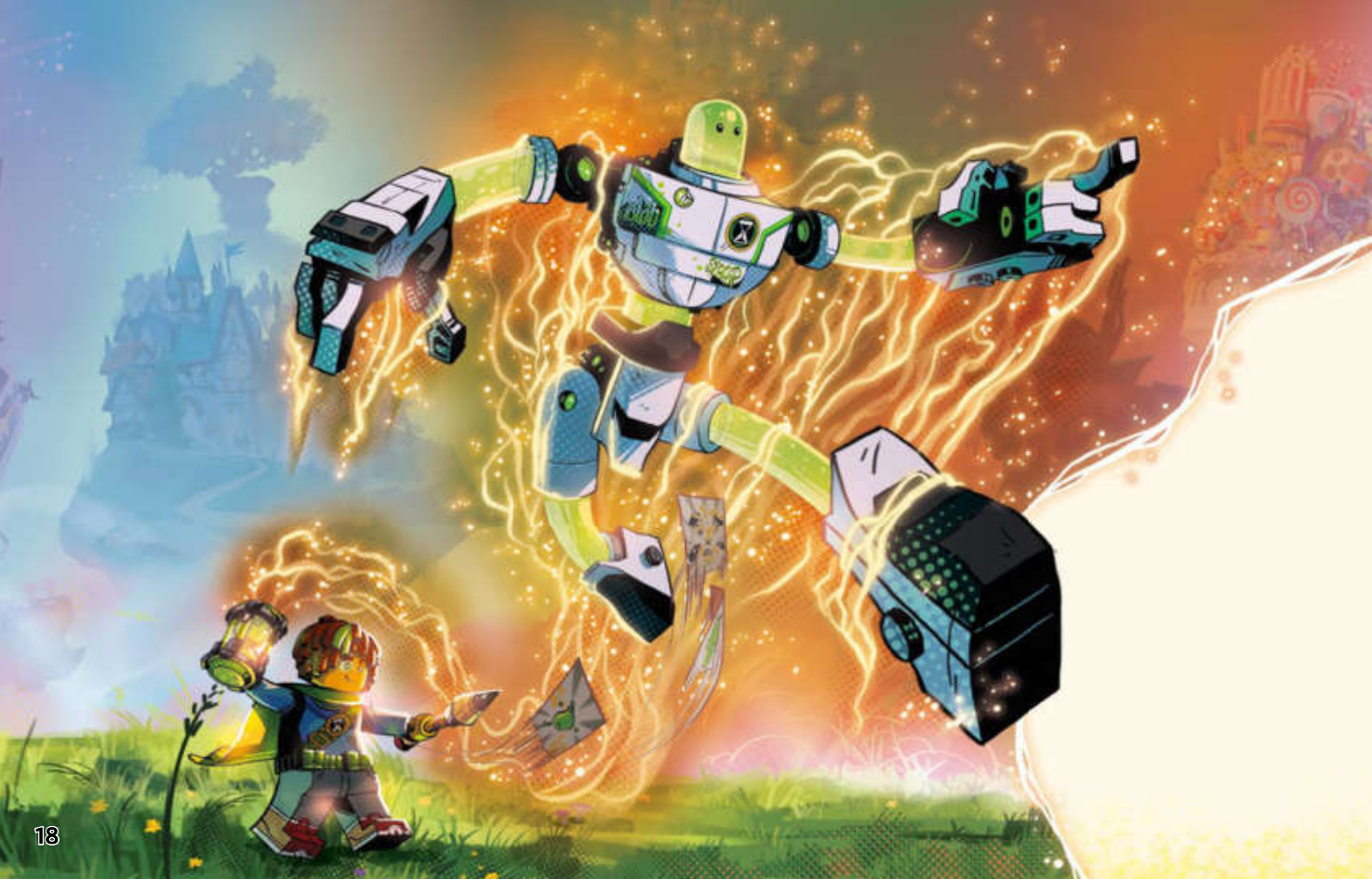



1x



1x

1

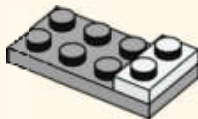

1x

2

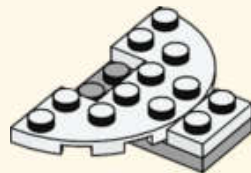



1x

3

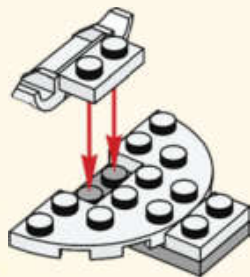

1x



2x

4





1x



1x

5



1x



1x

6





2x



2x

7

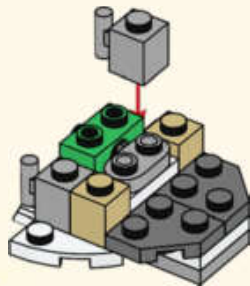

2x

8

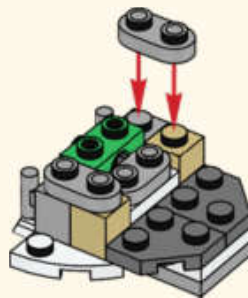



1x

9

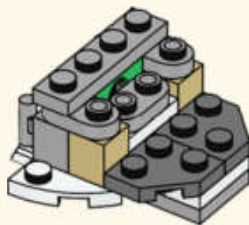

2x

10

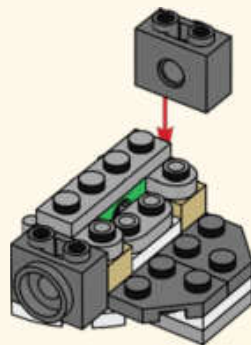



1x



1x

11

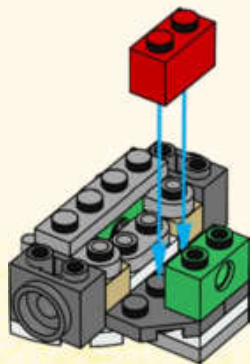

2x



2x

12

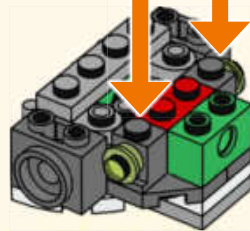

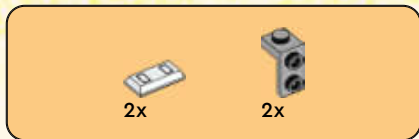

13

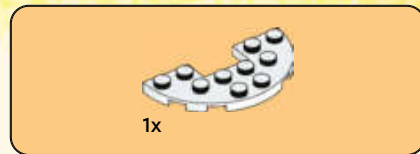
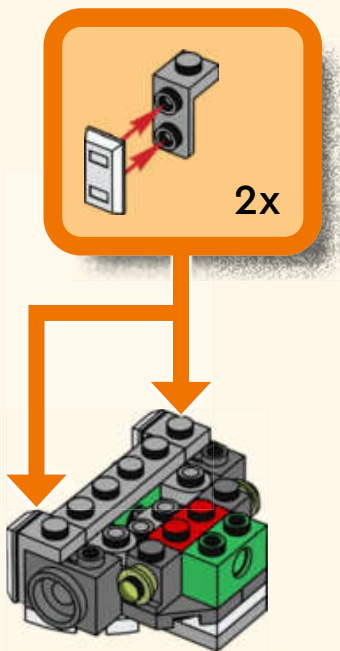

14

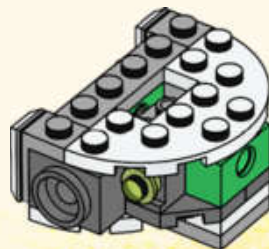



15

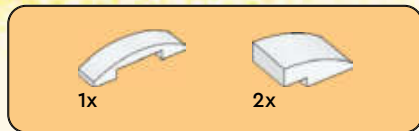
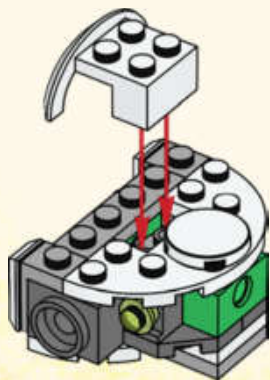

16

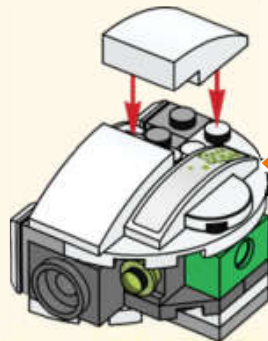
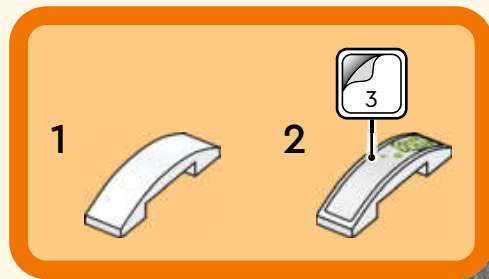

17

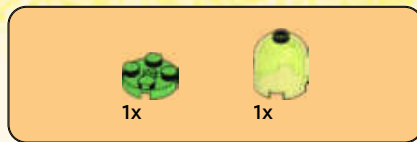
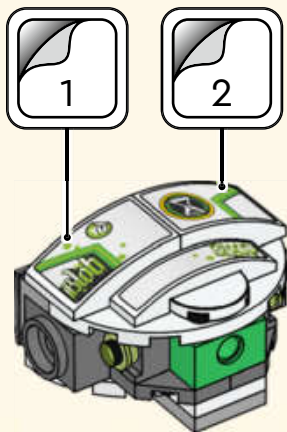

18

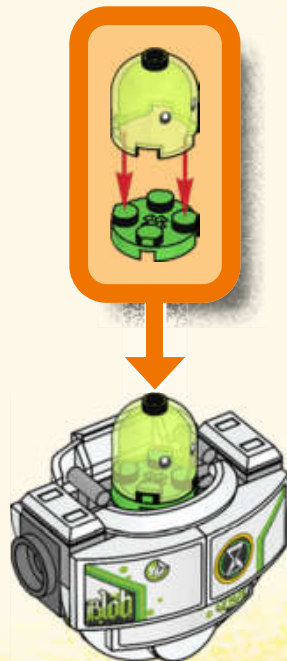



19

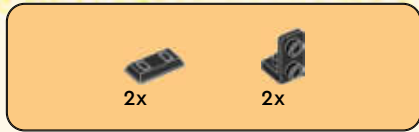

20

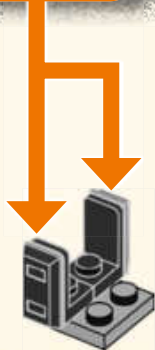
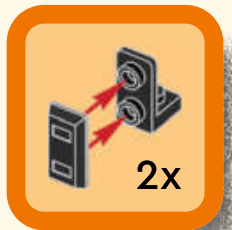



1x

21



2x

22



1x



1x

23

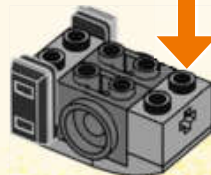



1x

24



1x



1x

25



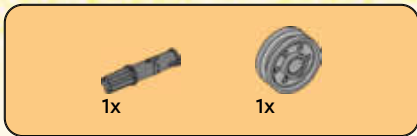

26

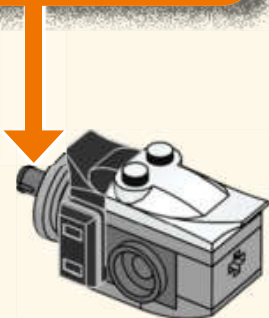
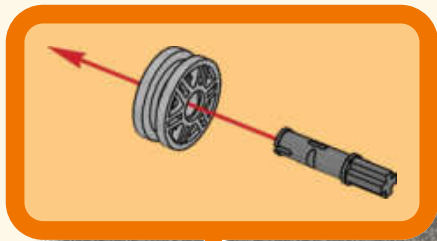

27

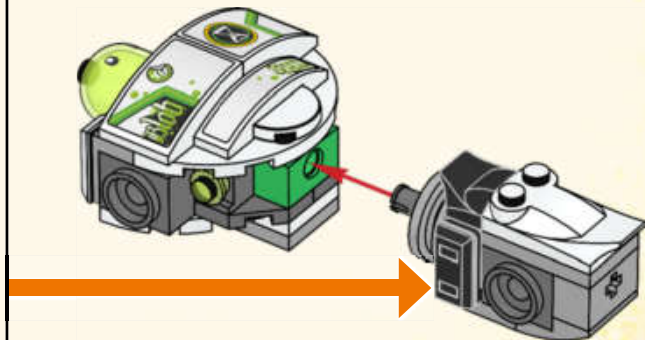

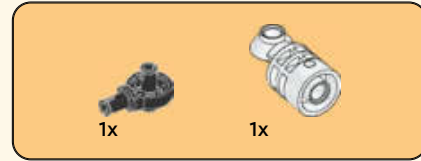

28

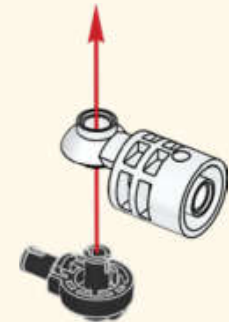



1x

29

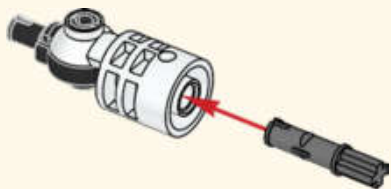

1x

30

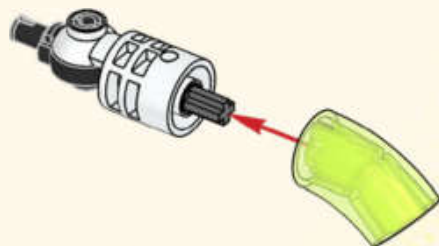

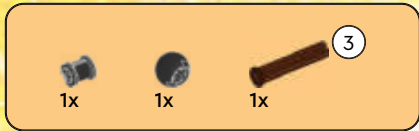

31

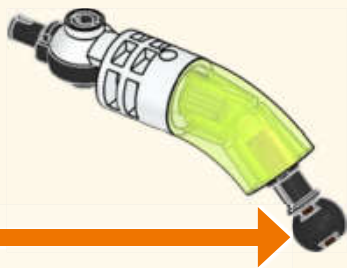
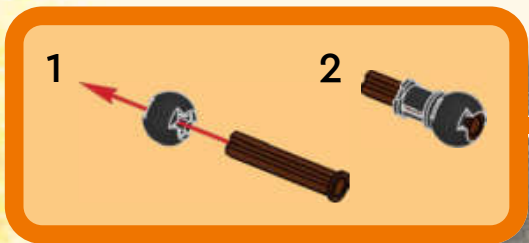

2x

32

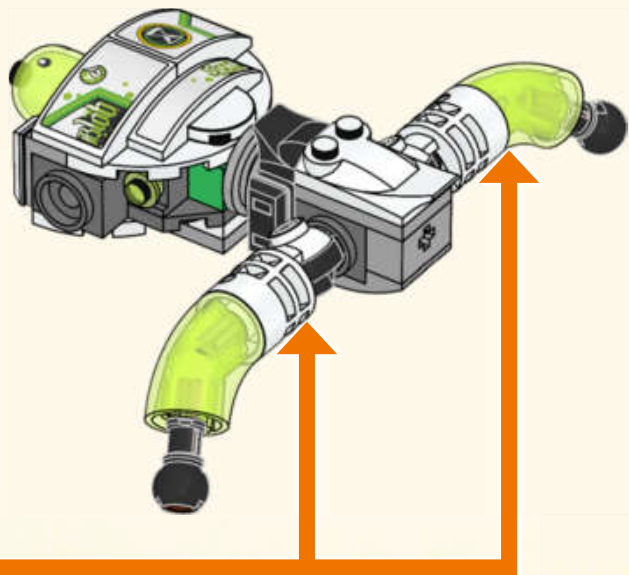

33

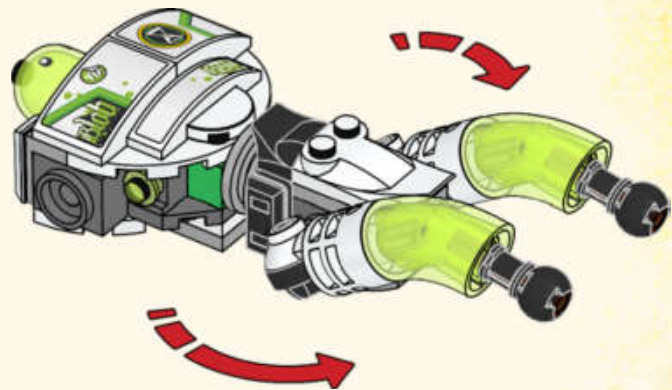



2x



1x



1x

34

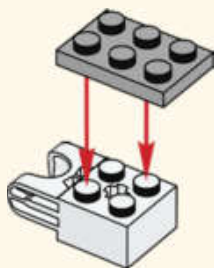

1x

35

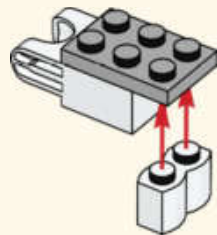



1x

36

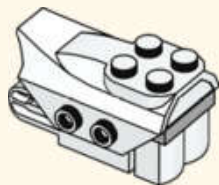

2x

37

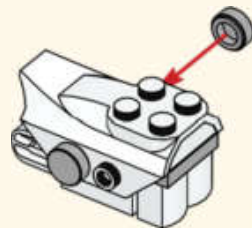



1x

38

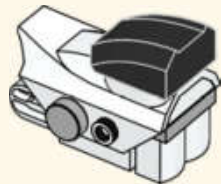

1x

39

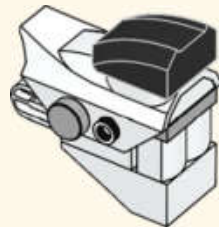

2x

40

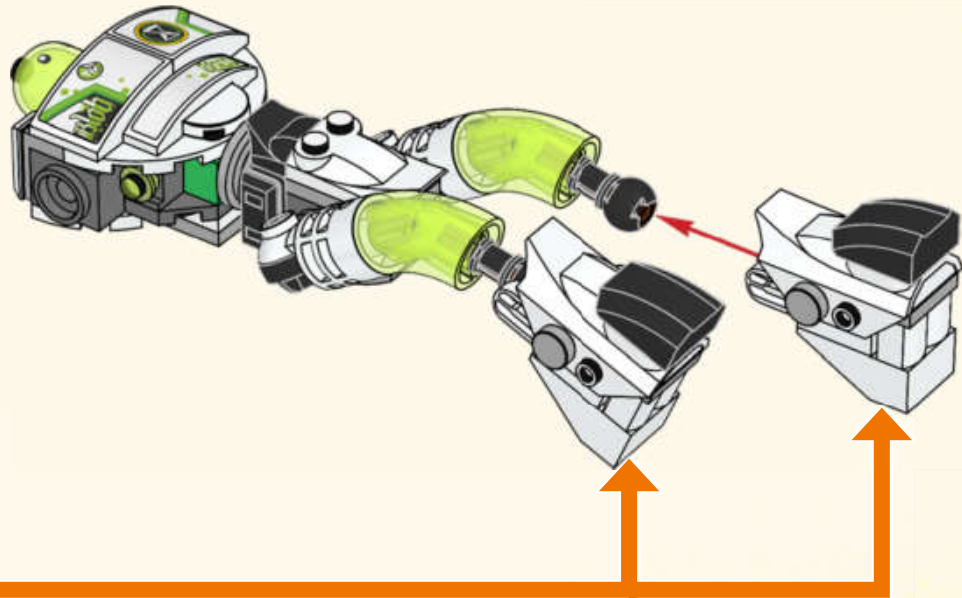



2x



1x



1x

41

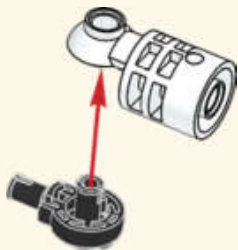

1x

42

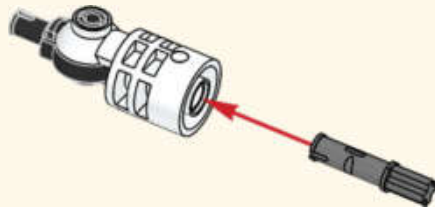



1x

43



1x

44



2x

45

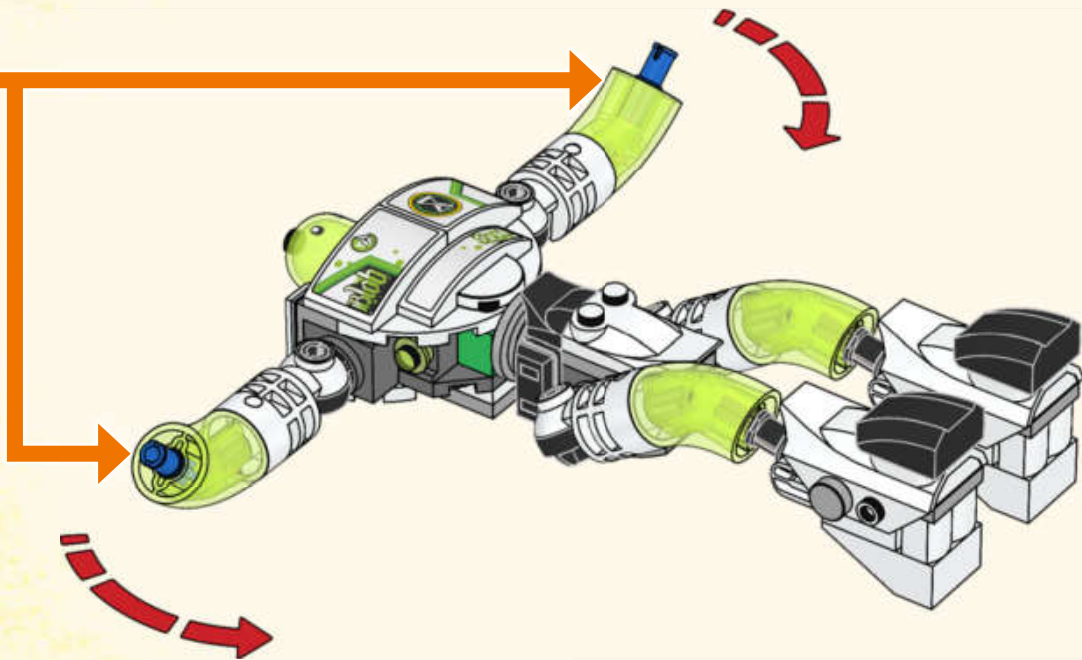

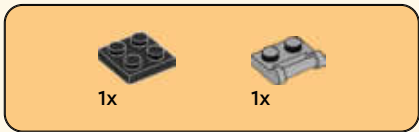

46



47

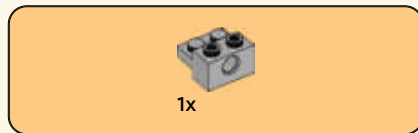

48

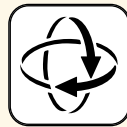



1x

49

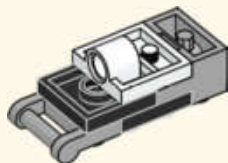

1x

50

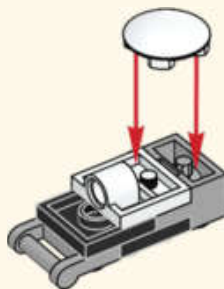



51

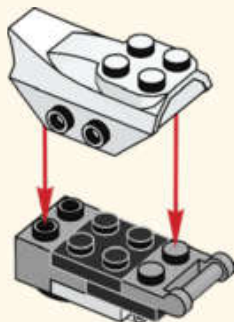

52

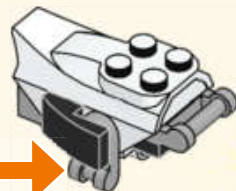



3x

53

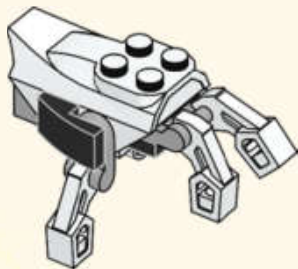

54

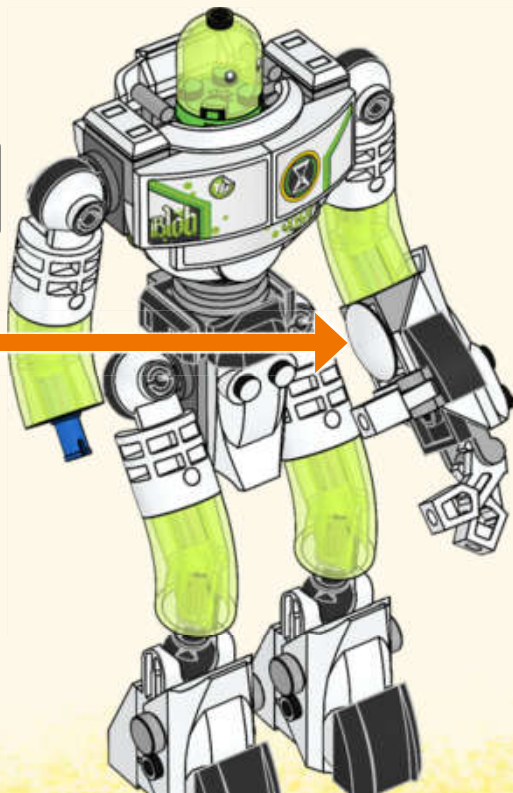



1x



1x

55



1x

56





1x

57

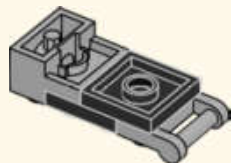

1x

58

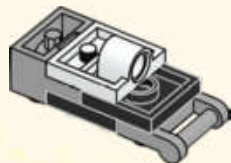

1x

59

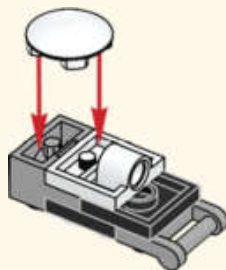



1x

60

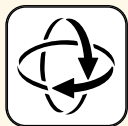

1x



1x

61

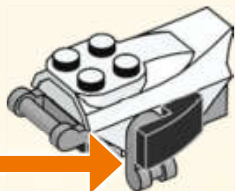

3x

62

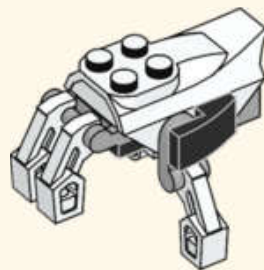

63

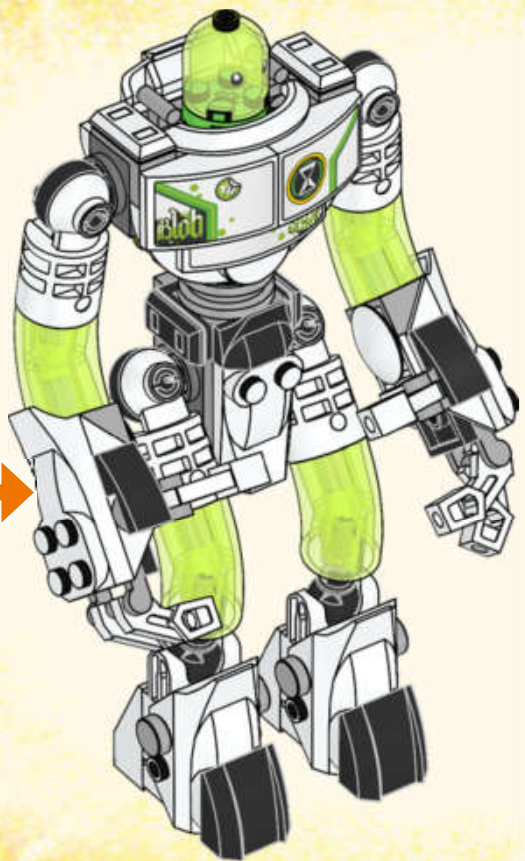



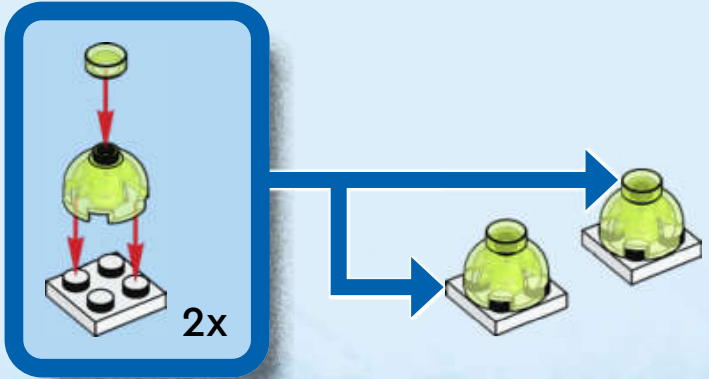

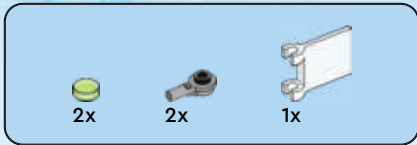

1

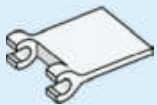

2



3

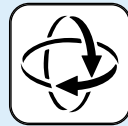

4

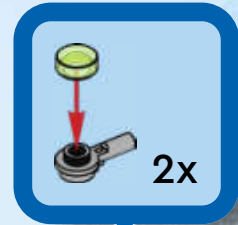
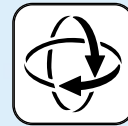

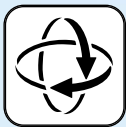

1

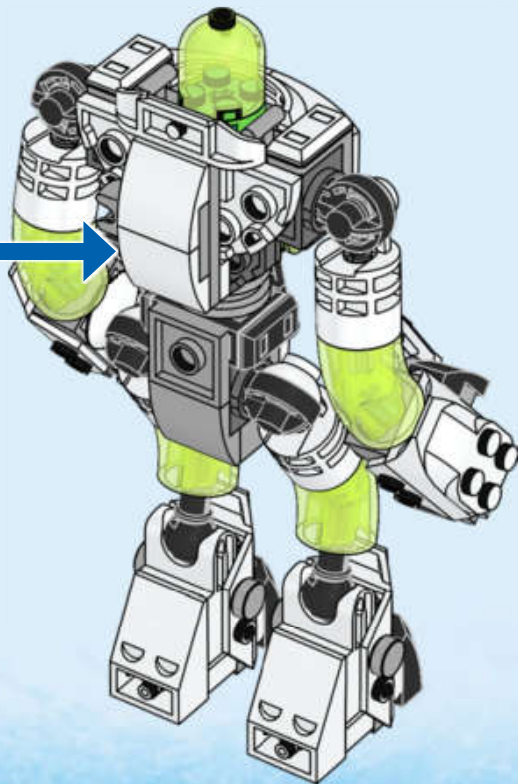
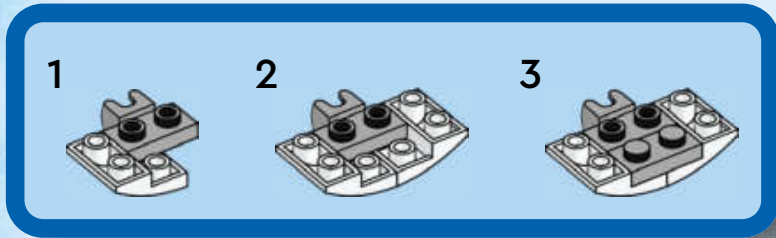

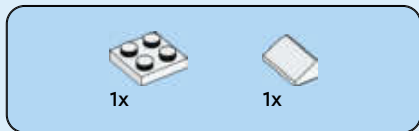
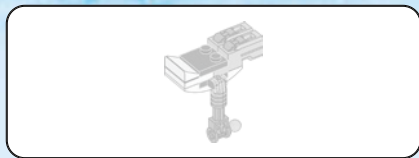

2

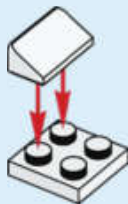

3

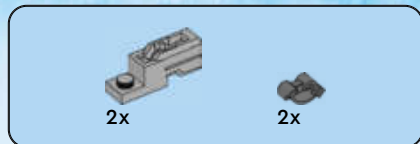

4

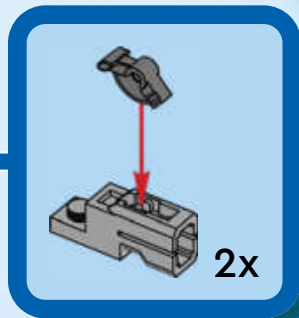
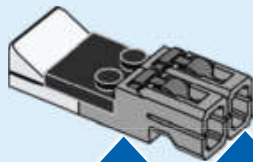



5

1

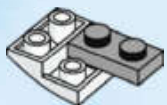

2

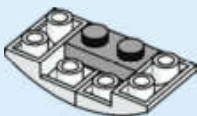

3

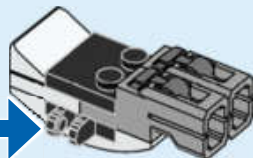
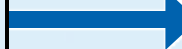

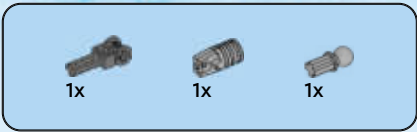

6

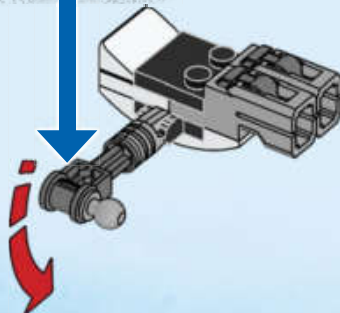
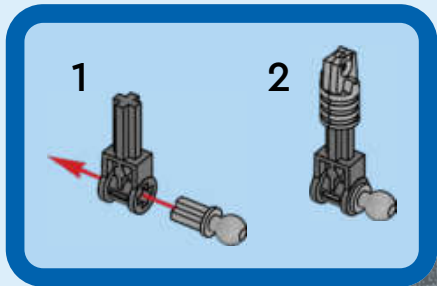

7

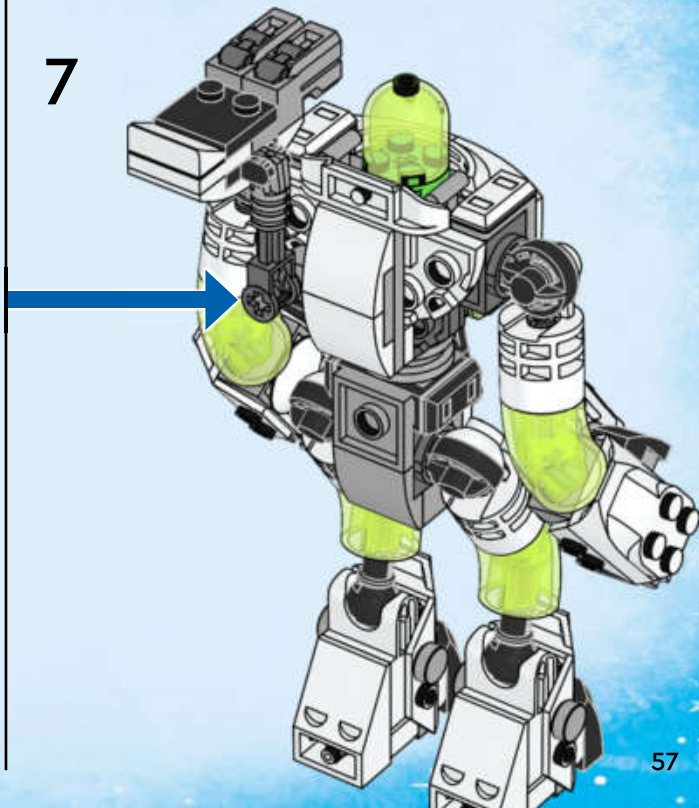



4x



8

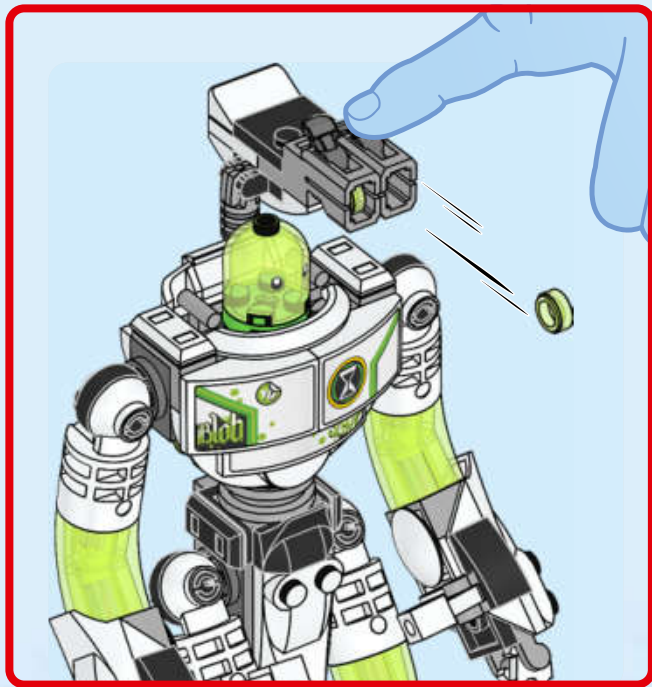
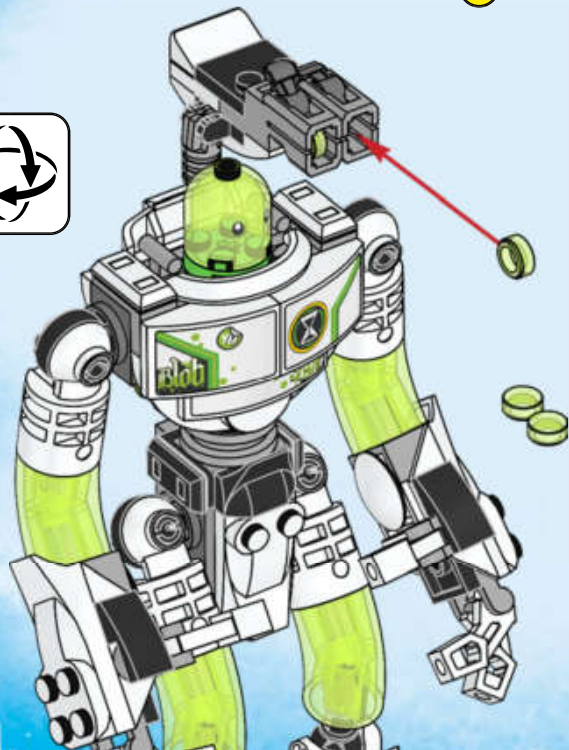



9

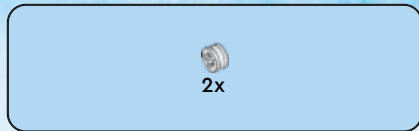

10





1x

11

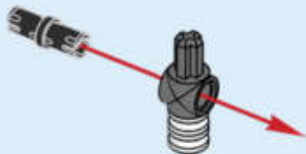

1x

12



1x

13



4

1:1



1x

14



1x

15





2x

16

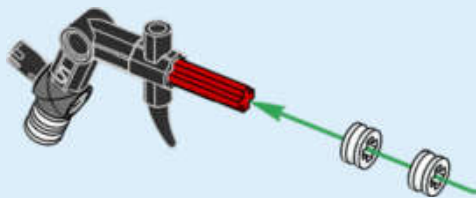

1x

17



1x

18

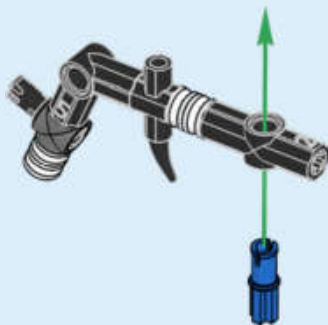

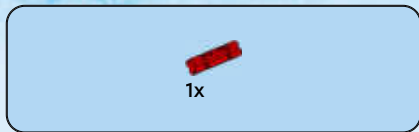

19

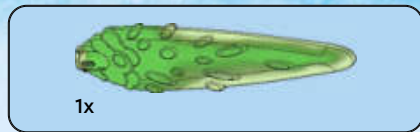

20



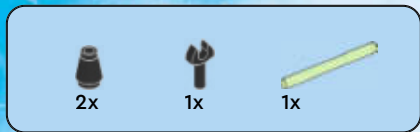

21

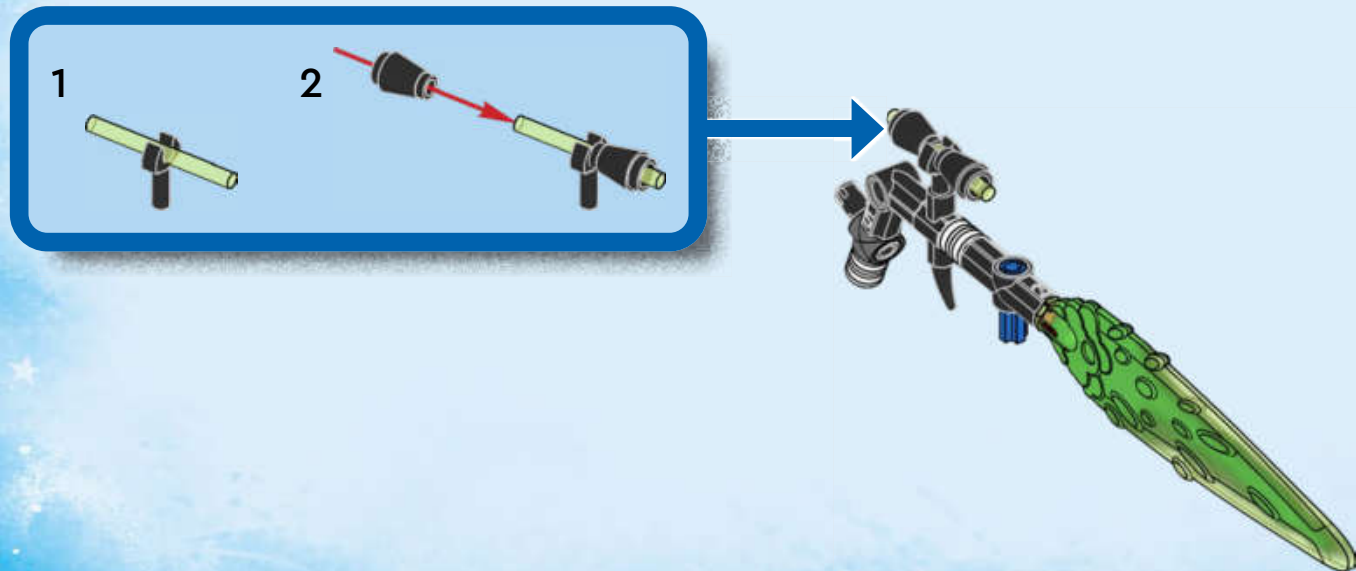

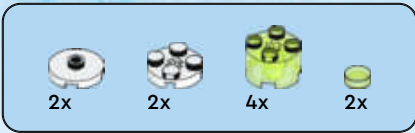

22

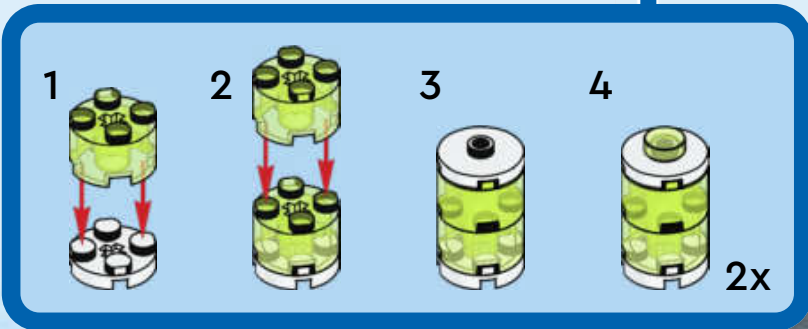

23

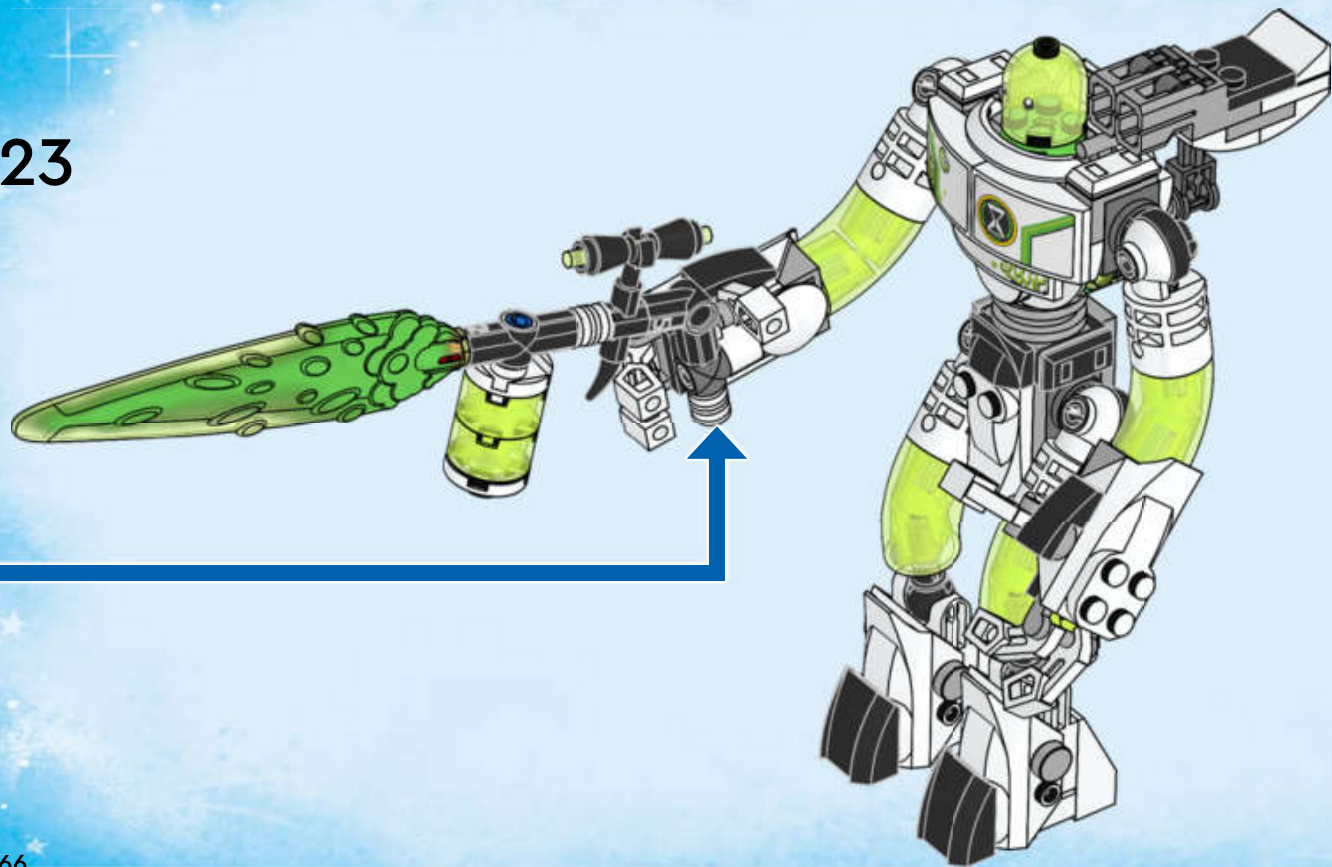



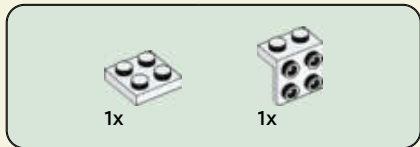

1

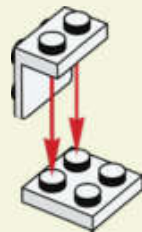



1x

2



1x

3



4x

4





2x

5

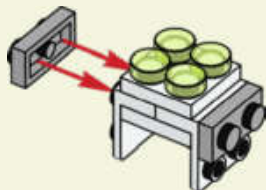

2x

6

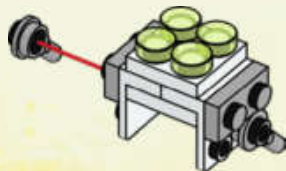

2x



2x

7

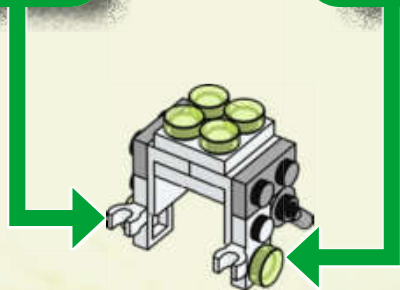

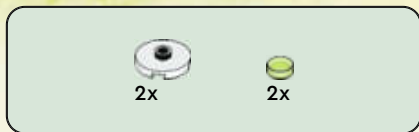

8

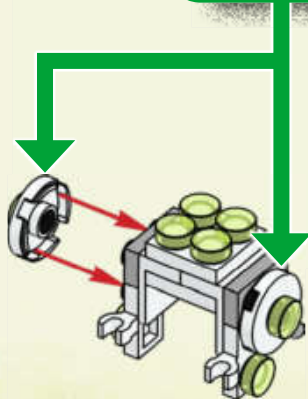
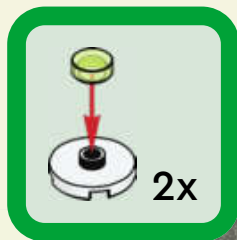

9

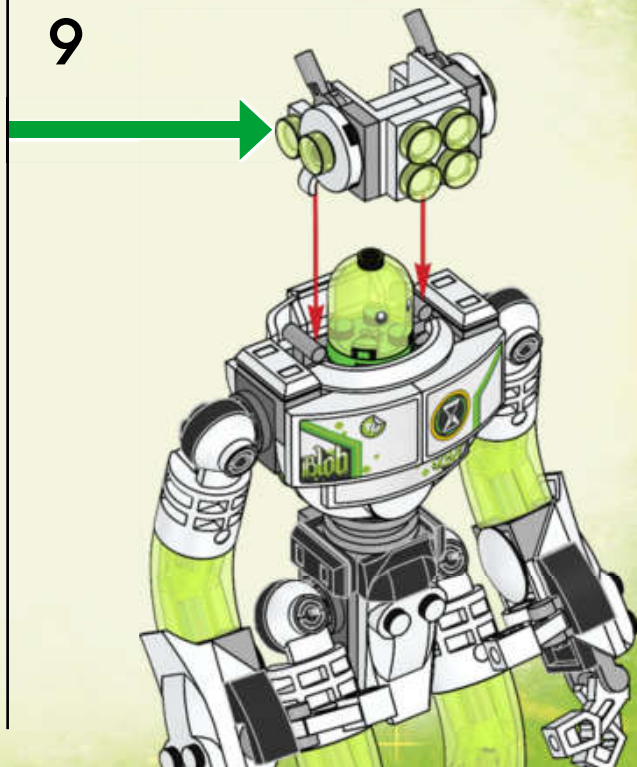

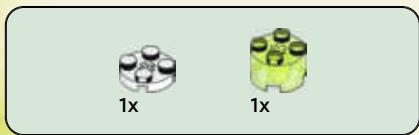

10

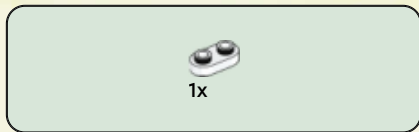

11



12





13

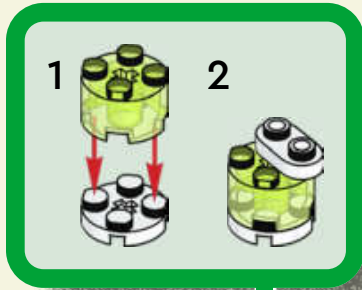

14





2x



2x

15

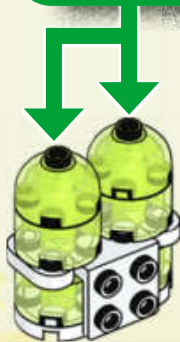
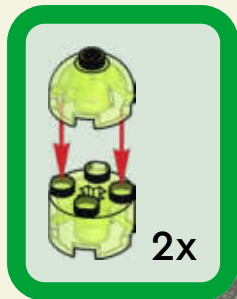

1x



1x



1x

16

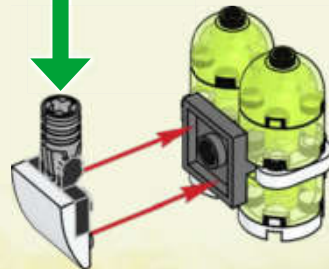
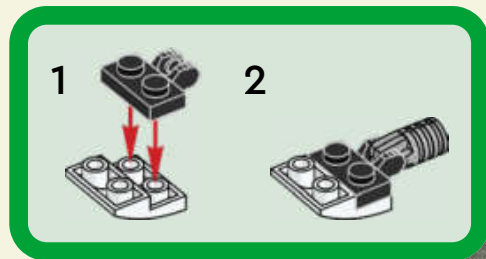

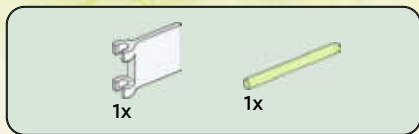

17

1

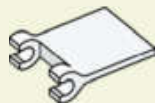

2

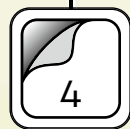

3



4





18

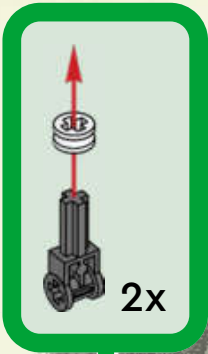

1



2

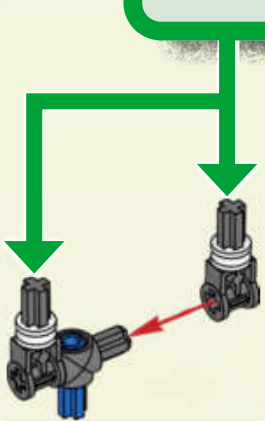

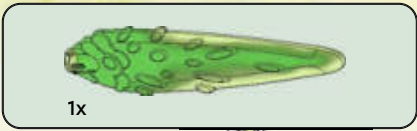

19



20

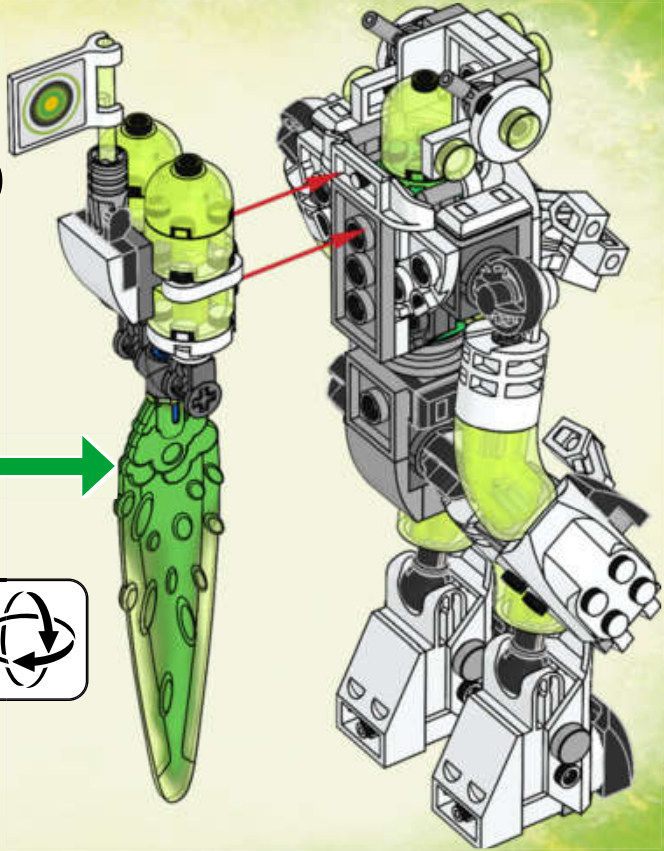
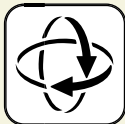
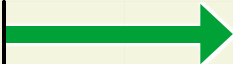



21

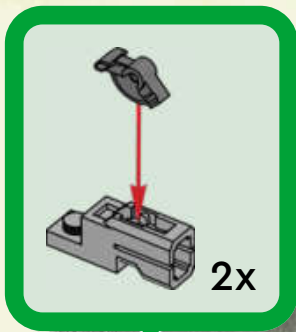

1



2

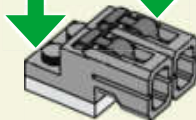

3

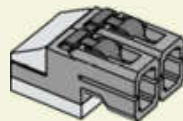

22

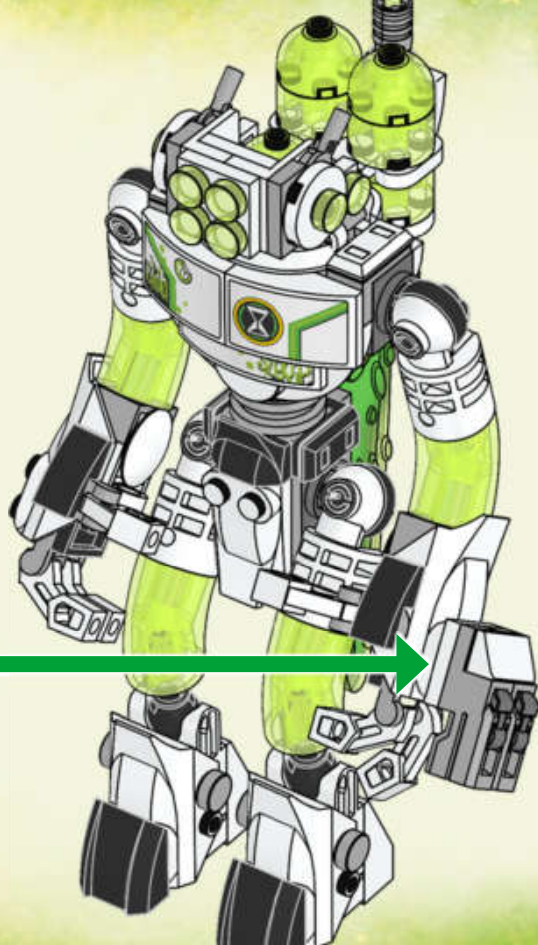

2x

23

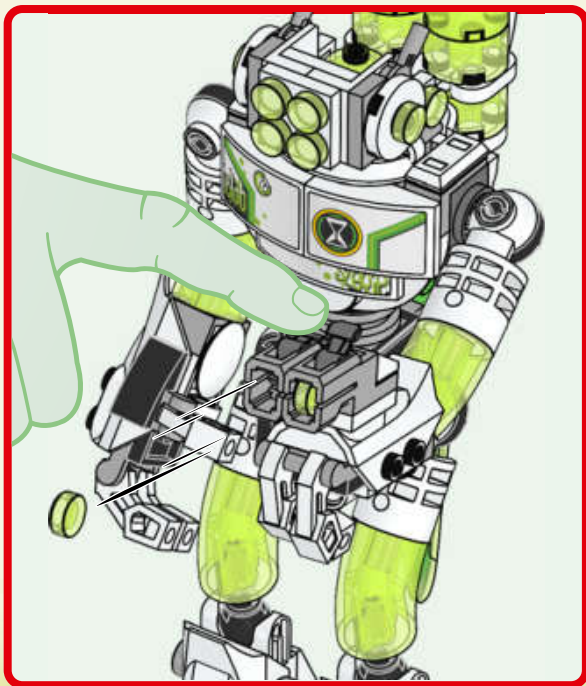
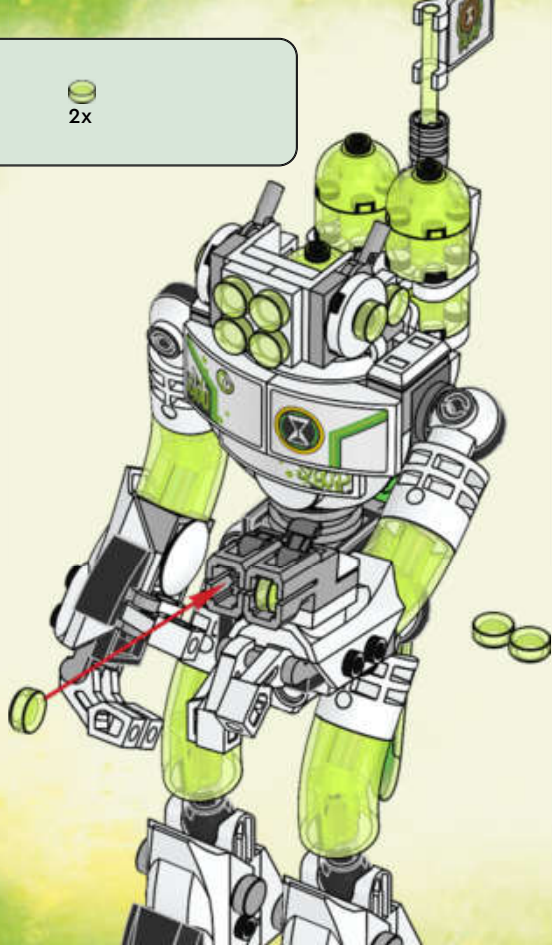





DREAMZZZ



71453



71454



71455



71459



71460



71456



71457



71458



71461



71469

Watch series online
Schau dir die Serie online an
Regarde la série en ligne
Guarda la serie online
Mira la serie en Internet
Assistir à série online
在线观看

Oglądaj serial w internecie
Sleduj seriál online
Pozri si seriál online
Nézd a sorozatot online
Vizionează serialul online
Глядите сериала онлайн
Skaties seriālu tiešsaistē
Vaata sarja veebist
Žiūrėk serialą internetu

LEGO

DREAMZZZ

WATCH
SERIES
ONLINE



LEGO.com/DREAMZZz



Rebuild
the
world™



 4x 6360263	 2x 6210076	 2x 6435932	 1x 4142865	 1x 4529237	 4x 6157554	 1x 6271346	 1x 6440804
 1x 6434196	 3x 302301	 1x 6249277	 1x 300421	 2x 4113915	 1x 6279875	 1x 4140588	 3x 4206482
 2x 6210272	 2x 6313115	 2x 6132212	 1x 6219819	 1x 6270103	 2x 403226	 4x 4213374	 1x 6134252
 1x 4547489	 3x 6117940	 1x 6170504	 1x 306821	 4x 6315887	 1x 6280097	 4x 302226	 1x 6376752
 2x 403201	 1x 6365487	 1x 4610897	 1x 6129995	 2x 4529236	 3x 6276867	 1x 6192346	 1x 6434257
 2x 4278271	 3x 302201	 1x 6023806	 1x 6129995	 1x 6439039	 2x 6047276	 2x 4143875	 2x 6135494
 1x 6044691	 2x 6061024	 2x 6360826	 1x 6129995	 2x 4286267	 1x 6266207	 1x 6271869	 1x 4211247
 2x 6093053	 4x 6210385	 4x 6365687	 1x 6434205	 2x 6332148	 2x 6156991	 2x 6230235	 4x 6284071
 2x 6059185	 1x 6047220	 2x 6192352	 1x 6434200	 2x 6335317	 1x 6375706	 1x 6138624	 1x 4211483
 6x 6276864	 4x 6428169	 2x 6192352	 2x 6434207	 1x 6405102	 1x 6020193	 1x 6443372	 2x 6170569

2x
6362975

1x
6443149

3x
6248890

1x
6265704

2x
6227897

2x
6225246

2x
4211398

1x
6043656

2x
6206249

1x
6044729

2x
4244627

2x
6326478

2x
4211397

1x
6185676

2x
6360382

2x
4211396

1x
4211445

2x
4211395

1x
6284587

1x
6395635

2x
4211044

2x
6360675

1x
6434202

4x
6398662

2x
6164073

2x
4210665

1x
6250018

1x
6167281

5x
6015356

1x
6307616

1x
4586410

12x
6274748

2x
6240206

2x
6435761

1x
6434203

4x
6296849

1x
6430885

1x
6258883

4x
6430877

1x
6214214

1x
6443399

1x
6443370

6x
6275487

 [LEGO.com/service](https://www.LEGO.com/service)



**YOU COULD
WIN**



Scan this QR code or go to
LEGO.COM/PRODUCTFEEDBACK and give
us your short feedback about this LEGO® set
for a chance to win a cool LEGO prize.

Terms and Conditions apply*

EN: YOU COULD WIN. Terms and Conditions apply* **DE: Du könntest GEWINNEN.** Es gelten die Teilnahmebedingungen* **FR: Tu pourrais GAGNER.** Des conditions s'appliquent* **IT: Potresti VINCERE tu.** Termini e condizioni sono applicabili* **ES: Puedes GANAR.** Aplican términos y condiciones* **PT: Poderá GANHAR.** Aplicam-se termos e condições* **ZH: 轻松获奖. 条款和条件适用*** **PL: Szansa na WYGRANĄ.** Obowiązują warunki korzystania* **CS: Máte šanci VYHRÁT.** Platí všeobecné smluvní podmínky* **SK: Máte šancu VYHRÁŤ.** Platia všeobecné zmluvné podmienky* **HU: TE IS NYERHETSZ.** Felhasználási feltételek érvényesek* **RO: Ai putea CÂȘTIGA.** Se aplică termenii și condiții* **BG: Можете да СПЕЧЕЛИТЕ.** Има определени правила и условия* **LV: Tu vari LAIMĒT.** Ir spēkā noteikumi un nosacījumi.* **ET: Sul on võimalus VÕITA.** Kehtivad tingimused* **LT: Jūs galite LAIMĖTI.** Taikomos sąlygos*

*[LEGO.com/productfeedback-terms](https://www.lego.com/productfeedback-terms)