



NINJAGO

DRAGONS RISING

71791





 **FR**
DONNEZ
OU
RECYCLEZ

 OU  OU 

ASSOCIATION MAGASIN DÉCHÈTERIE

Adresses sur quefairedemesdechets.fr



LEGO.com/sustainable-packaging

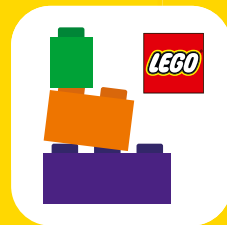

BUILDER



Apple and the Apple logo are trademarks of Apple Inc., registered in the U.S. and other countries and regions. App Store is a service mark of Apple Inc.

Google Play and the Google Play logo are trademarks of Google LLC.

Tencent and the Tencent logo are trademarks of Tencent Inc.

Q [LEGO.com/devicecheck](https://www.lego.com/devicecheck)

EN Ask parents' permission before going online | **DE** Eltern um Erlaubnis bitten, bevor du online gehst | **FR** Demande l'autorisation d'un parent avant d'aller en ligne | **IT** Chiedi il permesso ai tuoi genitori prima di andare online | **ES** Pídeles permiso a tus papás antes de conectarte a Internet | **PT** Pede autorização aos pais antes de acederes online | **ZH** 上网前应先征得父母的同意 | **PL** Poproś rodziców o zgodę, zanim wejdiesz do Internetu | **CS** Než půjdeš na internet, požádej rodiče o svolení | **SK** Skôr než pôjdeš na internet, vypýtaj si povolenie od rodičov | **HU** Kérj szülői engedélyt, mielőtt online csatlakoznál! | **RO** Cere permisiunea părinților înainte de a te conecta online | **BG** Поискайте разрешение от родител, преди да влезете онлайн | **LV** Pirms došanās tiešsaistē palūdz atļauju vecākiem | **ET** Enne Interneti kasutamist küsi vanematelt luba | **LT** Prieš prisijungdami prie interneto, atsiklauskite tėvų

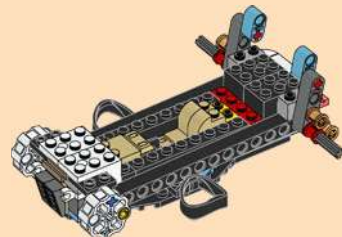
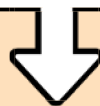

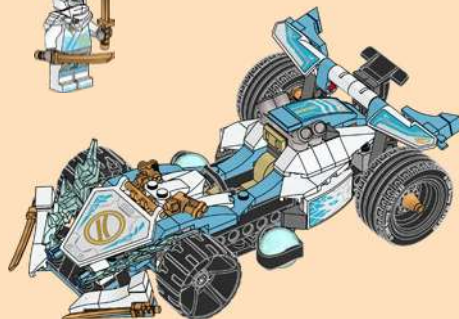
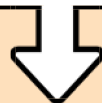
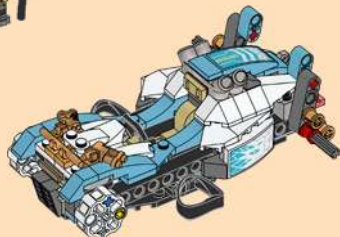
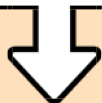



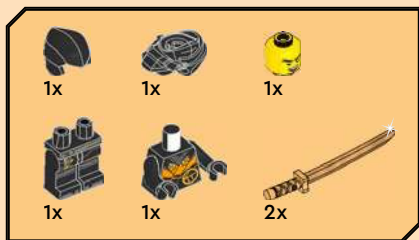

1



2



3



4



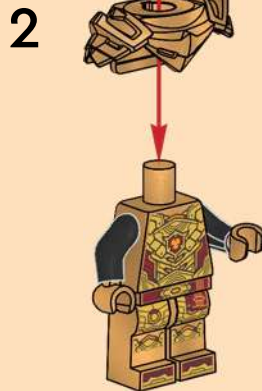
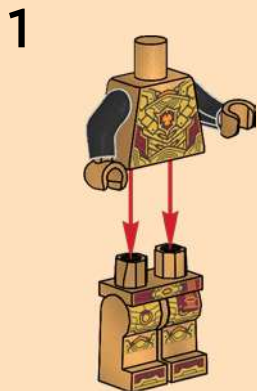
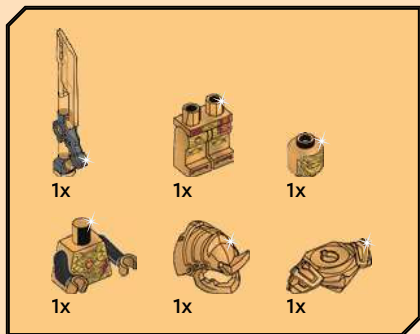



1

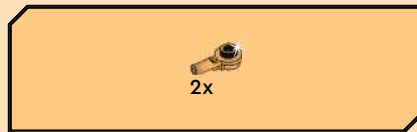

2





3



4



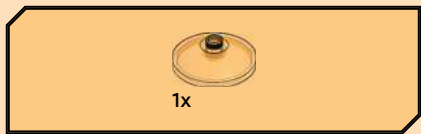

5



6





7

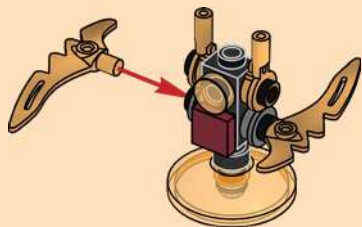

8

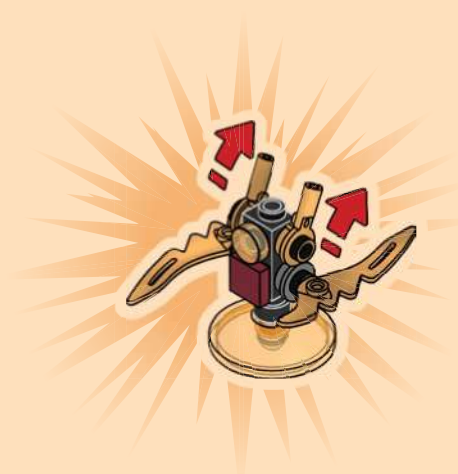



2x



1x

1



1x

2





3

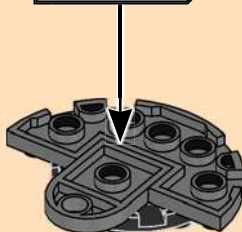

4



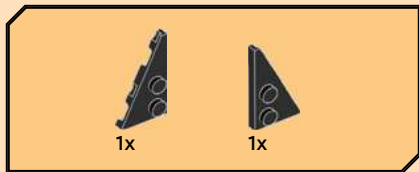

5



6



7

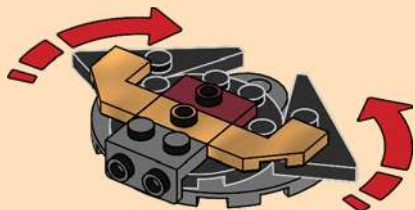

8

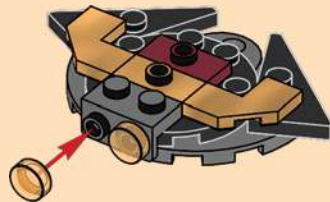
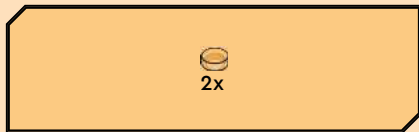



9

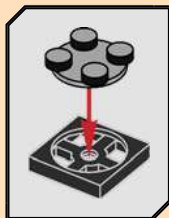
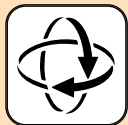

10

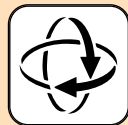



11

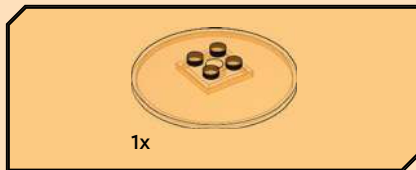

12

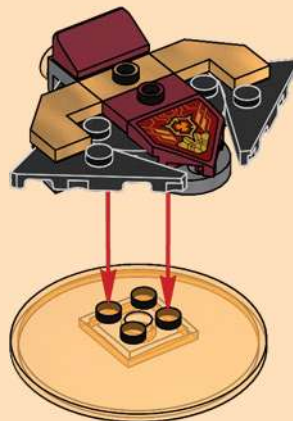

2x







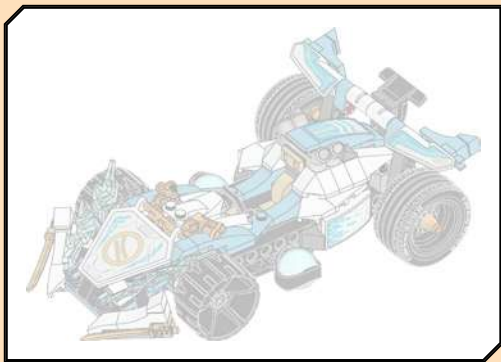

1



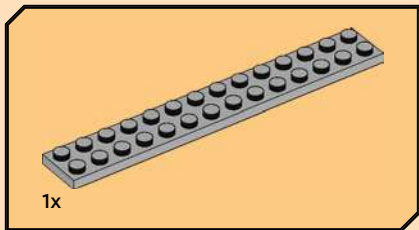

2

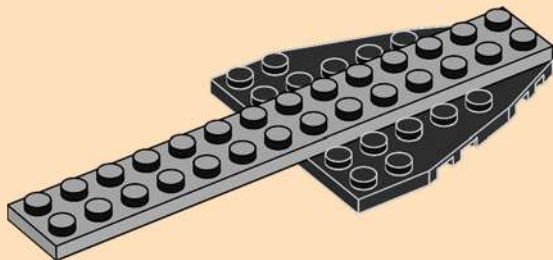

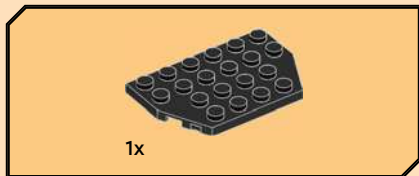

3

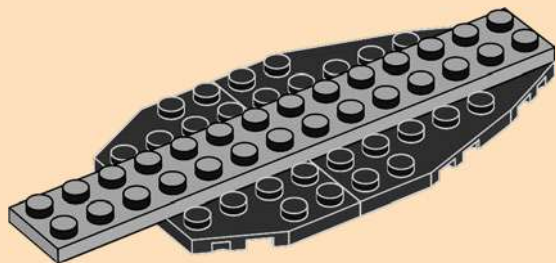

4

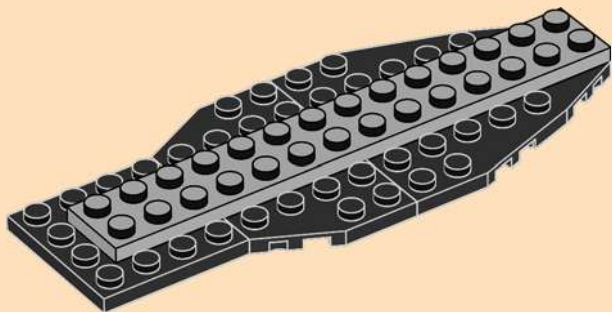



1x

5

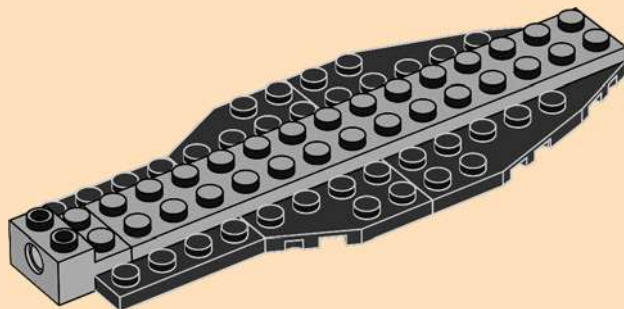

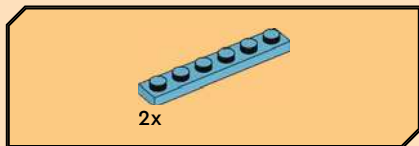

6

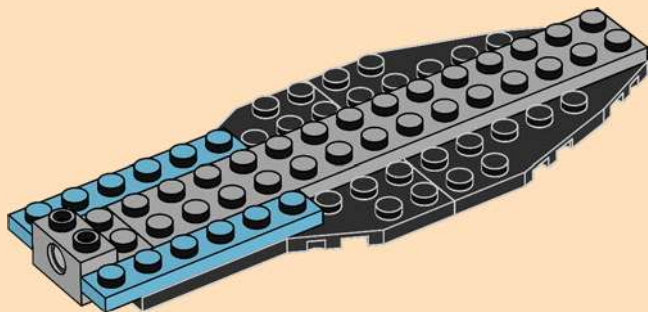

7

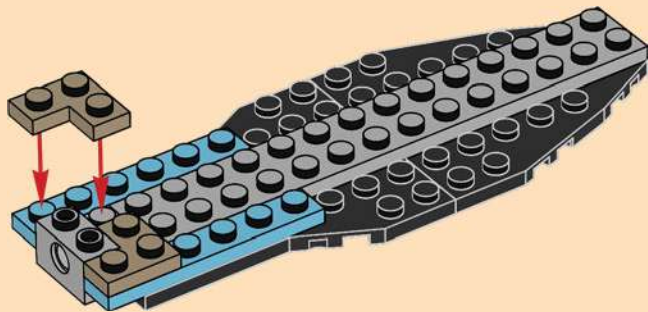

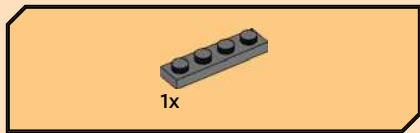

8

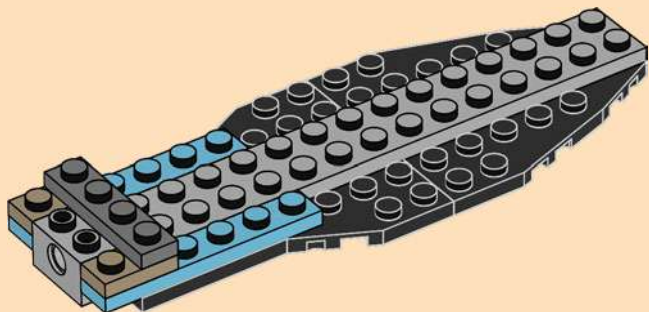

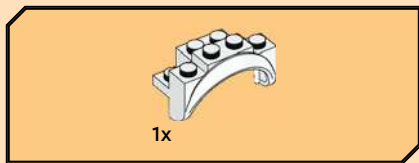

9

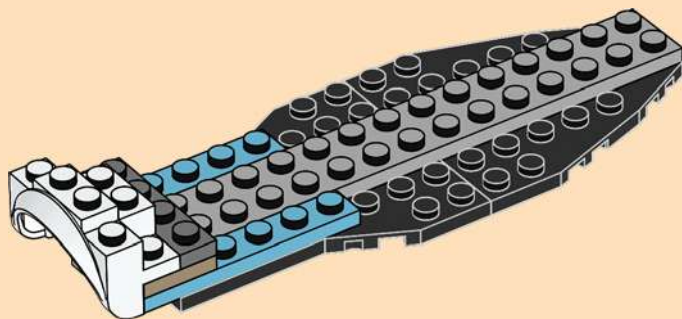



2x

10

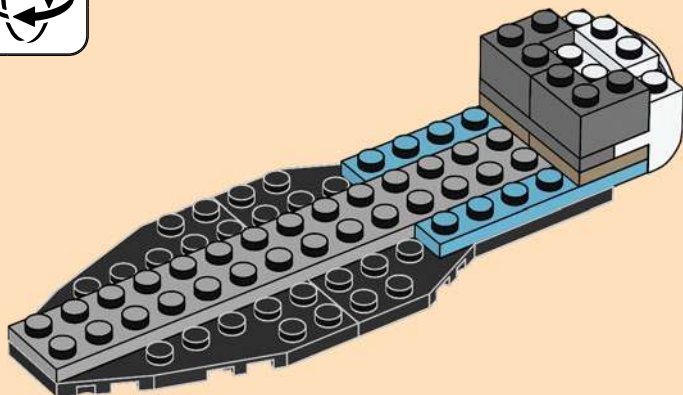
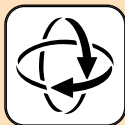



3x

11

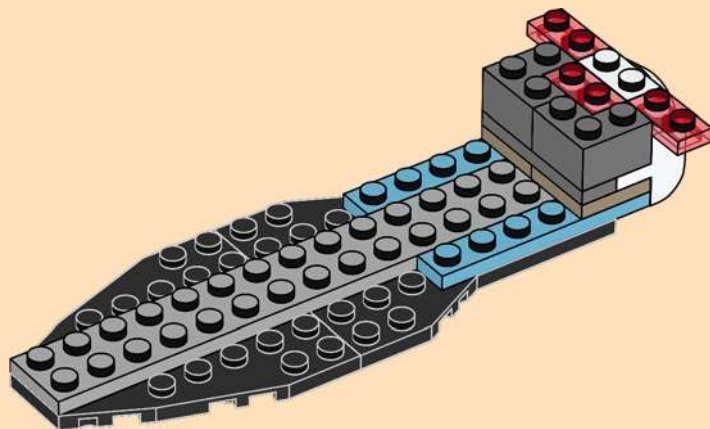



2x

12

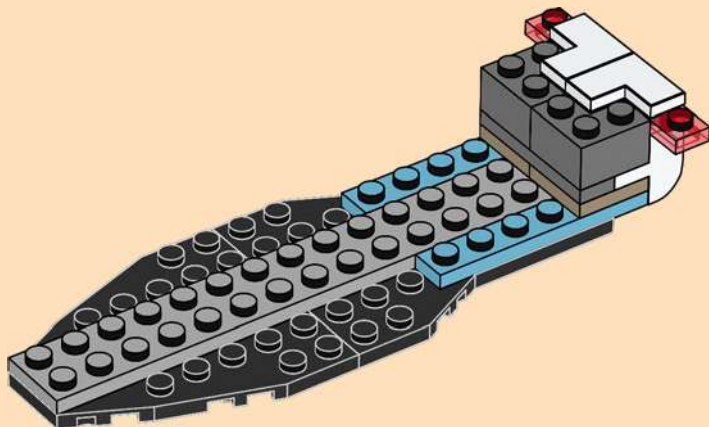



13

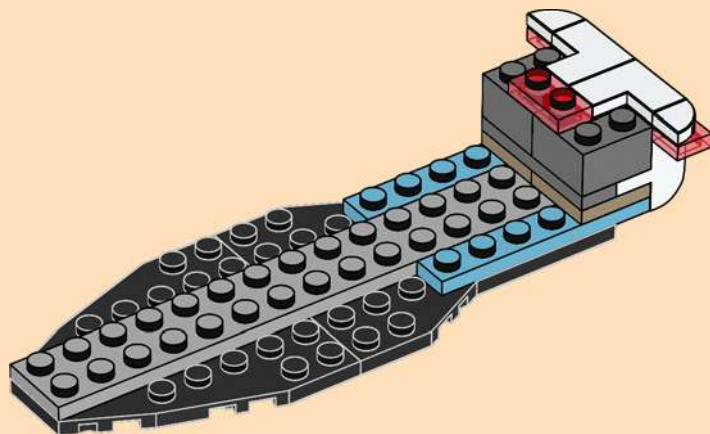



2x

14

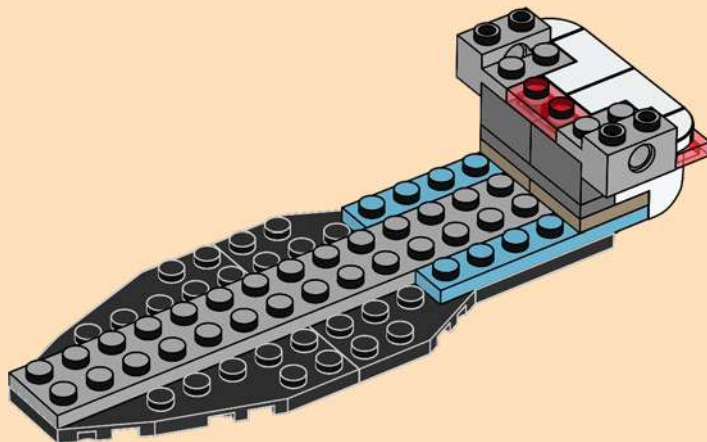

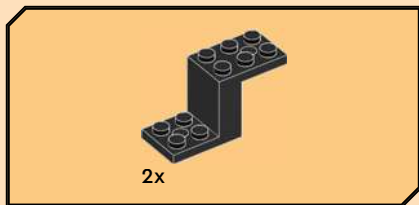

15

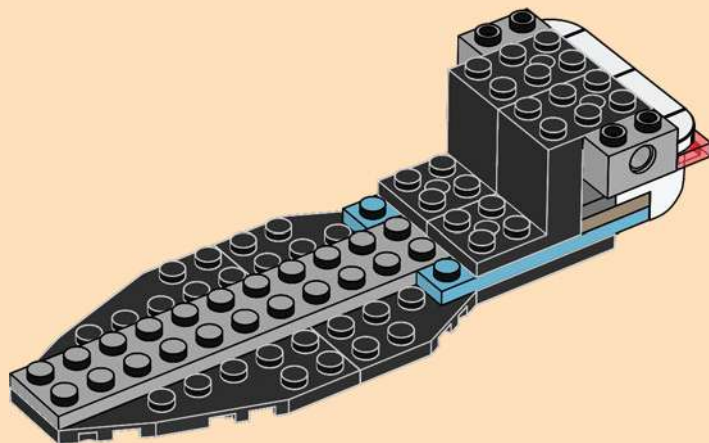

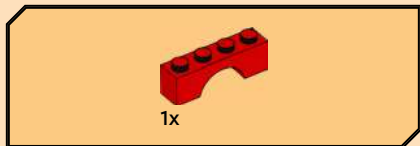

16

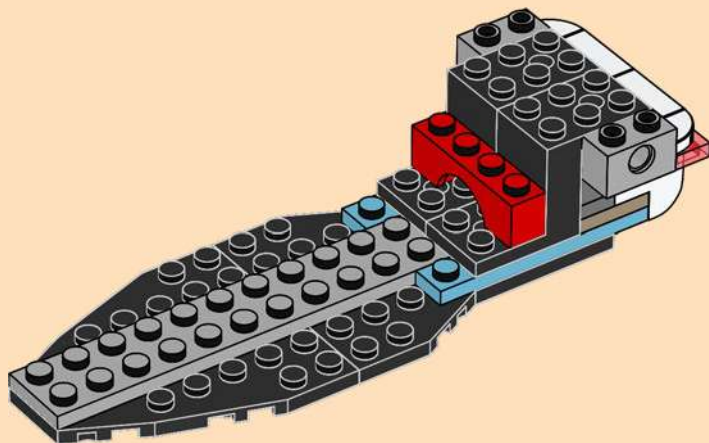

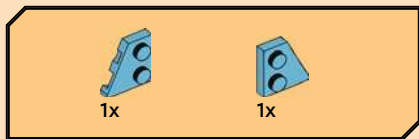

17

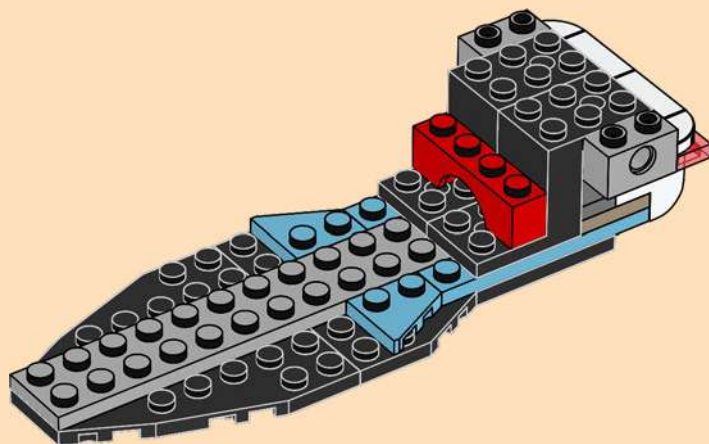



18

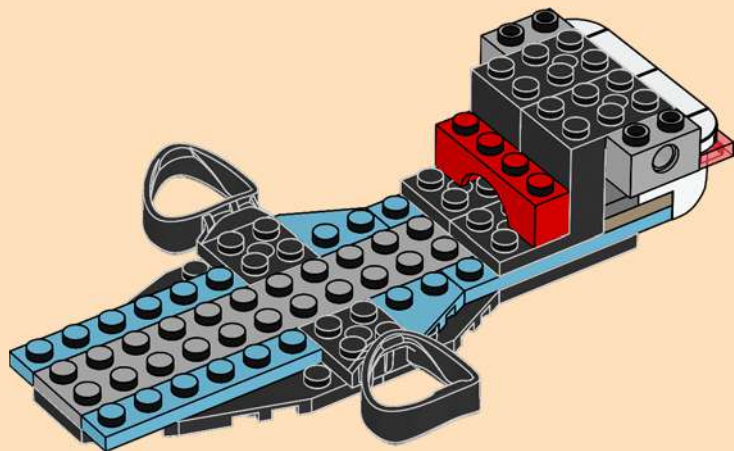

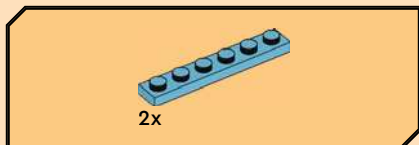

19

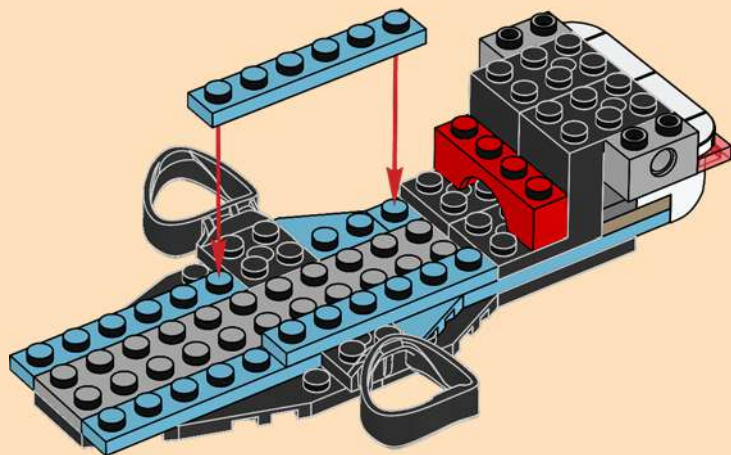

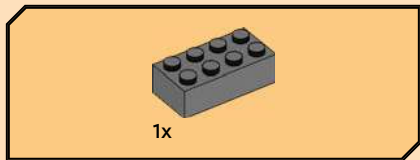

20

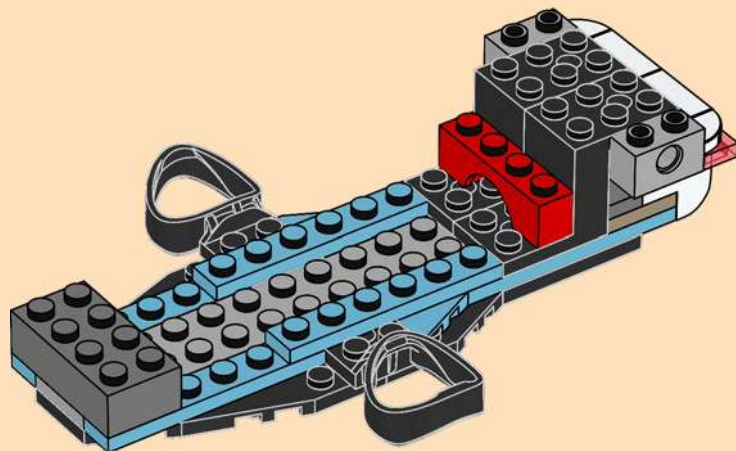



21

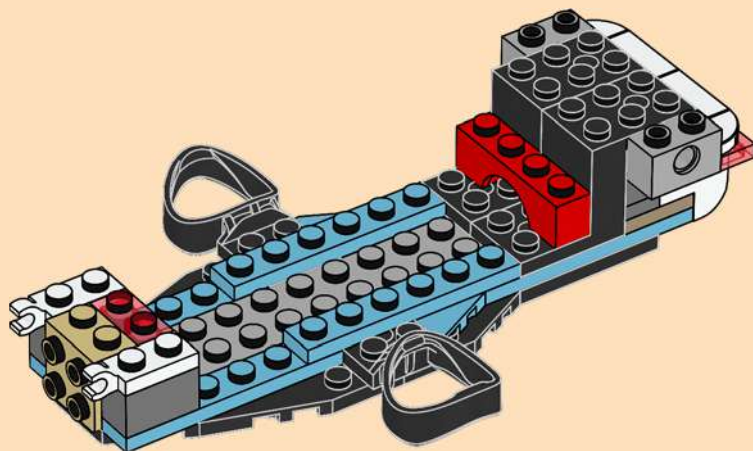



1x

22

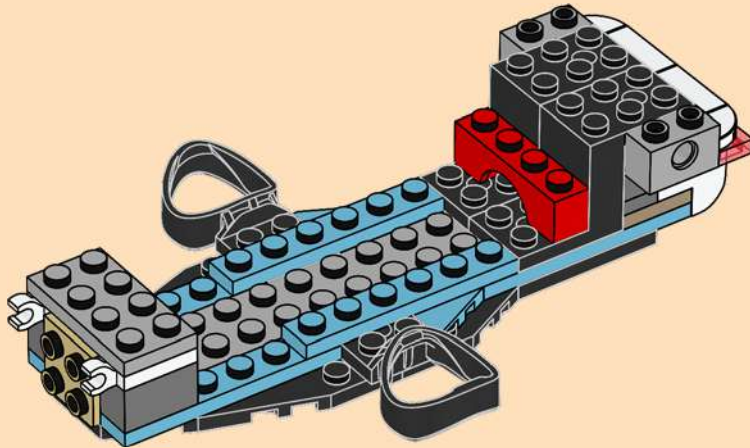



2x

23

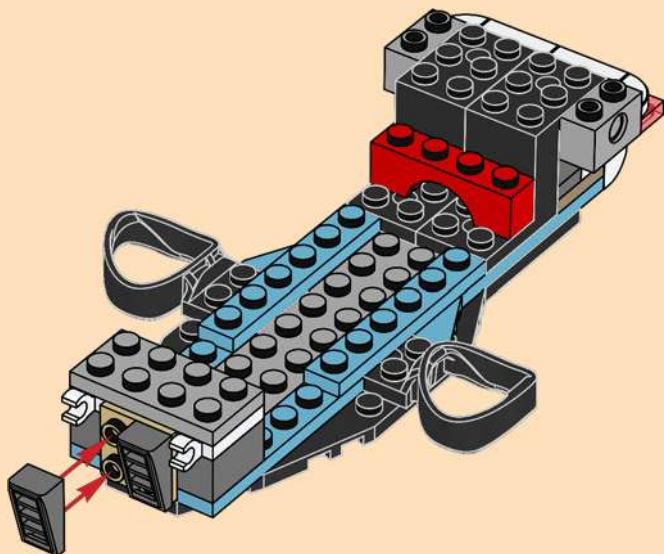

1x



1x

24

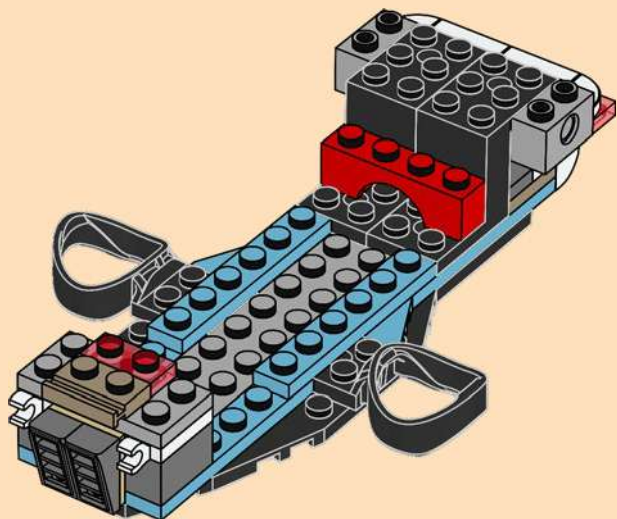



2x

25

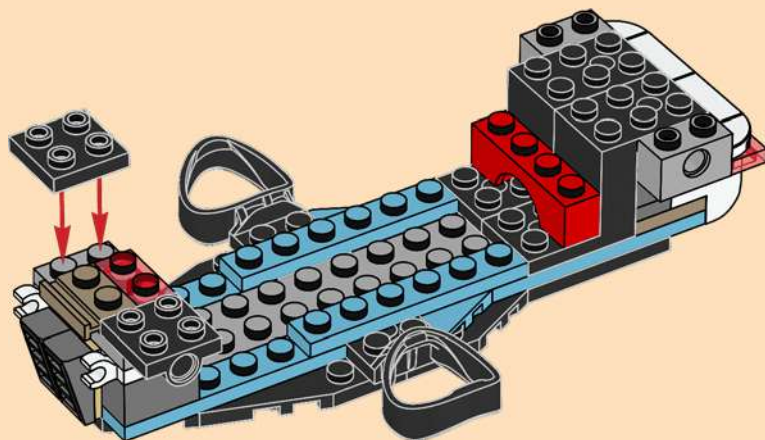

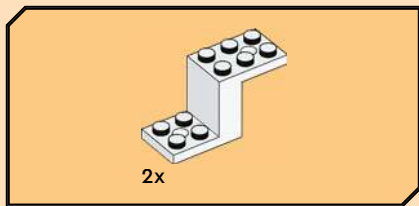

26

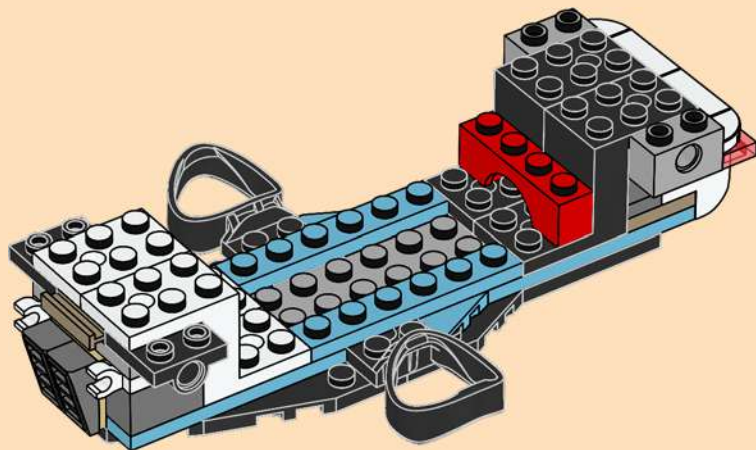

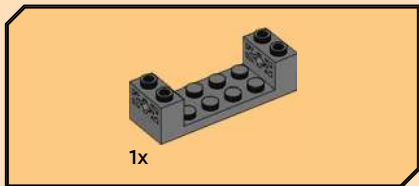
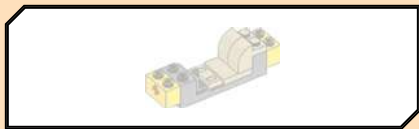

27

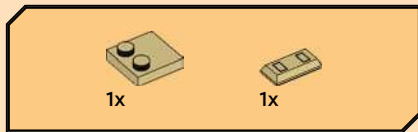
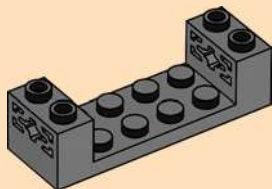

28

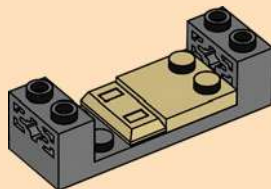



29

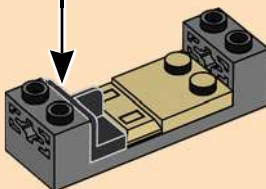

30

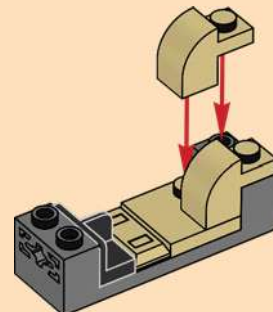

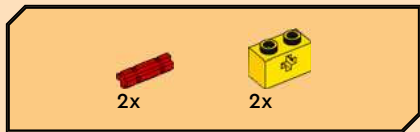

31

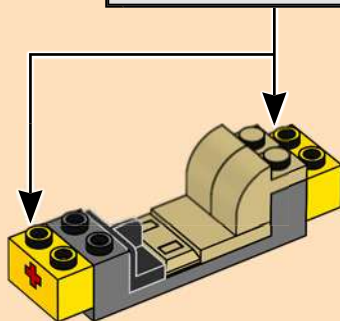
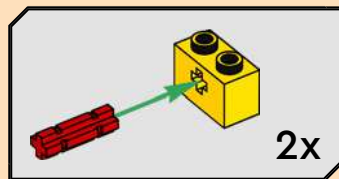

32

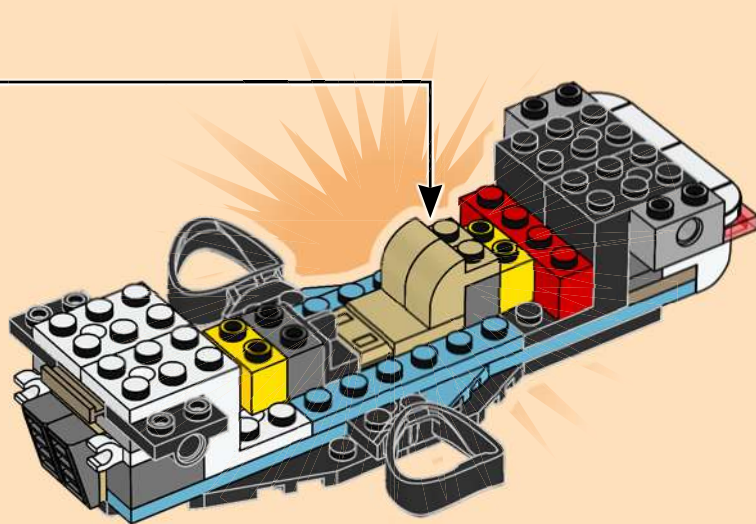

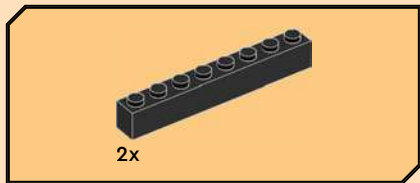

33

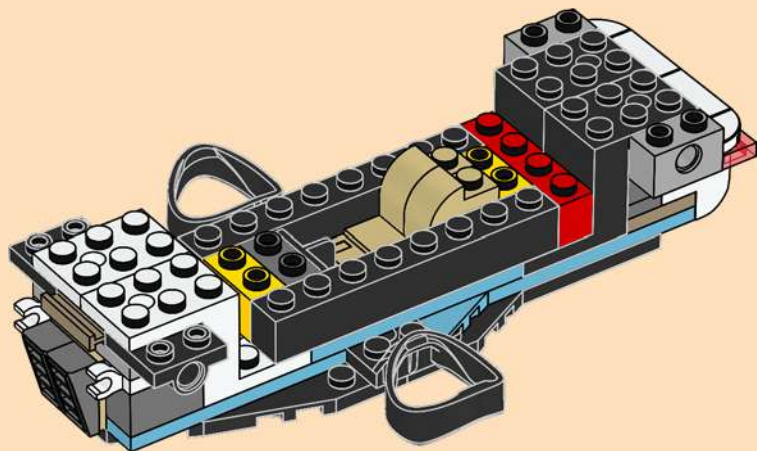

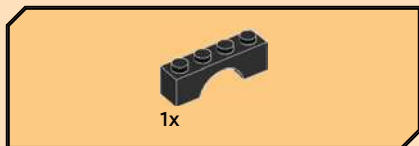

34

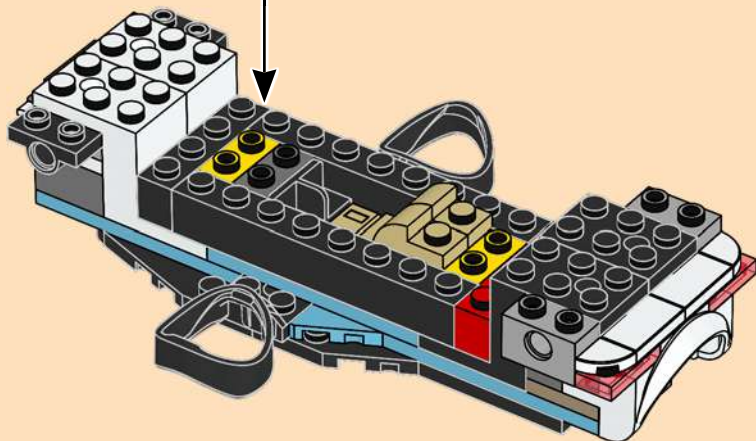
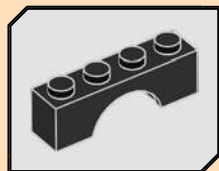

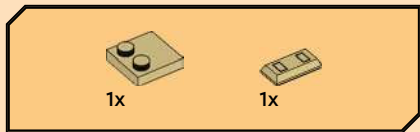

35

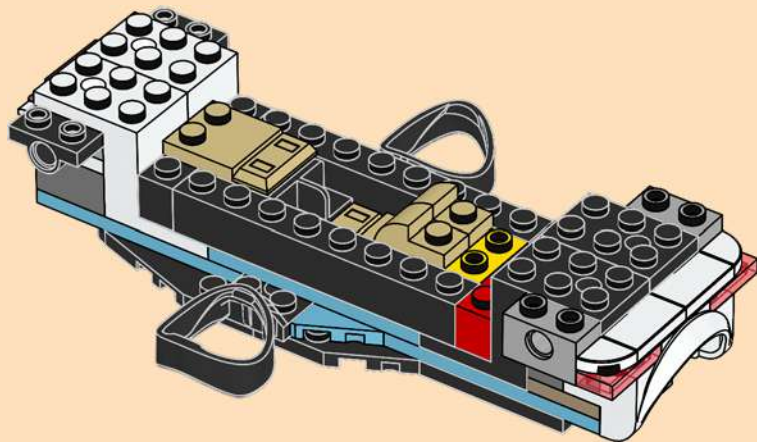

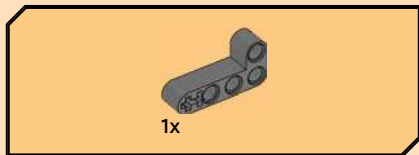
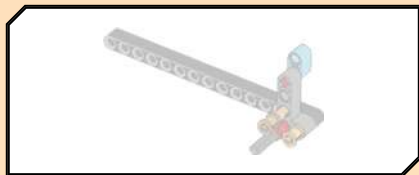

36

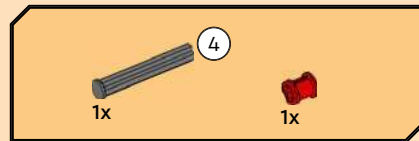
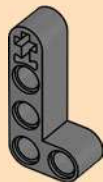

37

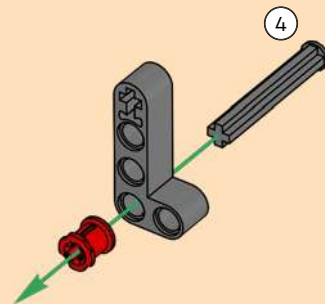



38

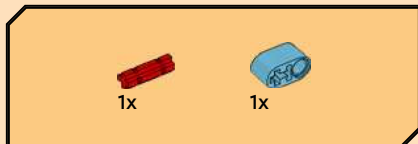
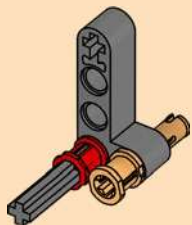

39

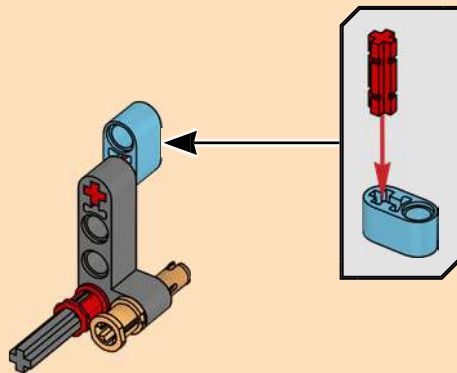

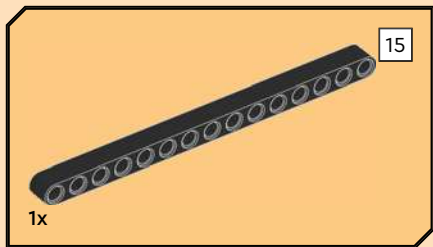

41

40

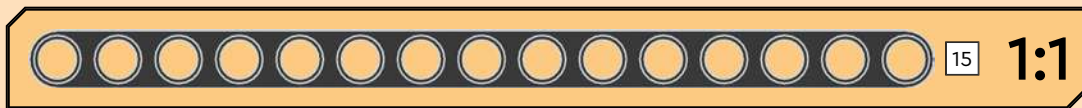
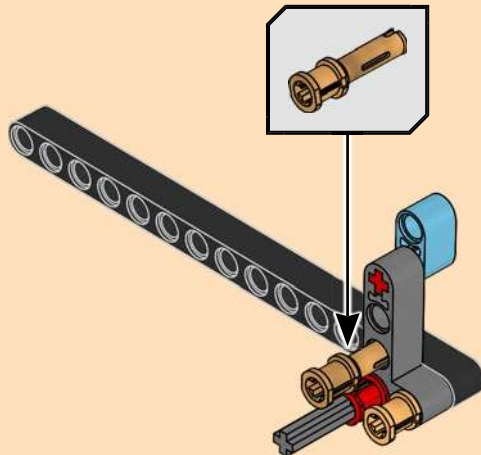
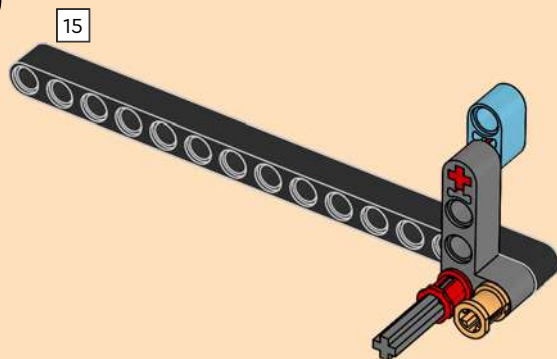

42

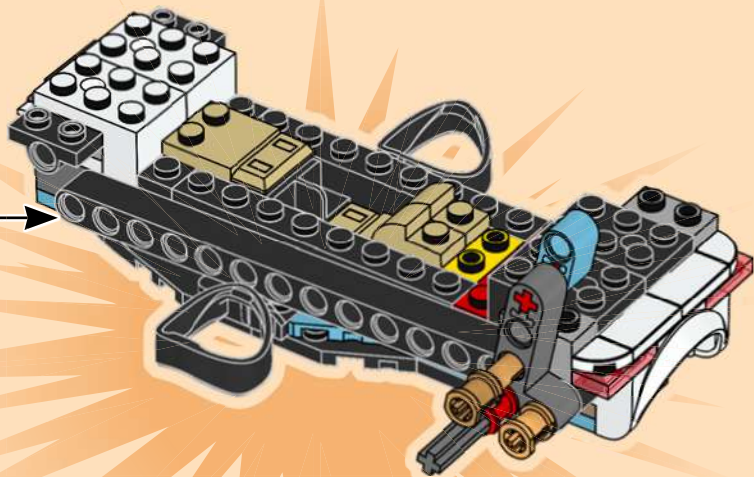

43

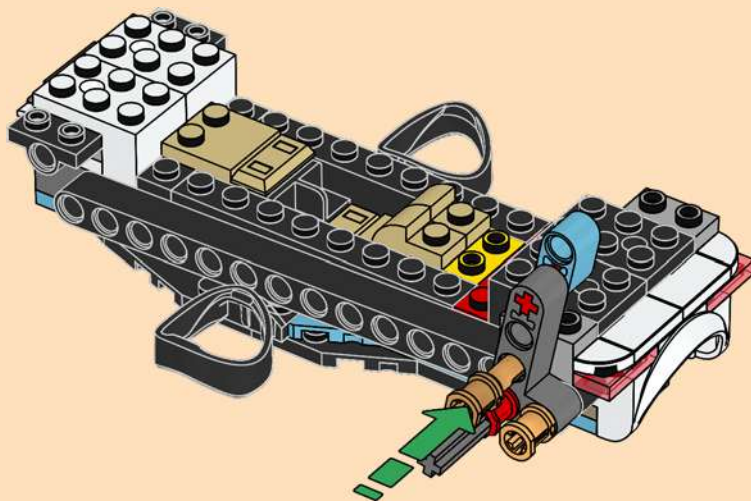

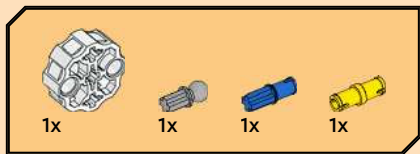

44

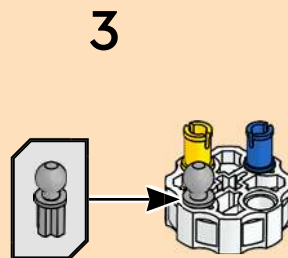
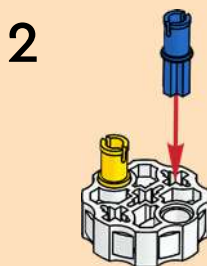
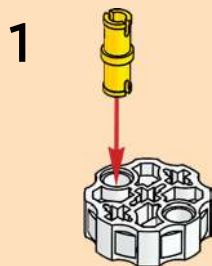

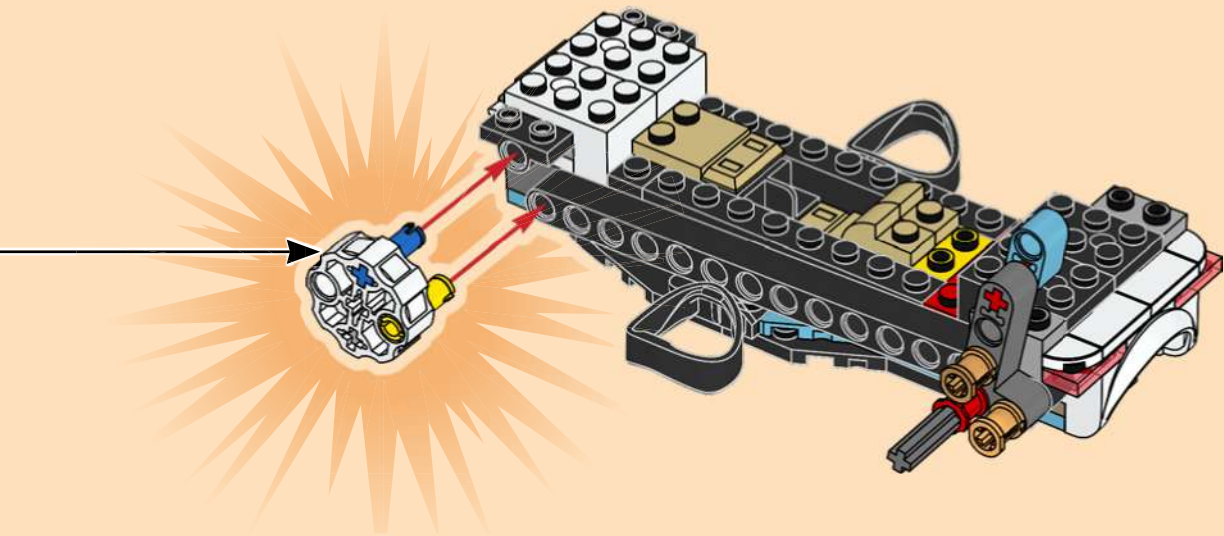

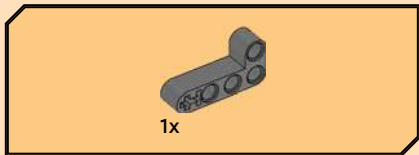
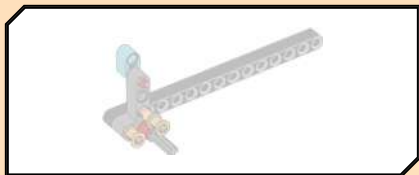

45

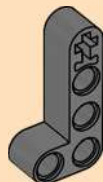

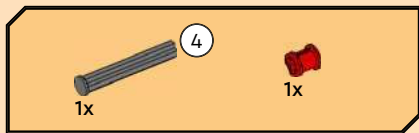

46

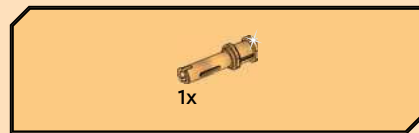
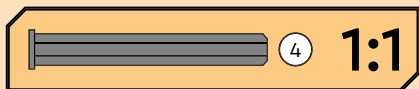
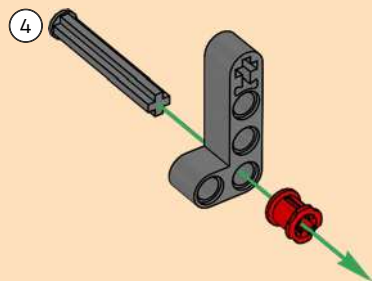

47

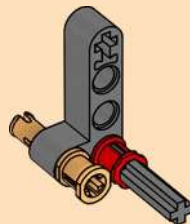

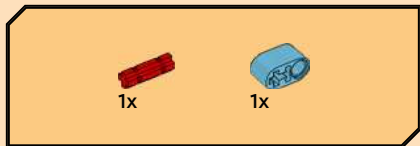

48

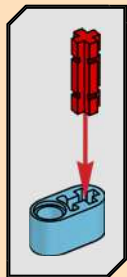

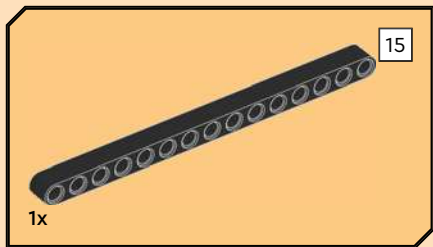

49

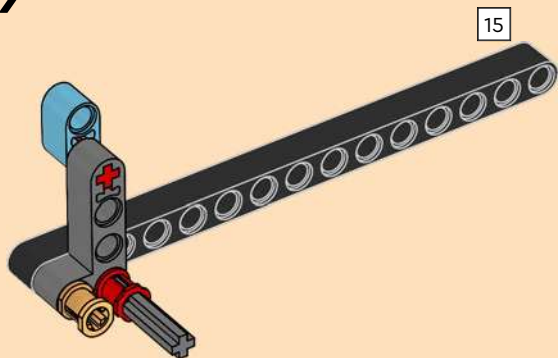

50

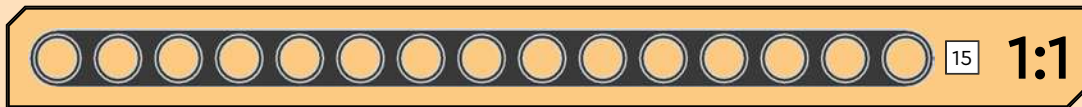
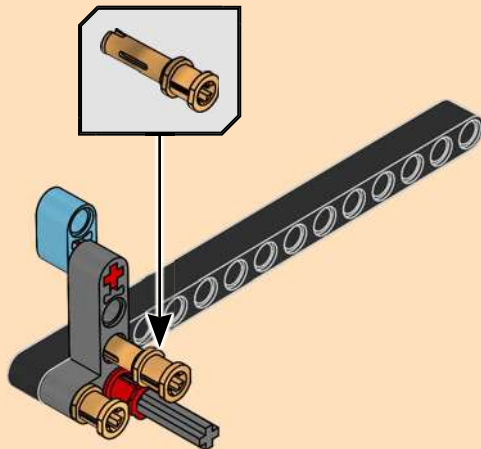

51

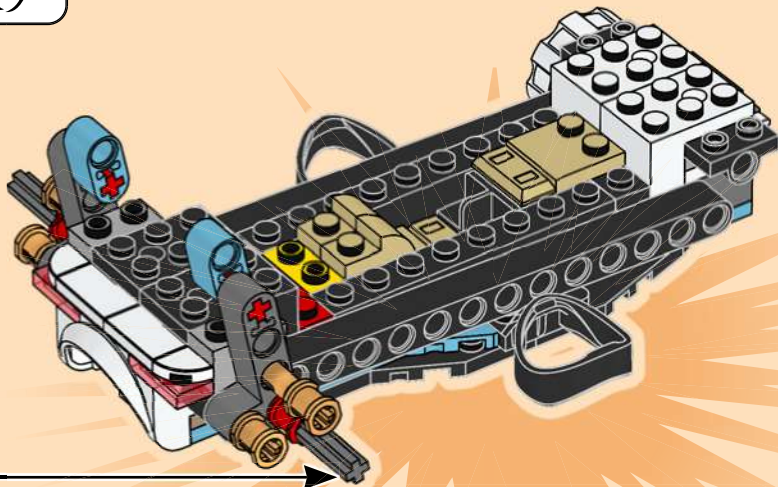

52

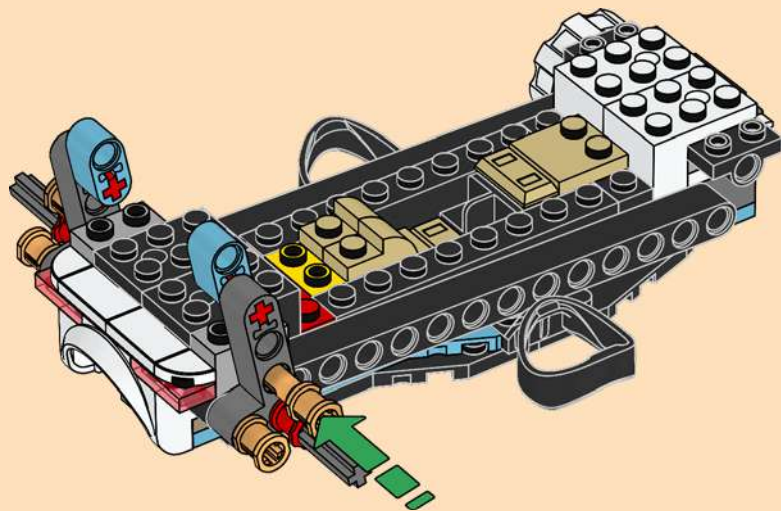

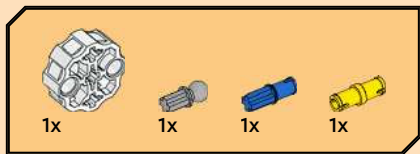

53

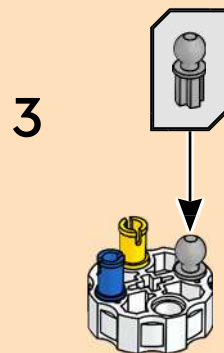
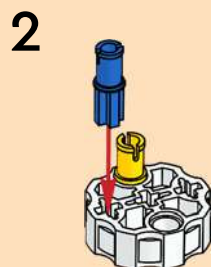
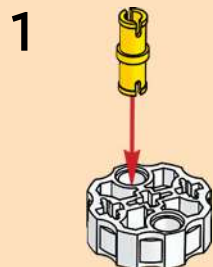

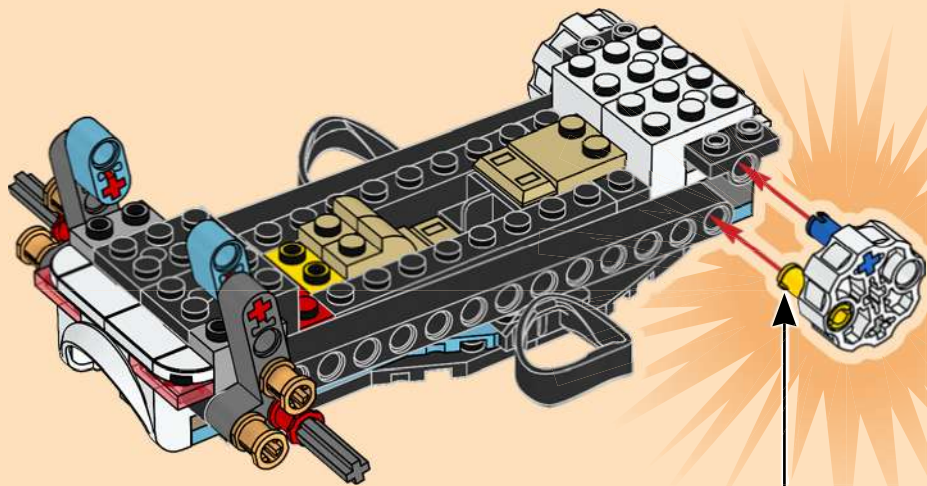



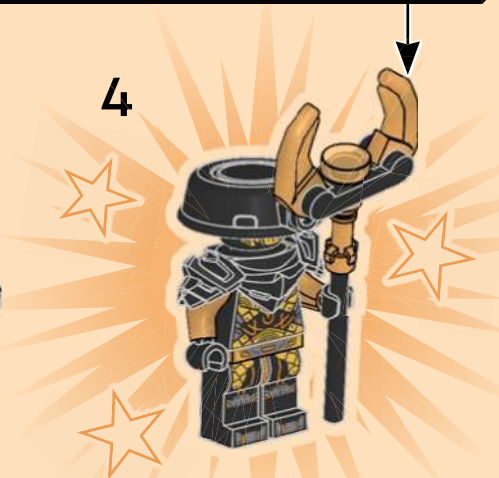
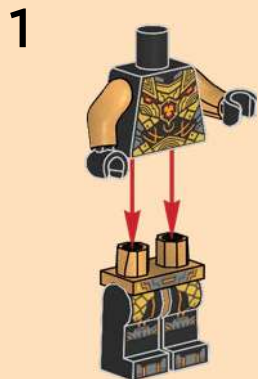
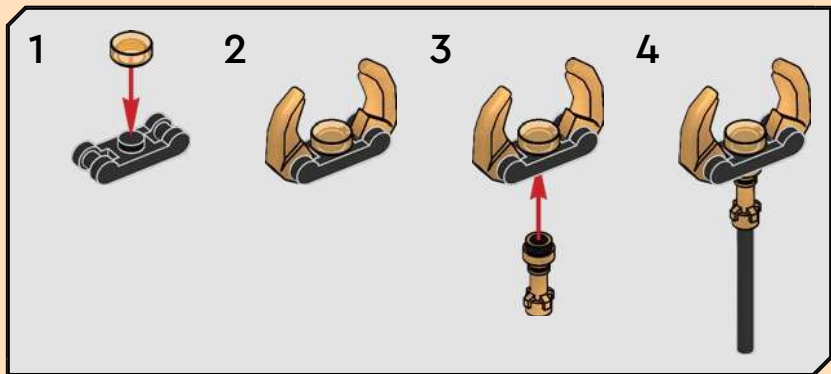



54

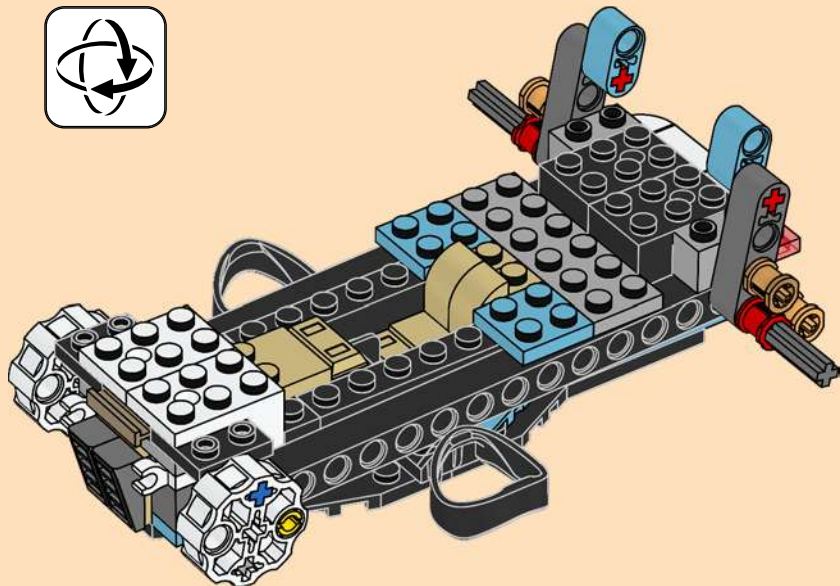
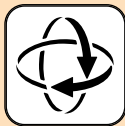



1x



2x

55

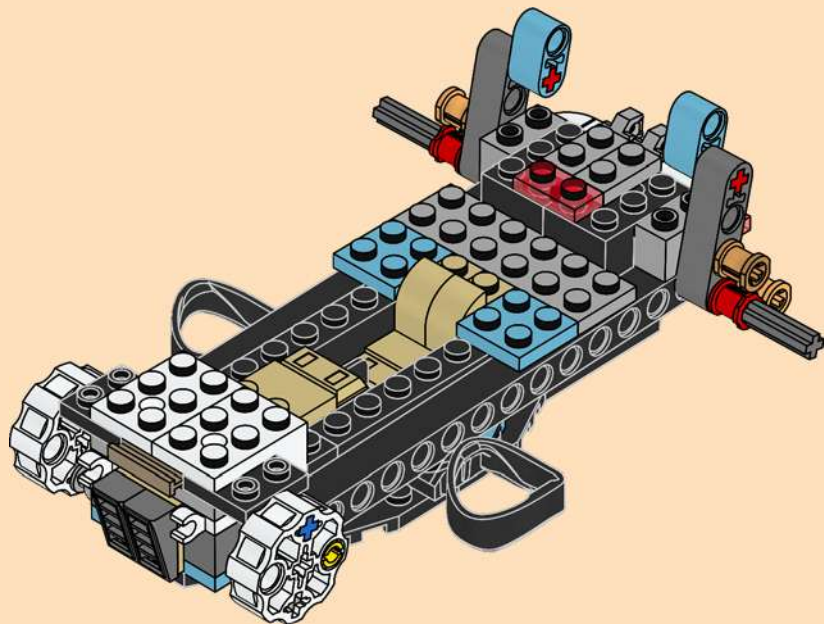

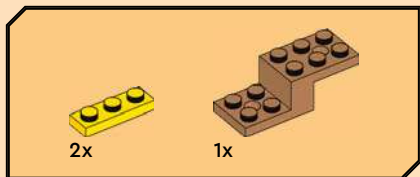

56

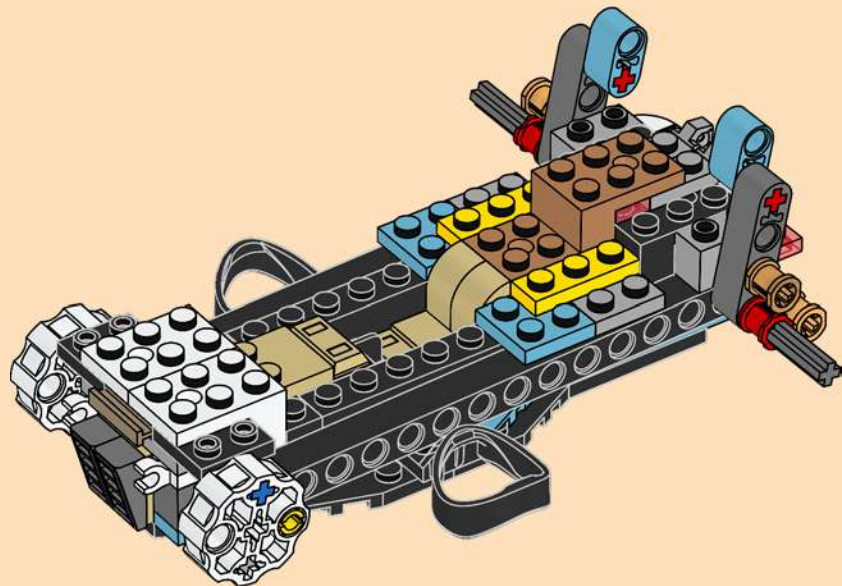



4x

57

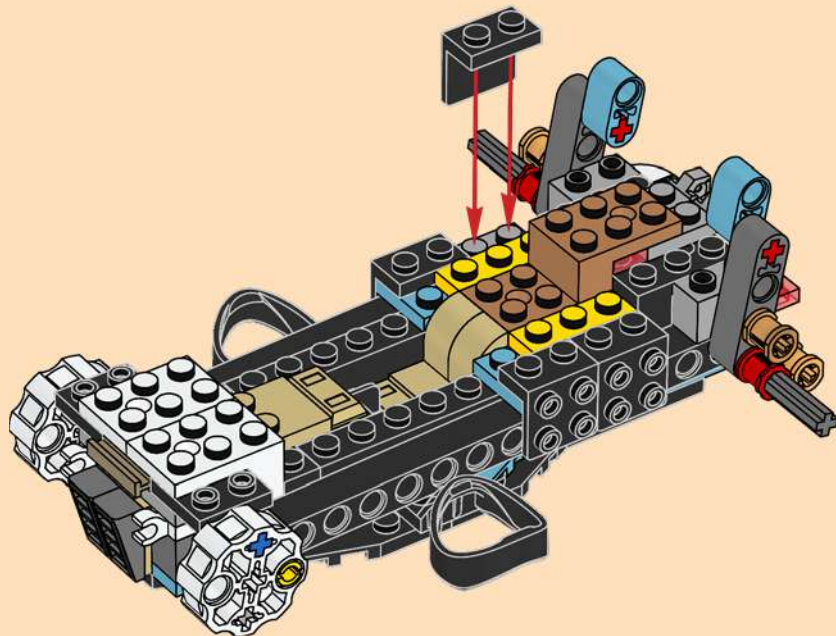

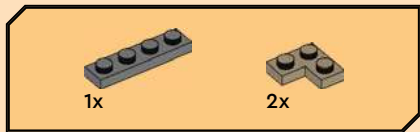

58

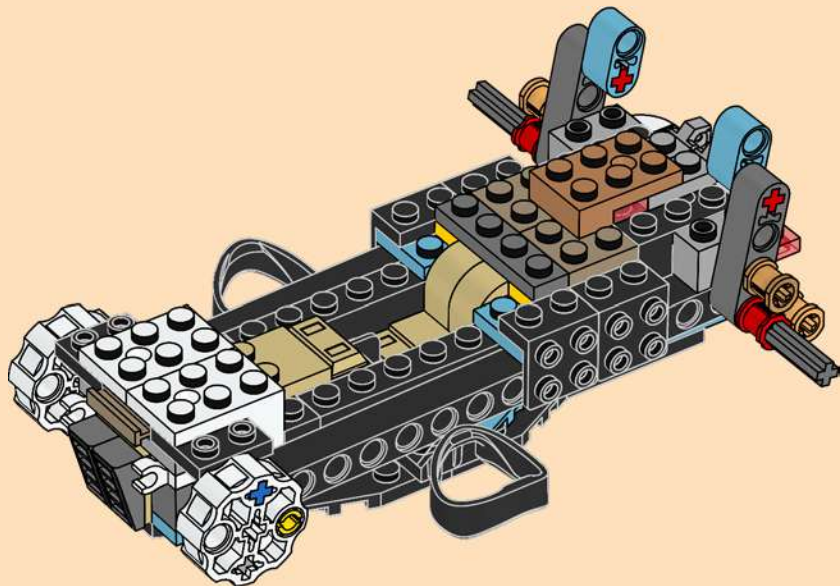



2x

59

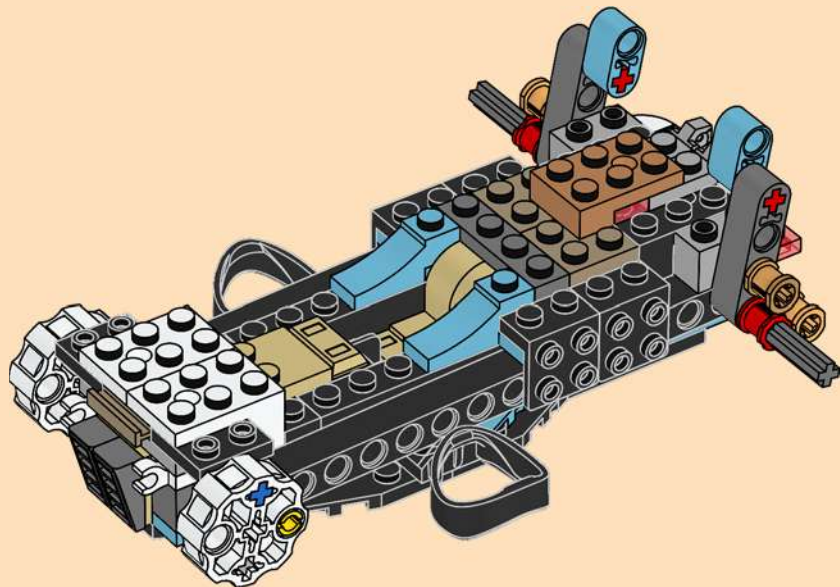

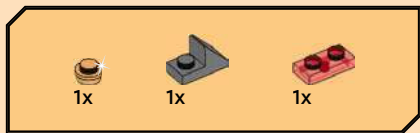

60

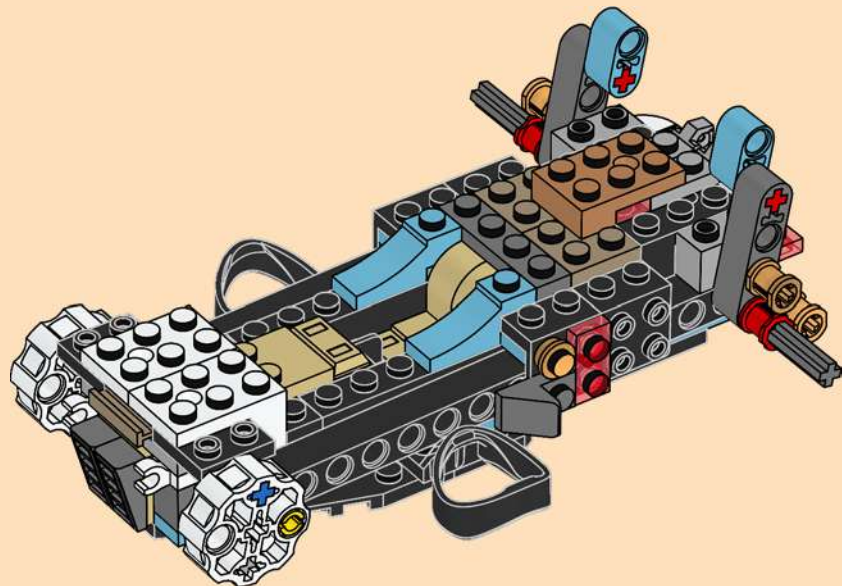



1x

61

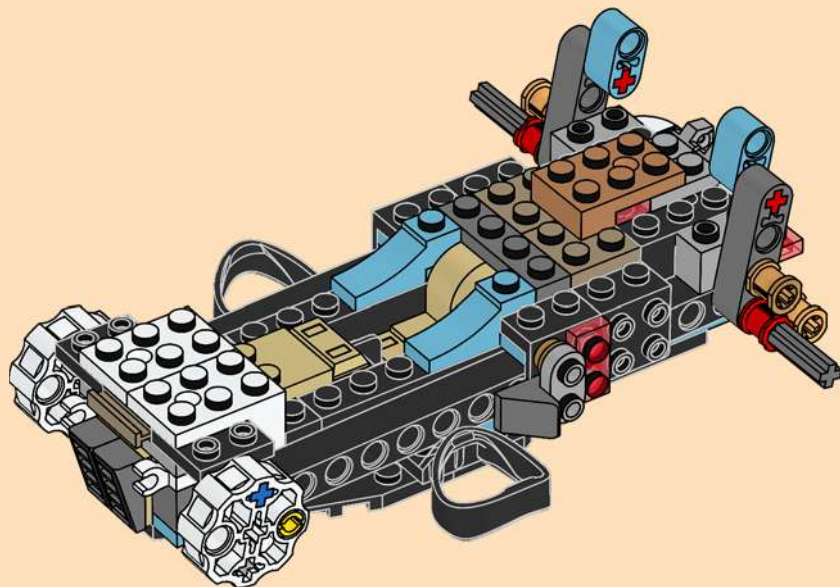

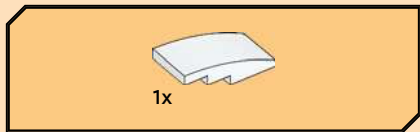

62

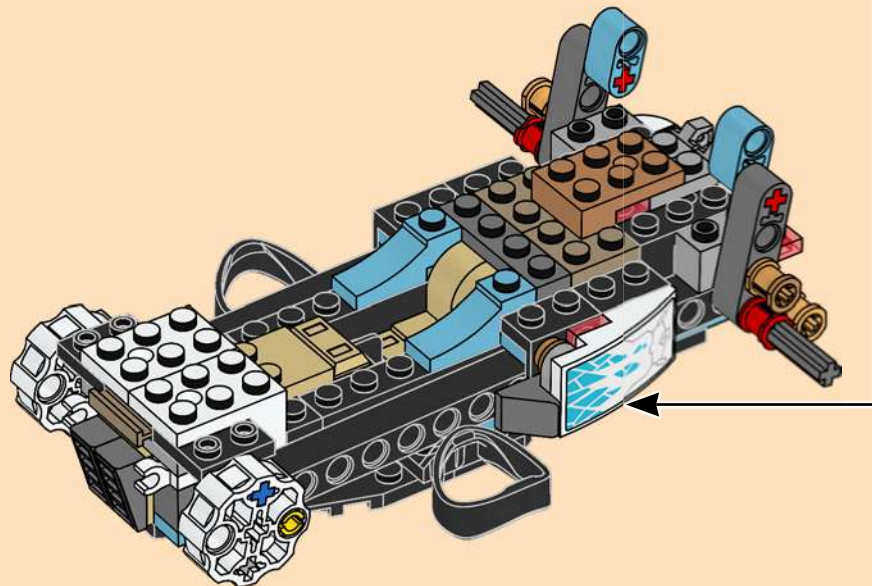
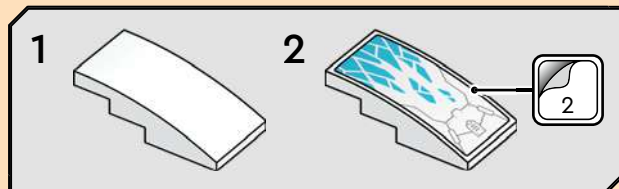

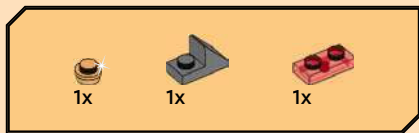

63

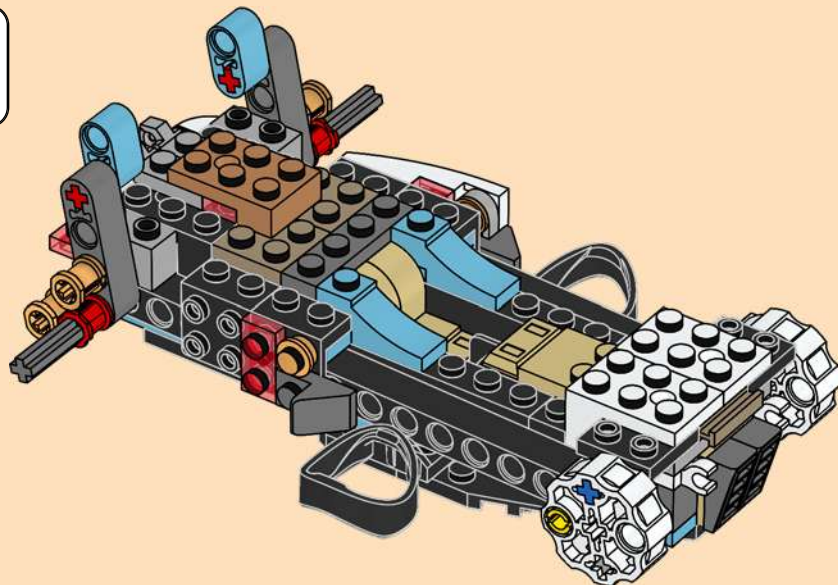



1x

64

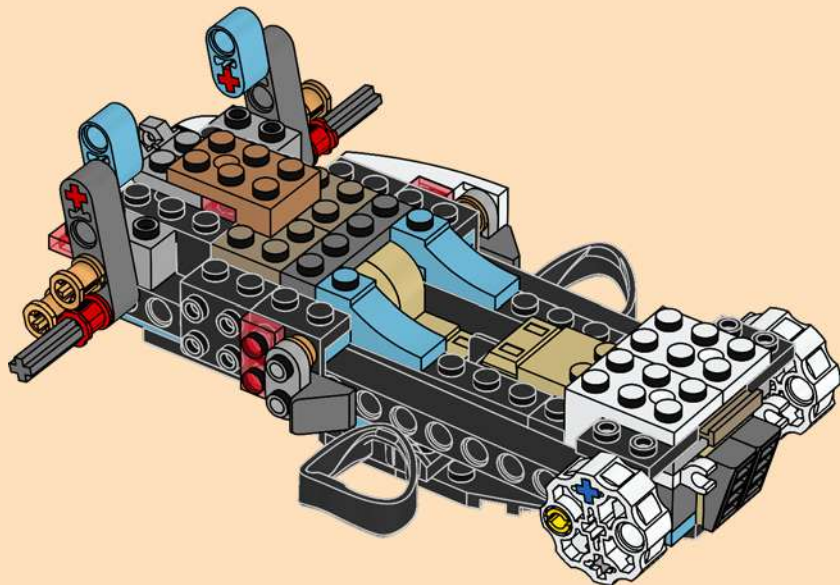

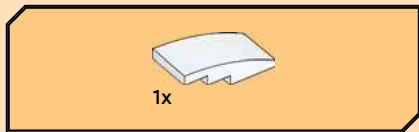

65

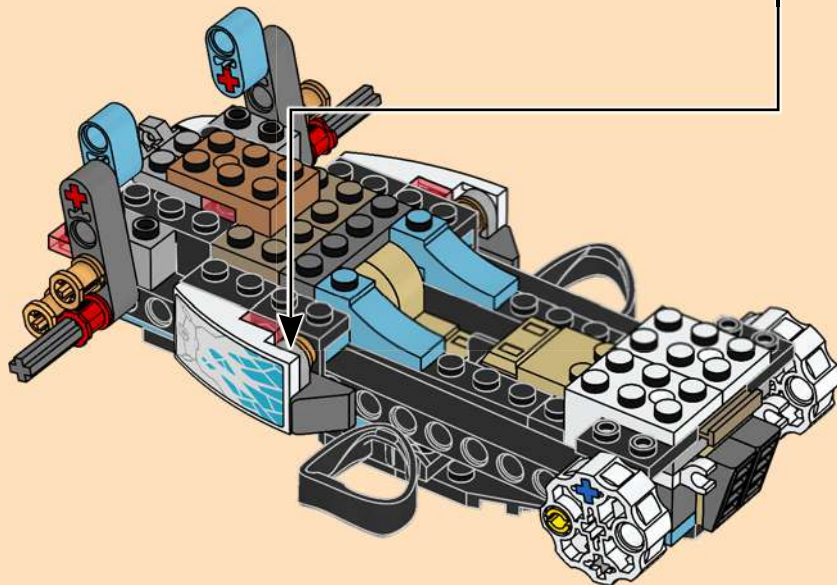
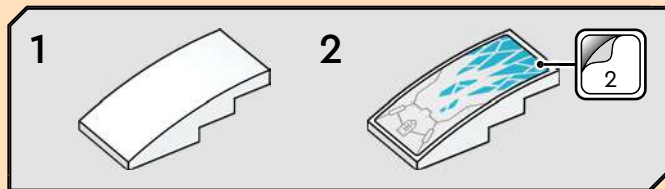



2x

67

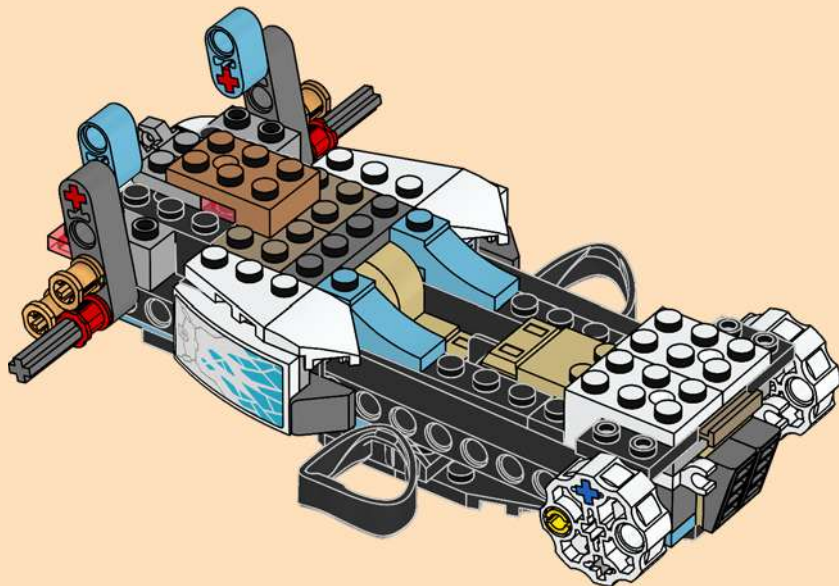

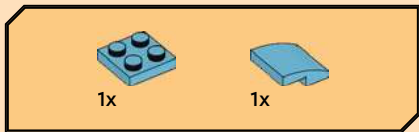

68

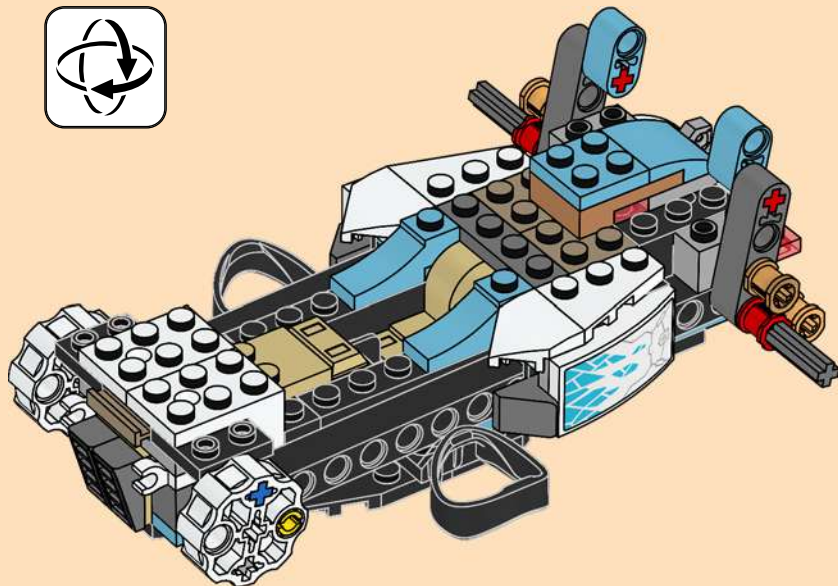
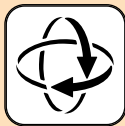

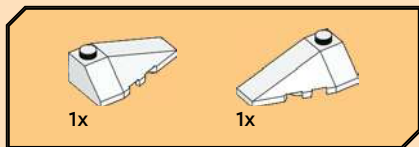

69

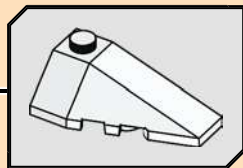
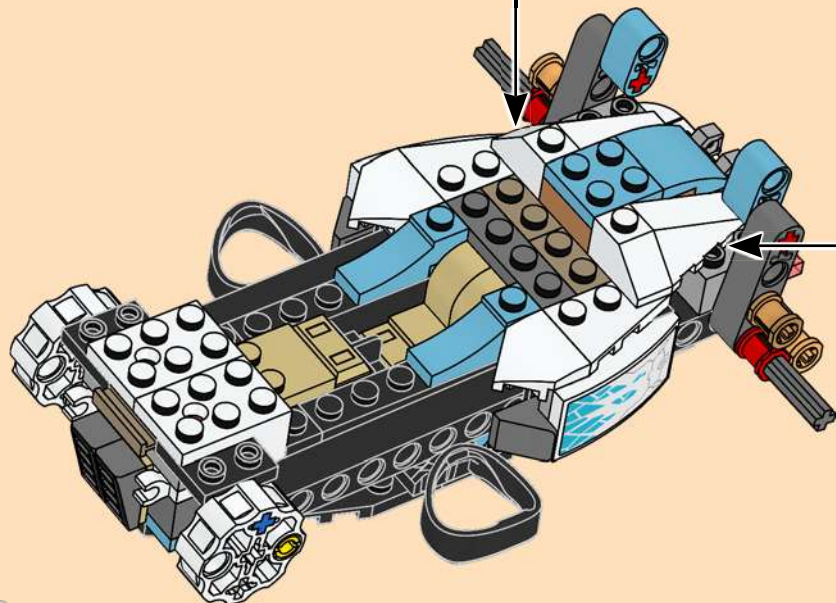
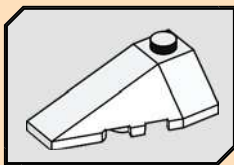



1x

70

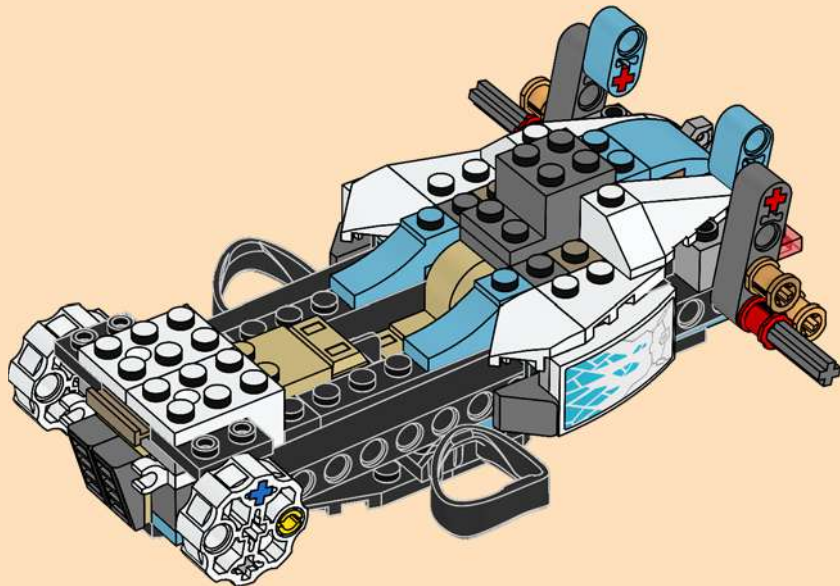

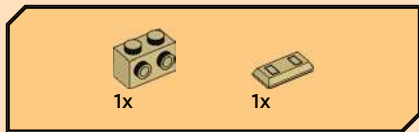

71

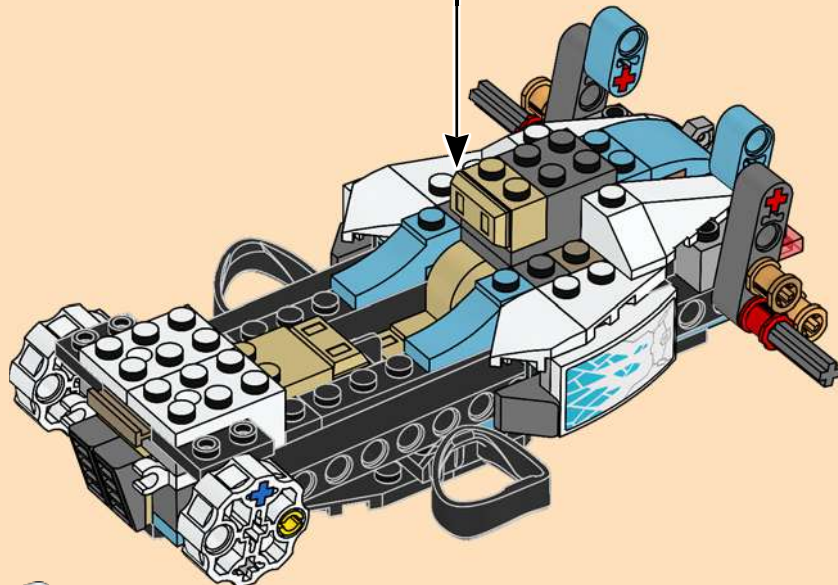
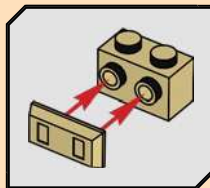



2x

72

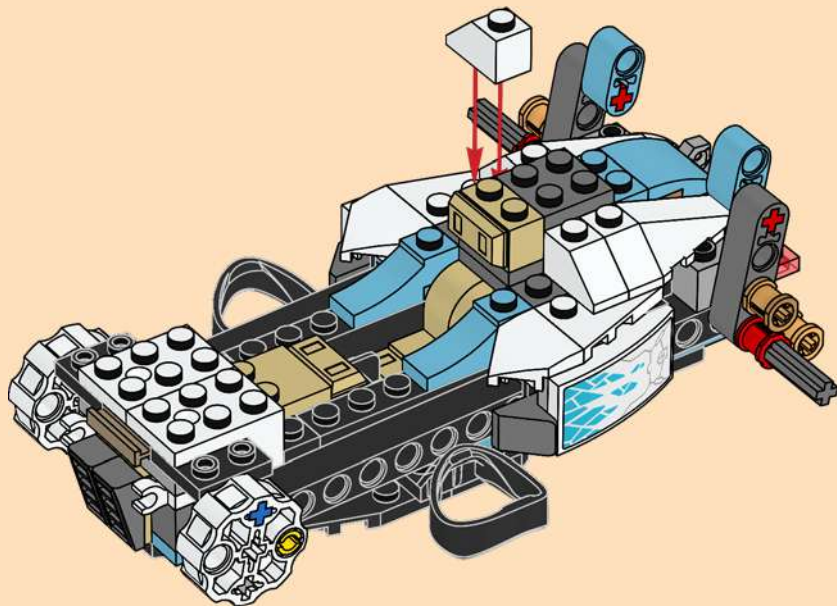



2x

73

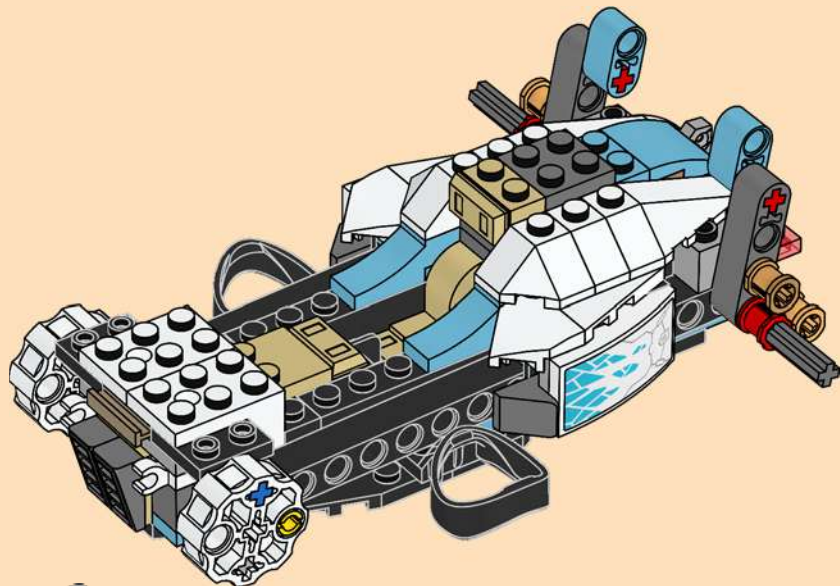



2x

74

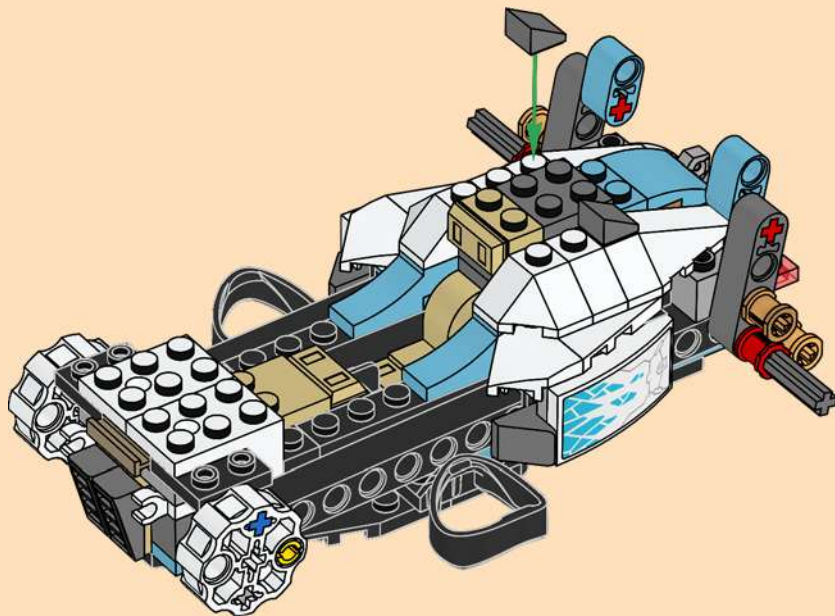



2x

75

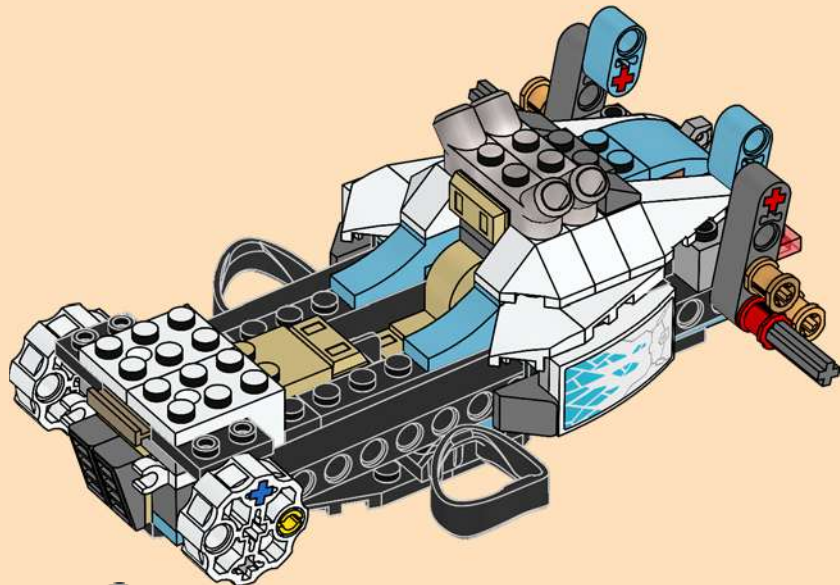



1x

76

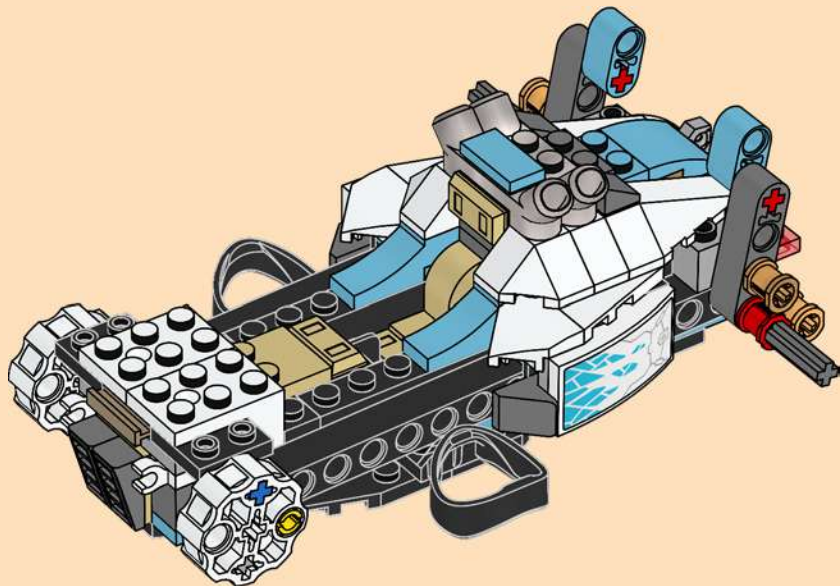

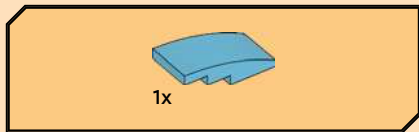

77

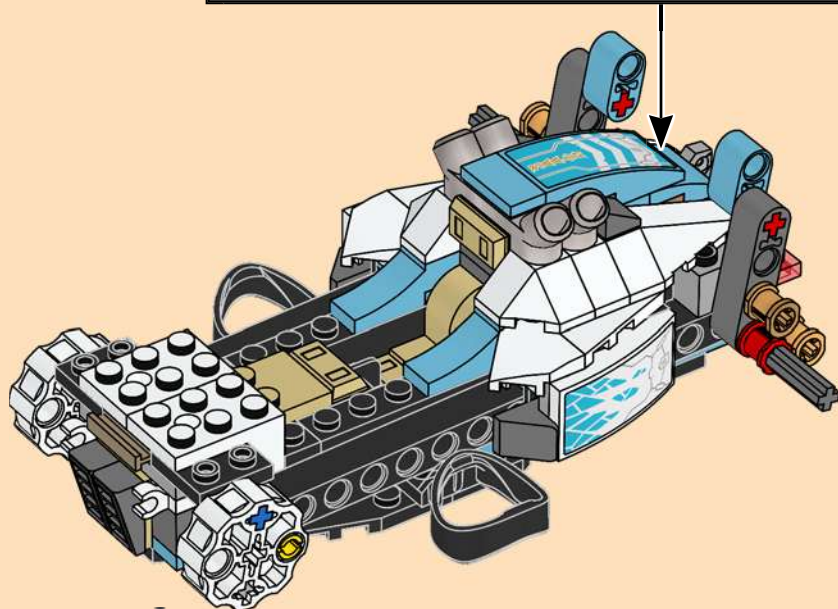
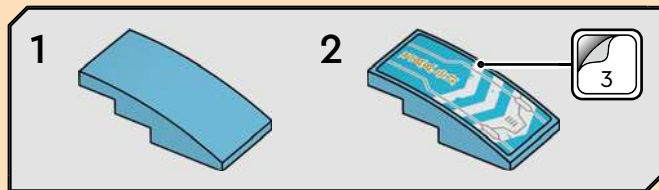

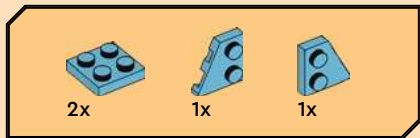

78

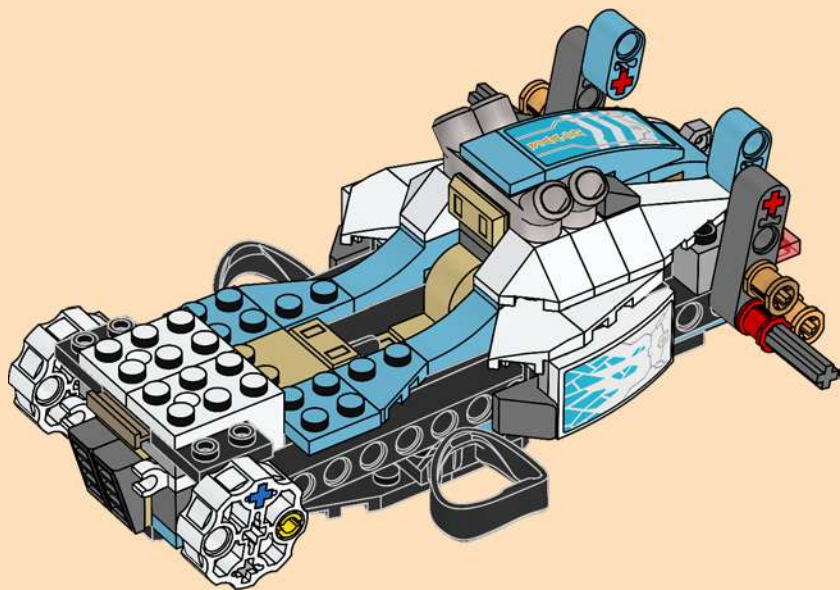

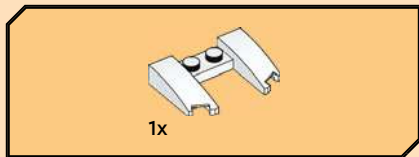

79

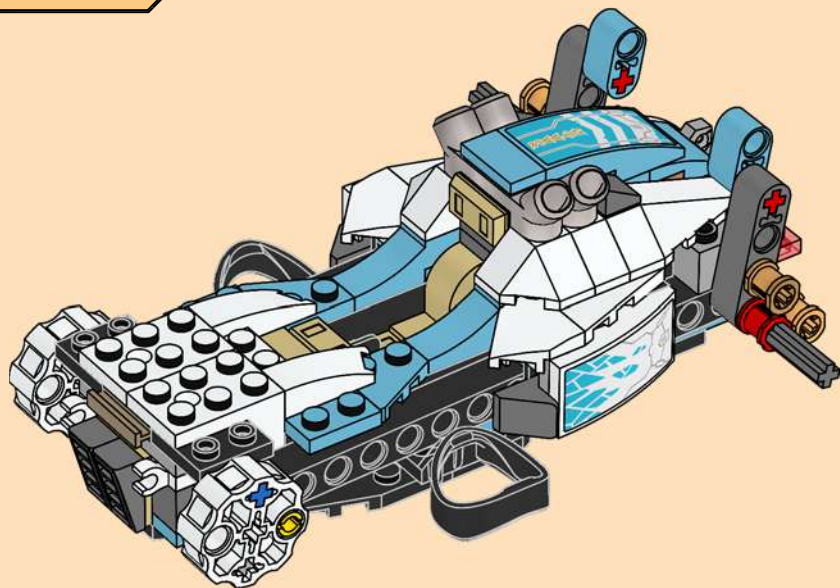



1x

80

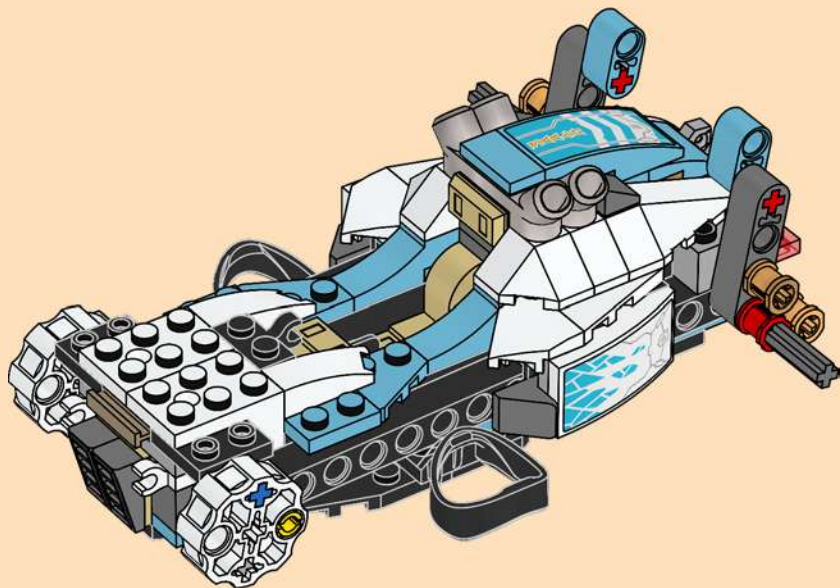



2x

81

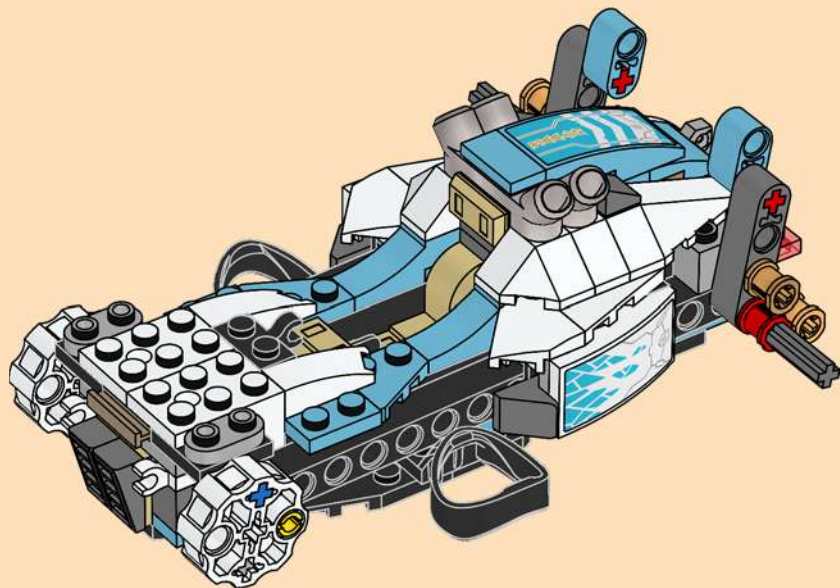

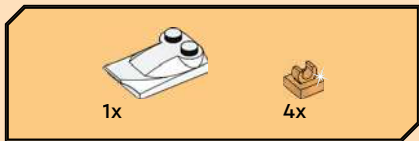

82

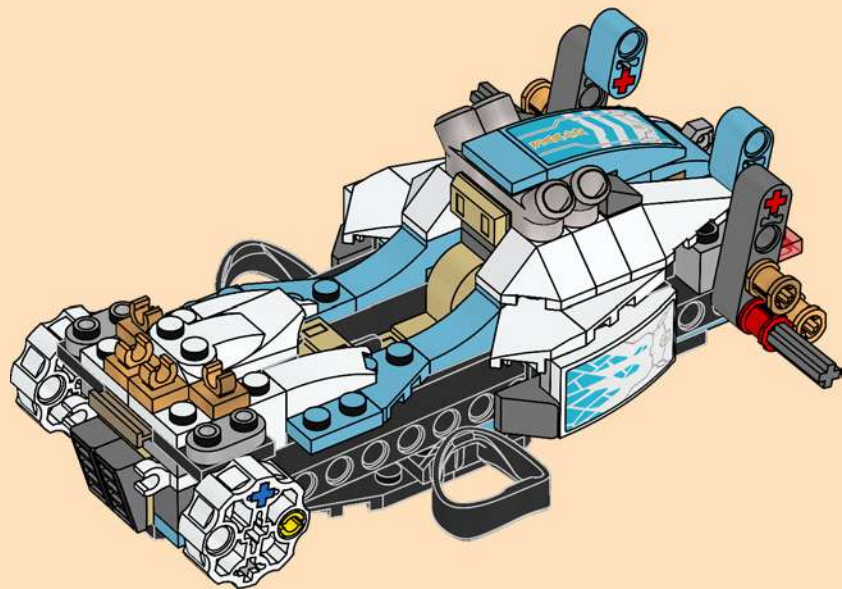



83

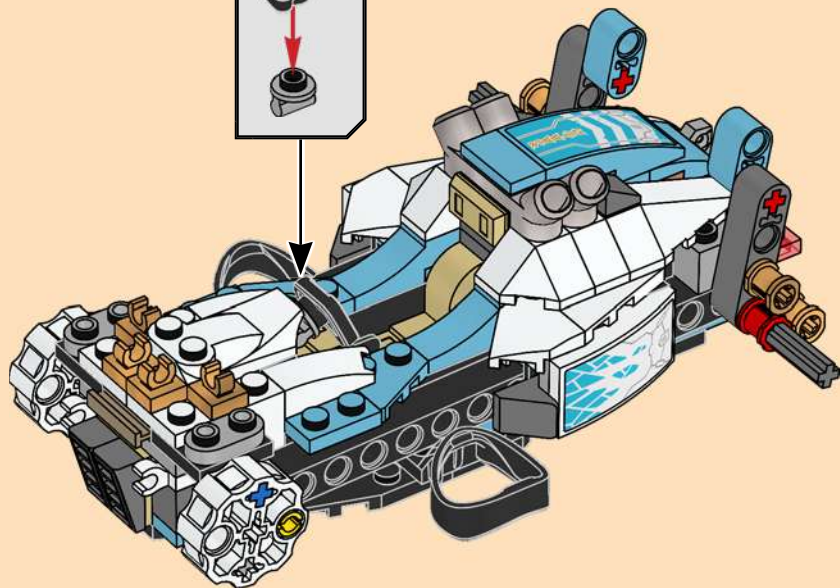

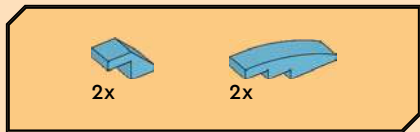

84

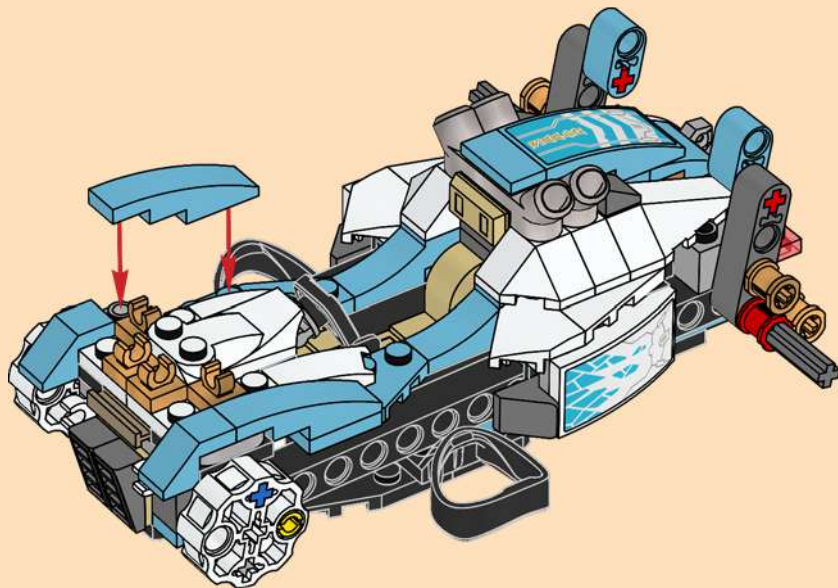



85

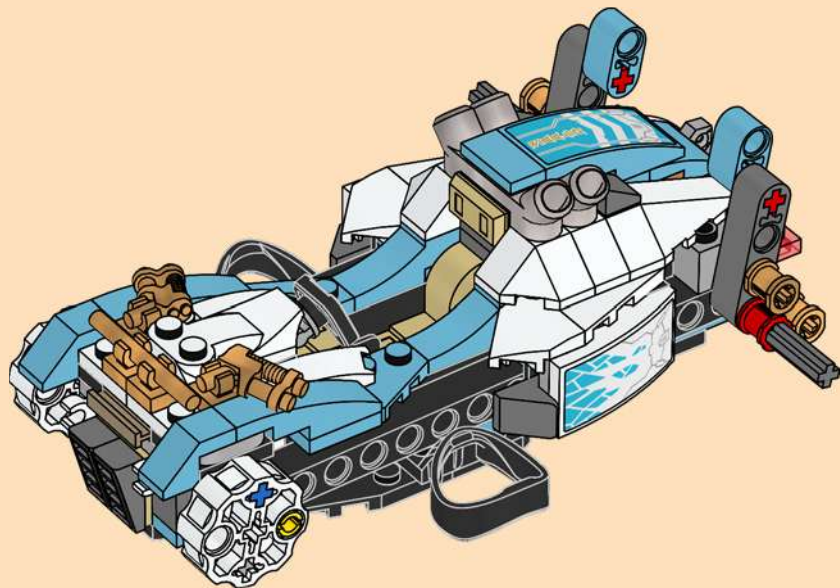



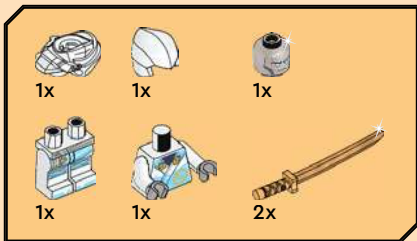

1

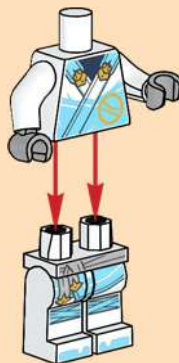

2

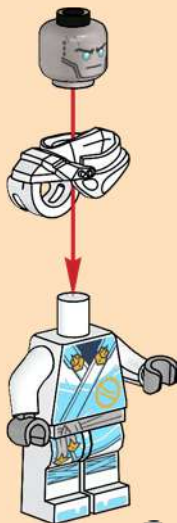

3



4





86





87

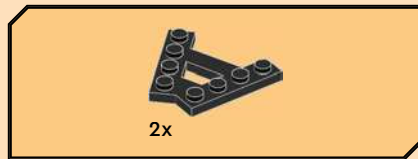
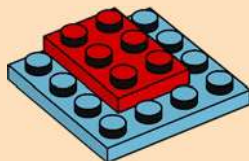

88

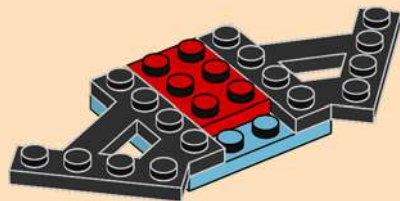

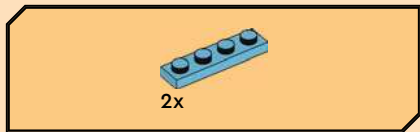

89



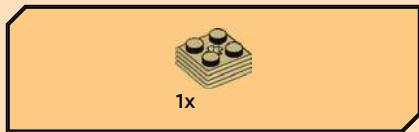

90

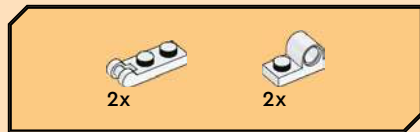
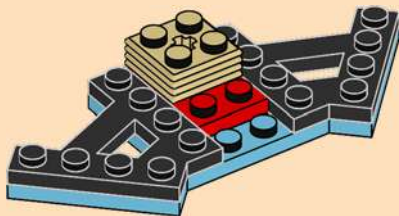

91

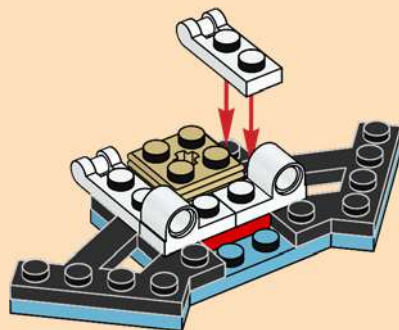



2x

92

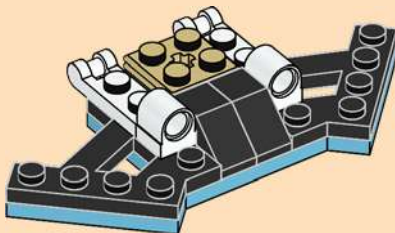



2x

93

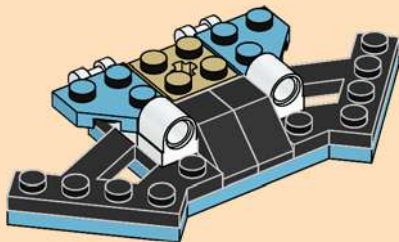

2x

94



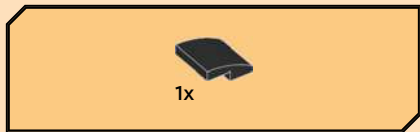

95

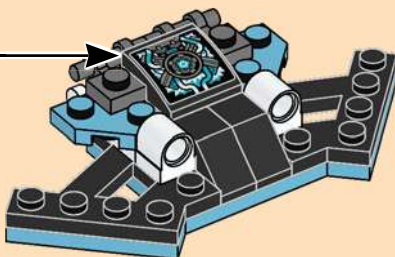
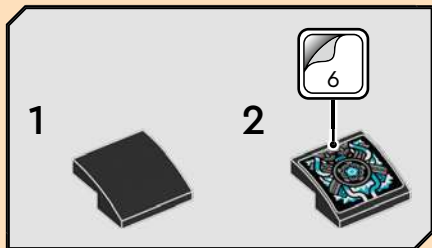



96

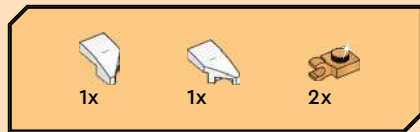
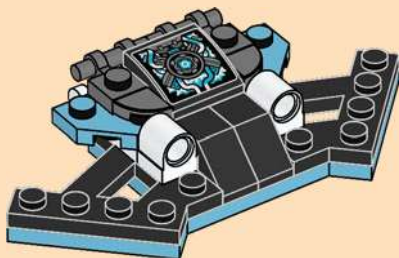

97

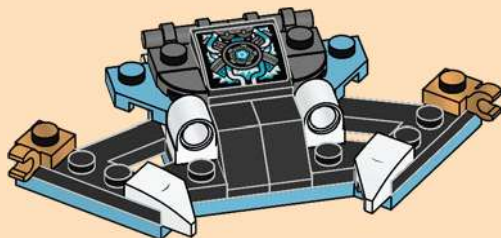



2x

98

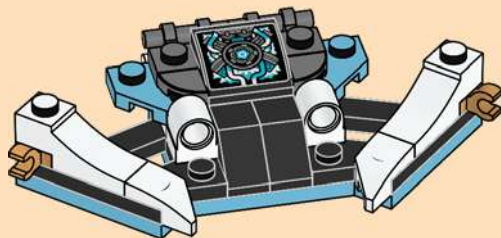



2x

99

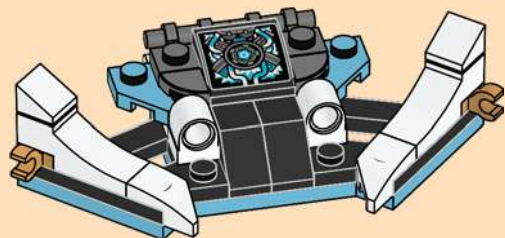

2x

100

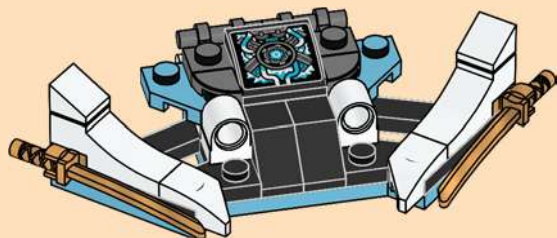

101

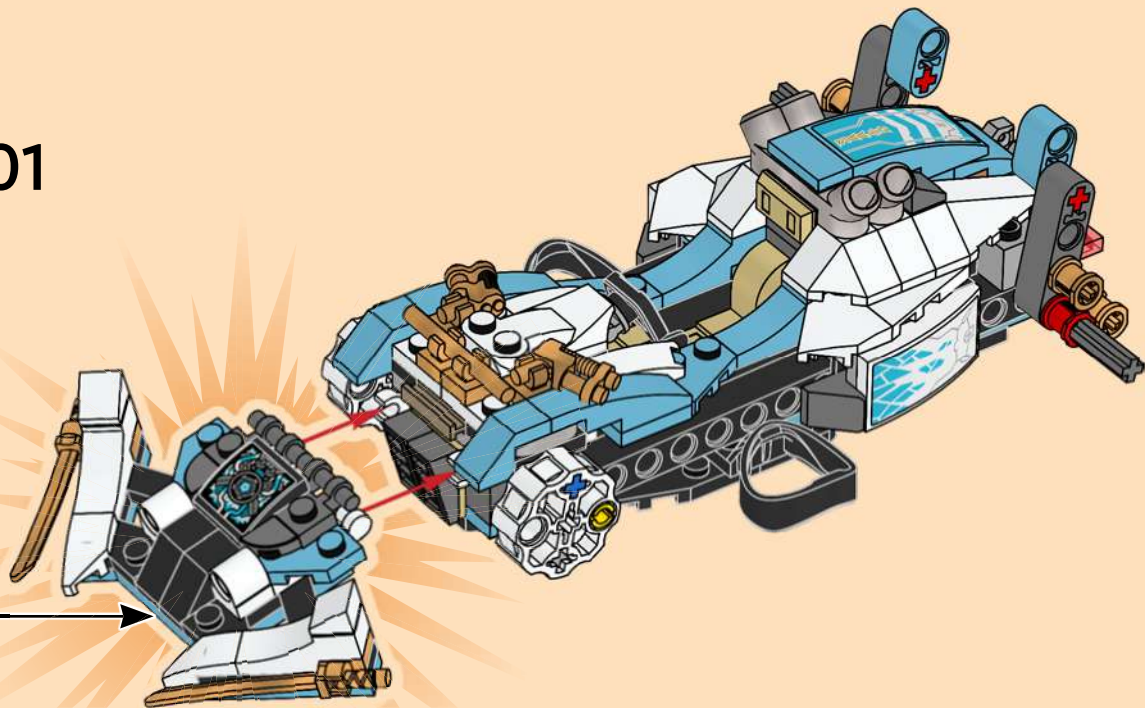

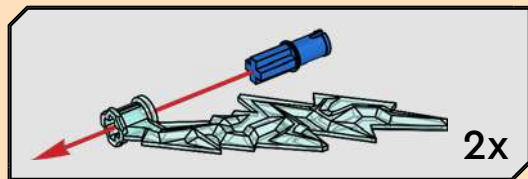
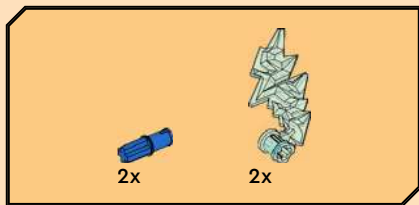

102

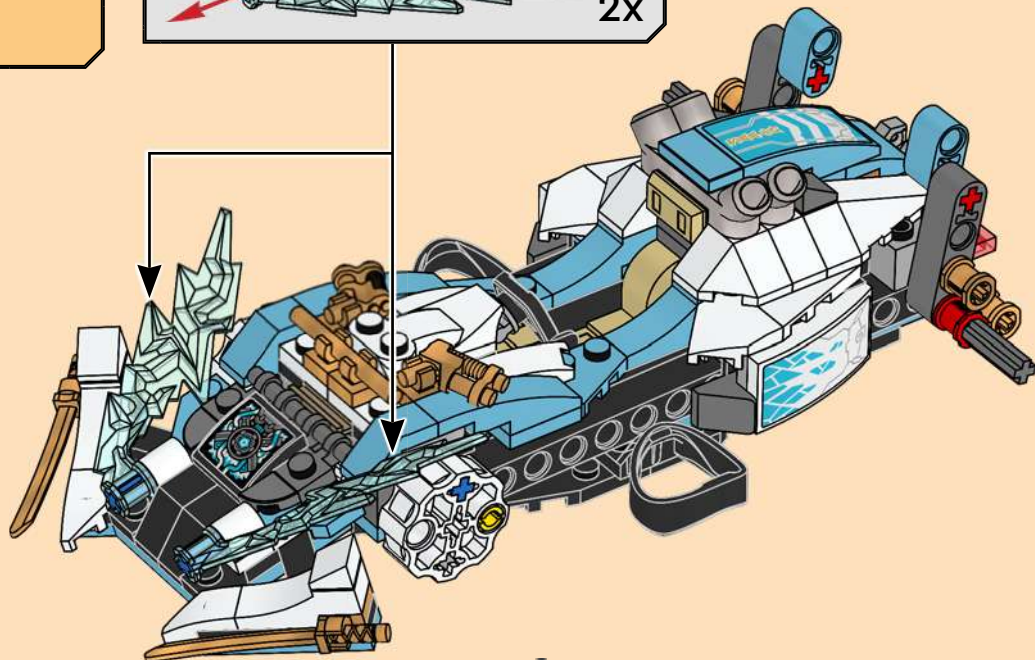

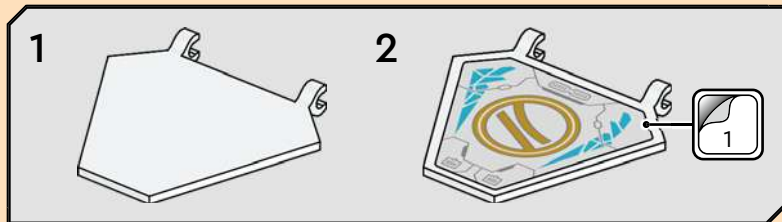
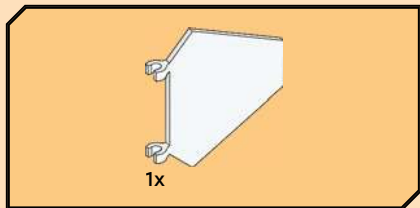

103

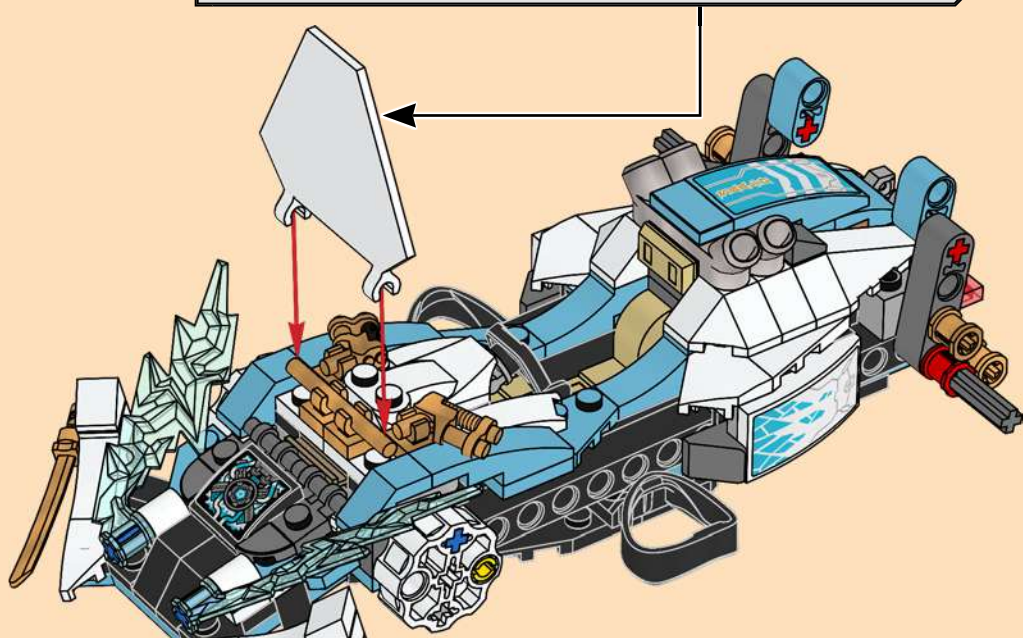

104

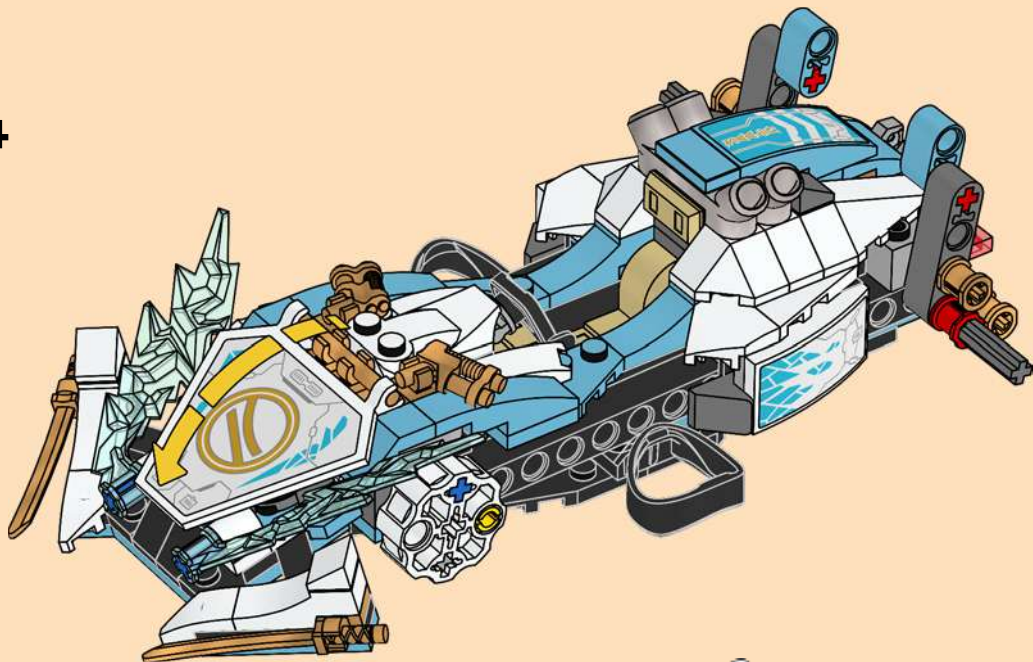



2x

105

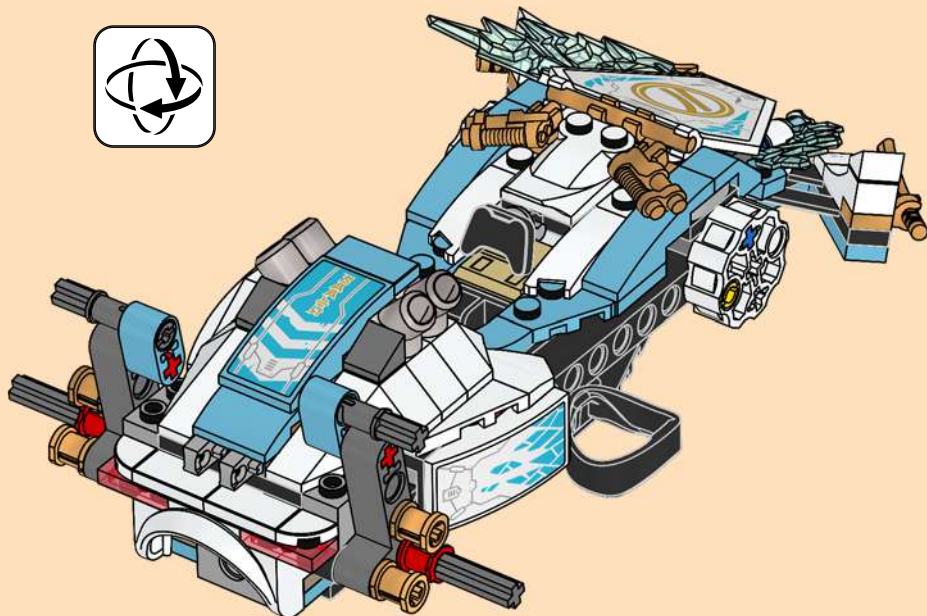
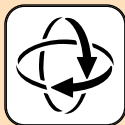

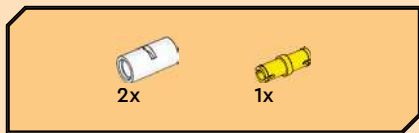

106

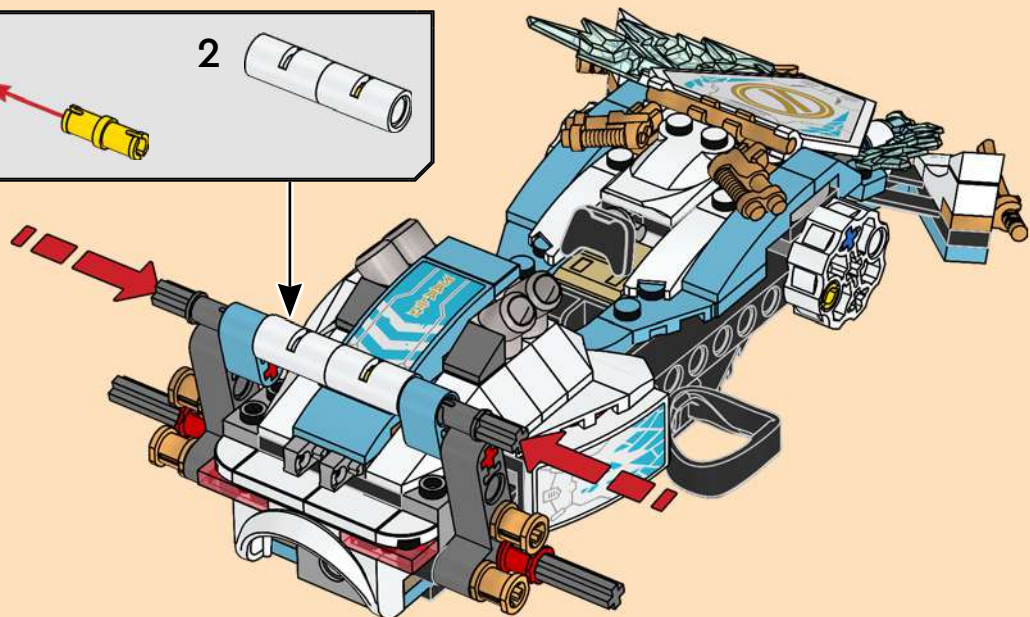
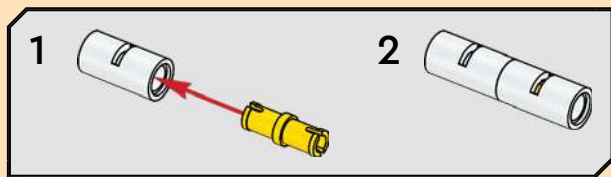

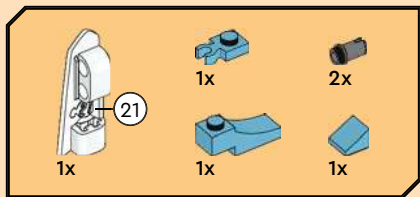

107

1

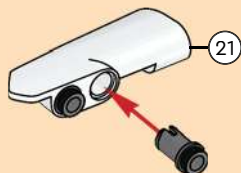

2

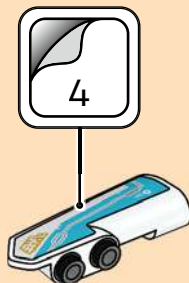

3

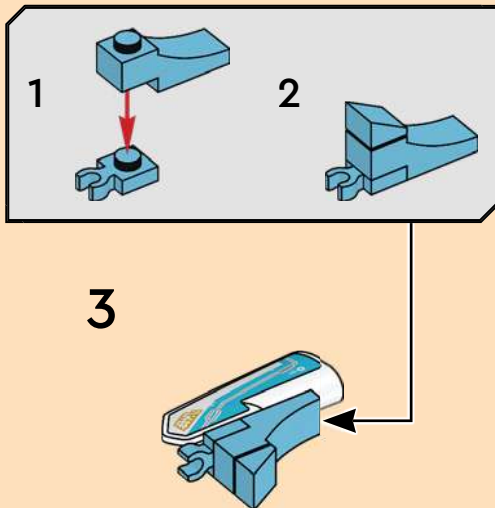

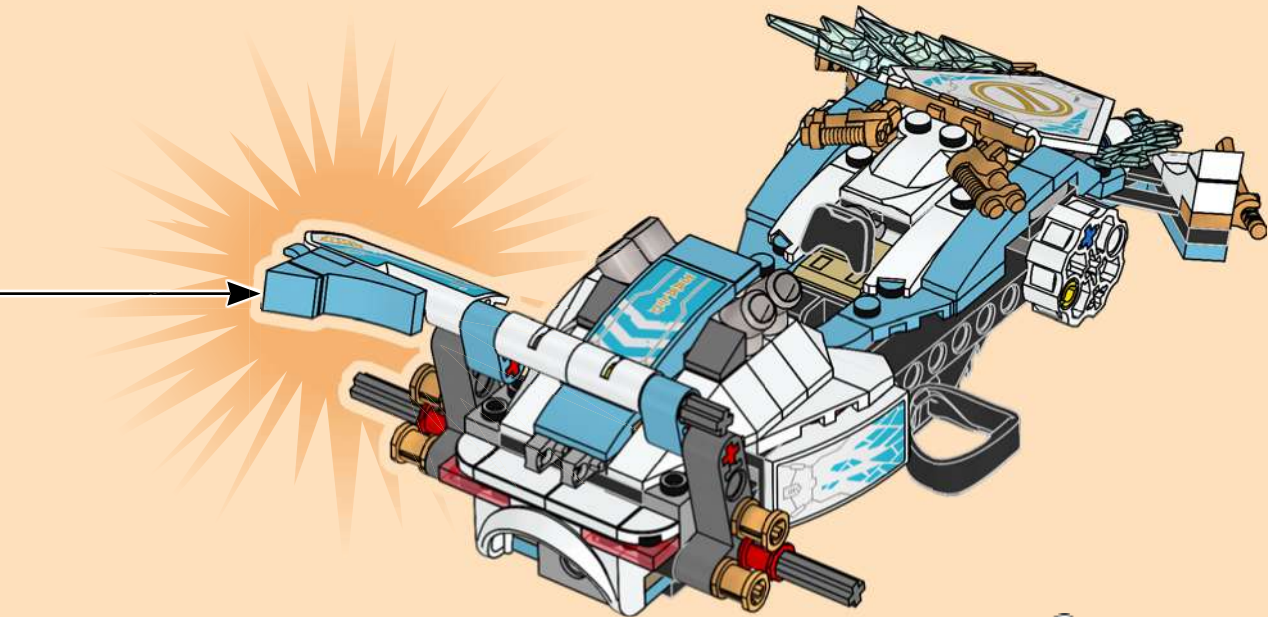

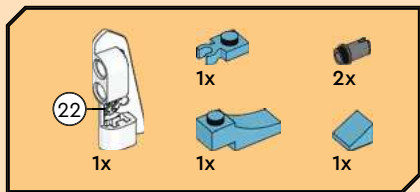

108

1

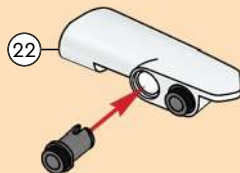

2

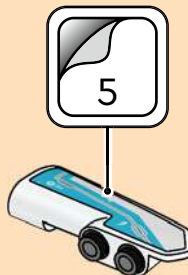

3

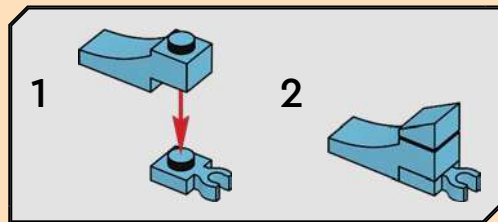
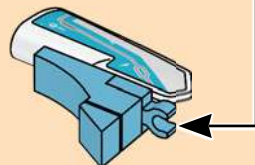

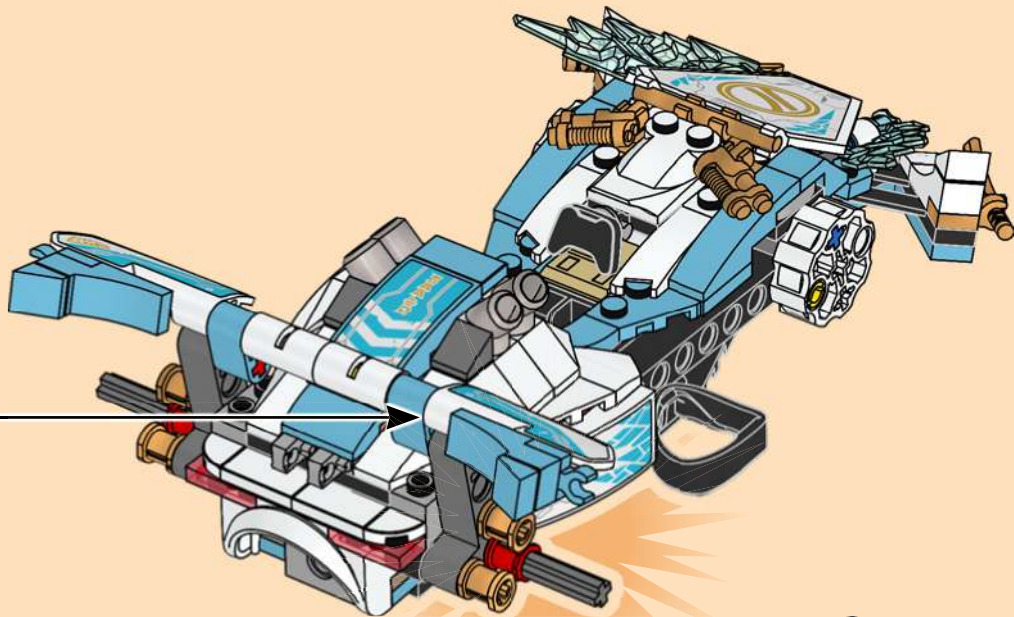



109

1

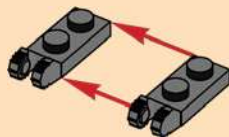

2



3

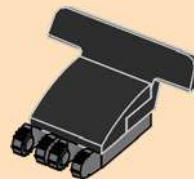

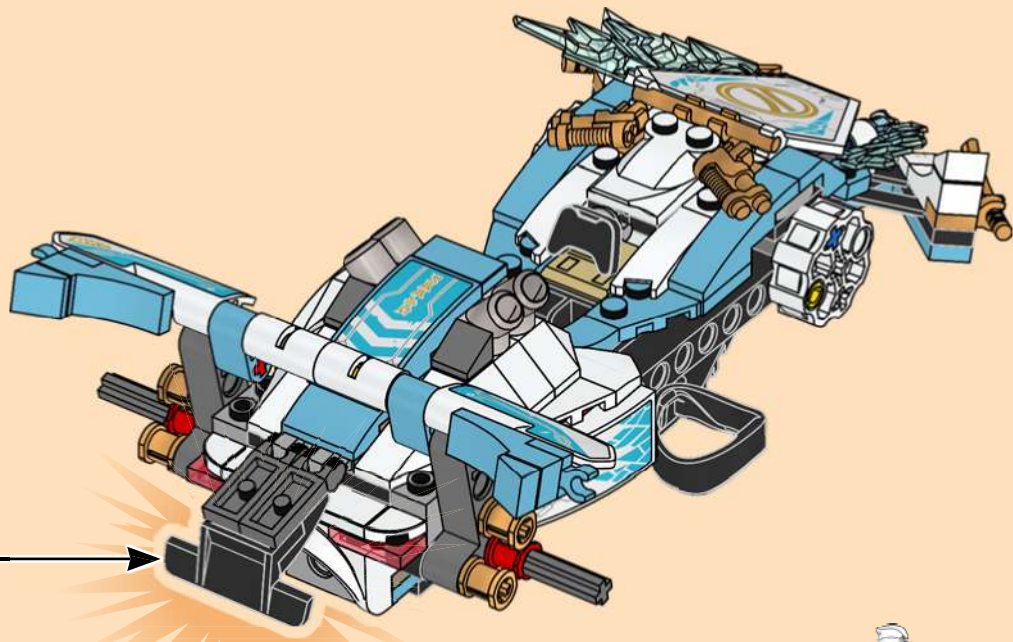

110

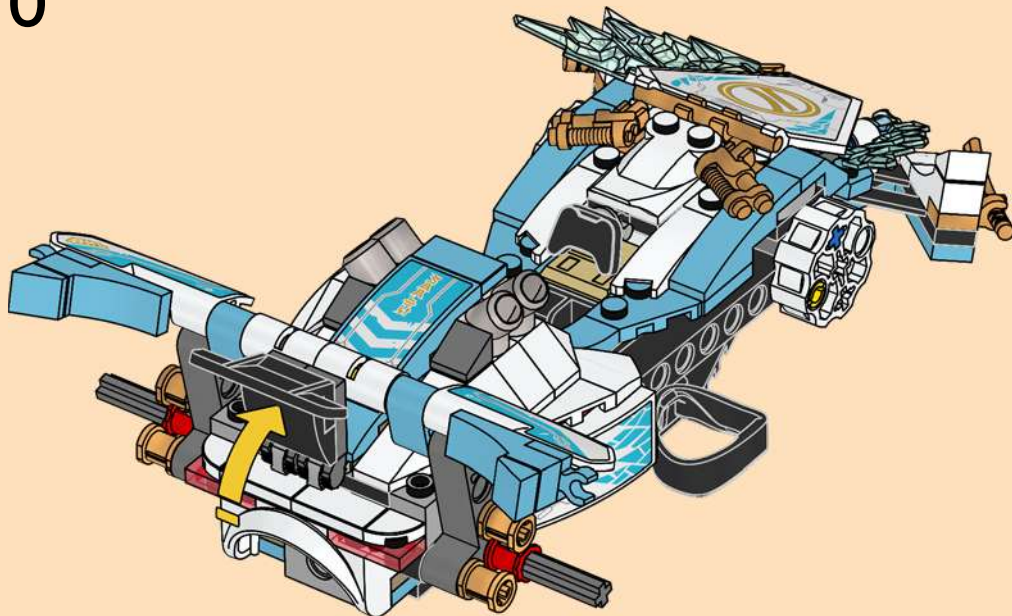



1x



1x

111

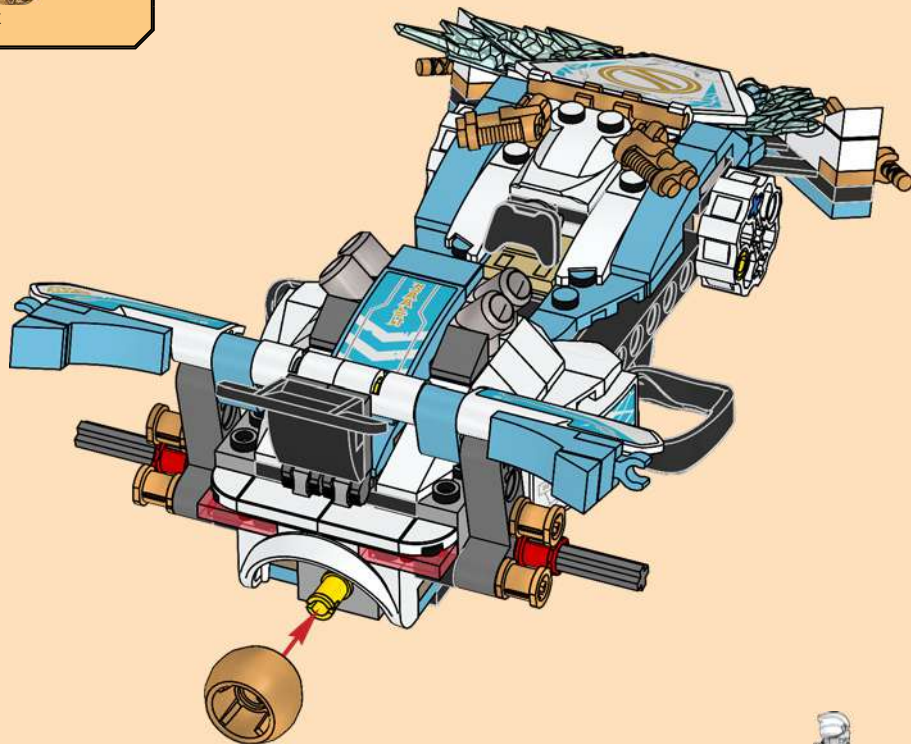

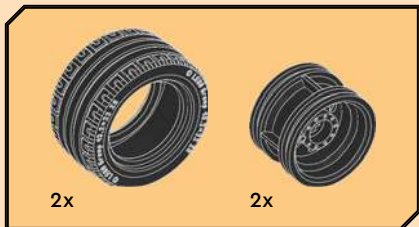

112

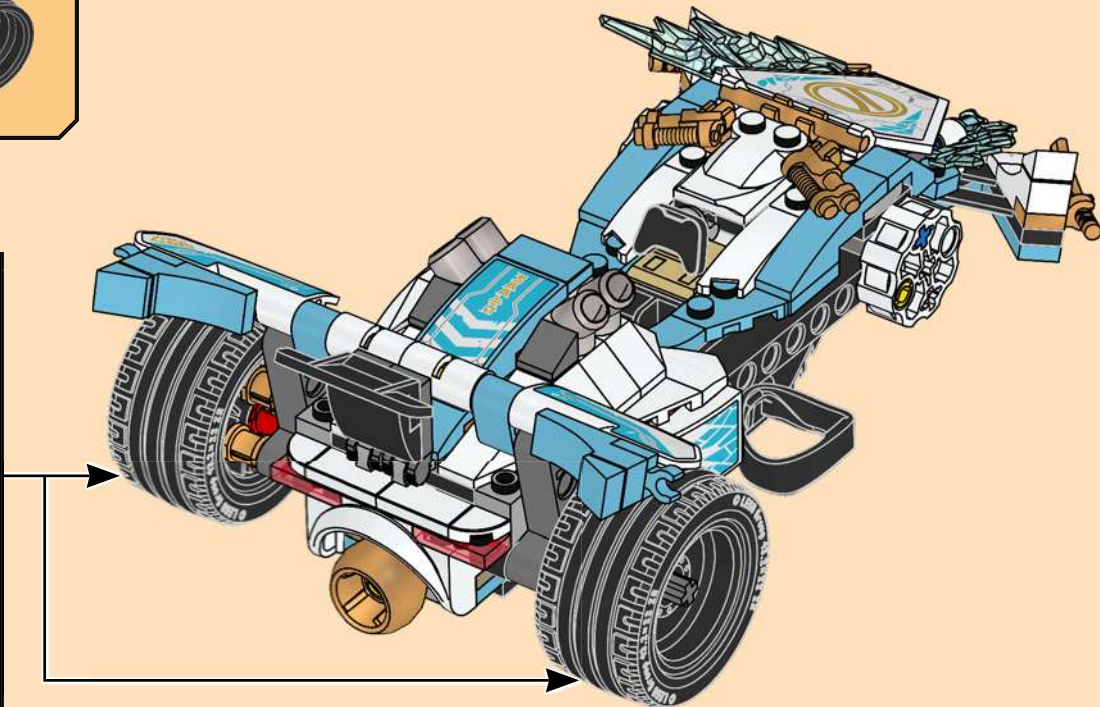
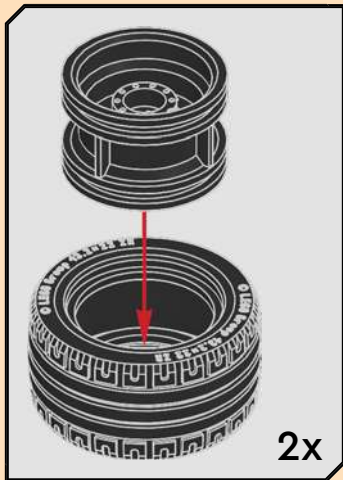



2x

113

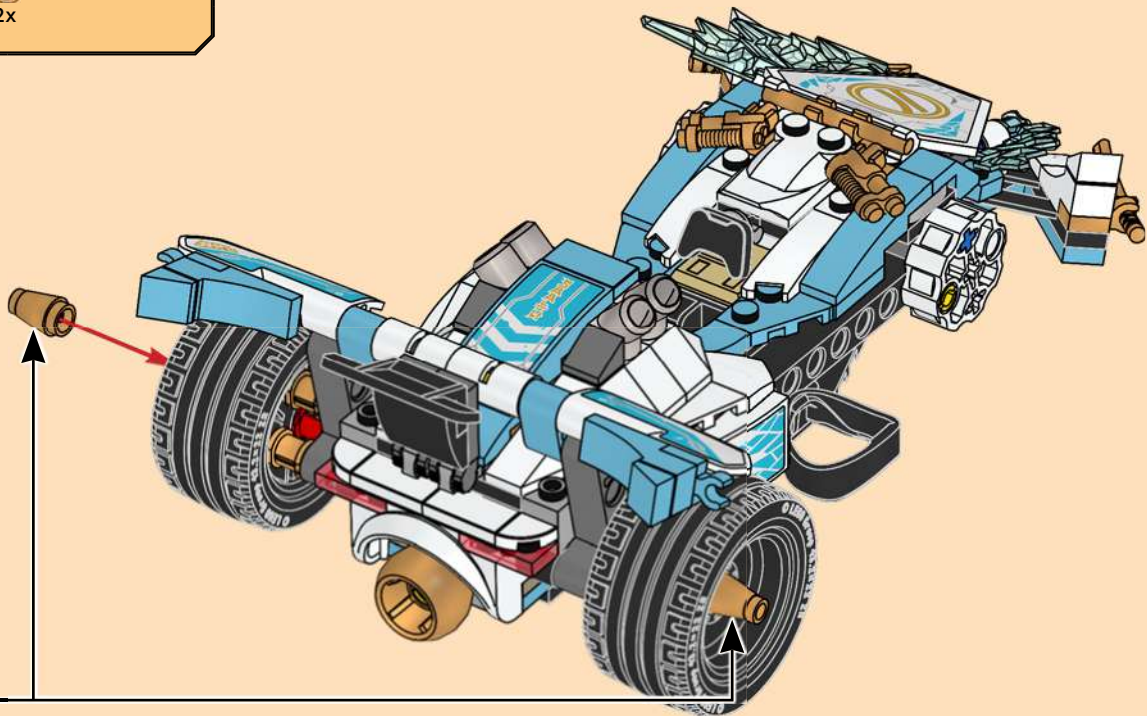

2x





114

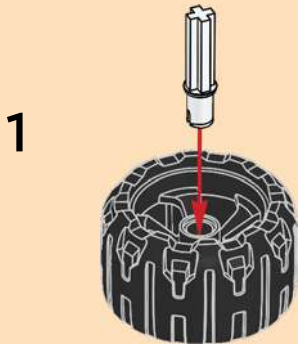

2x

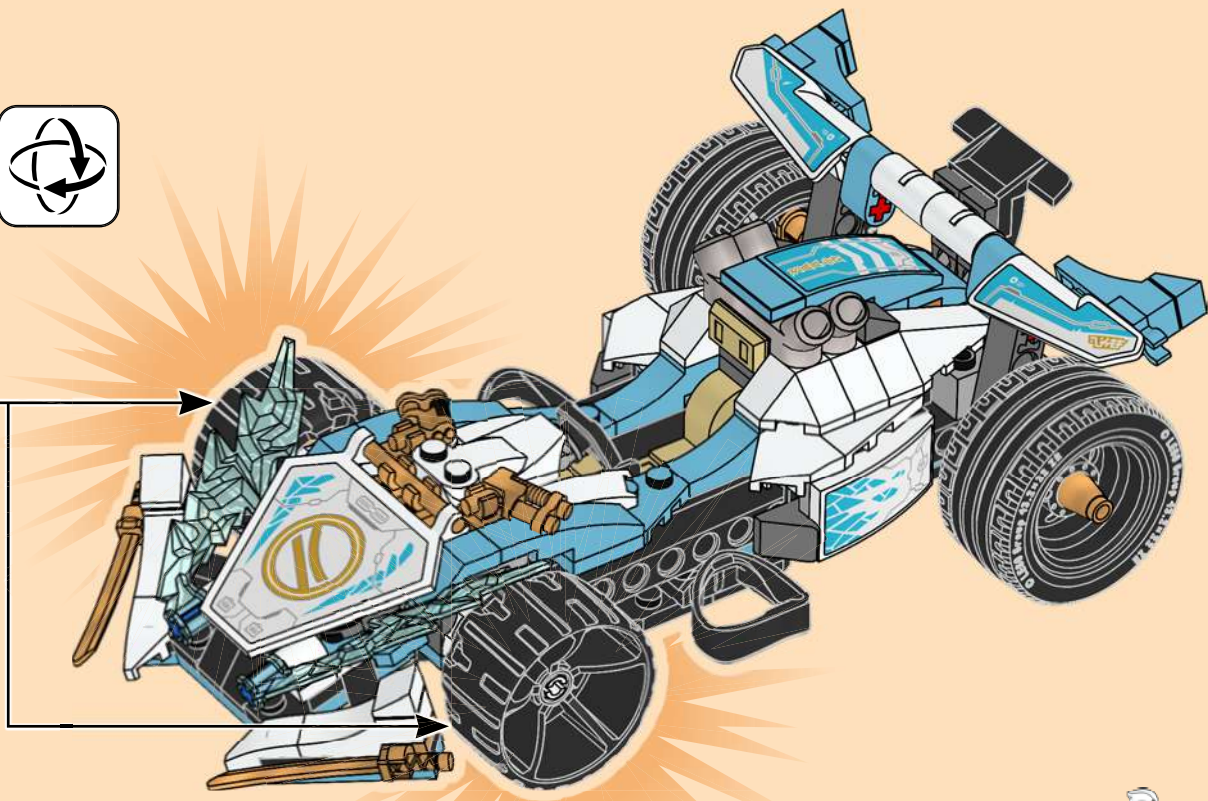



2x

115

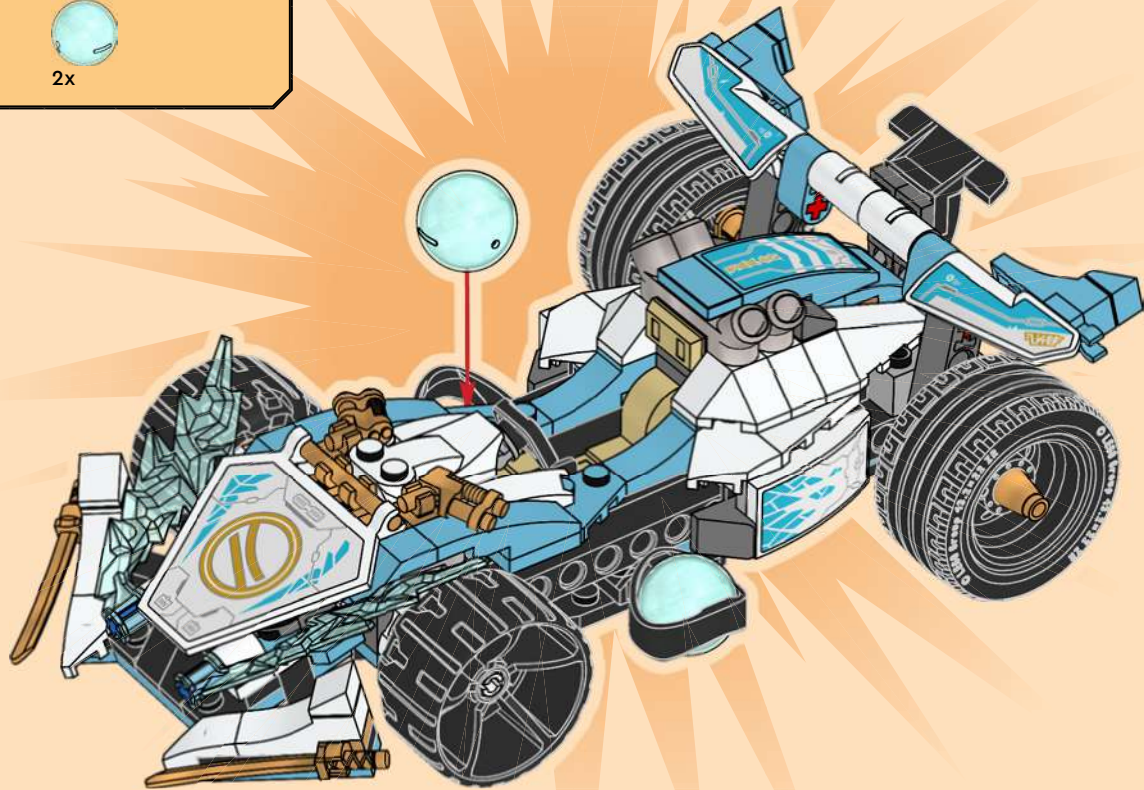

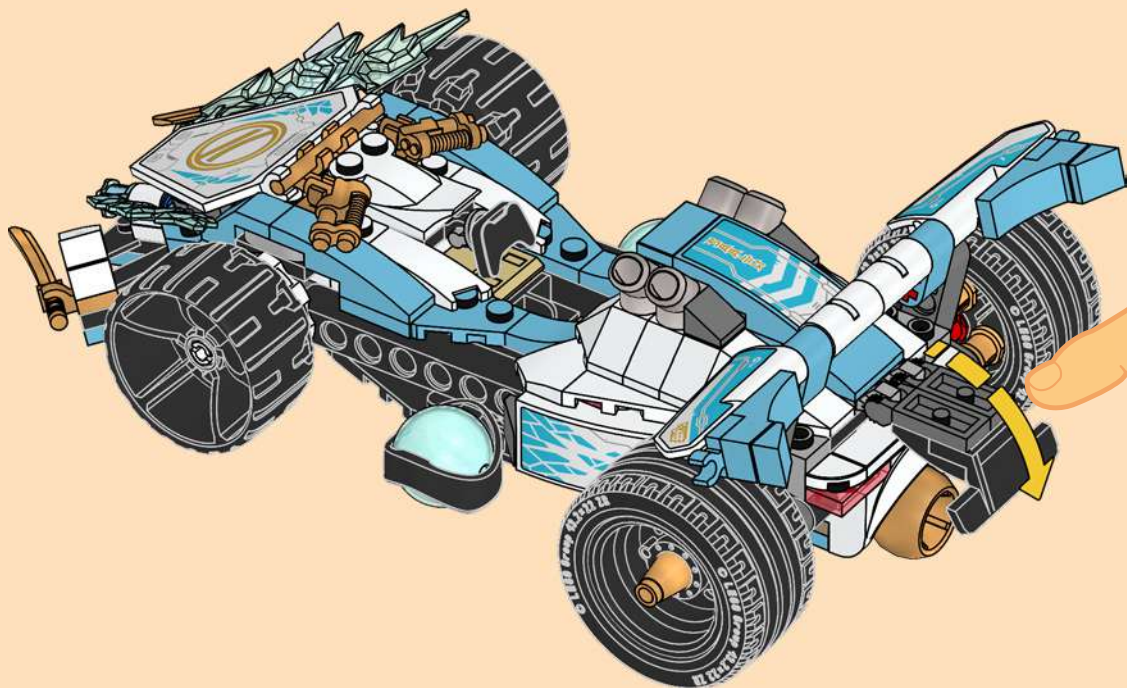

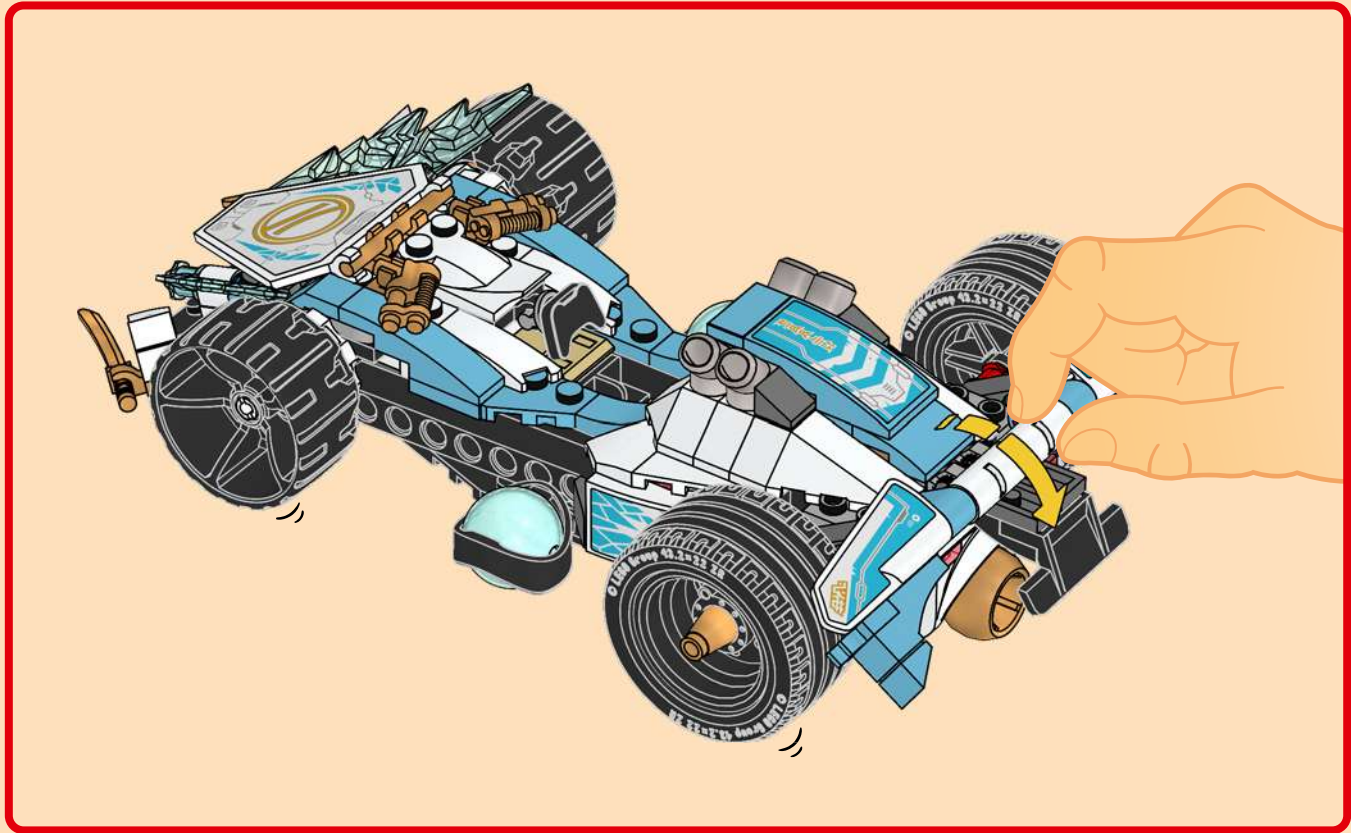

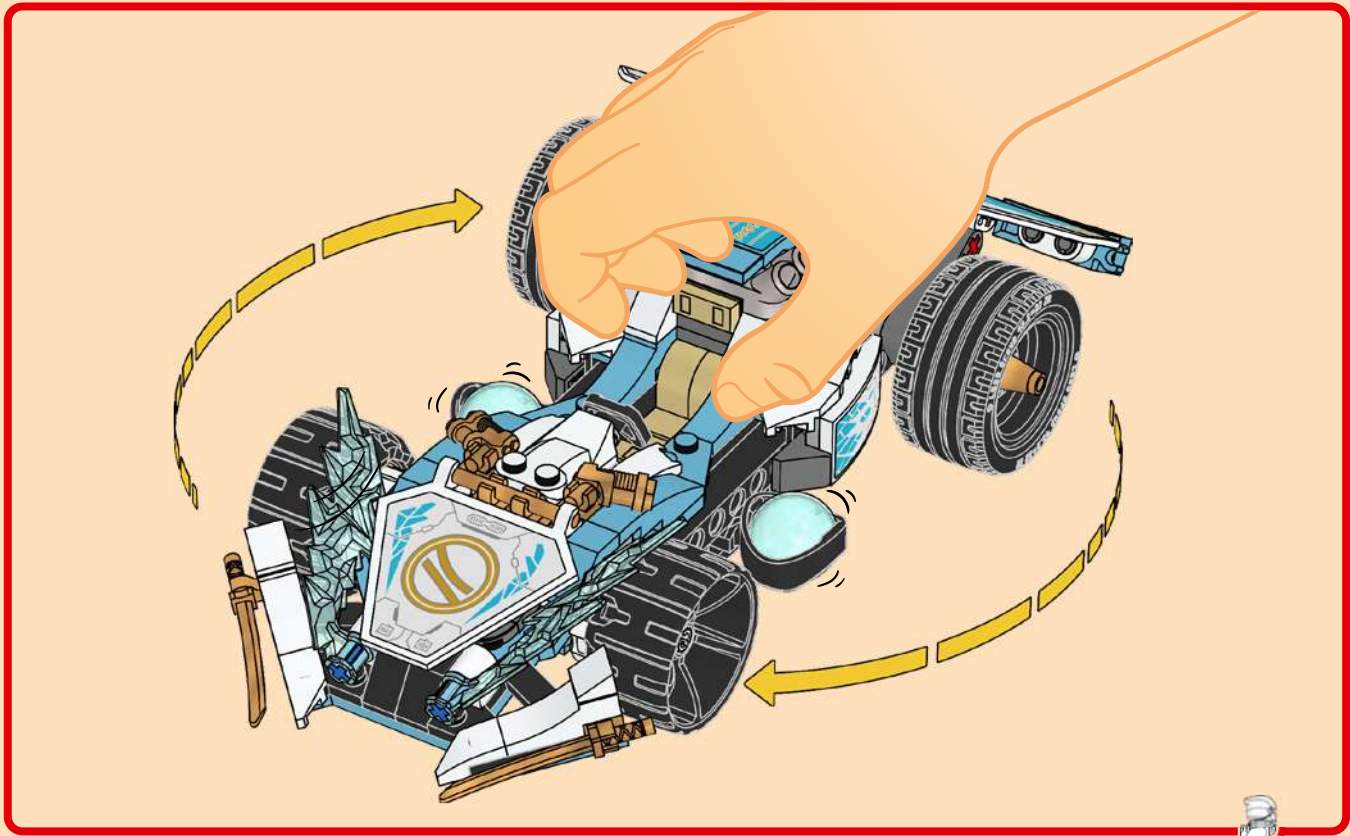



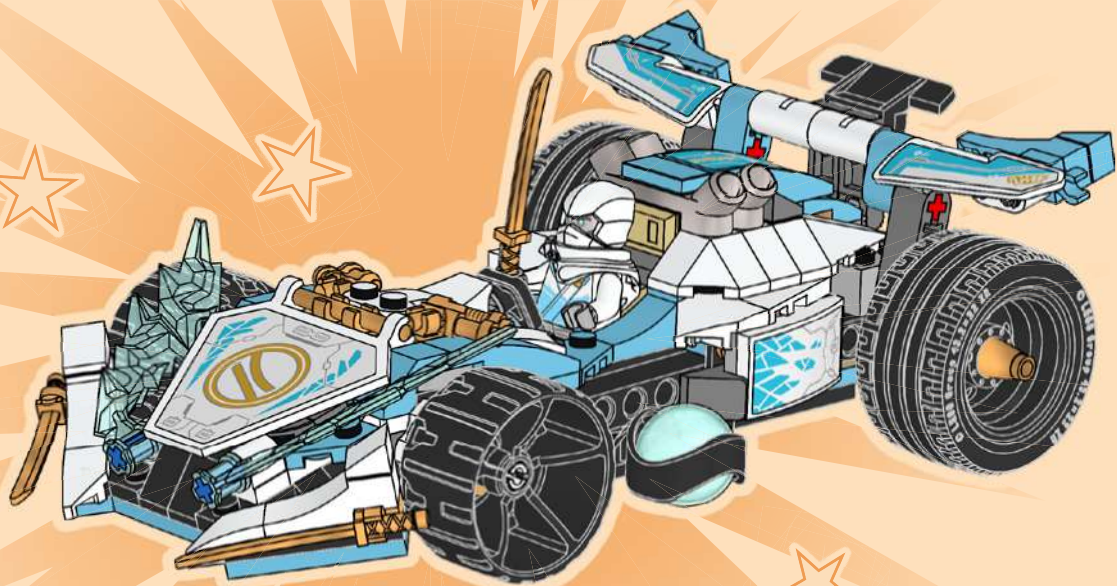



NINJAGO

DRAGONS RISING



71795



71791



71789



71797



71790



71798



71777



71778



71779



71799



71796



71792



71793



71794





1x 6199163	2x 4540386	2x 4211001	4x 6262138	2x 6335111	1x 6434450	2x 4619520	1x 4649741	2x 6070757
1x 6378136	2x 6069164	2x 6271830	2x 6426622	2x 6092594	4x 6331822	2x 6296842	2x 6296622	2x 6347671
2x 6443149	2x 6214341	2x 6271830	2x 6284379	4x 6388241	2x 6206240	2x 6296842	5x 4625032	1x 6441153
4x 6248890	2x 4210660	1x 4211085	2x 6433738	4x 6287672	2x 362324	2x 6296840	1x 6119126	1x 6441153
2x 4540203	2x 4211109	2x 6218084	1x 6434470	1x 6437933	1x 6024495	2x 6445843	4x 6320292	6x 4625036
2x 6266231	2x 6015356	2x 6218084	1x 6434470	1x 6430283	3x 6271228	2x 6249415	2x 6344813	1x 6141594
3x 6326478	2x 6267047	1x 6287680	1x 6434474	1x 6147169	2x 6411329	2x 4632100		
2x 6439405	2x 4225733	1x 6003147	1x 6403912	2x 6270138	1x 6117975	1x 6434440		
2x 6231765	1x 6395363	2x 4529247	1x 6403912	6x 6116596	1x 6330903			
4x 6395635	2x 6199549	2x 4523159	1x 6430284	1x 6116596	2x 6221467			
2x 6199549	2x 6083620	1x 6434472	2x 6323675	1x 6175943				
2x 4504378								

4

[LEGO.com/service](https://www.LEGO.com/service)

YOU COULD **WIN**



Scan this QR code or go to **LEGO.COM/PRODUCTFEEDBACK** and give us your short feedback about this LEGO® set for a chance to win a cool LEGO prize.

Terms and Conditions apply*



EN: YOU COULD WIN. Terms and Conditions apply* **DE: Du könntest GEWINNEN.** Es gelten die Teilnahmebedingungen* **FR: Tu pourrais GAGNER.** Des conditions s'appliquent* **IT: Potresti VINCERE tu.** Termini e condizioni sono applicabili* **ES: Puedes GANAR.** Aplican términos y condiciones* **PT: Poderá GANHAR.** Aplicam-se termos e condições* **ZH: 轻松获奖. 条款和条件适用*** **PL: Szansa na WYGRANĄ.** Obowiązują warunki korzystania* **CS: Máte šanci VYHRÁT.** Platí všeobecné smluvní podmínky* **SK: Máte šancu VYHRAŤ.** Platia všeobecné zmluvné podmienky* **HU: TE IS NYERHETSZ.** Felhasználási feltételek érvényesek* **RO: Ai putea CÂȘTIGA.** Se aplică termenii și condiții* **BG: Можете да СПЕЧЕЛИТЕ.** Има определени правила и условия* **LV: Tu vari LAIMĒT.** Ir spēkā noteikumi un nosacījumi.* **ET: Sul on võimalus VÕITA.** Kehtivad tingimused* **LT: Jūs galite LAIMĖTI.** Taikomos sąlygos*

*[LEGO.com/productfeedback-terms](https://www.lego.com/productfeedback-terms)

LEGO, the LEGO logo and NINJAGO are trademarks of the LEGO Group. ©2023 The LEGO Group.

6488666