



# CREATOR™

# 3 IN 1

31137



3 in 1	3 w 1	"3 в 1"
3 en 1	3 v 1	Kolm ühes
3 em 1	3 az 1-ben	3 vienne
3 合 1	3 in 1	



[LEGO.com/sustainable-packaging](https://LEGO.com/sustainable-packaging)



# BUILDER



Apple and the Apple logo are trademarks of Apple Inc., registered in the U.S. and other countries and regions. App Store is a service mark of Apple Inc. Google Play and the Google Play logo are trademarks of Google LLC. Tencent and the Tencent logo are trademarks of Tencent Inc.

**EN** Ask parents' permission before going online | **DE** Eltern um Erlaubnis bitten, bevor du online gehst | **FR** Demande l'autorisation d'un parent avant d'aller en ligne | **IT** Chiedi il permesso ai tuoi genitori prima di andare online | **ES** Pídeles permiso a tus papás antes de conectarte a Internet | **PT** Pede autorização aos pais antes de acederes online | **JA** オンラインになる前に ほか者の方のきよかをもらおう | **ZH** 上网前应先征得父母的同意 | **KO** 온라인 접속 전에 보호자 동의가 필요합니다 | **RU** Спроси разрешения у родителей, прежде чем заходить в интернет | **PL** Poproś rodziców o zgodę, zanim wejdziesz do Internetu | **CS** Než půjdeš na internet, požádej rodiče o svolení | **SK** Skôr než pôjdeš na internet, vypýtaj si povolenie od rodičov | **HU** Kérj szülői engedélyt, mielőtt online csatlakoznál! | **RO** Cere permisiunea părinților înainte de a te conecta online | **BG** Поискайте разрешение от родител, преди да влезете онлайн | **LV** Pirms došanās tiešsaistē palūdz atļauju vecākiem | **ET** Enne Interneti kasutamist küsi vanematelt luba | **LT** Prieš prisijungdami prie interneto, atsklauskite tėvų

[LEGO.com/devicecheck](https://www.lego.com/devicecheck)

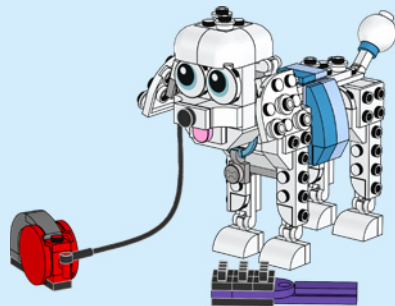
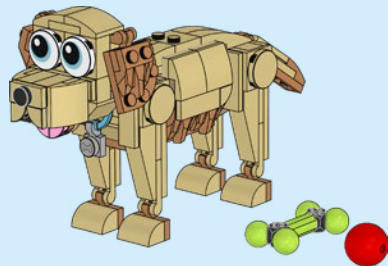
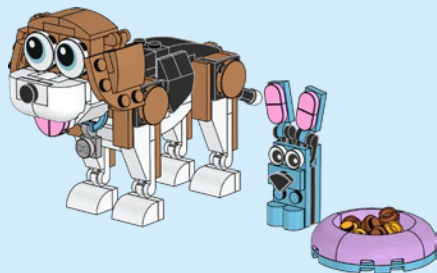
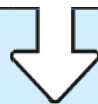
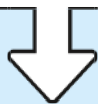
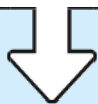

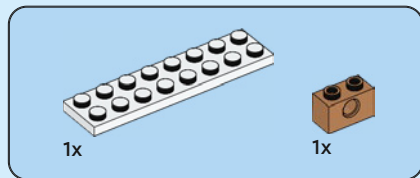
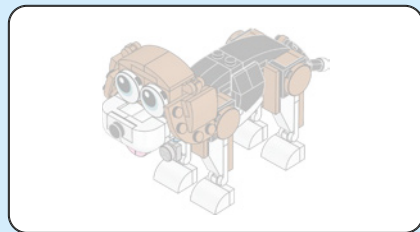

1

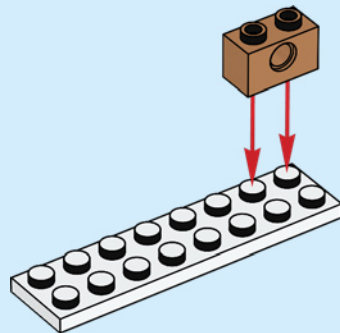



1x

2

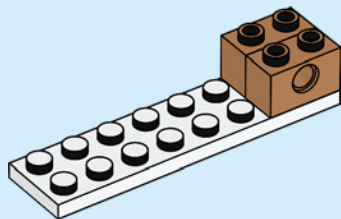

1x



1x

3

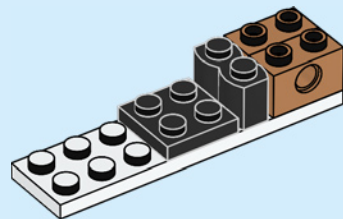



1x



2x

4

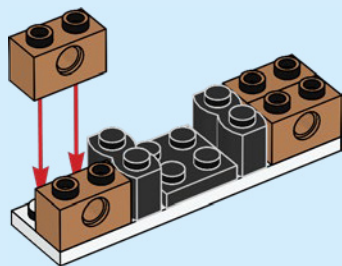

2x



1x



1x

5

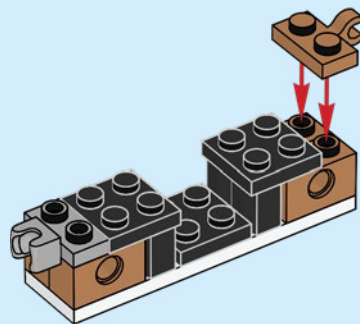

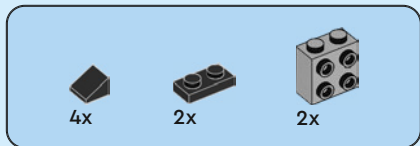

6

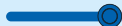
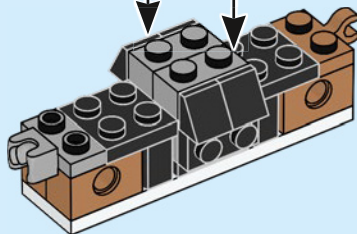
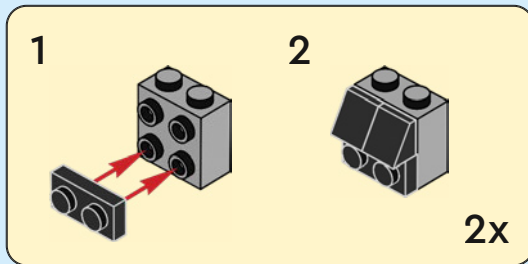





2x

7

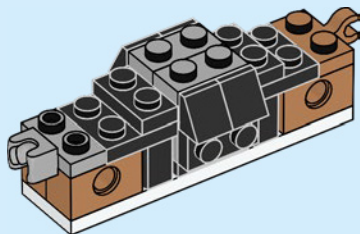

1x

8

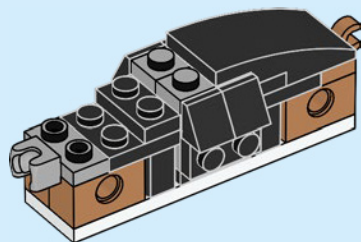



1x



2x

9

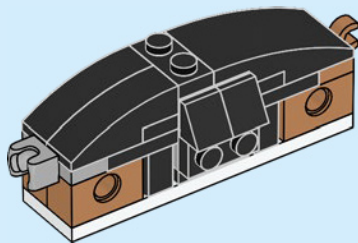

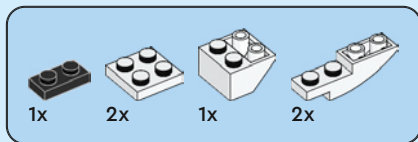

10

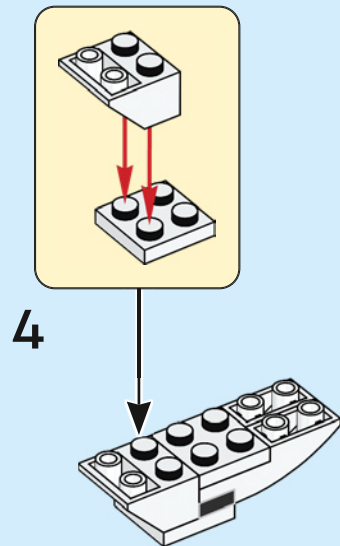
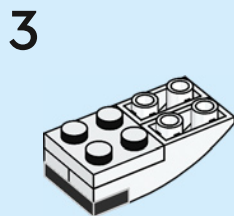
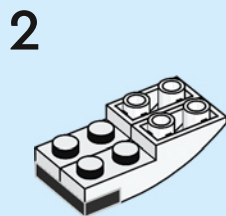
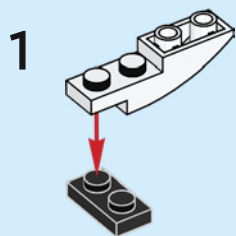

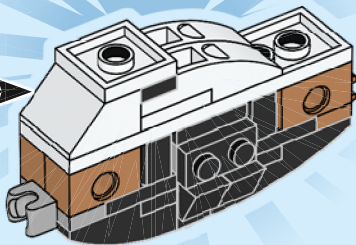

11

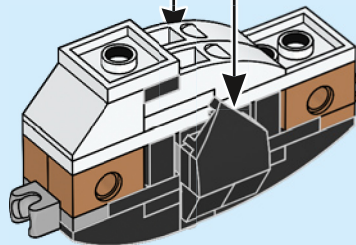
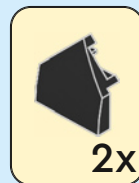

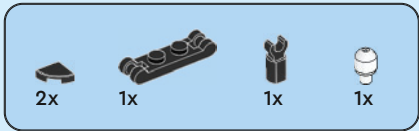

12

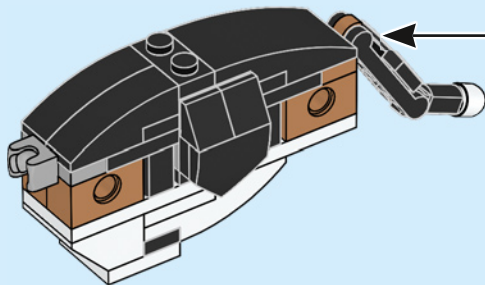
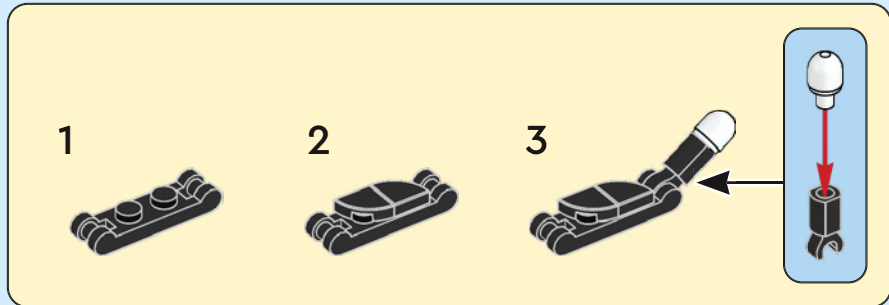

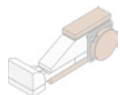

2x



1x



1x

13

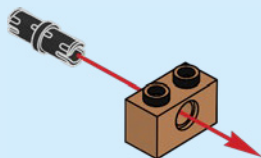

1x

14

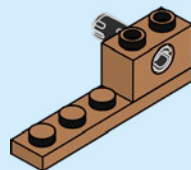

1x



1x

15

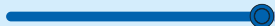
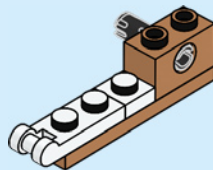

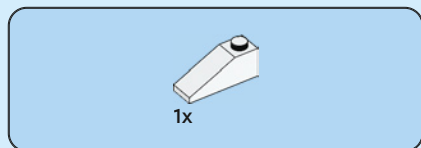

16

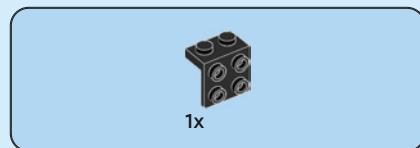
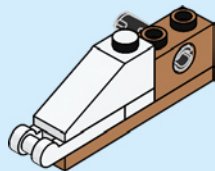

17

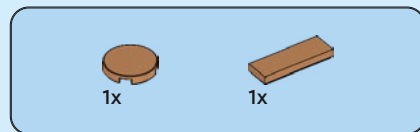
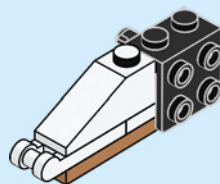

18

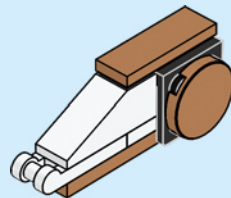

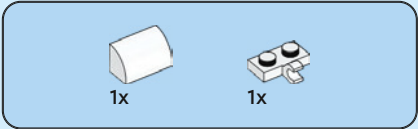

19

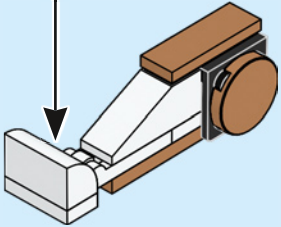
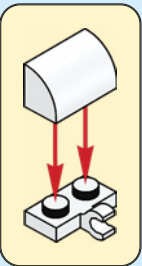

2x

20

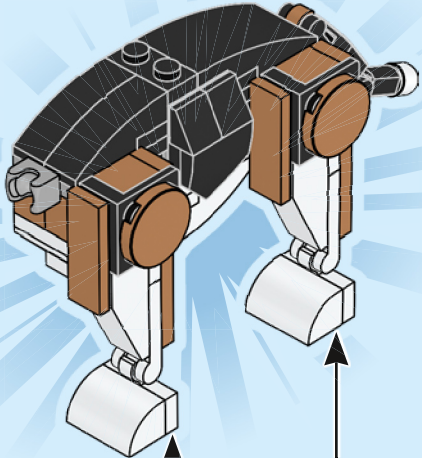



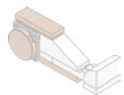

2x



1x



1x

21

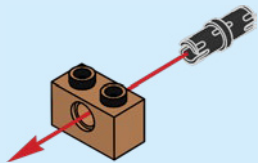

1x

22

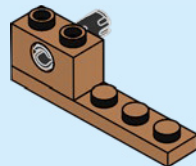

1x



1x

23

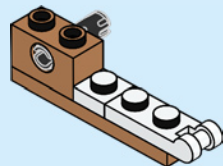



1x

# 24

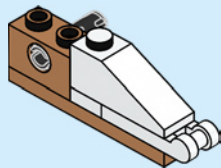

1x

# 25

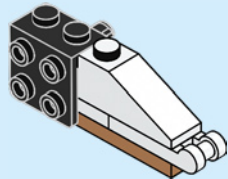

1x



1x

# 26

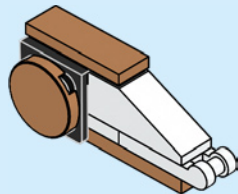



1x



1x

27

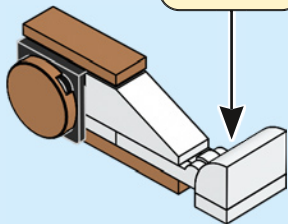
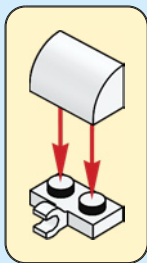

2x

28

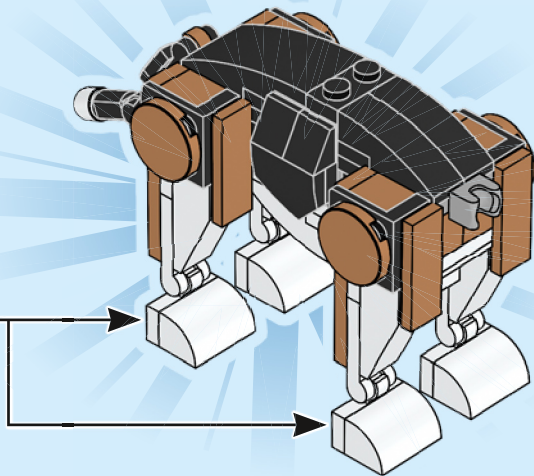
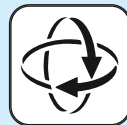

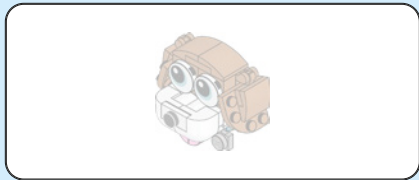

29

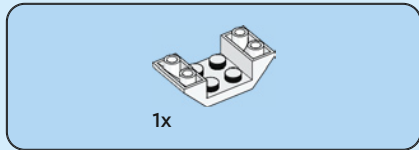
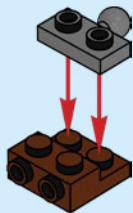

30

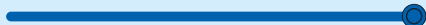
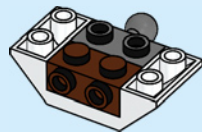

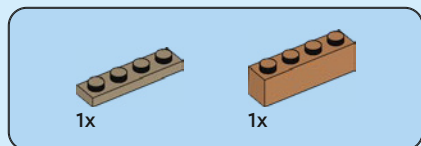

31

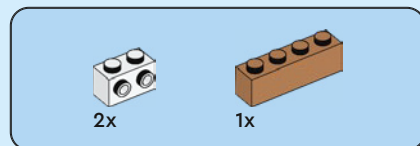
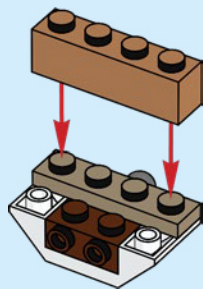

32

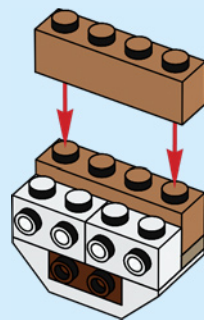



2x

33

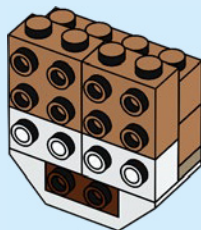

2x

34

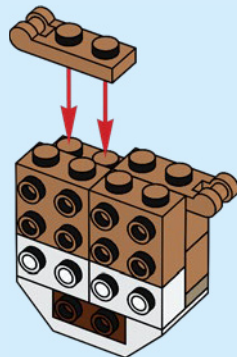



1x

35

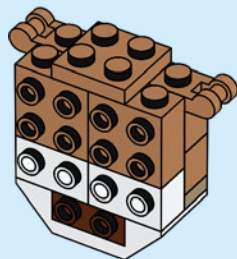

2x

36

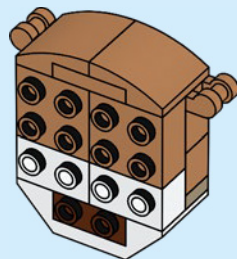

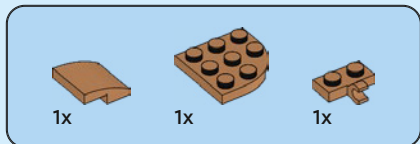

37

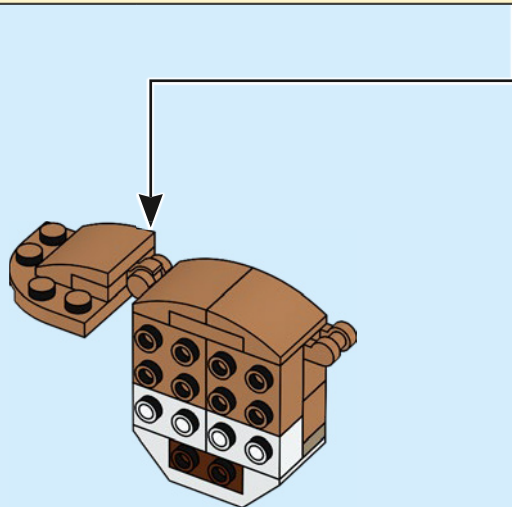
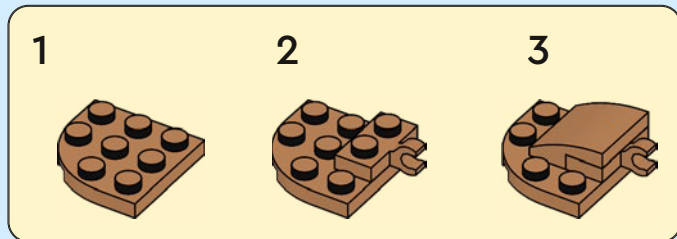



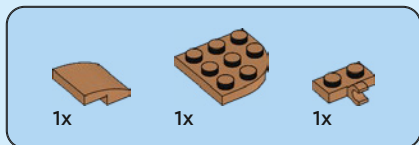

38

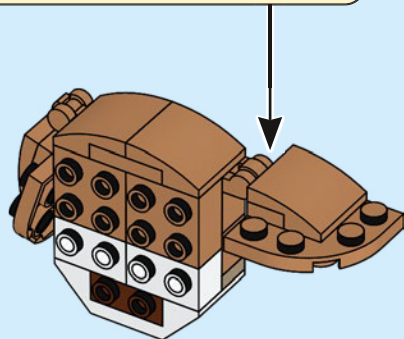



2x

39



2x



1x



1x

40

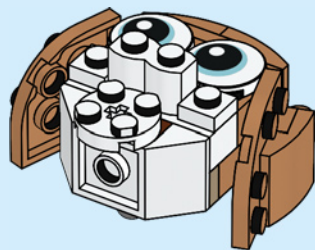



2x

41

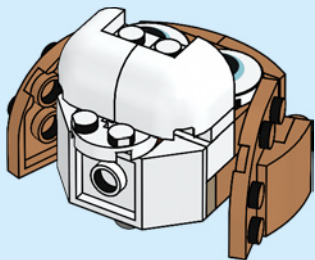

1x



1x

42

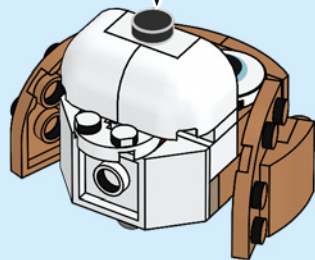
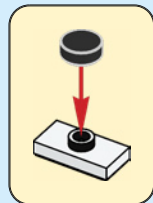



2x

43

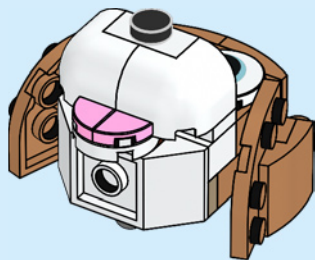

1x



1x



1x

44

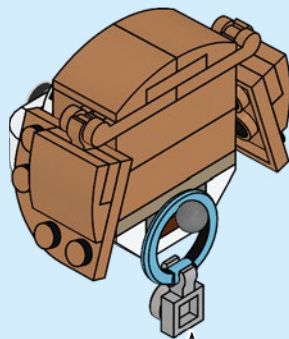

1



2

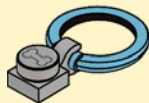

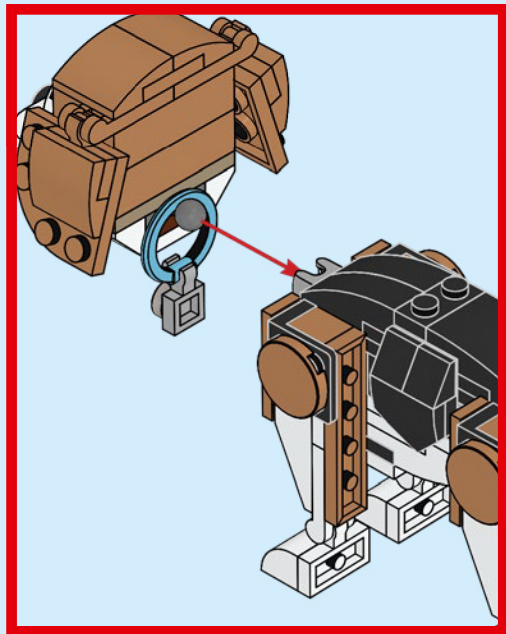

45

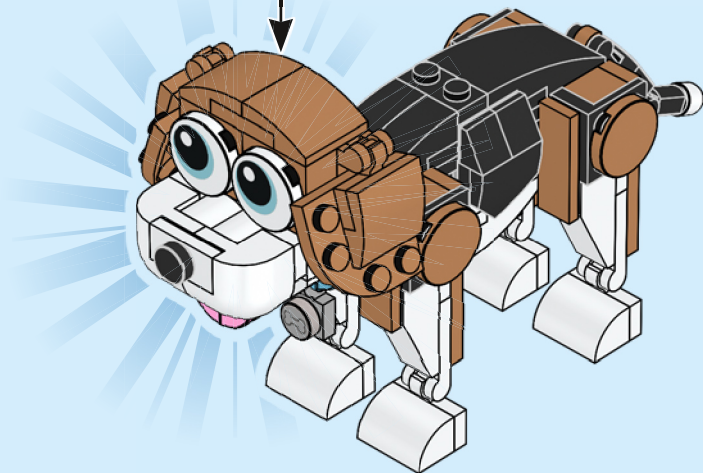

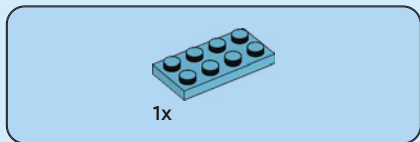

1x

1

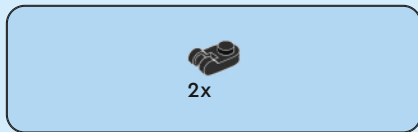
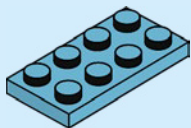

2x

2

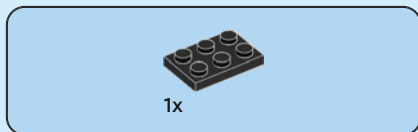
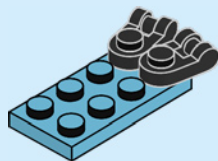

1x

3

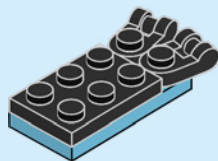

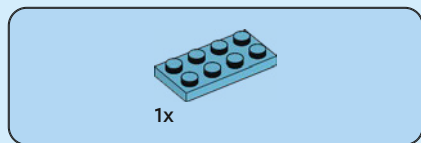

4

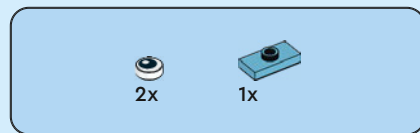
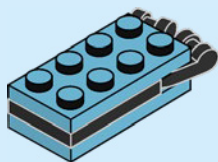

5

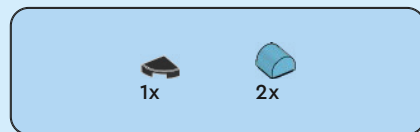
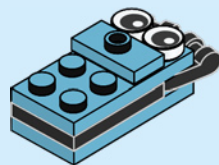

6

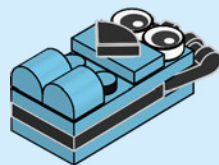

4x

2x

7

1

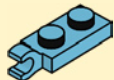

2

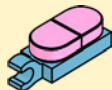

2x

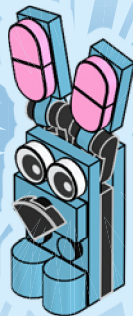
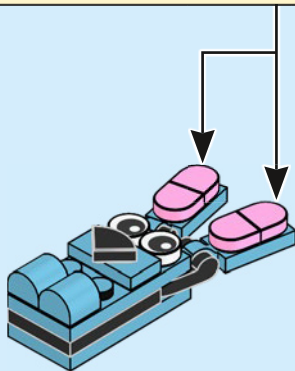



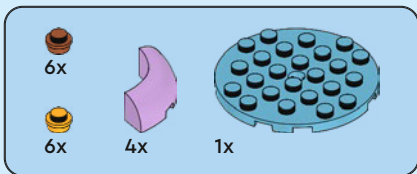

1

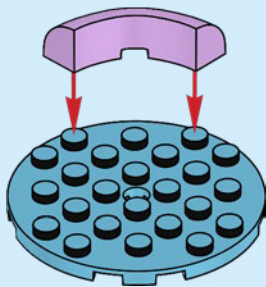

2

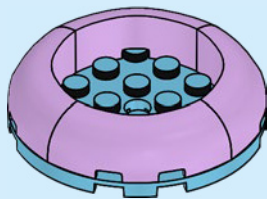

3



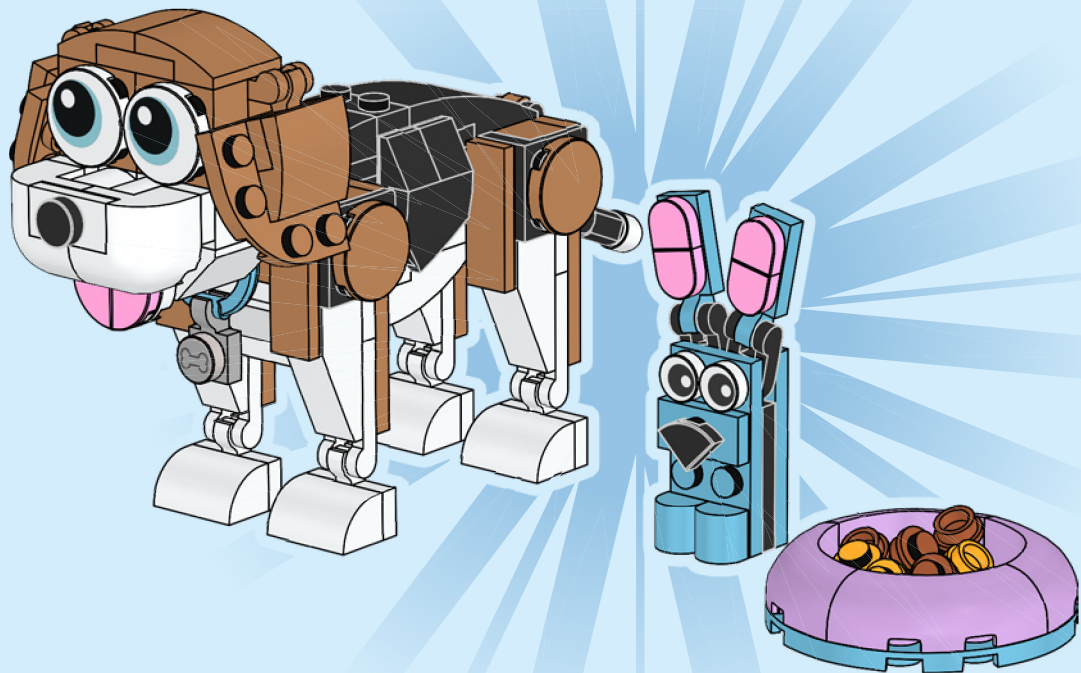

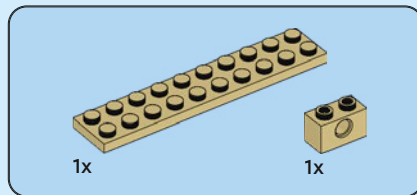
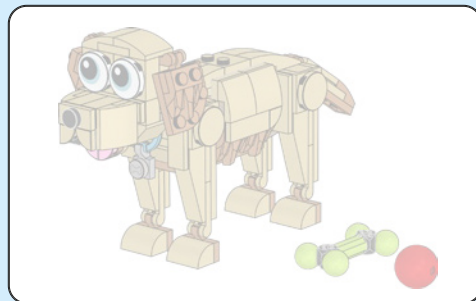

1

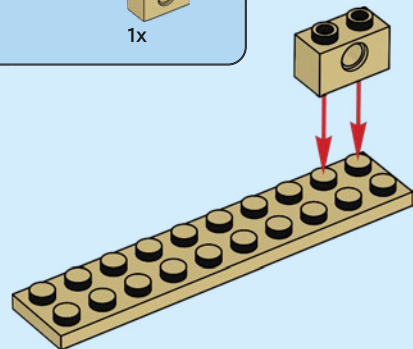



1x

2

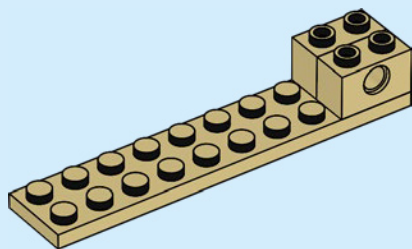

1x



2x

3

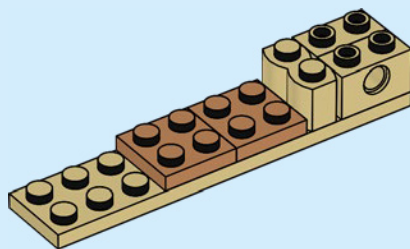



2x



1x

4

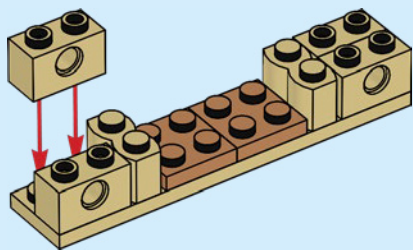

1x



2x



1x

5

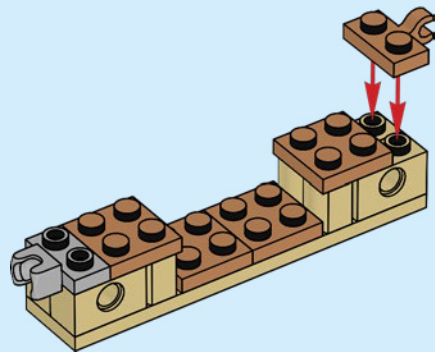



4x

6

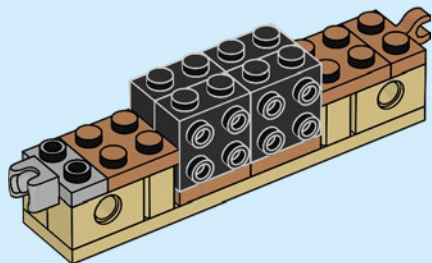

2x

7

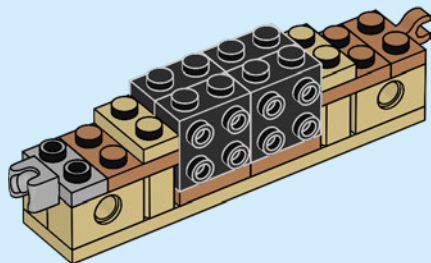

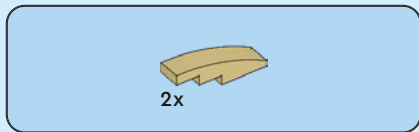

8

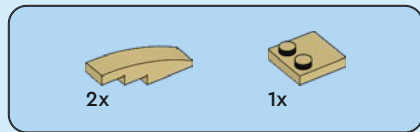
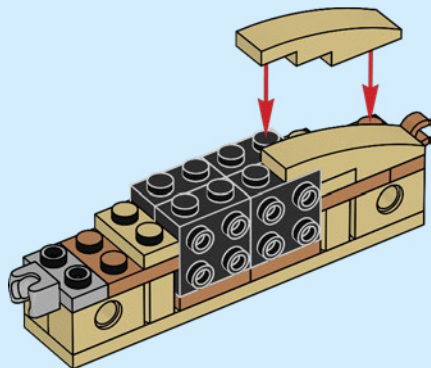

9

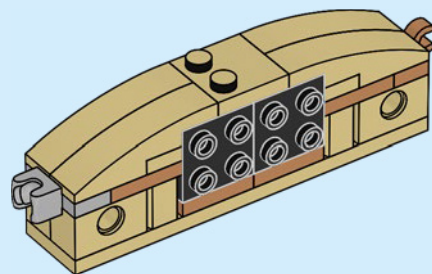

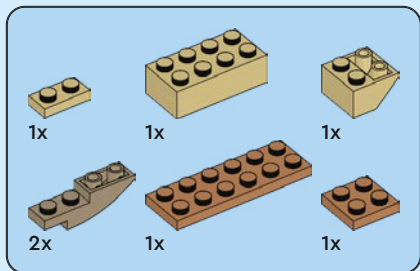

10

1

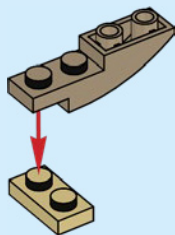

2

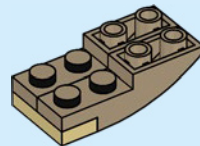

3

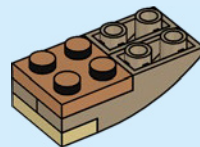



4

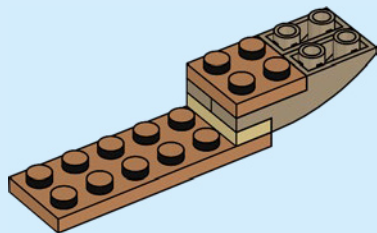

5

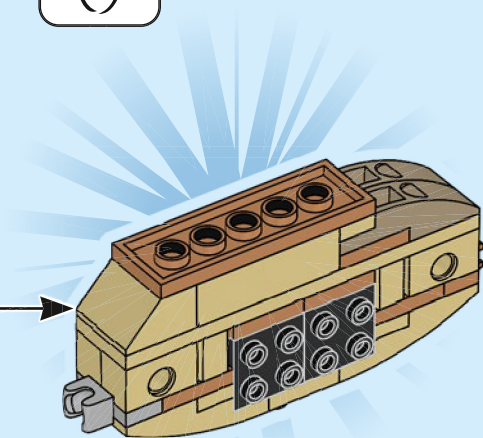
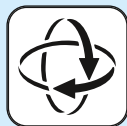
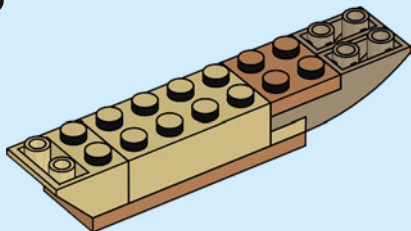

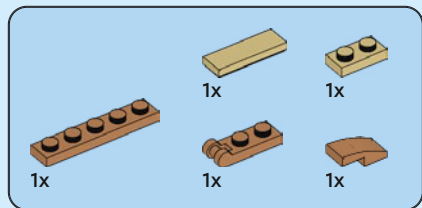

11

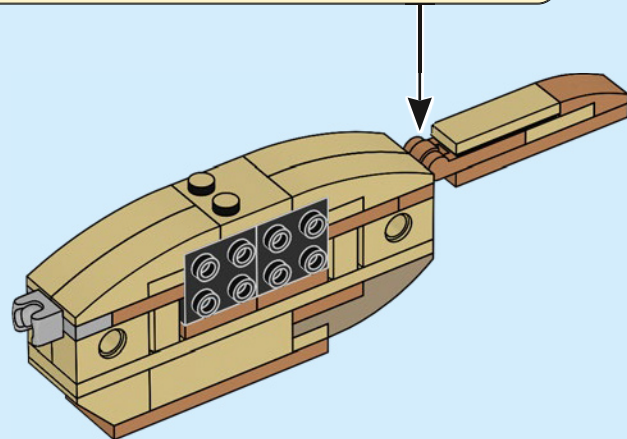
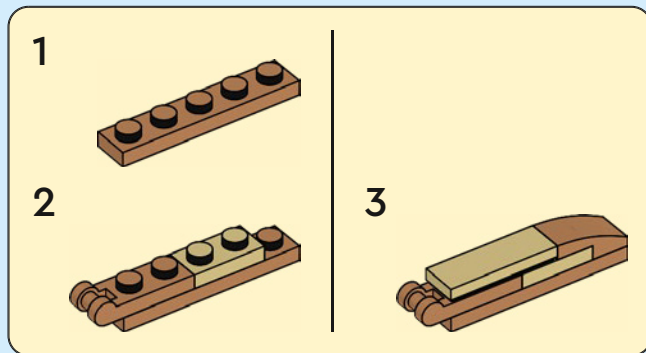

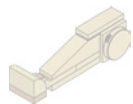

2x



1x



1x

12

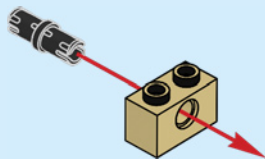

1x

13

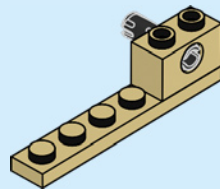

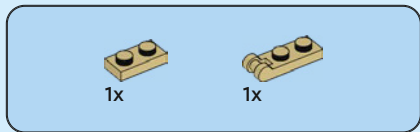

14

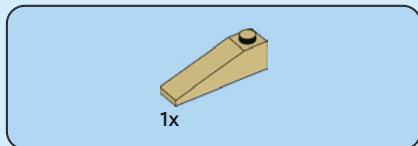
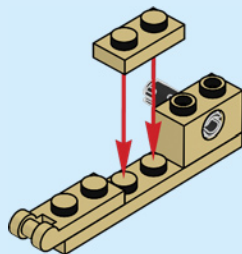

15

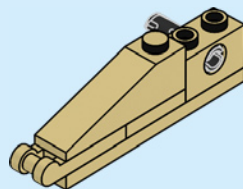



1x

16

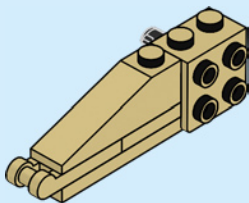

1x



1x

17

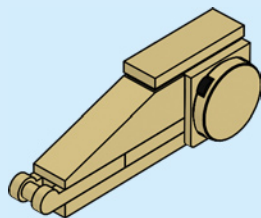

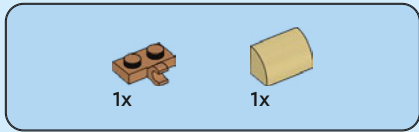

18

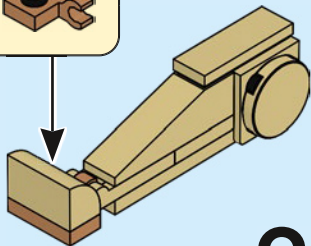
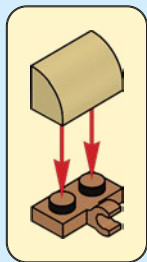

2x

19

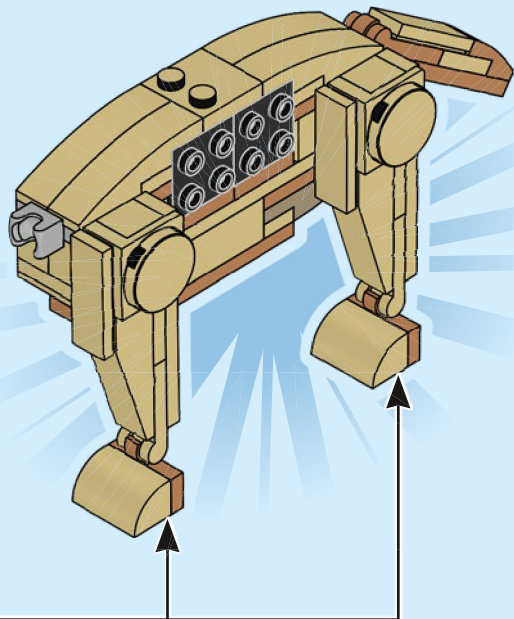

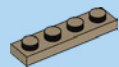

1x

20

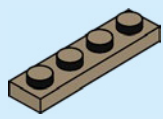

2x

21

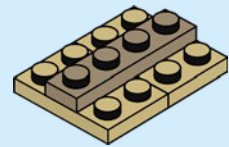



2x

22

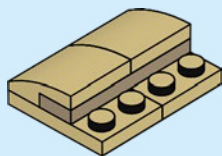

2x

23

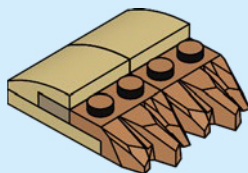



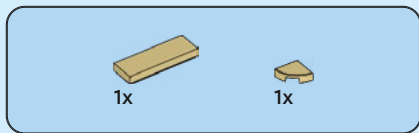

24

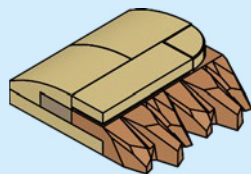

25

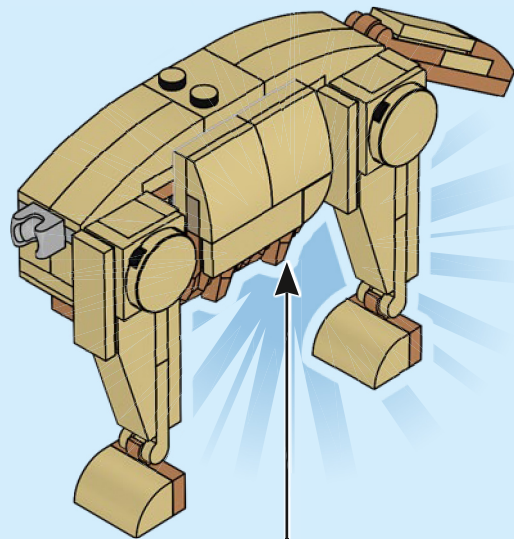

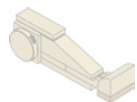

2x



1x



1x

26

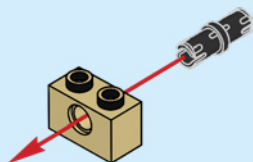

1x

27

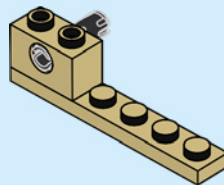



1x



1x

# 28

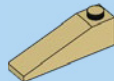
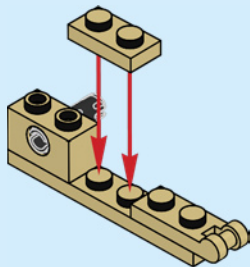

1x

# 29

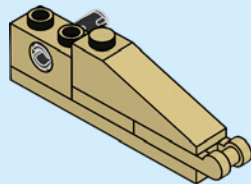



1x

30

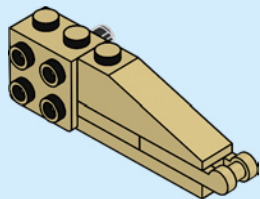

1x



1x

31

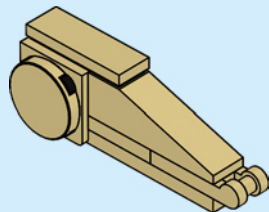

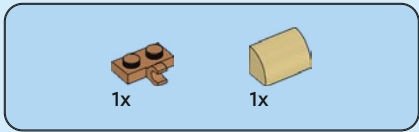

32

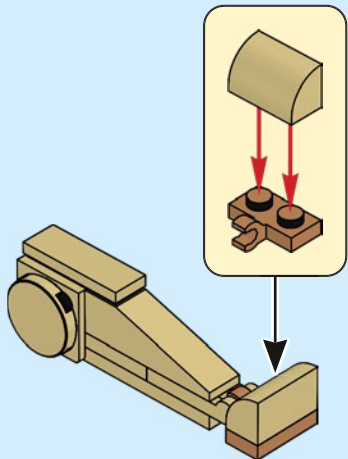

33

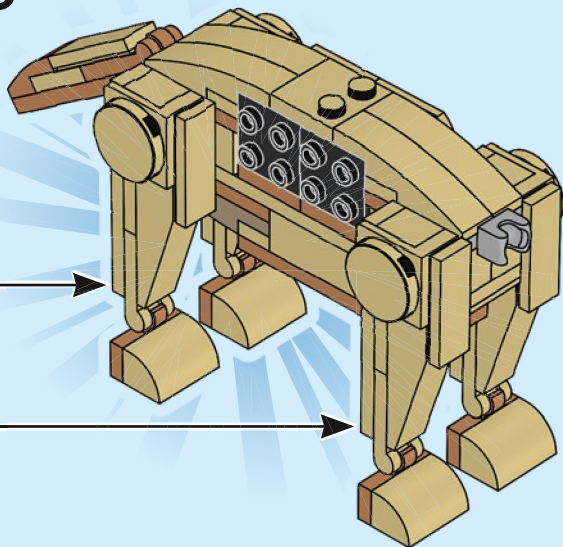
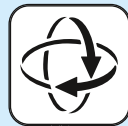

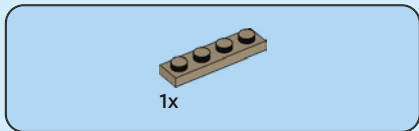

34

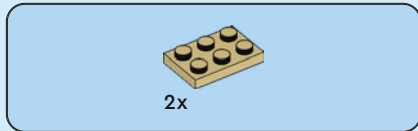
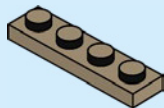

35

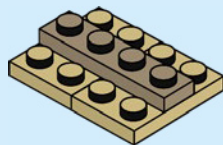



2x

36

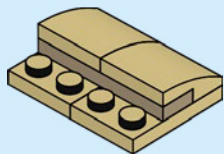

2x

37

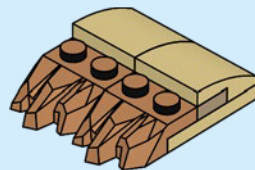

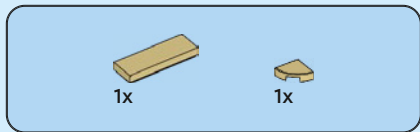

38

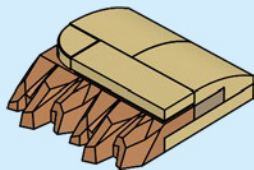

39

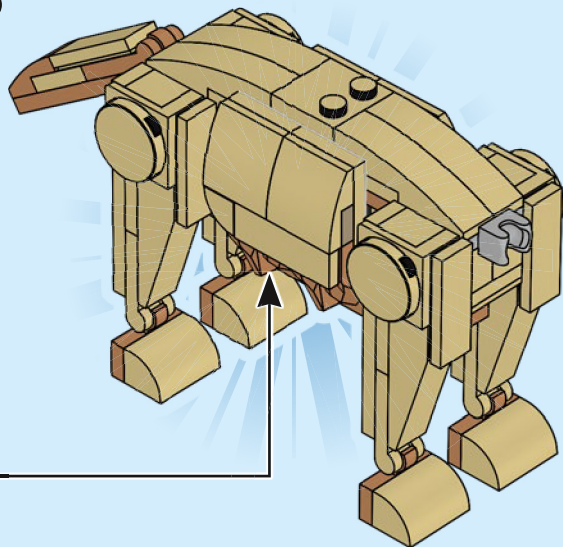



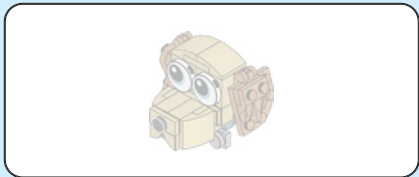

40

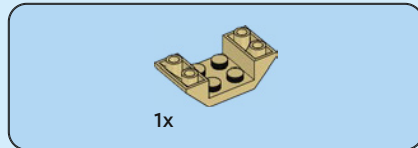
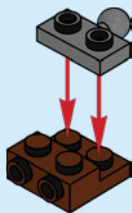

41

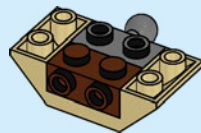

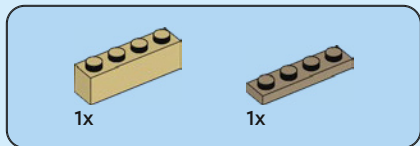

42

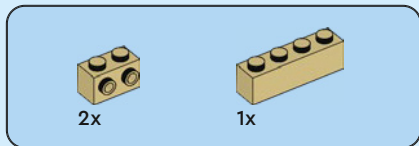
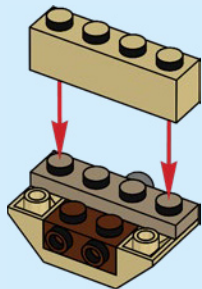

43

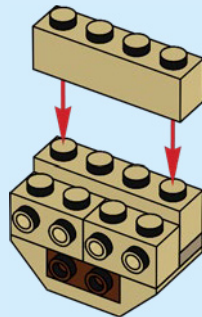



2x

44

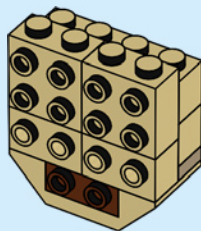

2x

45

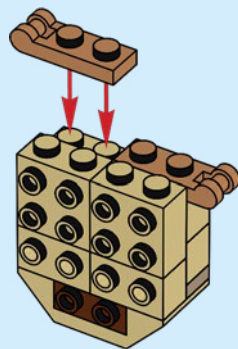



1x

46

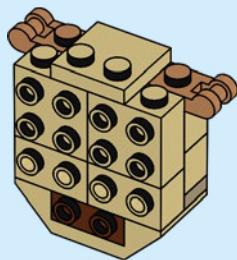

2x

47

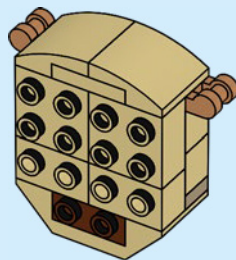

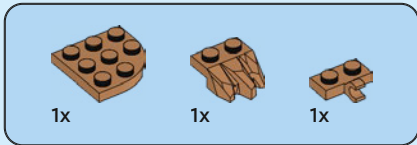

48

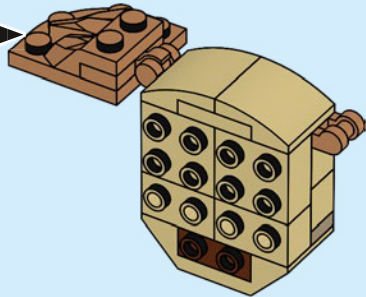
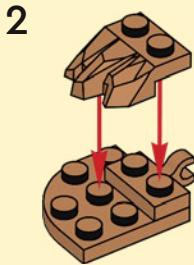
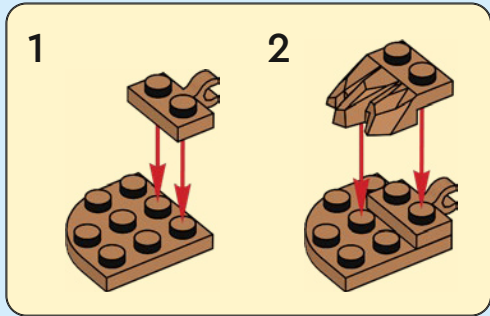

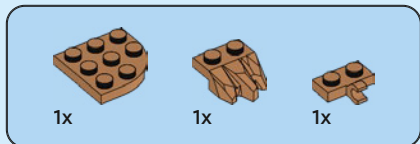

49

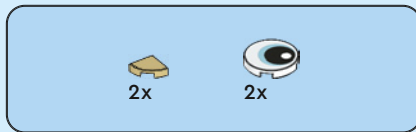
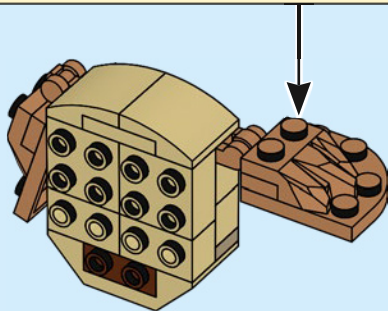
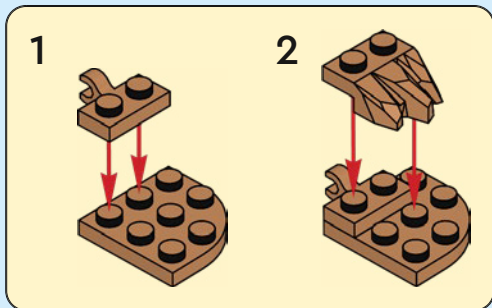

50

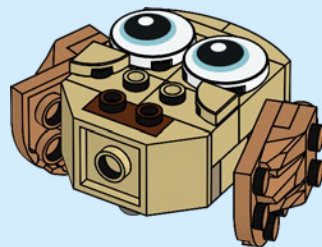



1x

51



2x

52

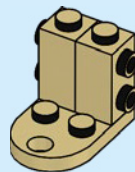

1x

53

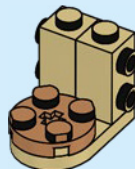



1x



2x

54

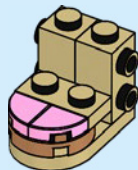

2x

55

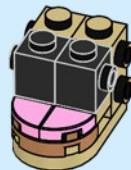





2x



2x

56

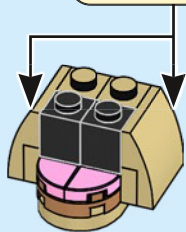
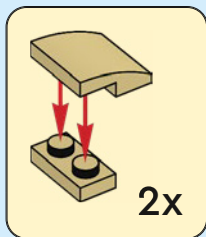

1x



2x

57

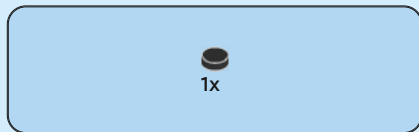
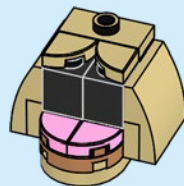

58

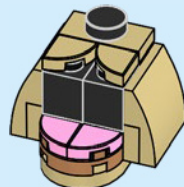

59

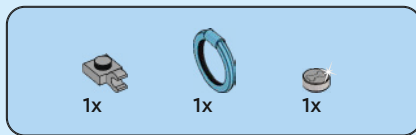
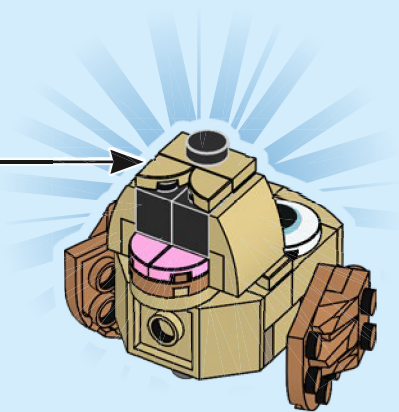

60

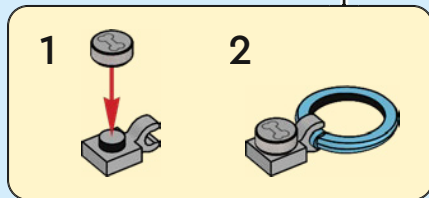
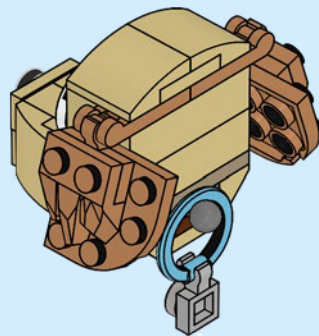



61

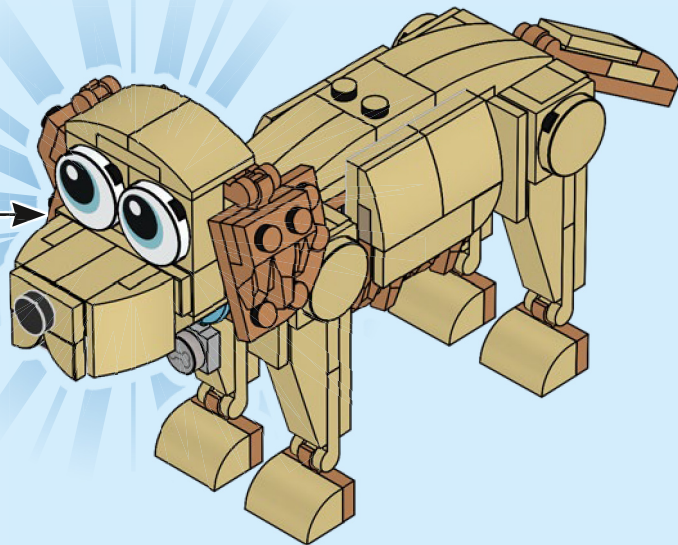

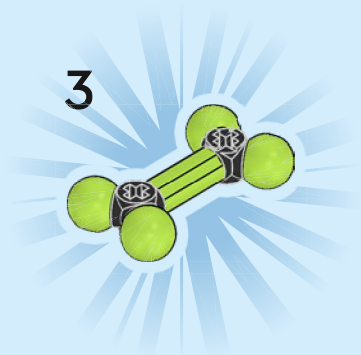
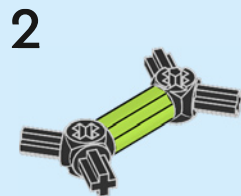
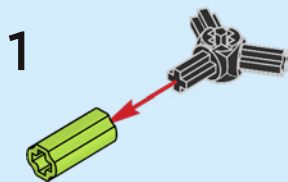
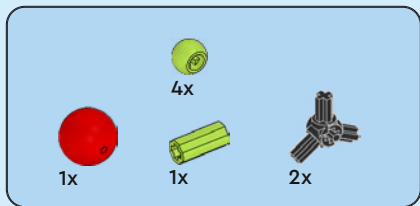

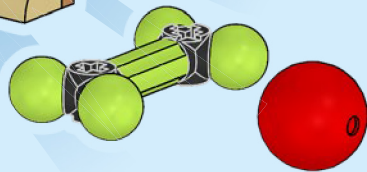
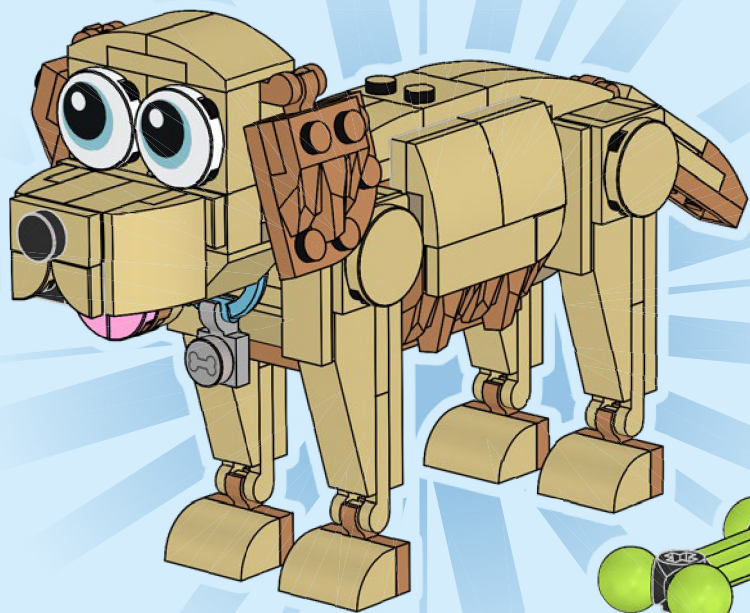

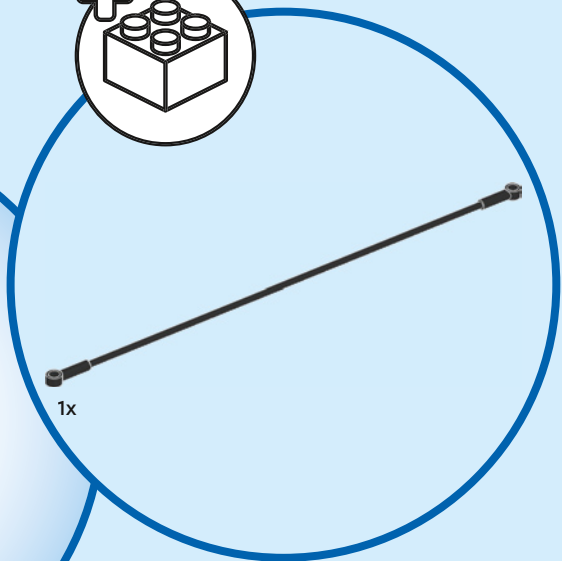
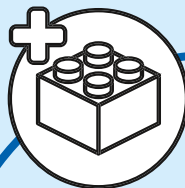

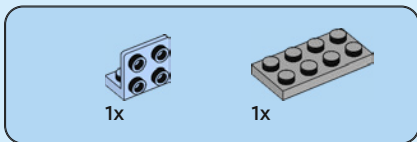
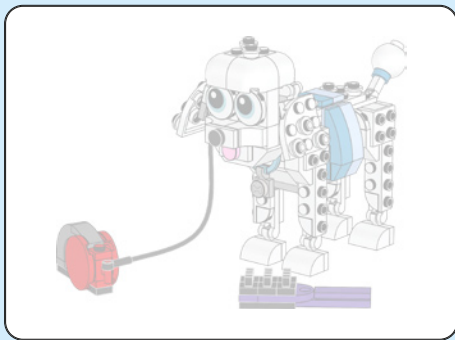

1

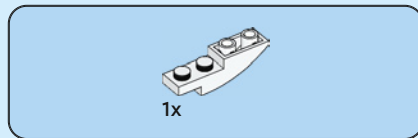
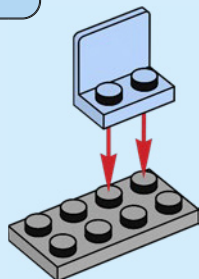

2

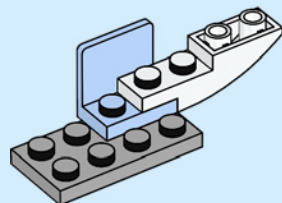



1x

3

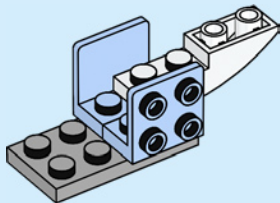

1x

4

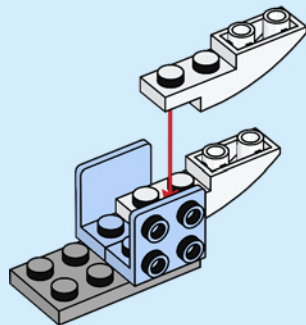





1x

5

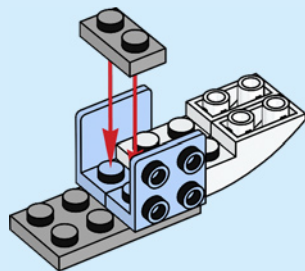

1x



1x

6

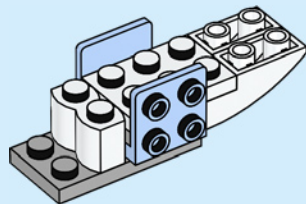



1x

7

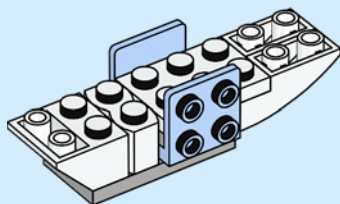

1x

8

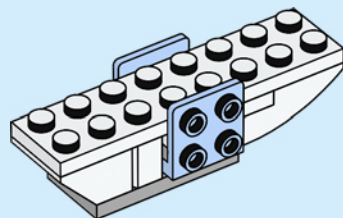



2x



1x

9

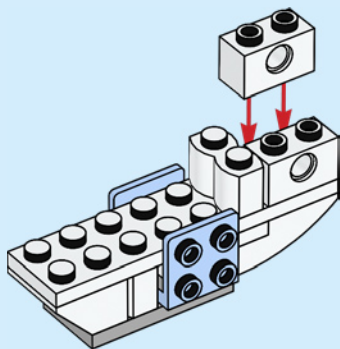

3x

10

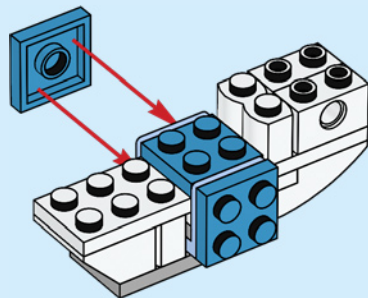



2x

11

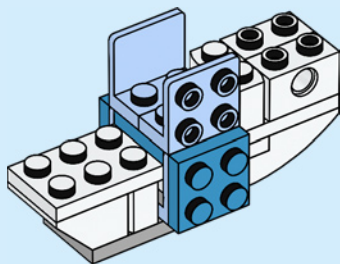

1x



1x

12

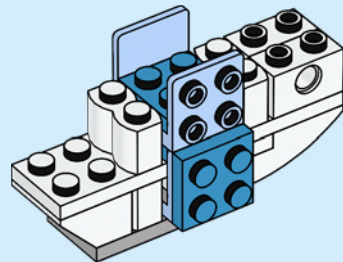



2x

13

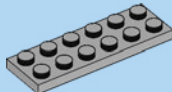
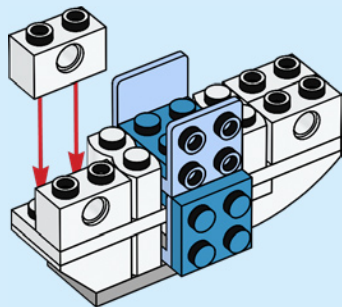

1x



1x



1x

14

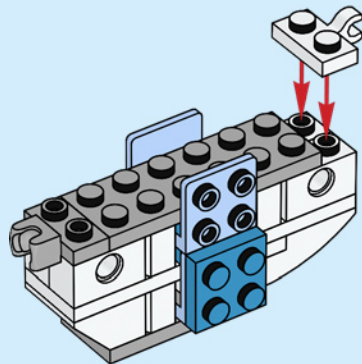

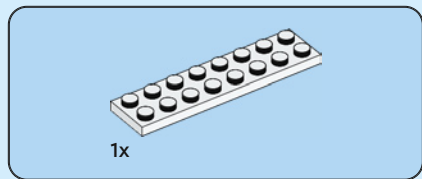

15

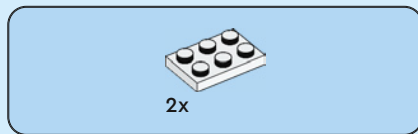
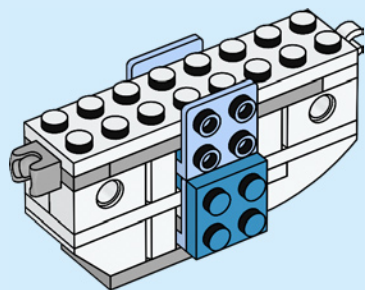

16

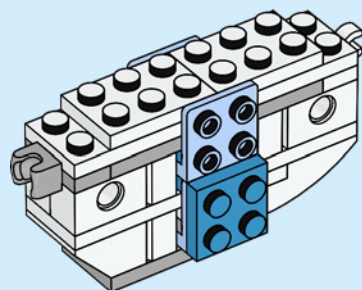

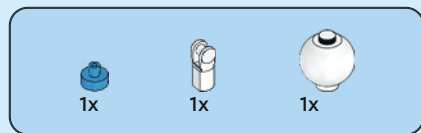

17

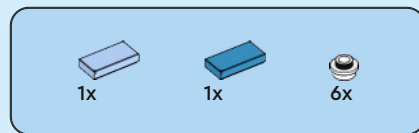
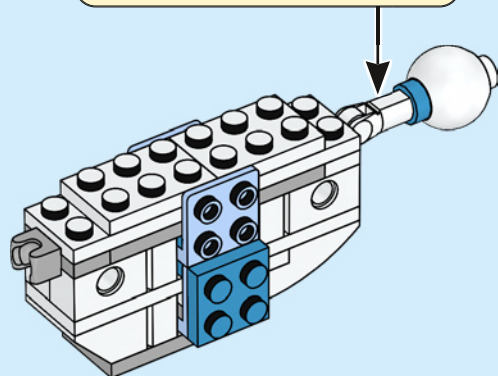
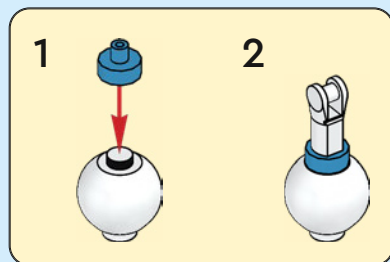

18

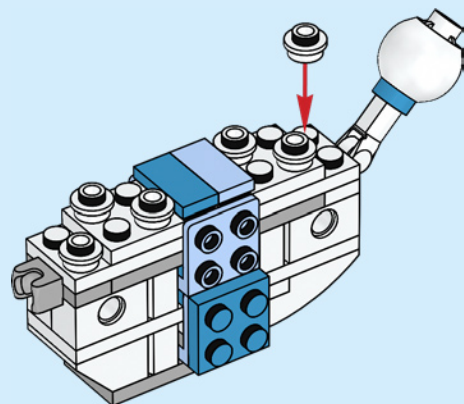

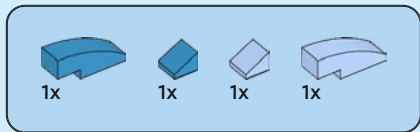

19

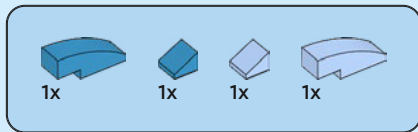
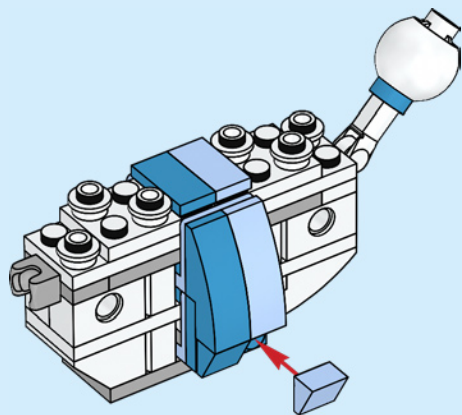

20

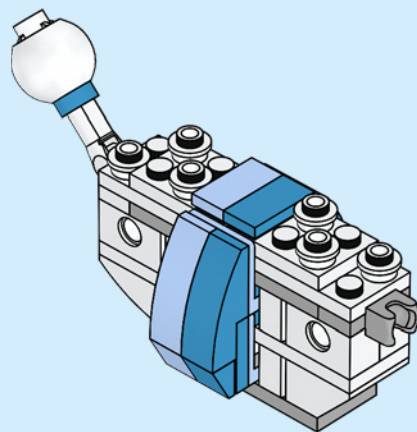





2x



1x



1x

21

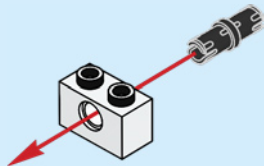

1x

22

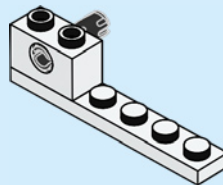

1x

23

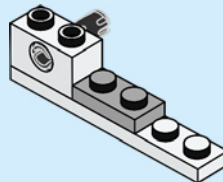



1x



1x

# 24

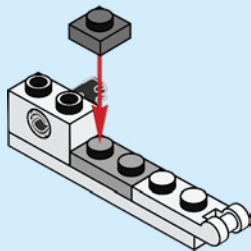

1x



1x

# 25

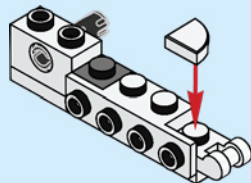

1x

# 26

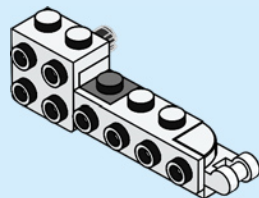



1x



1x

27

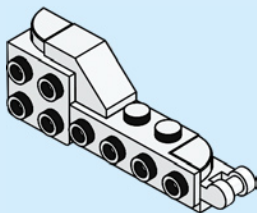

1x



1x

28

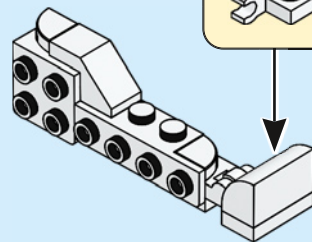
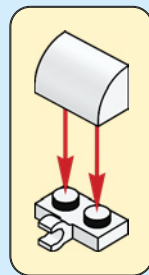

2x

29

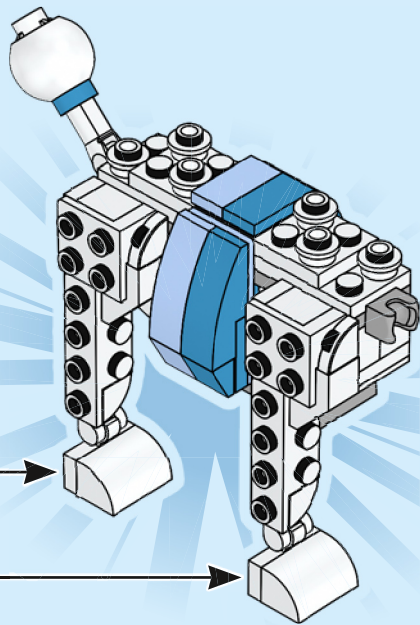

2x



1x



1x

30

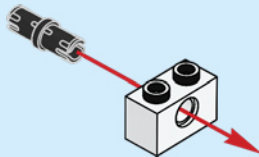



1x

31

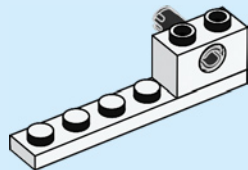

1x

32

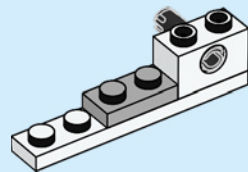

1x



1x

33

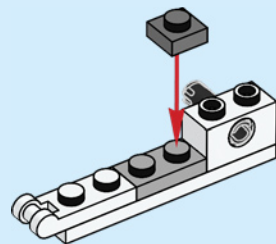

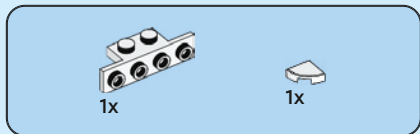

34

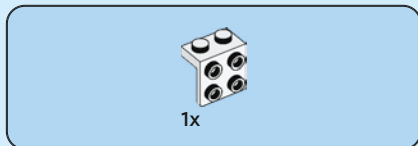
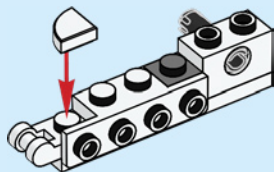

35

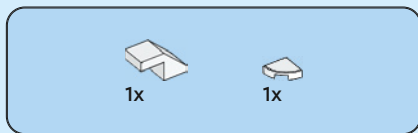
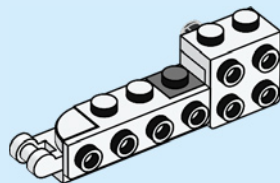

36

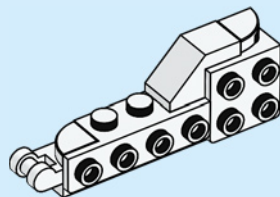



1x



1x

37

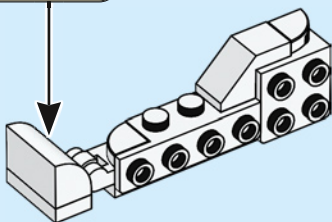
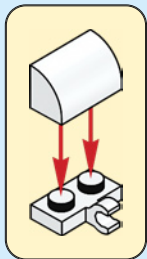

2x

38

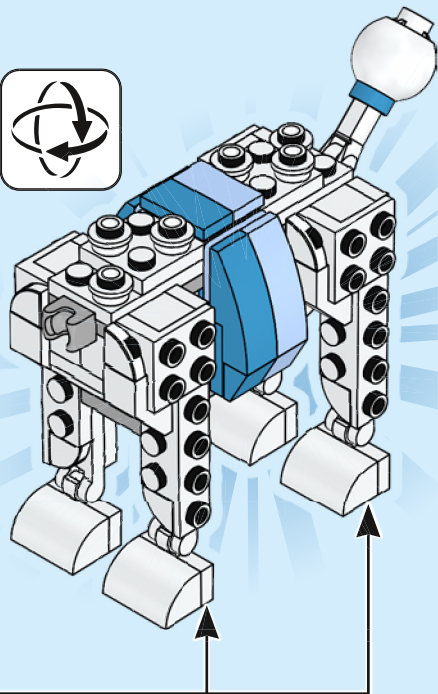

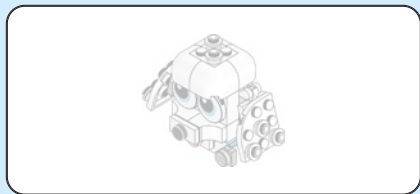

39

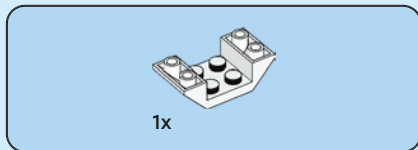
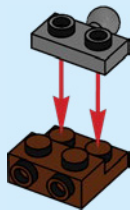

40

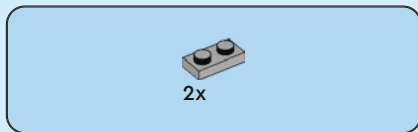

41

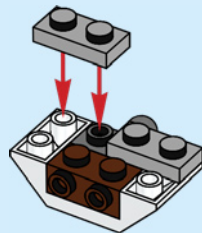



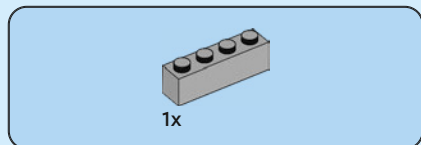

42

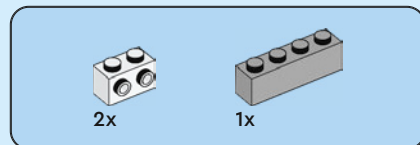
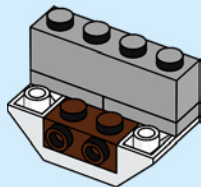

43

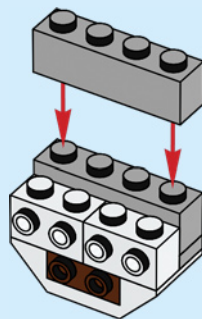



2x

44

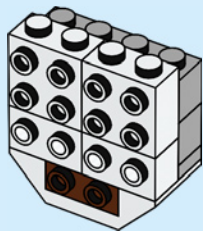

2x

45

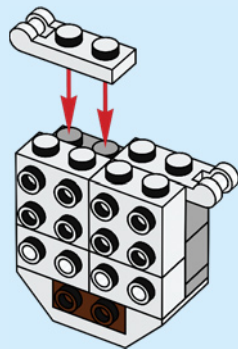



1x

46

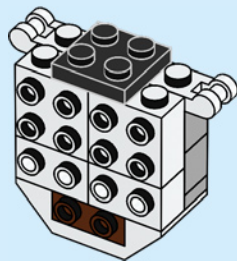

2x

47

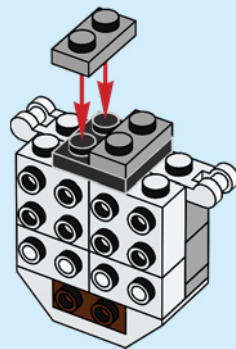



2x

48

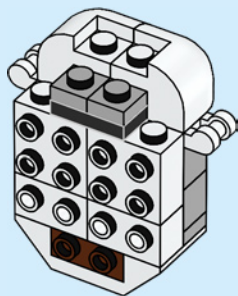

2x

49

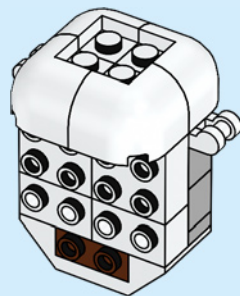



1x

50

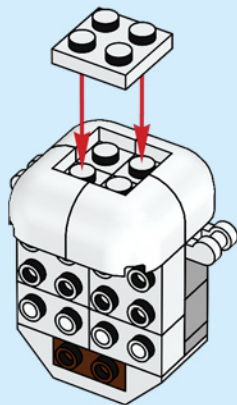

2x

51

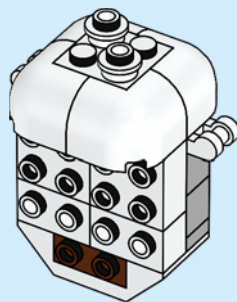

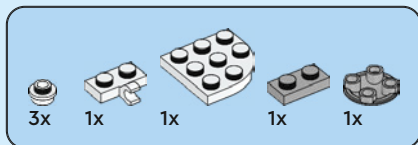

52

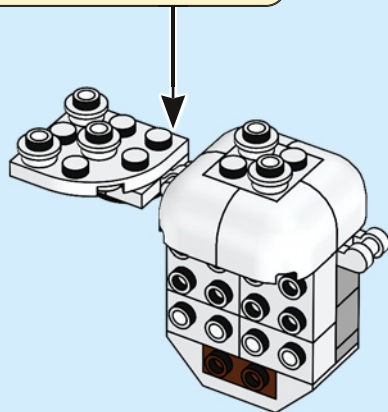
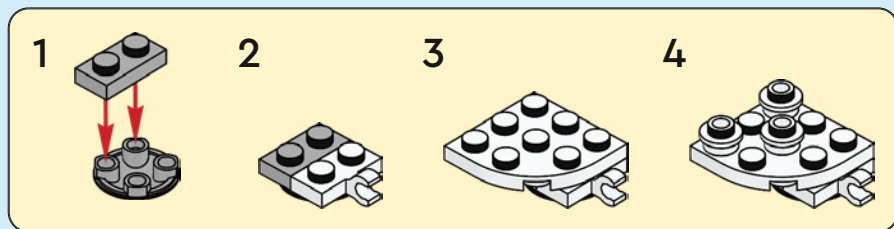

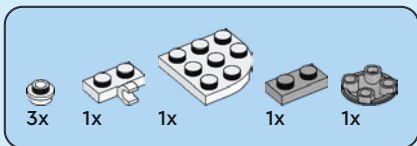

53

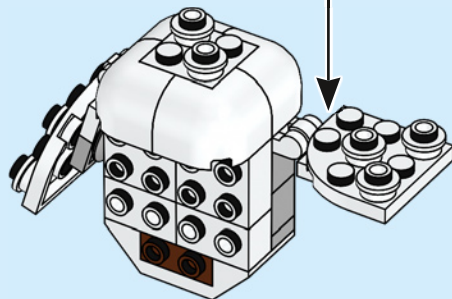
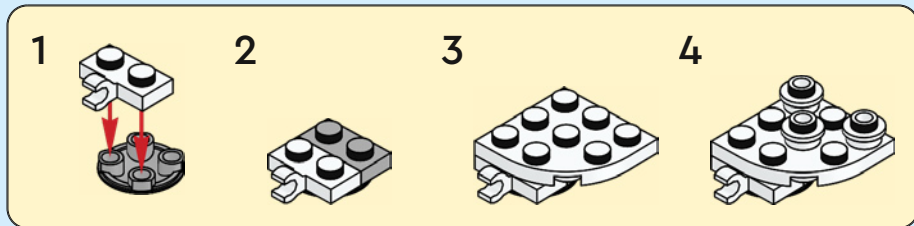



2x

54

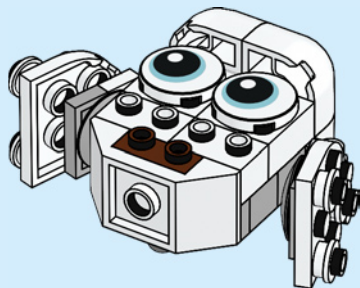

2x

55

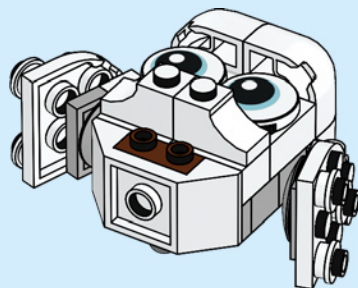





1x



1x

56

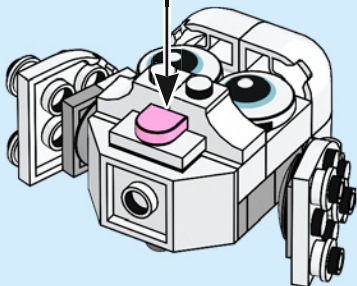
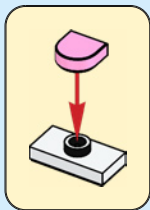

1x



1x

57

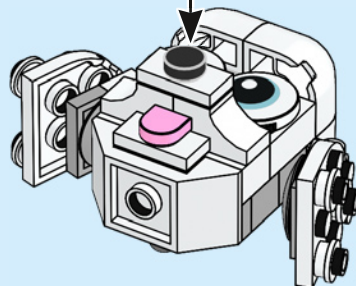
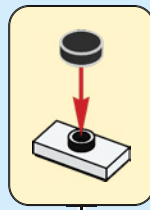

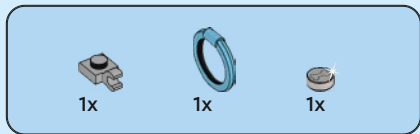

58

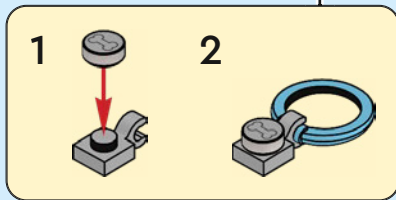
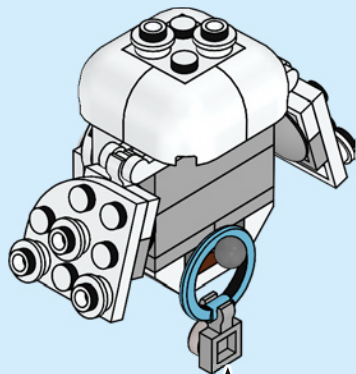

59

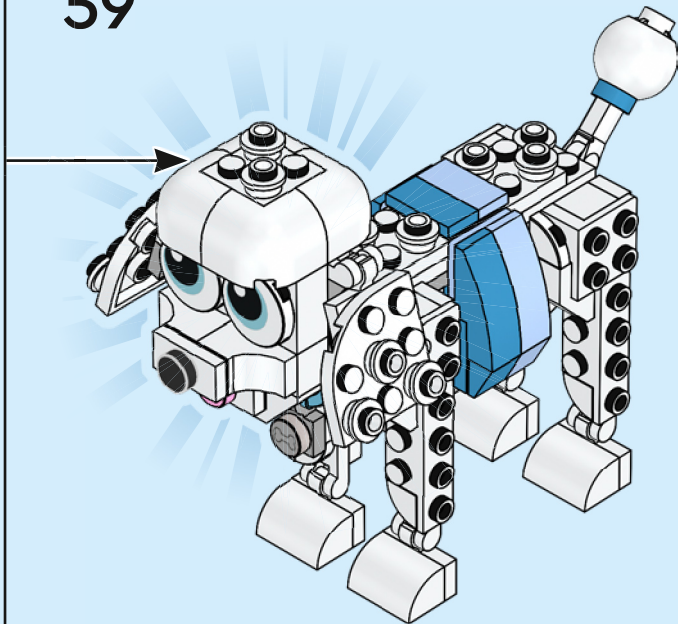

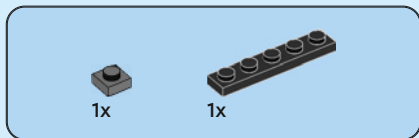
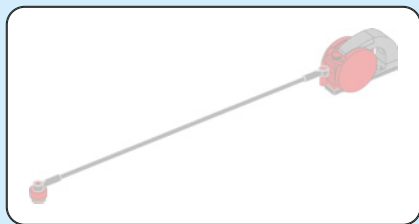

60

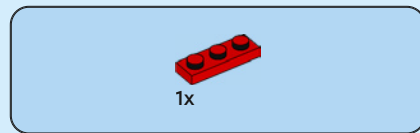
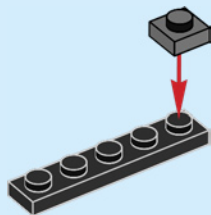

61

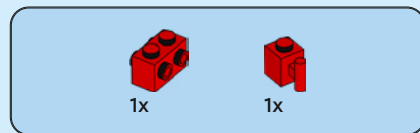
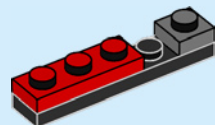

62

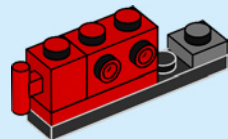



1x

63

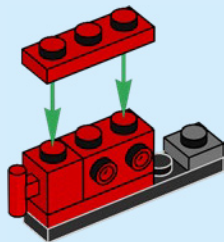

1x

64

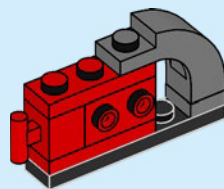



65

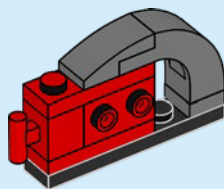

66

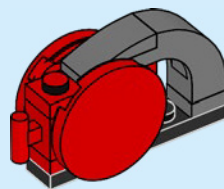

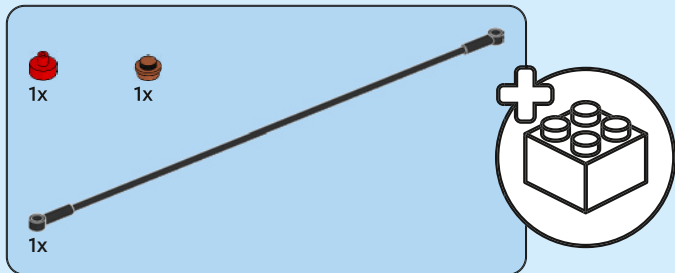

67

1

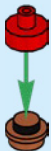

2

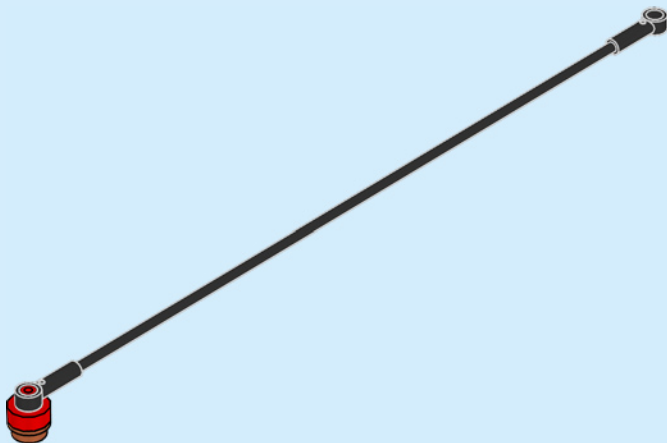

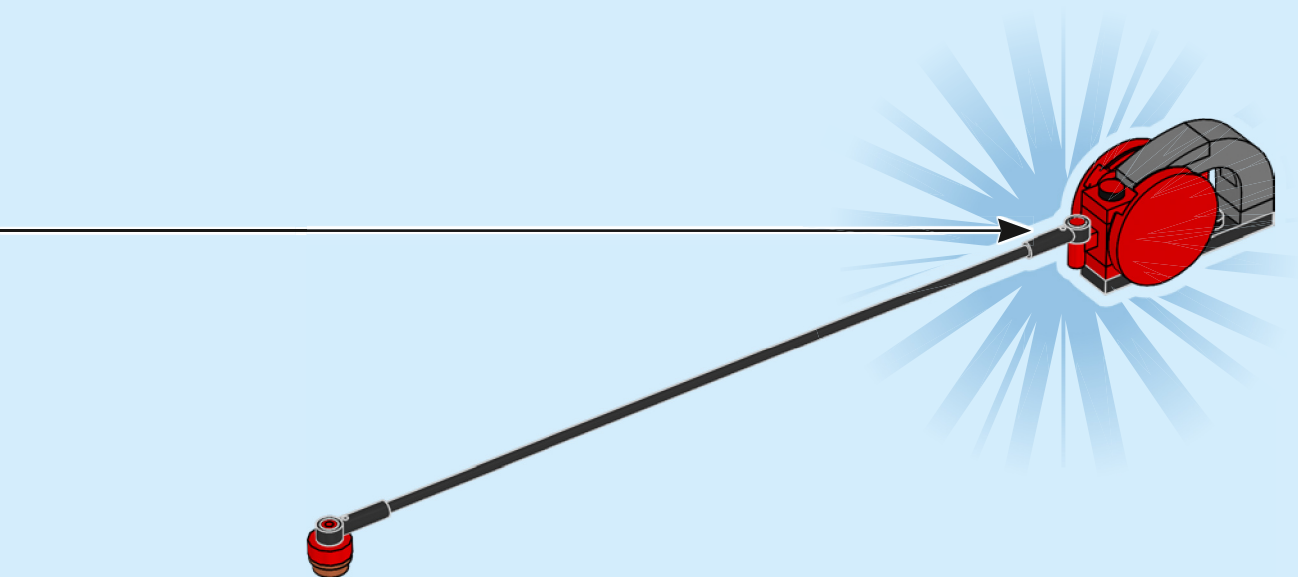

68

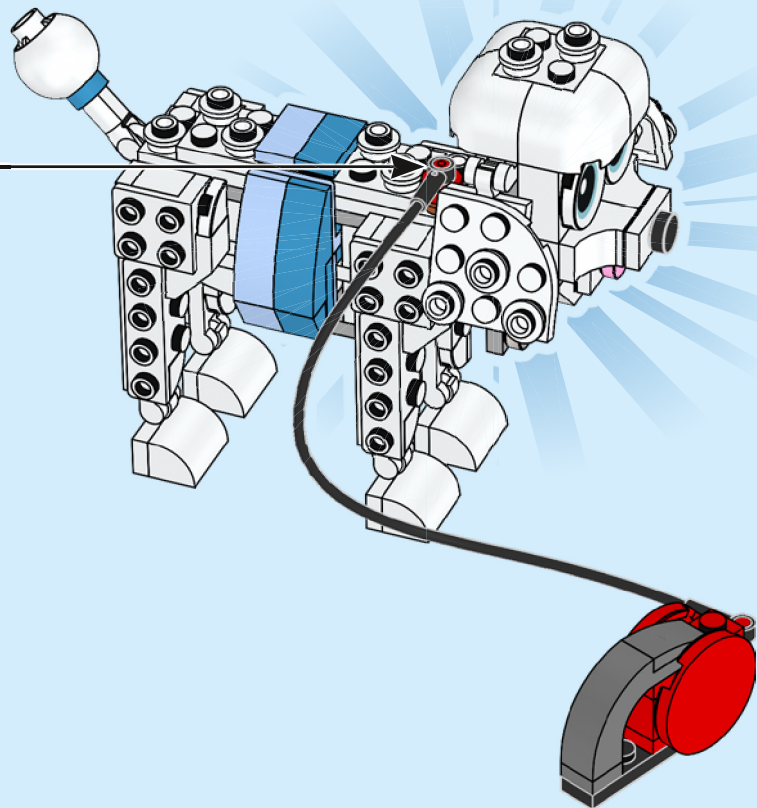



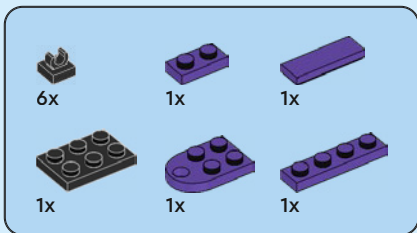

1

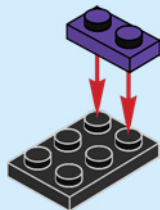

2

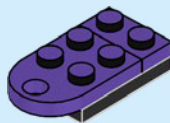

3

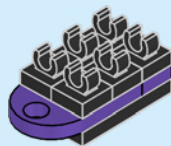

4

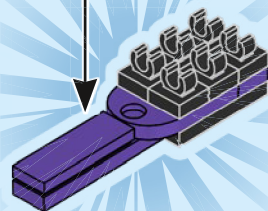
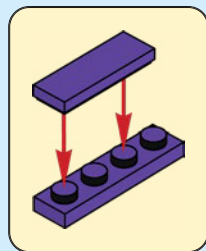

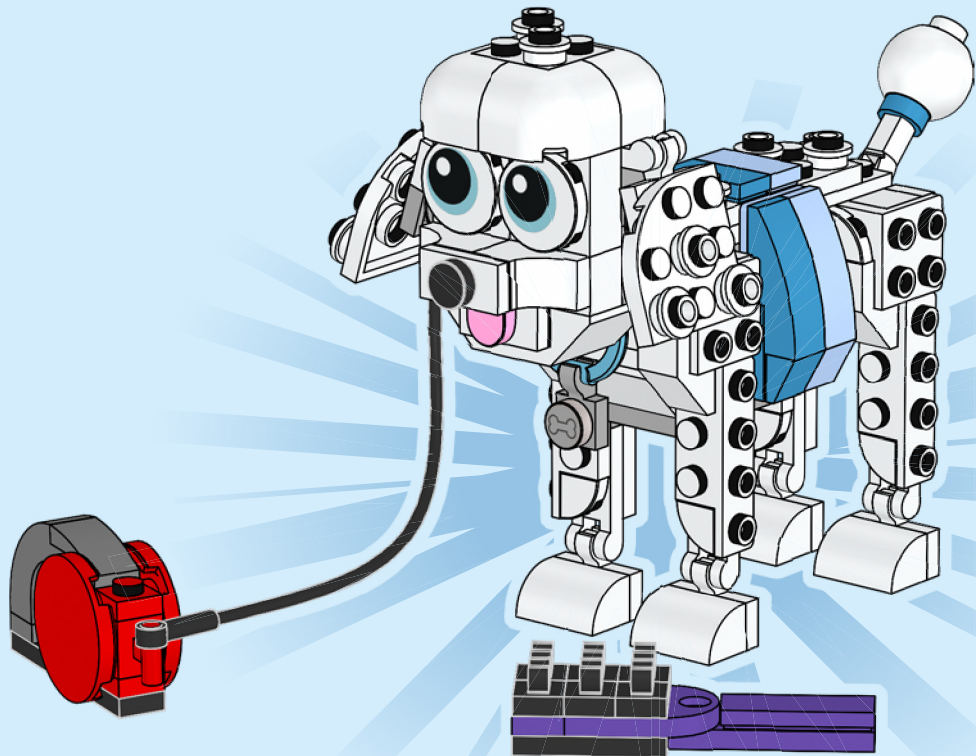

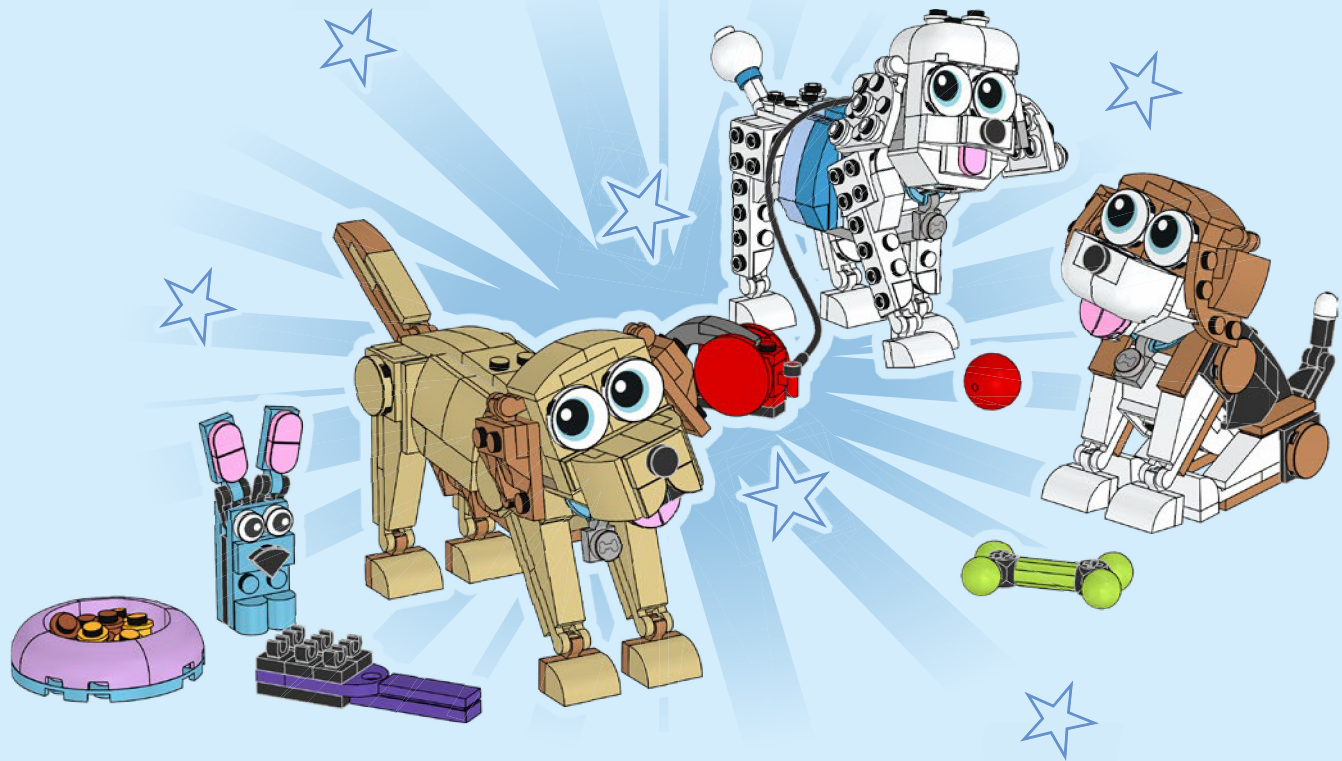

YOU COULD **WIN**



Scan this QR code or go to **LEGO.COM/PRODUCTFEEDBACK** and give us your short feedback about this LEGO® set for a chance to win a cool LEGO prize.

Terms and Conditions apply\*

**DE: Du könntest GEWINNEN.** Es gelten die Teilnahmebedingungen\* **FR: Tu pourrais GAGNER.** Des conditions s'appliquent\* **IT: Potresti VINCERE tu.** Termini e condizioni sono applicabili\* **ES: Puedes GANAR.** Aplican términos y condiciones\* **PT: Poderá GANHAR.** Aplicam-se termos e condições\* **JA: プレゼント付き! 利用規約が適用されます\*** **ZH: 轻松获奖. 条款和条件适用\*** **KO: 상품의 주인이 되어보세요. 소정의 약관이 적용됩니다\*** **RU: Вы можете ВЫИГРАТЬ.** Действуют положения и условия\* **PL: Szansa na WYGRANĄ.** Obowiązują warunki korzystania\* **CS: Máte šanci VYHRÁT.** Platí všeobecné smluvní podmínky\* **SK: Máte šancu VYHRAŤ.** Platia všeobecné zmluvné podmienky\* **HU: TE IS NYERHETSZ.** Felhasználási feltételek érvényesek\* **RO: Ai putea CÂȘTIGA.** Se aplică termeni și condiții\* **BG: Можете да СПЕЧЕЛИТЕ.** Има определени правила и условия\* **LV: Tu vari LAIMĒT.** Ir spēkā noteikumi un nosacījumi.\* **ET: Sul on võimalus VÕITA.** Kehtivad tingimused\* **LT: Jūs galite LAIMĖTI.** Taikomos sąlygos\*

\*LEGO.com/productfeedback-terms