

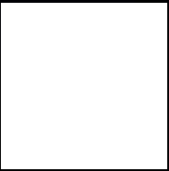

Booklet available in English on
Heft in deutscher Sprache erhältlich auf
Livret disponible en français sur
Libretto disponibile in Italiano su
Folleto disponible en español en
如需中文版手册, 请访问







THE GREAT PYRAMID OF GIZA

◆ The Great Pyramid of Giza is the defining symbol of ancient Egypt and one of the most iconic architectural structures in the world. Much of the story of how and why these 2.3 million blocks of stone were brought together remains a mystery, even after 140 years of modern archaeological excavations. Believed to have been built as a tomb for Khufu, a pharaoh of the Fourth Dynasty, the 146.5 m (481 ft.) tall pyramid took 27 years to construct and would remain the tallest man-made structure in the world for over 3,800 years. This LEGO® Architecture set is a celebration of this extraordinary feat of engineering and architecture and attempts to capture a moment in time when ancient Egyptian civilization was at its pinnacle and the Great Pyramid was nearing completion.



FROM THE DESIGN TEAM

▲ Ancient Egypt has always been a fascination of mine, so having the chance to travel back and imagine the Great Pyramid as it might have been in its own time was a pleasure. It was particularly interesting to recreate both a completed Pyramid and another below that is still under construction. It's an unusual feature for a LEGO® Architecture model to be able to show how a structure may have been built. This part of the model can also be lifted away from the main model and displayed separately if you wish.

ANDERSON WARD GRUB
Senior Designer at the LEGO Group

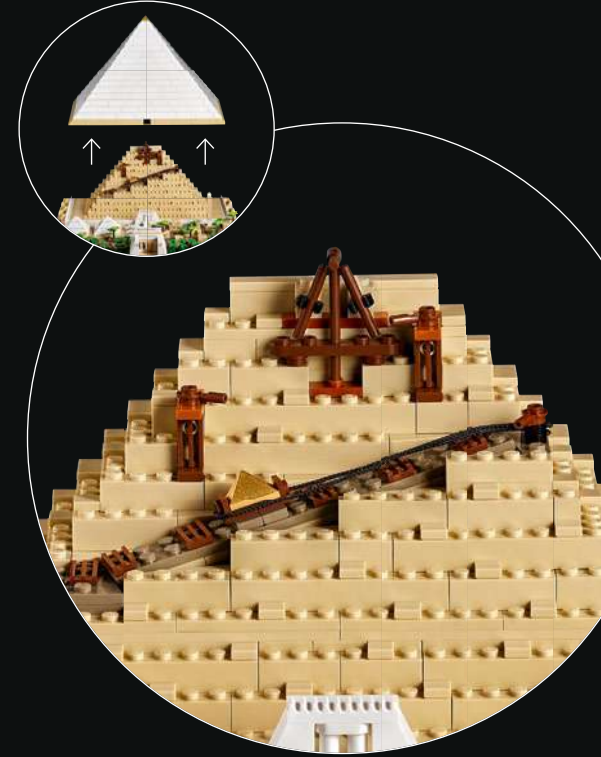

HOW THE PYRAMID WAS CONSTRUCTED

There are many theories on how the pyramid was constructed. Remove the outer shell to see ramps, ropes and sledges being used to move the massive stone blocks, plus a crane to lift smaller materials.



FEATURES OF THE PYRAMID



INSIDE

A sloping corridor descends through the Pyramid's interior and branches off to the Queen's Chamber and Grand Gallery. A narrow passageway at the end of the Gallery gives access to the King's Chamber. Two air shafts lead away from the chamber, perhaps to allow the Pharaoh's ka (spirit) to travel to the afterlife.



THE CAPSTONE

It is believed the Great Pyramid had a capstone covered in gold to make it shine brilliantly in the sun.



OUTER CASING

The outer shell of the pyramid was made from white limestone, polished smooth.



THE SMALLER PYRAMIDS

Here are two of the four smaller pyramids, which likely were tombs for Khufu's family. Three remain intact today.



THE OBELISK

Obelisks were likely invented about 150 years after the Great Pyramid was built. One is included here to acknowledge their broader importance in ancient Egypt.



THE SPHINXES

Carvings of Sphinxes may have lined the main approach to the Pyramid.



WORKERS' VILLAGE

Whole villages would be built to house the artisans and labourers working on the Pyramid.



THE HIEROGLYPH NAME PLATE

These hieroglyphs show the Great Pyramid's ancient name, 'Khufu's Horizon'.



THE VALLEY TEMPLE

The Valley Temple on the edge of the Nile was where the body of the Pharaoh was received before burial in the Pyramid.



THE FELUCCA

These ancient boats, which typically had a singular triangular sail, ferried people and goods up and down the Nile.

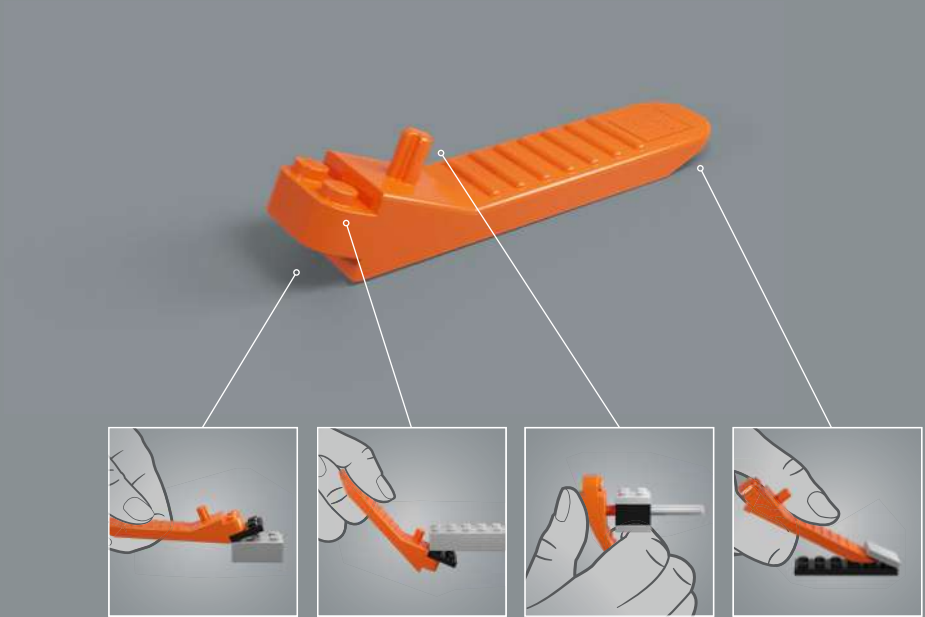



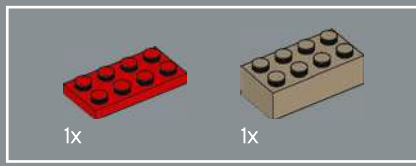

1

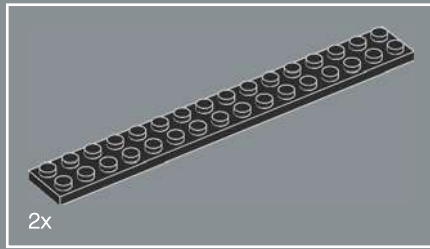
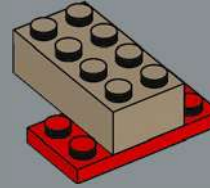

2

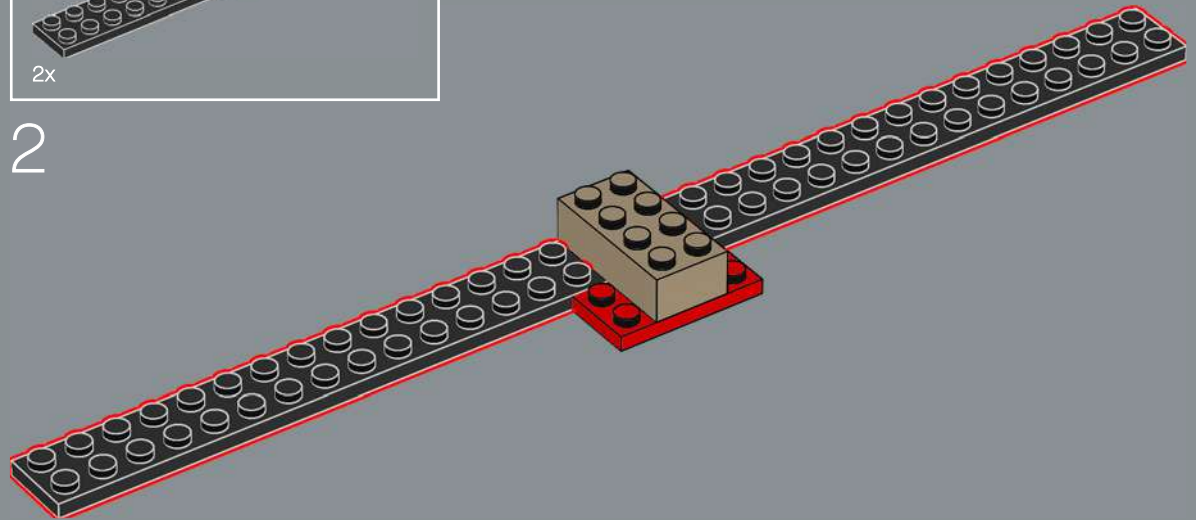

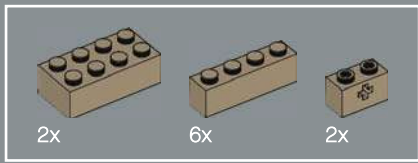

3

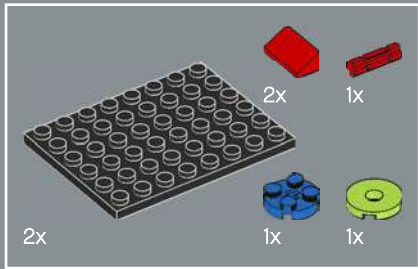
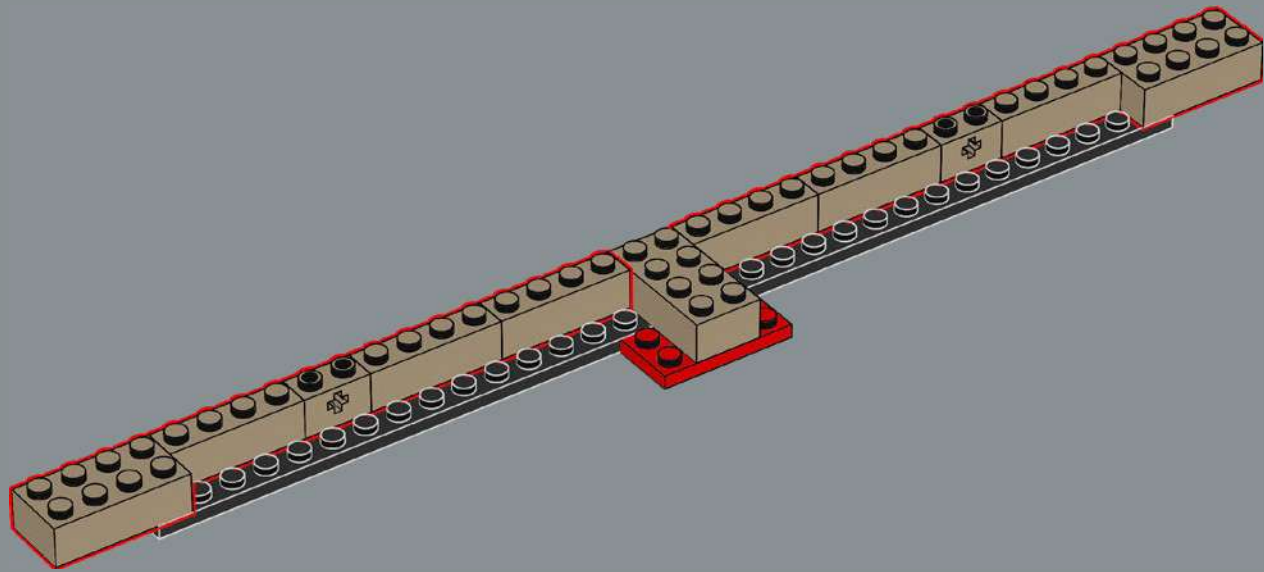

4

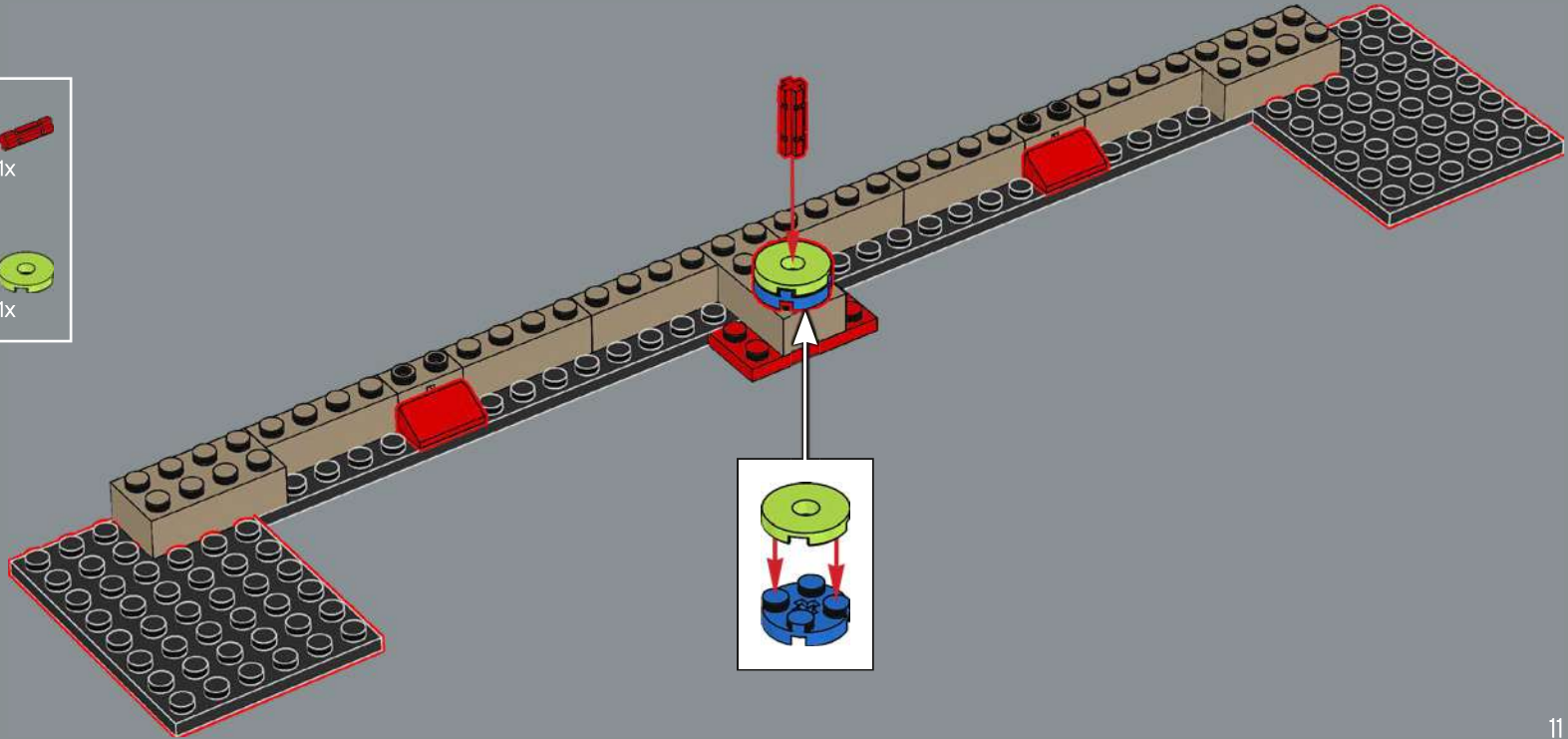

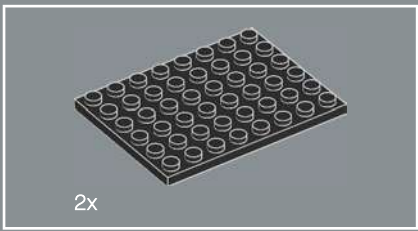

6

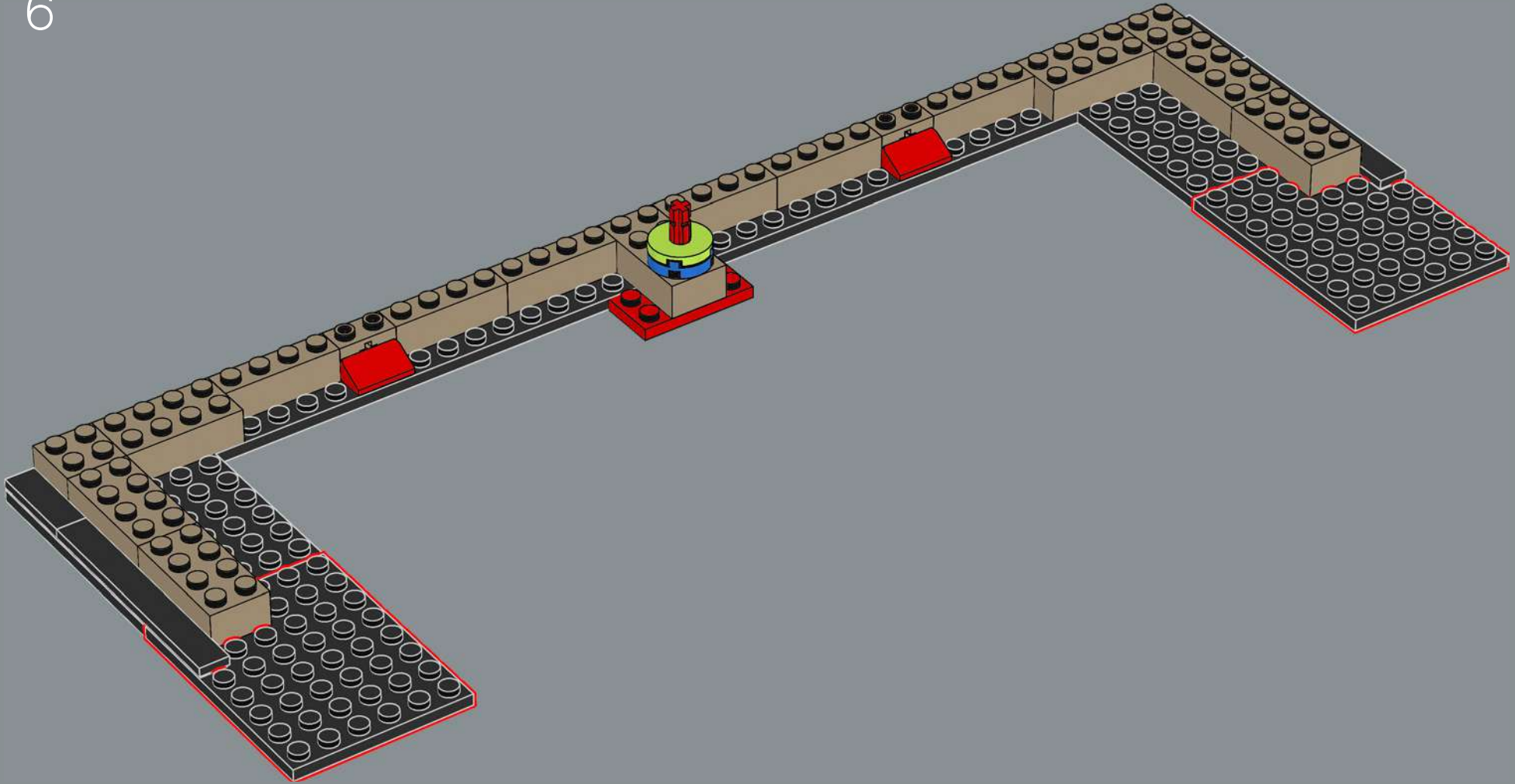

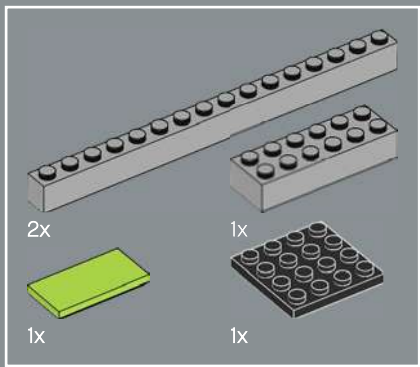

7

1

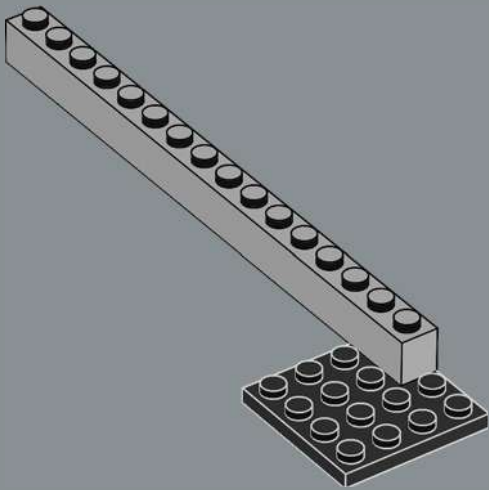

2

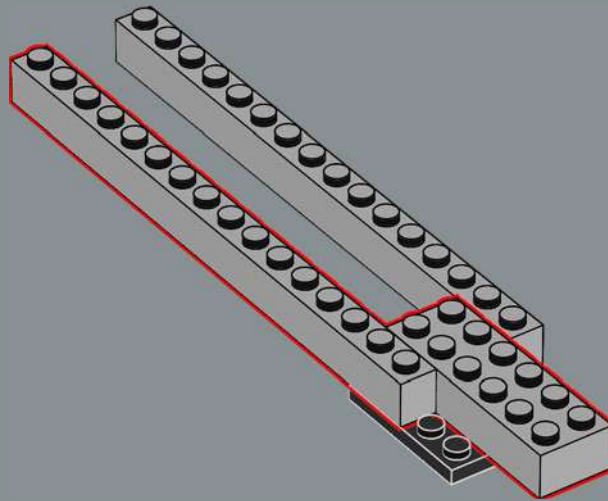

3

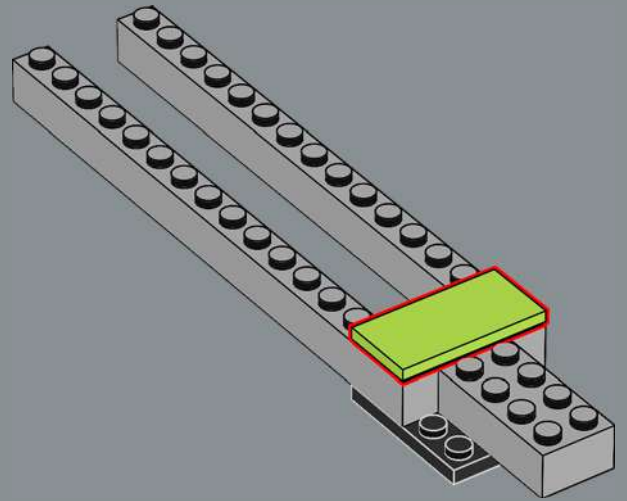

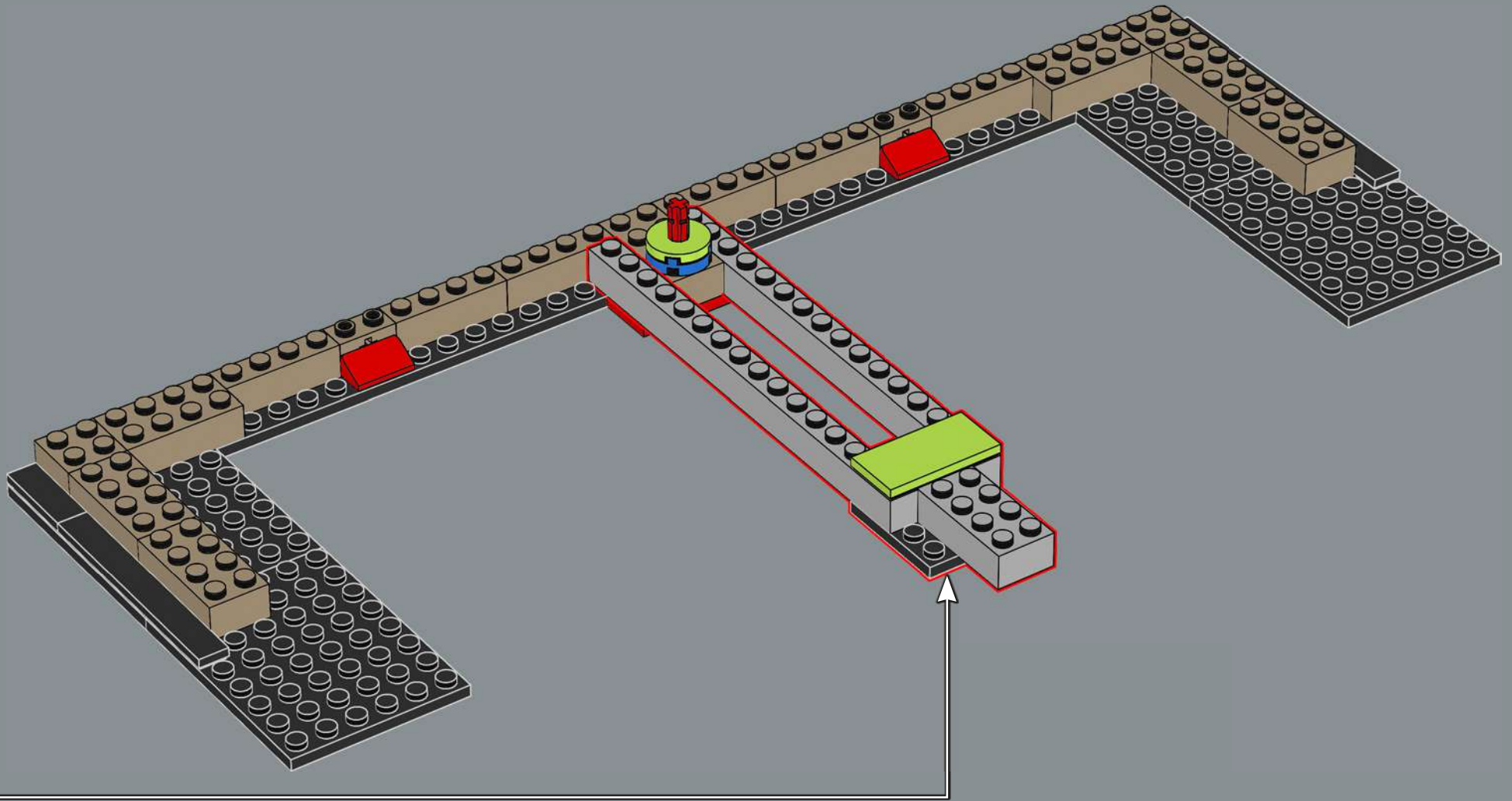

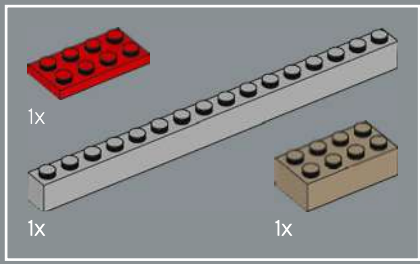

8

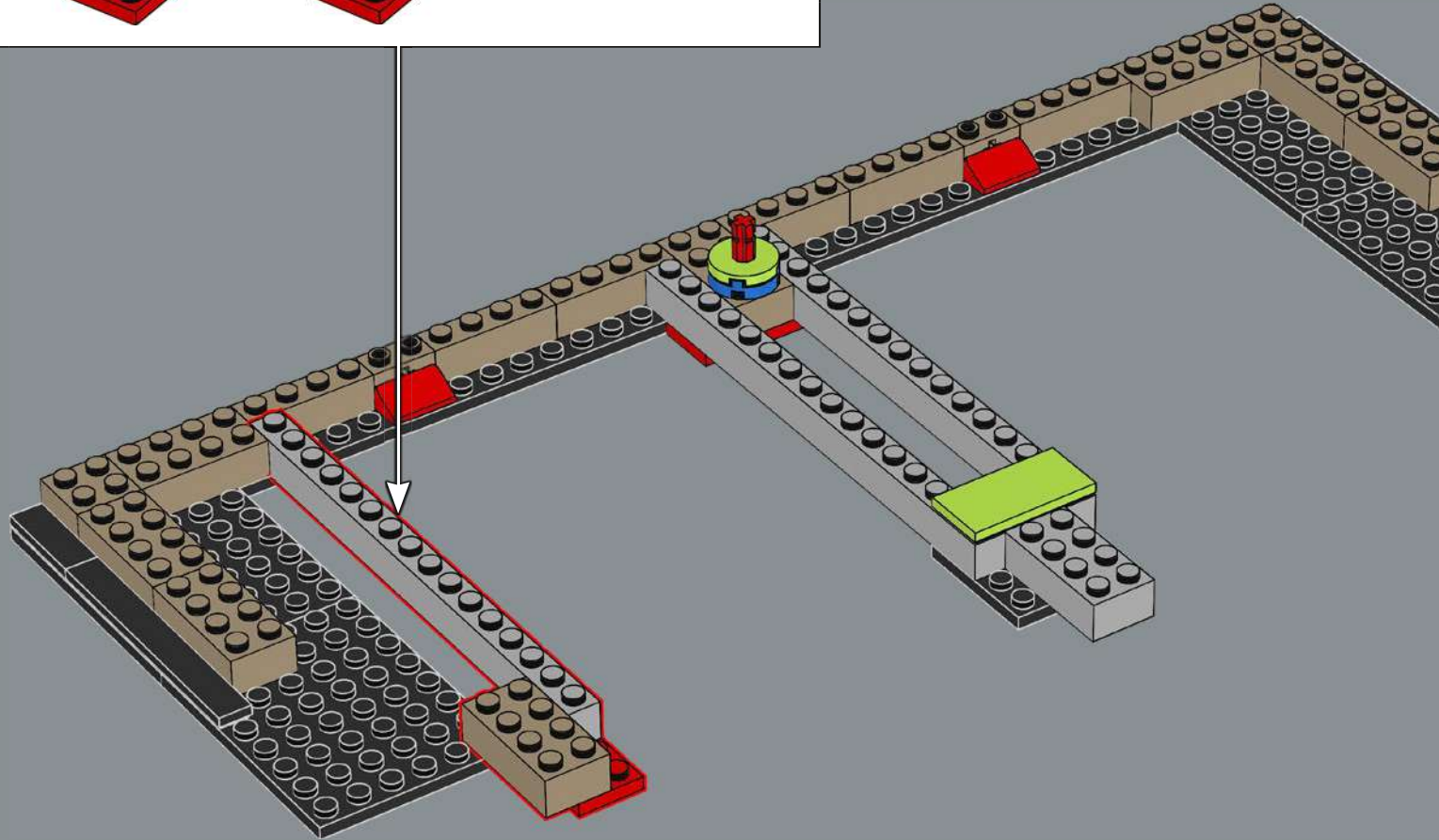
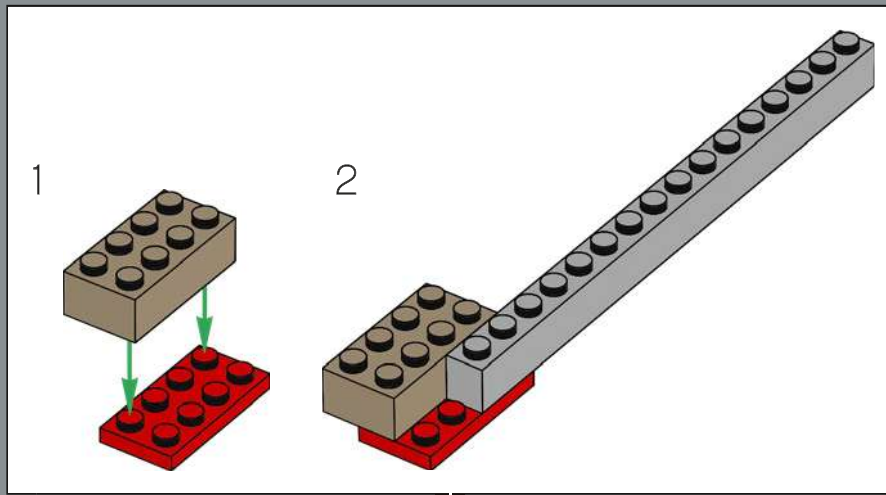

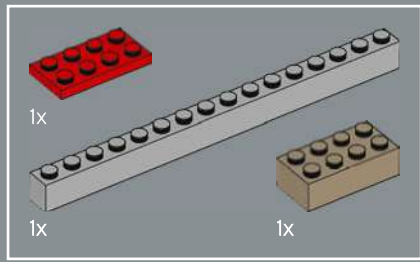

9

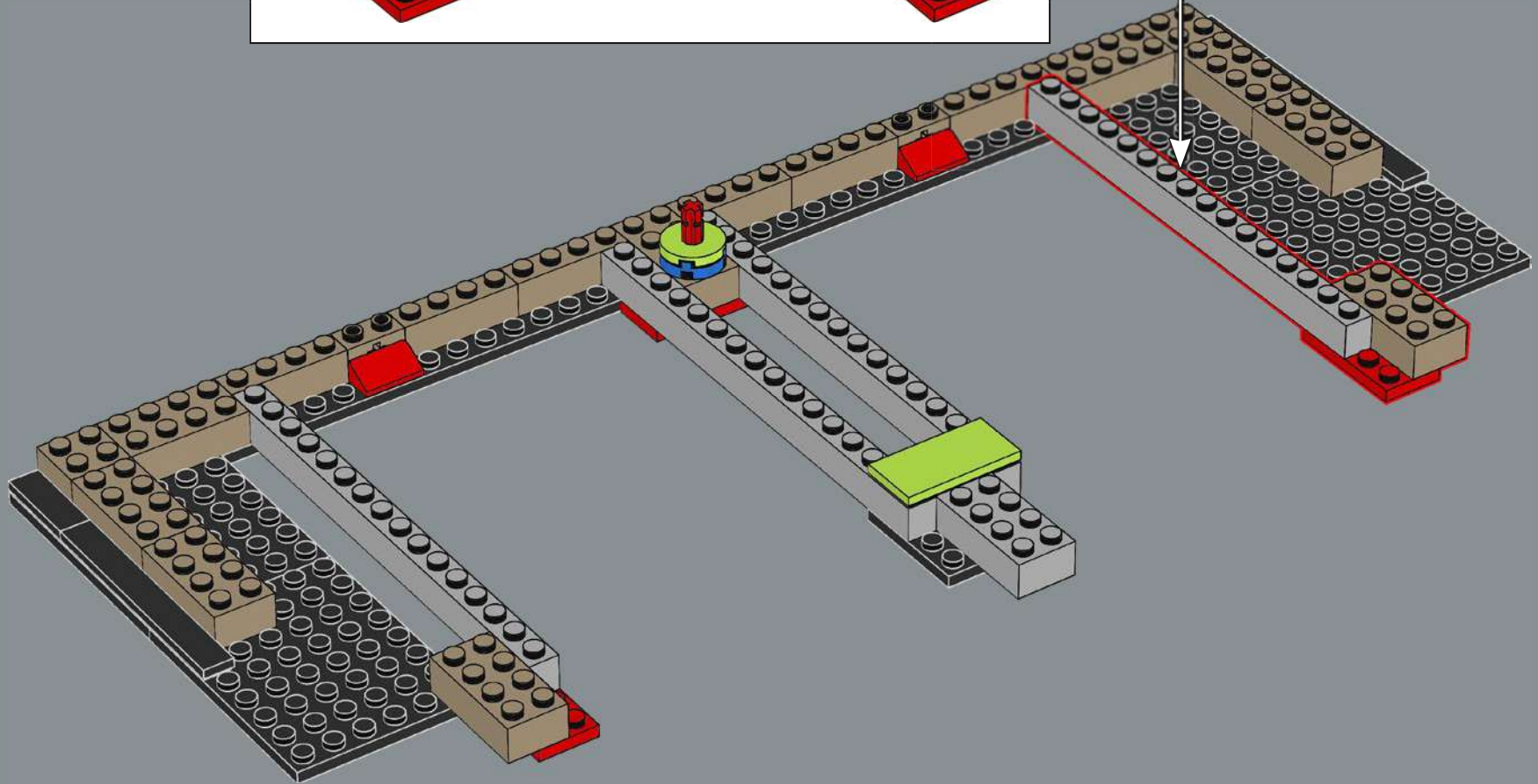
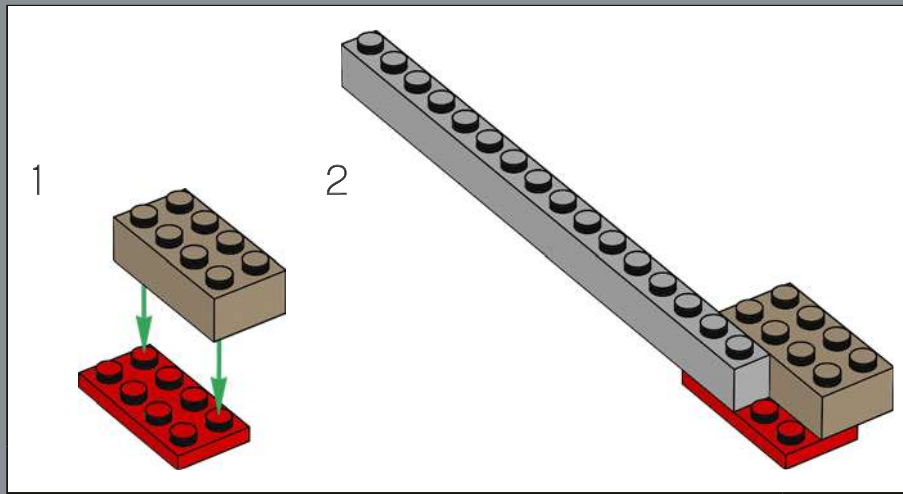

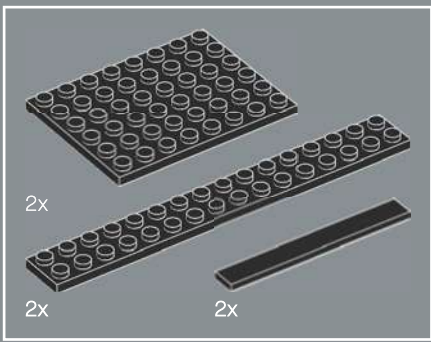

10

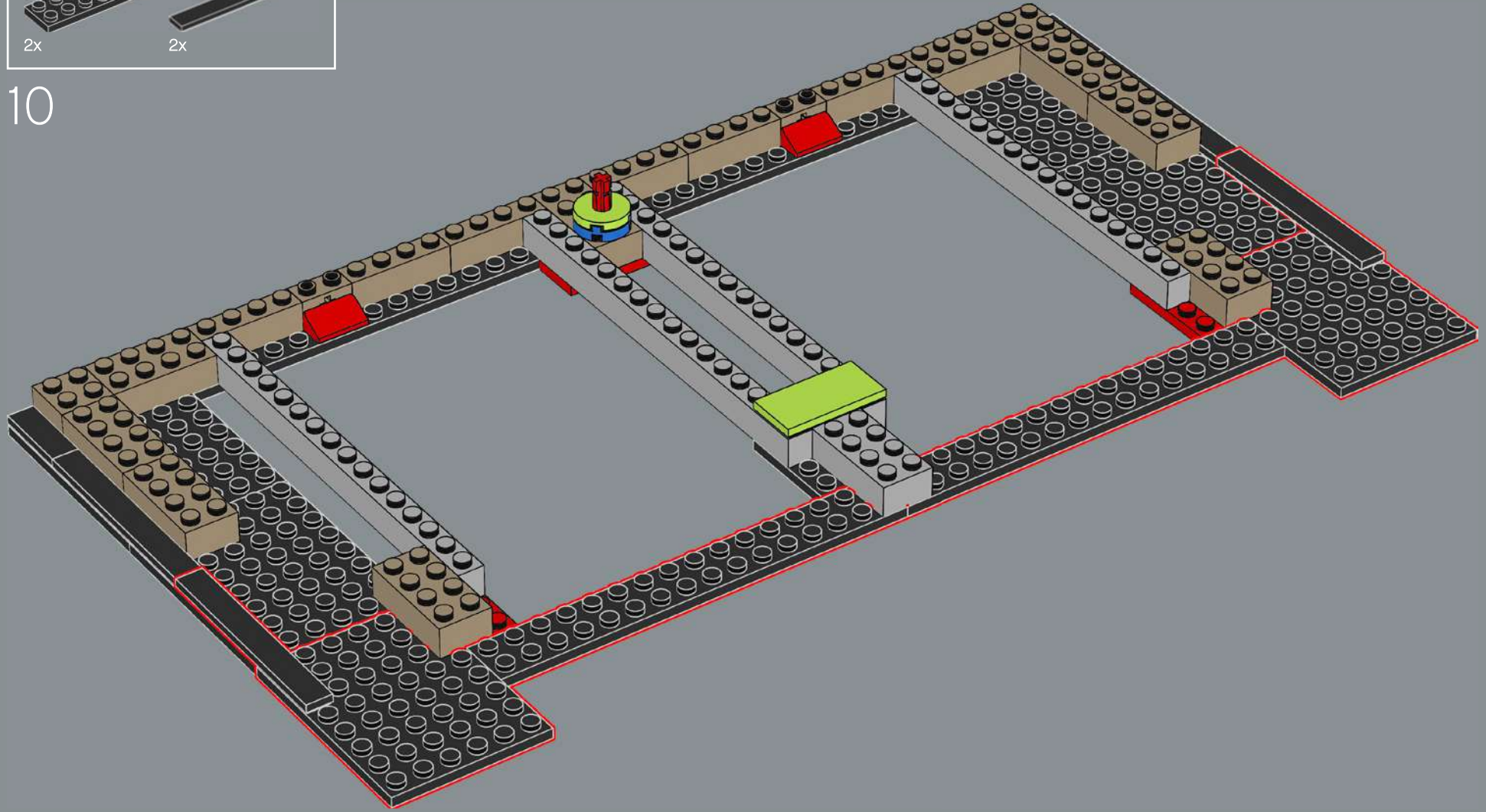

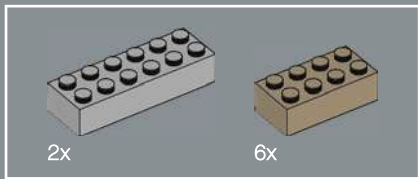

11

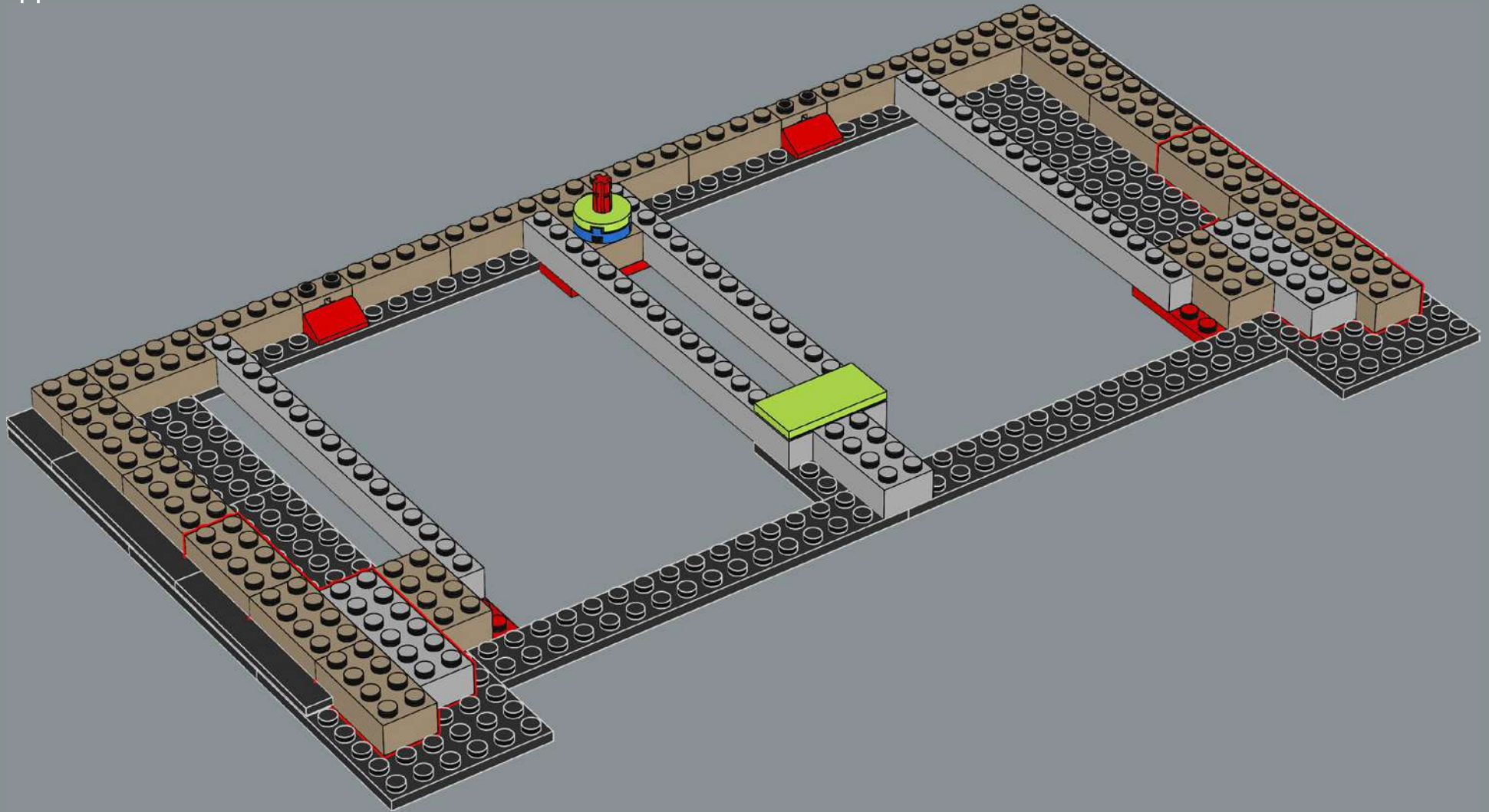

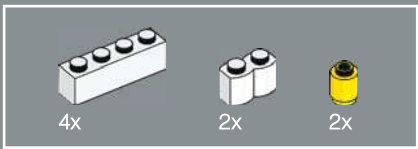

12

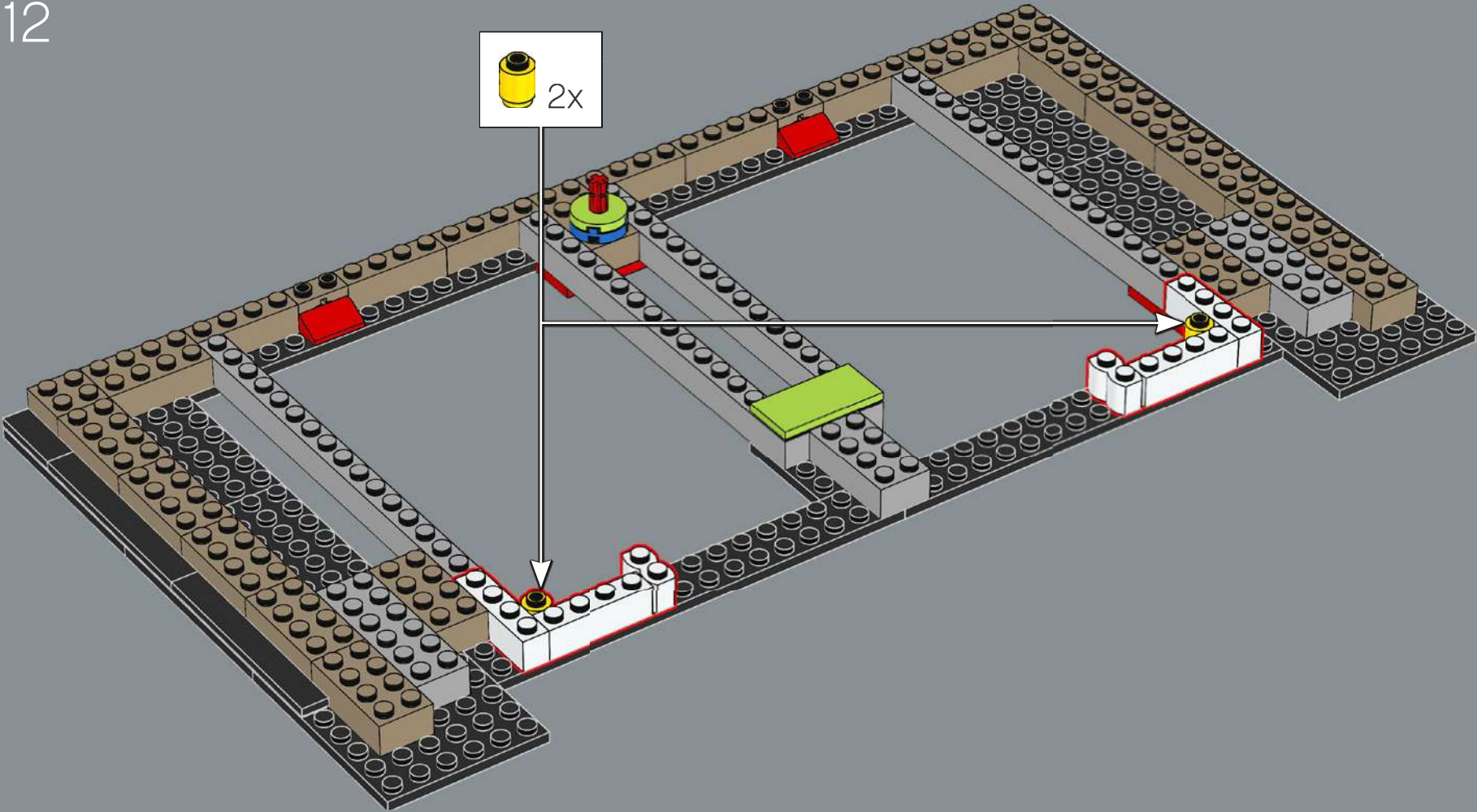

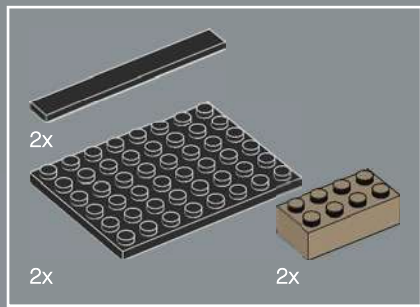

13

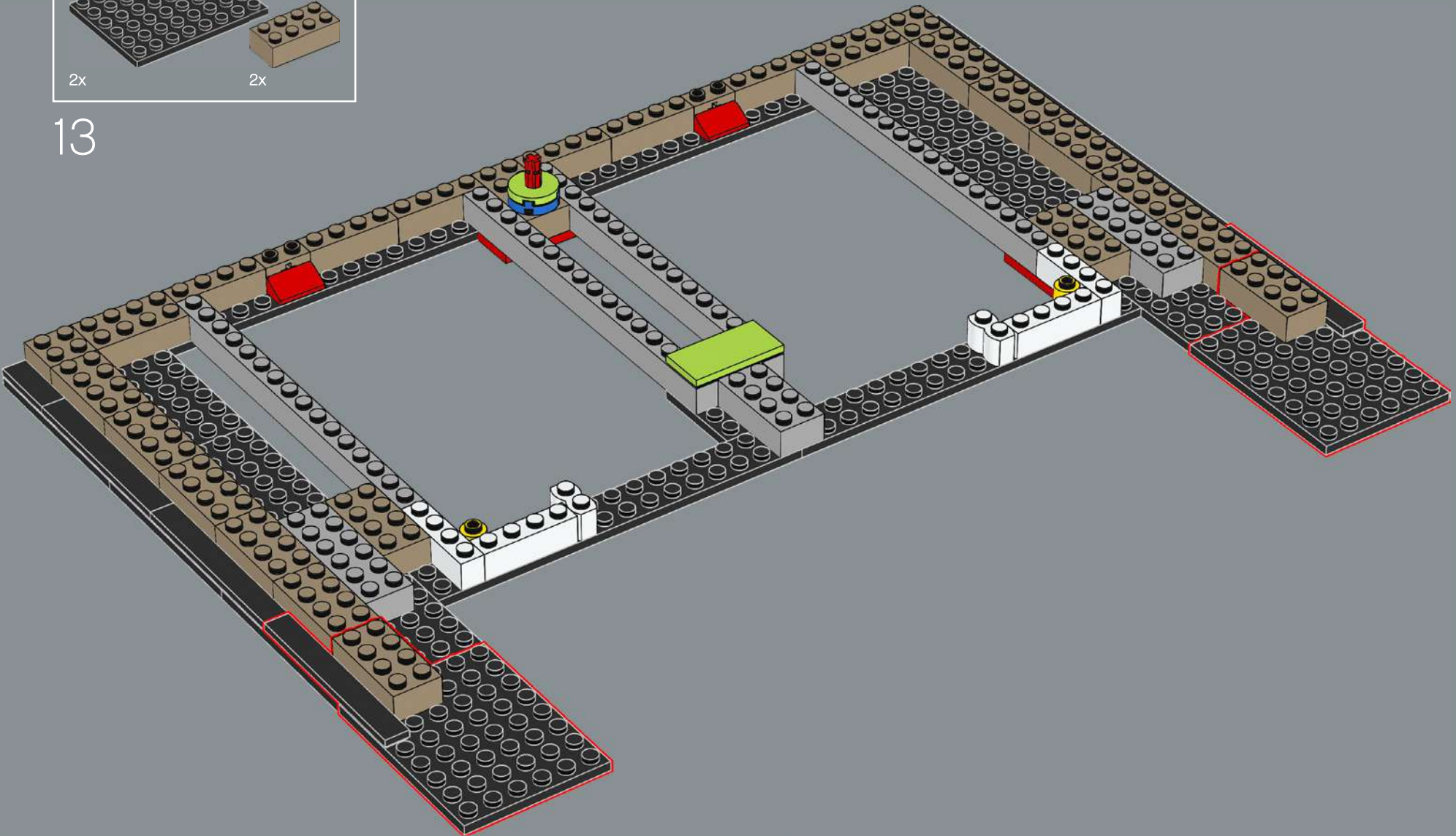

14

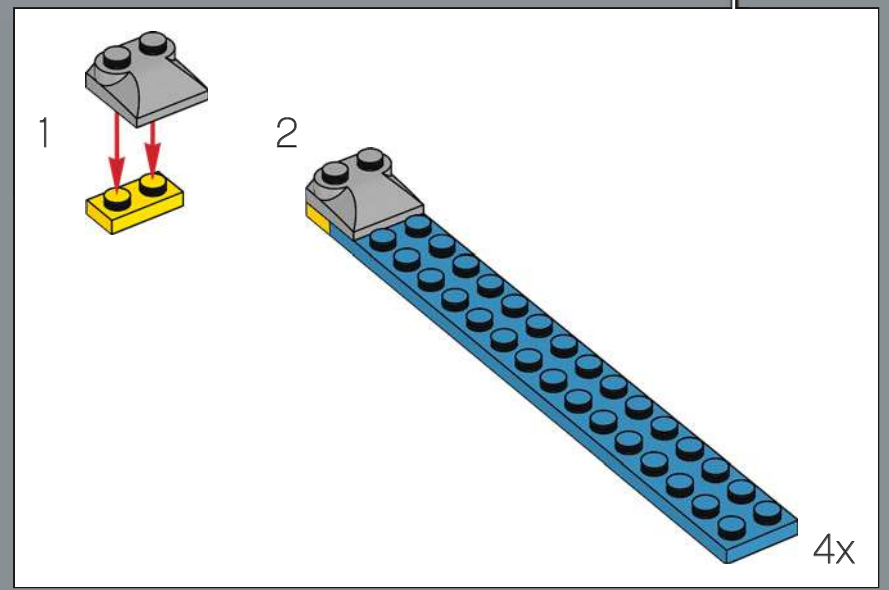
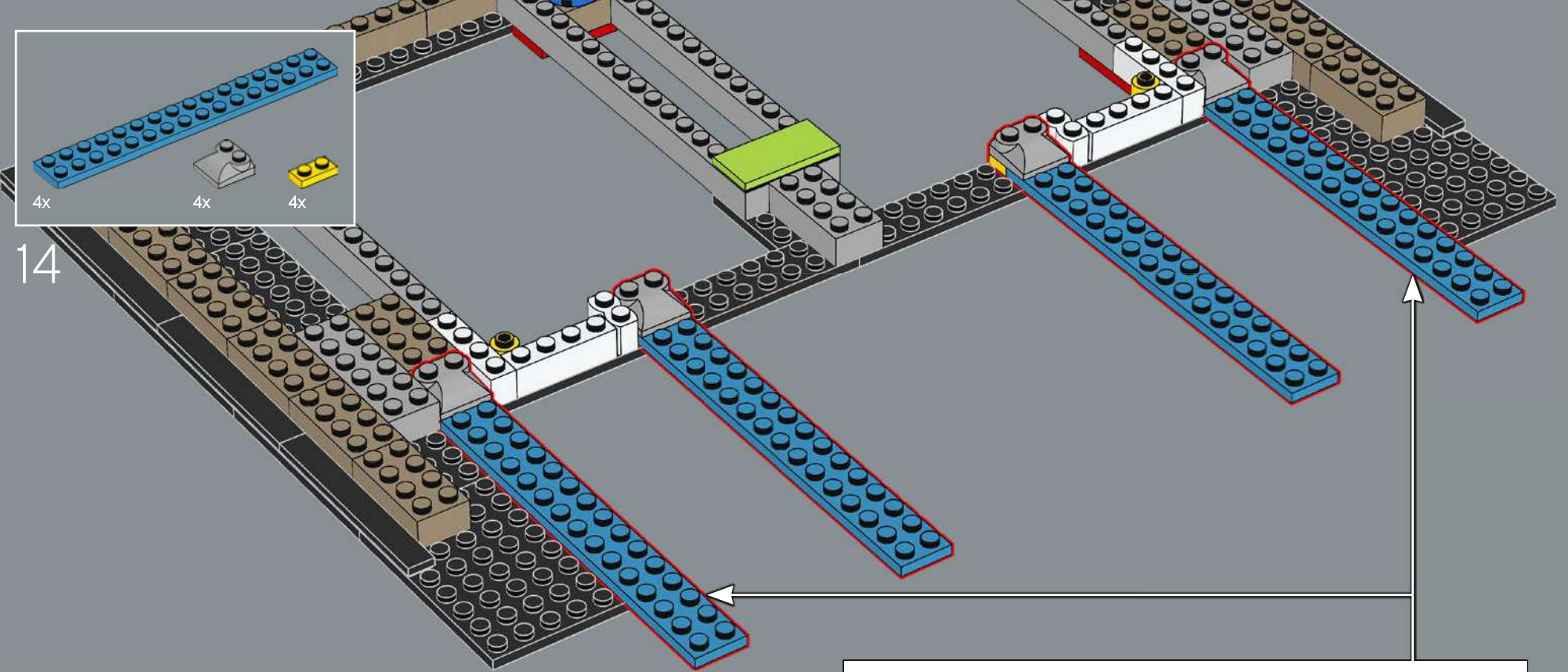
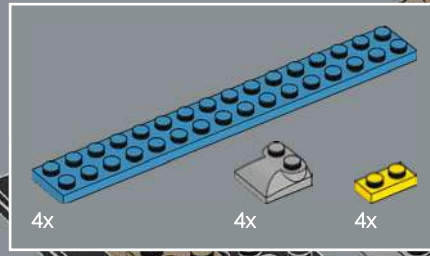

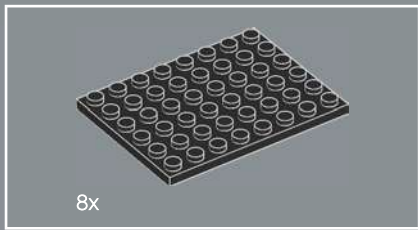

15

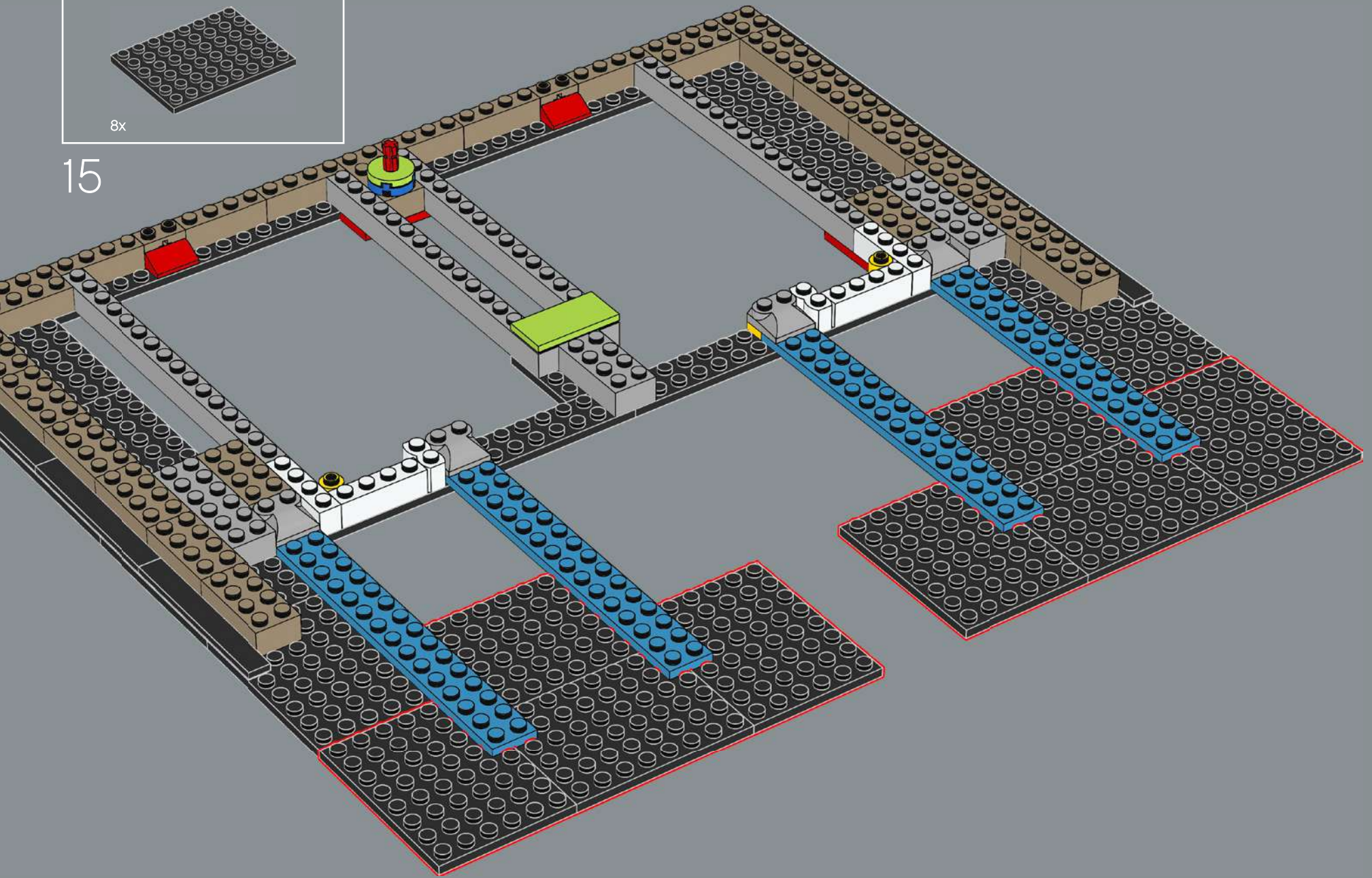

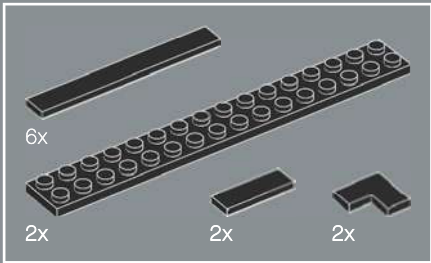

16

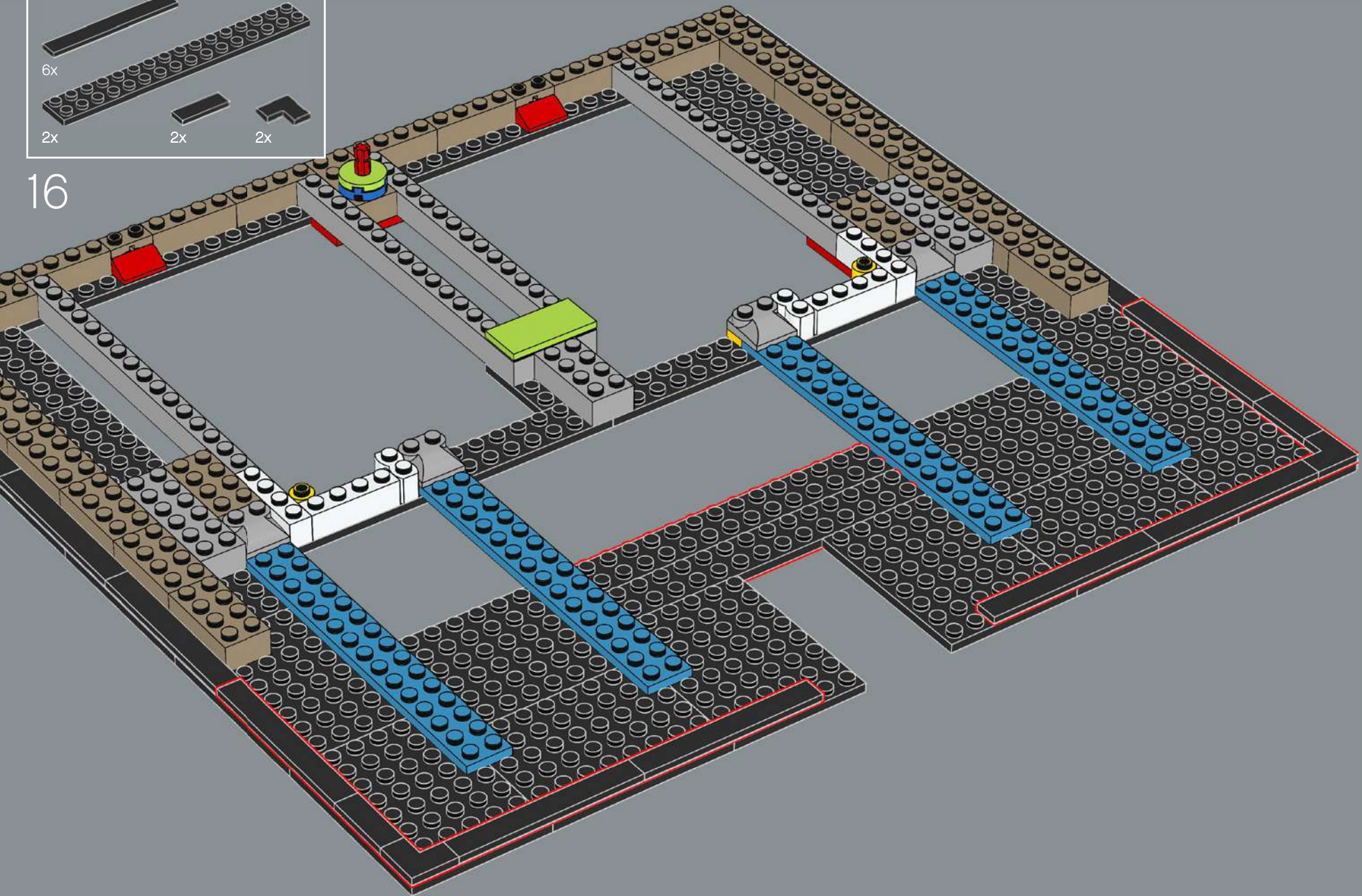

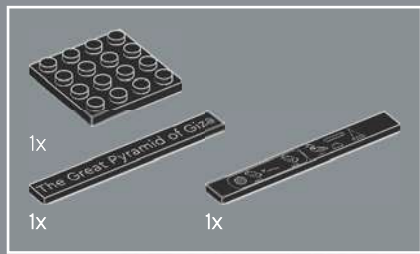

17

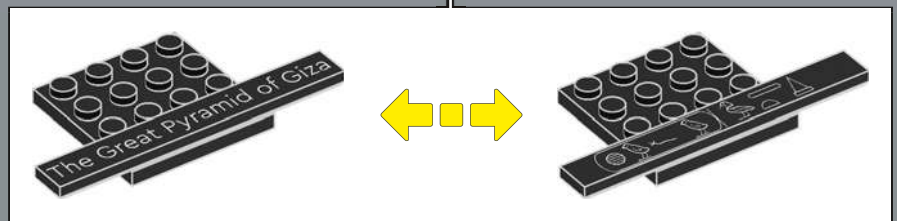
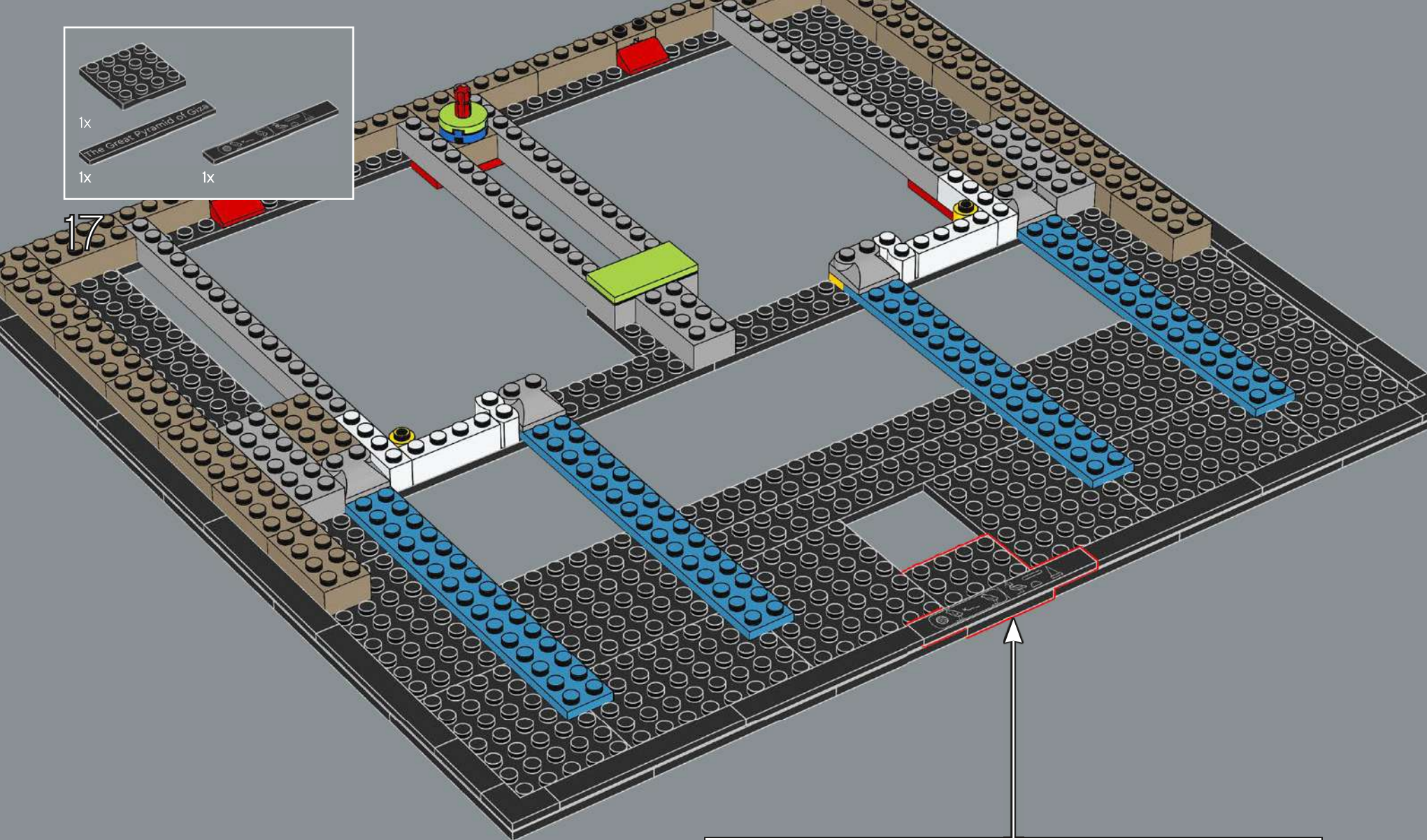

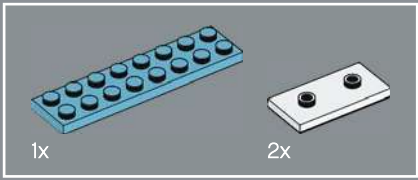

18

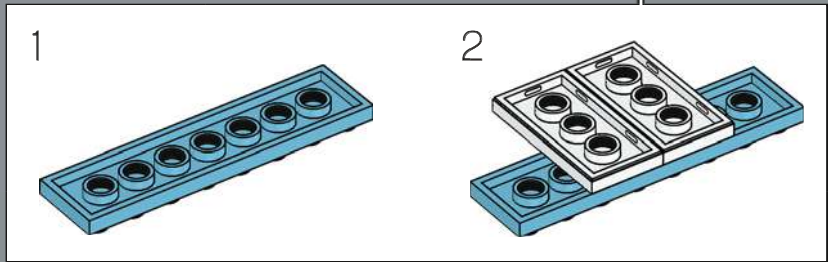
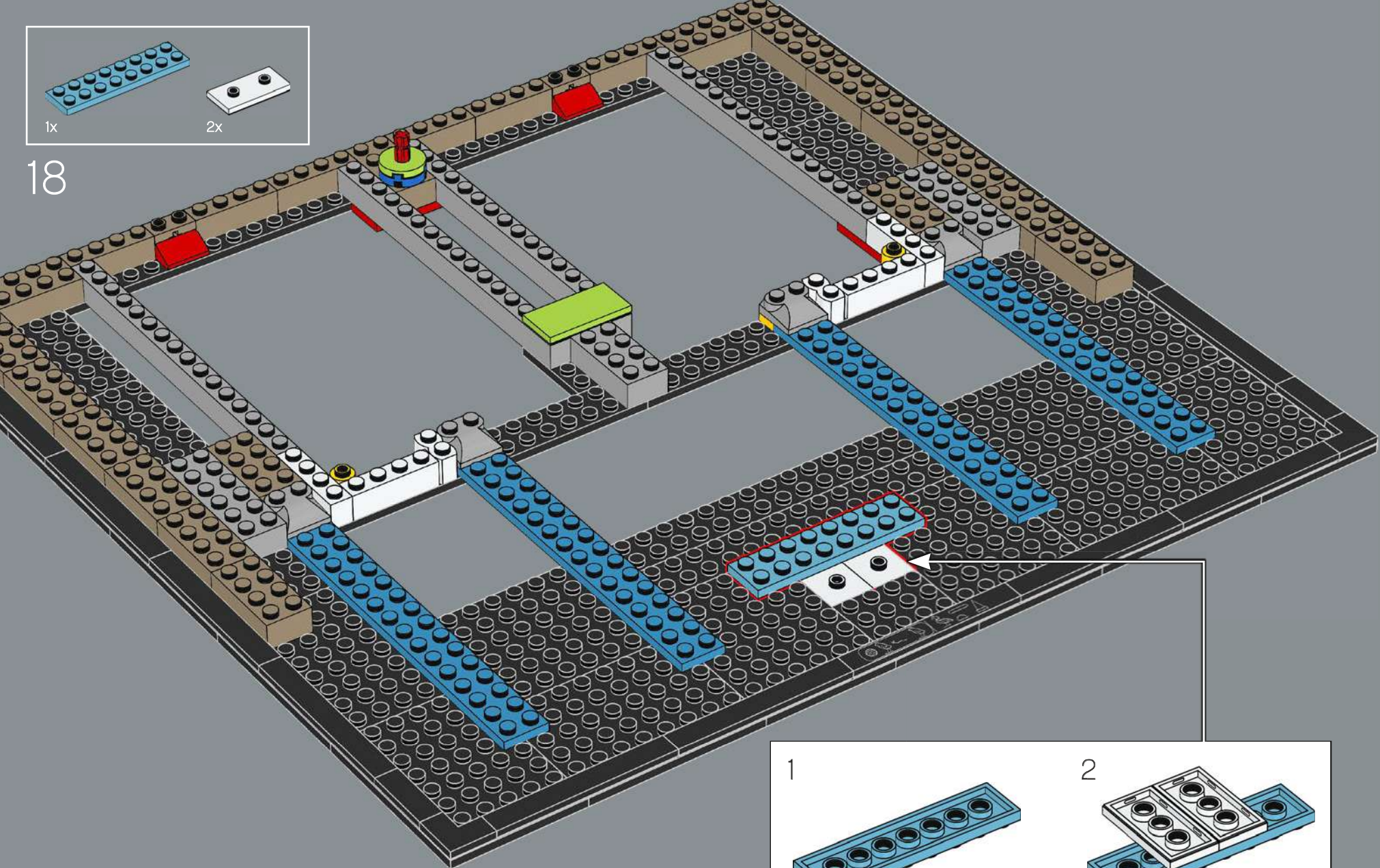

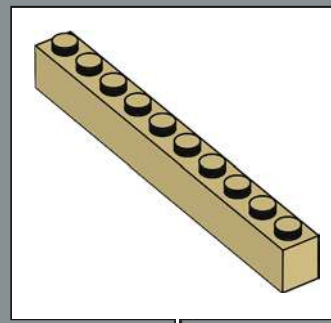
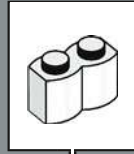
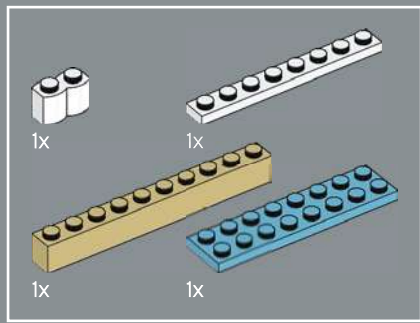

19

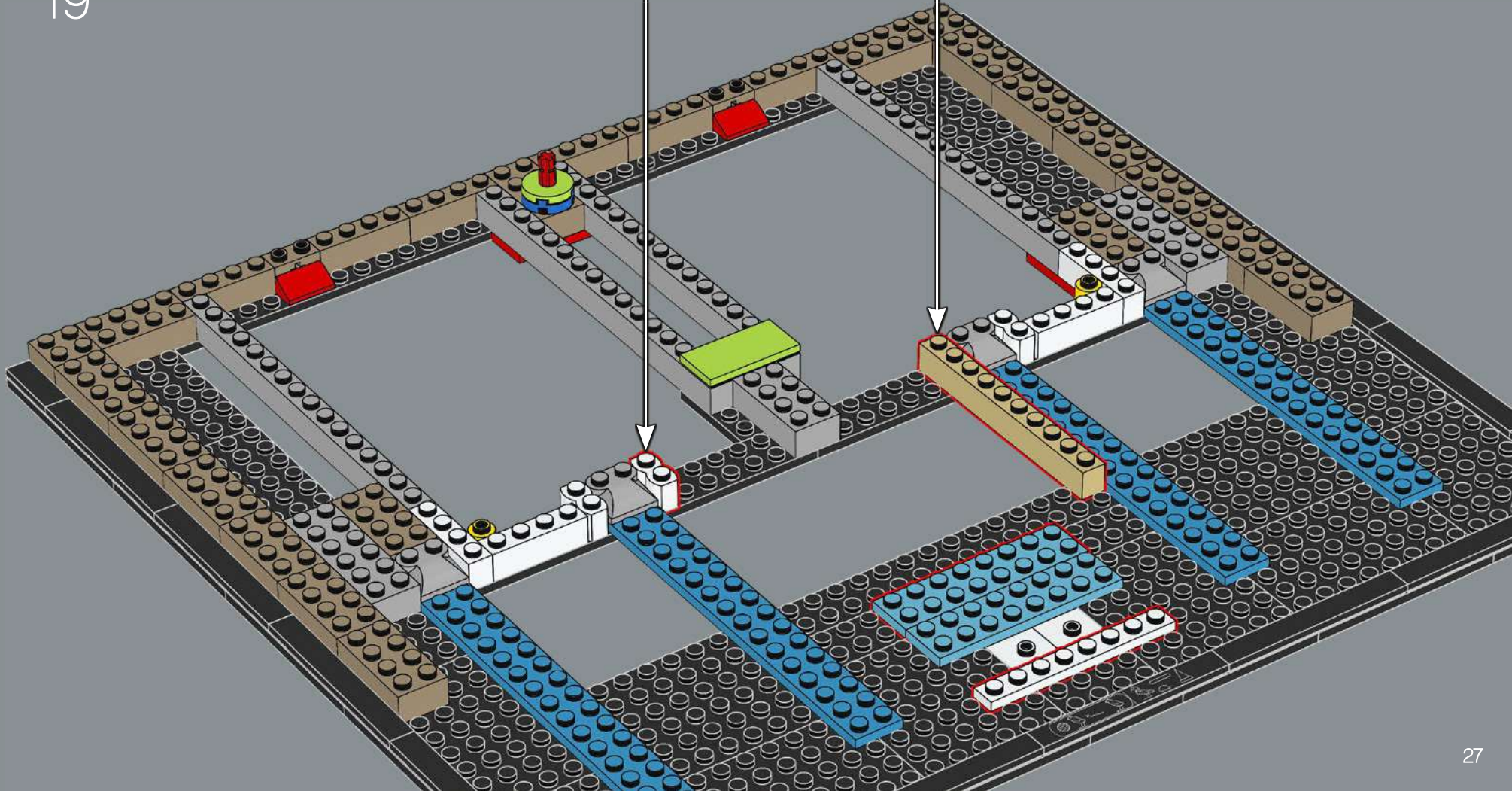

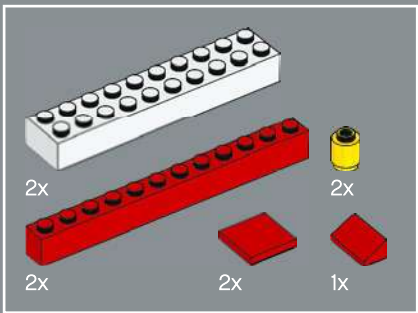

20

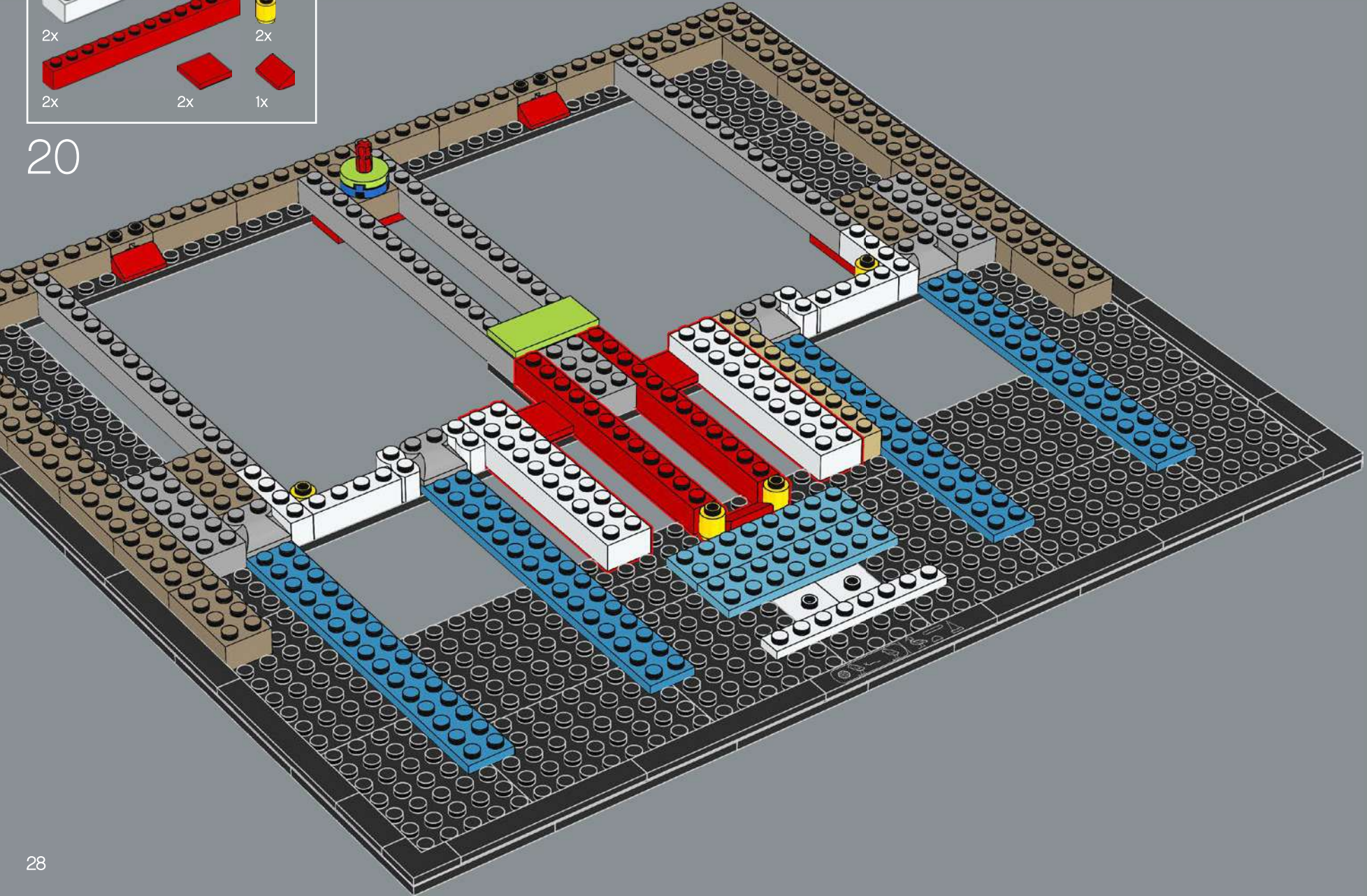

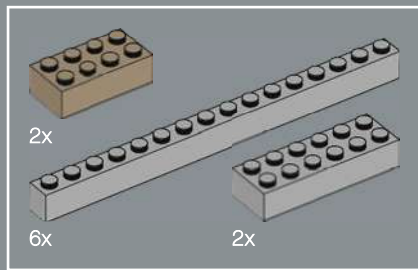

21

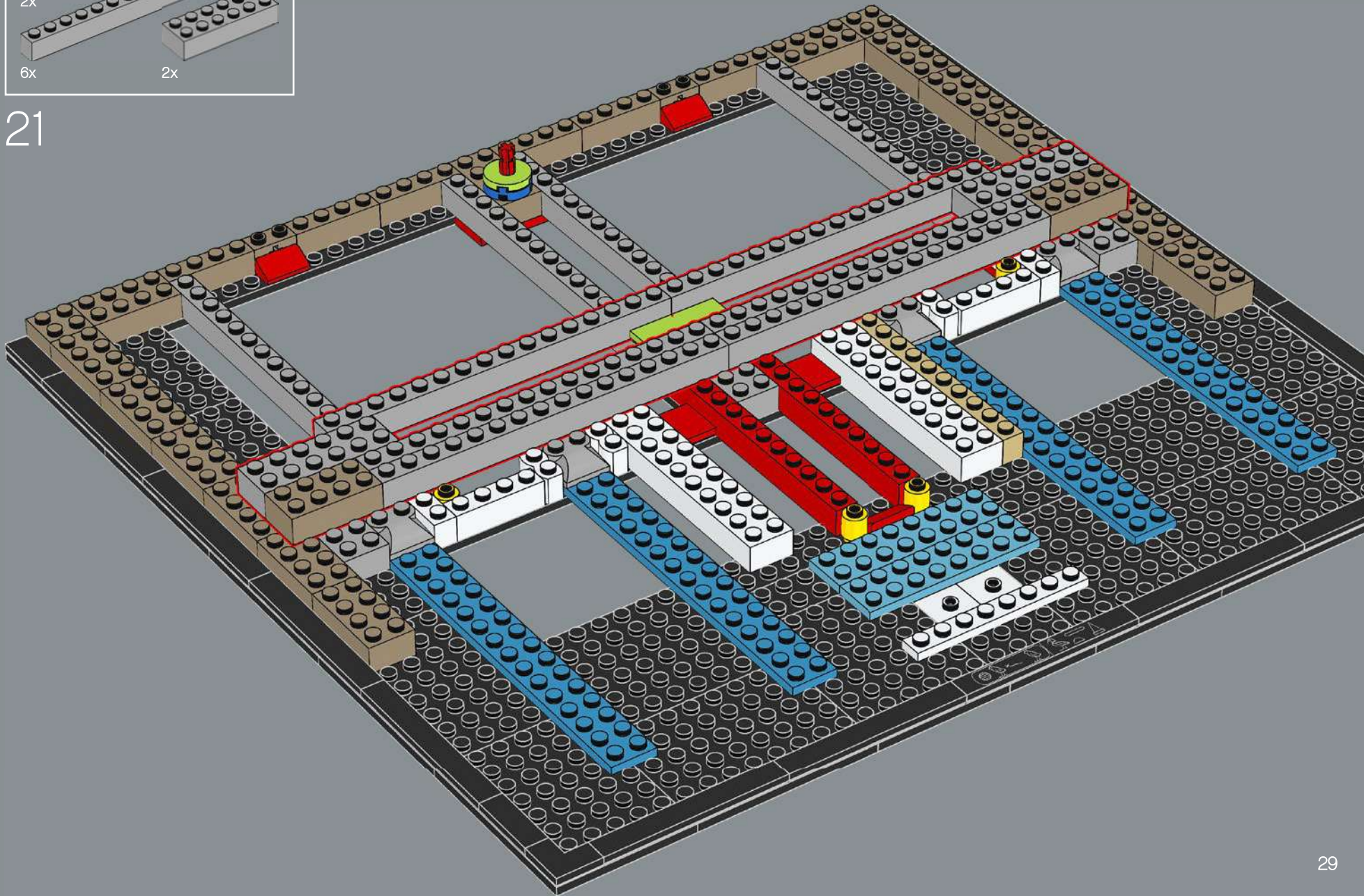

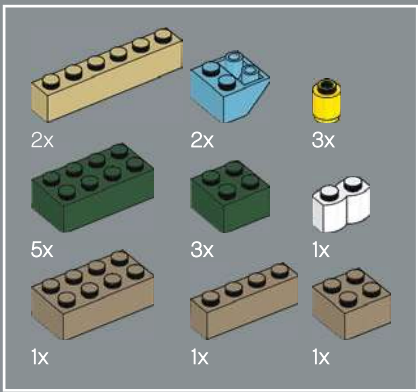

The sides of the Pyramid's base are closely aligned to the four geographic directions of North, South, East and West.



22

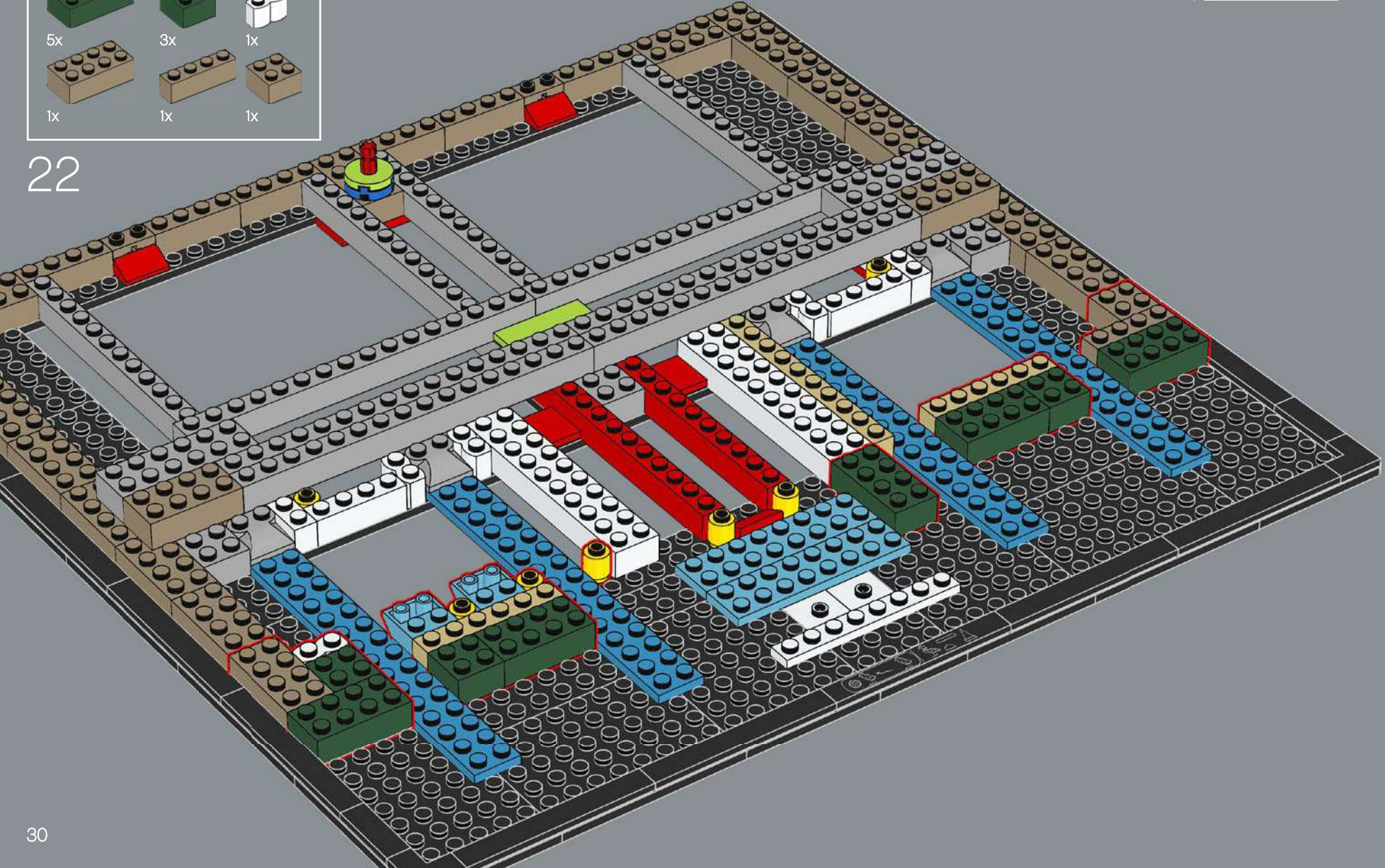



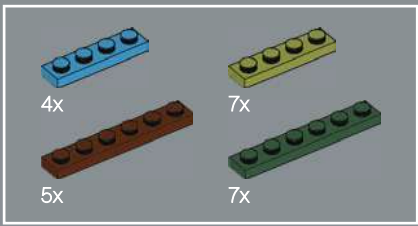

23

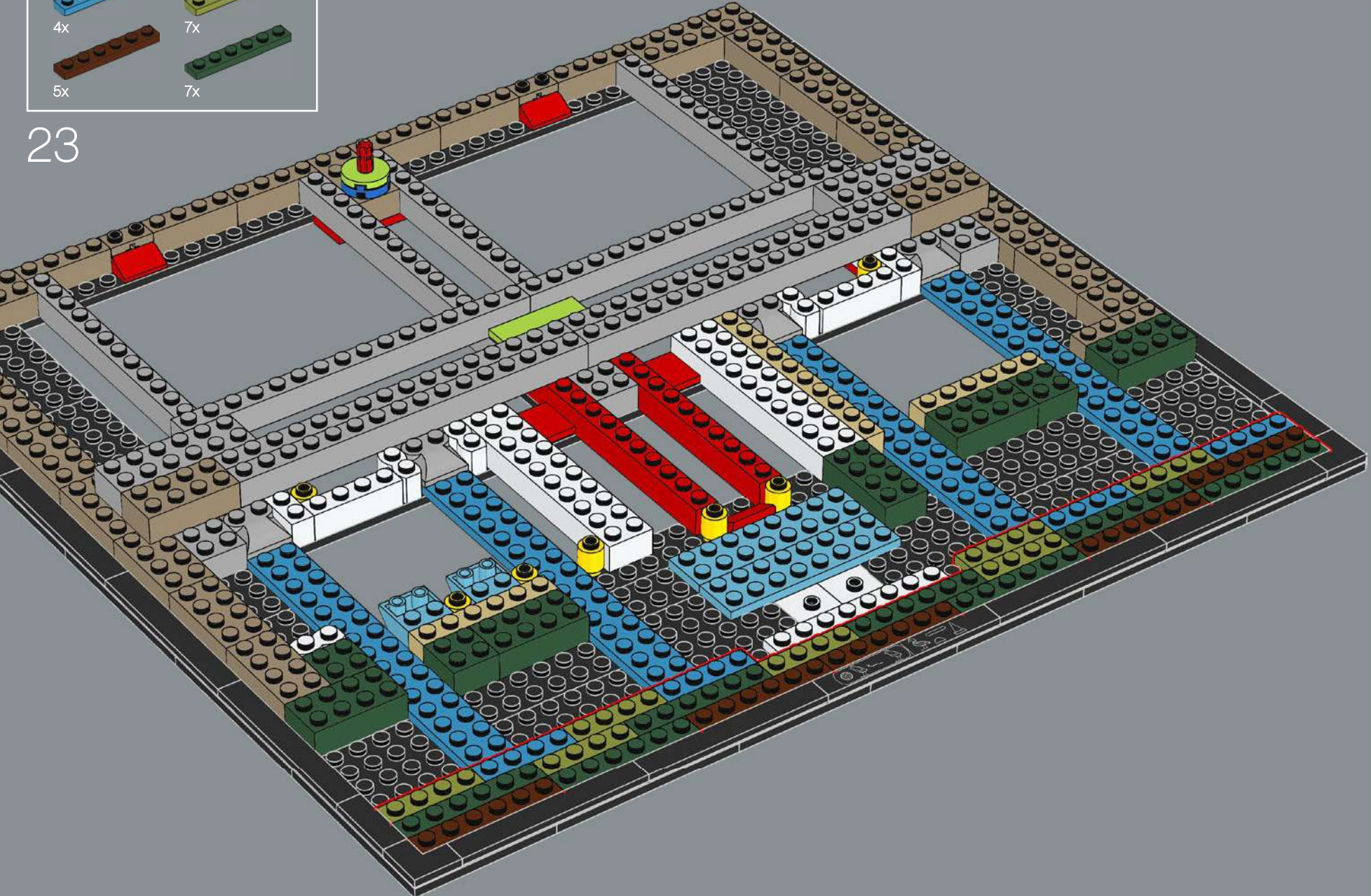

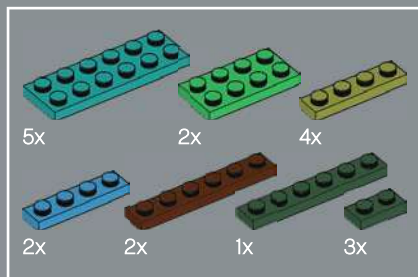

24

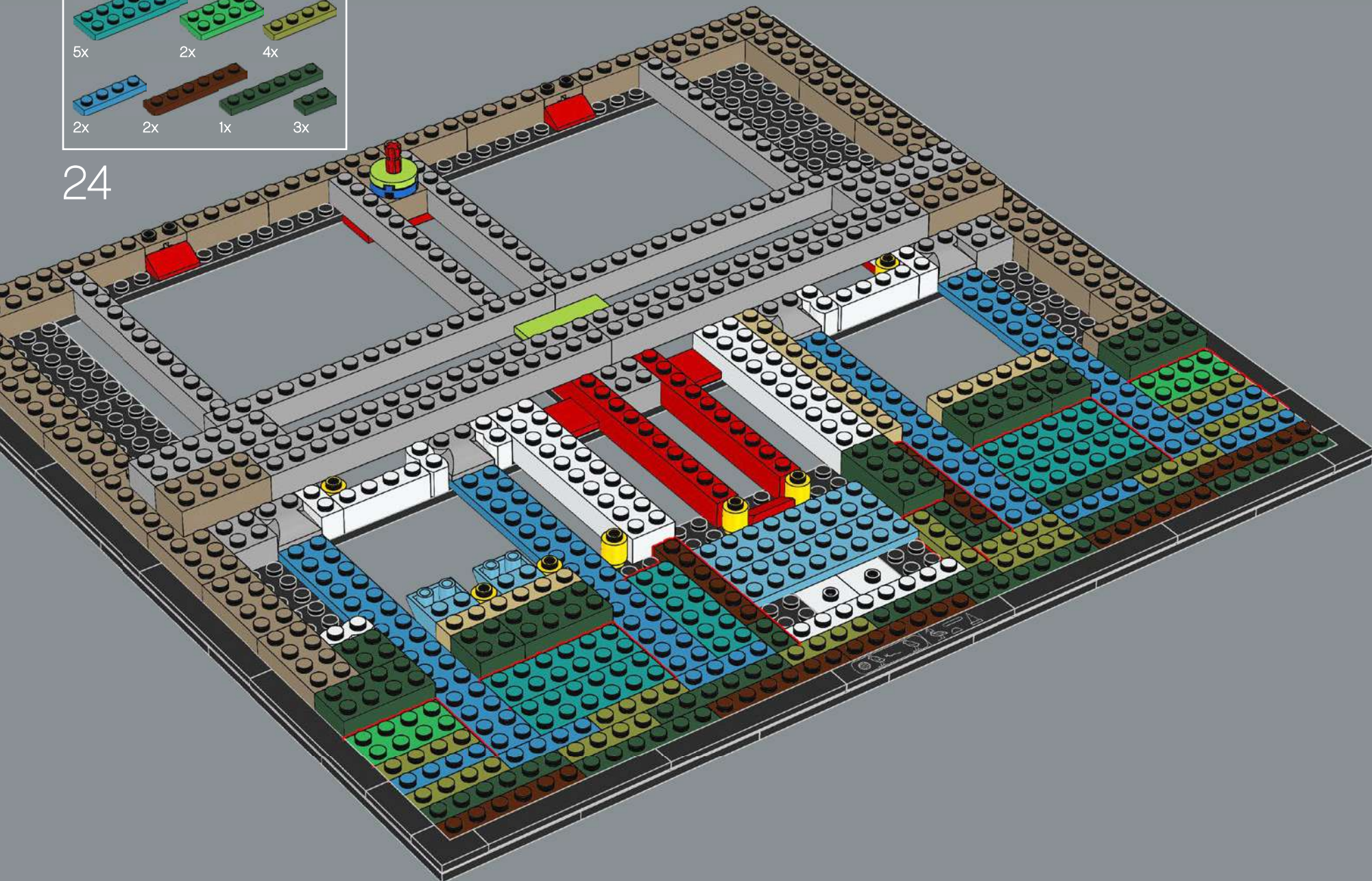

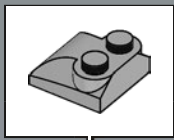
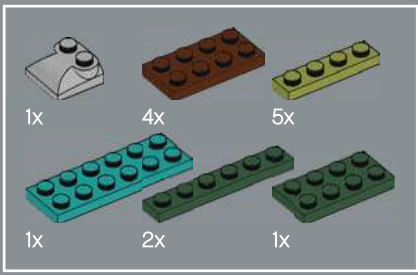

25

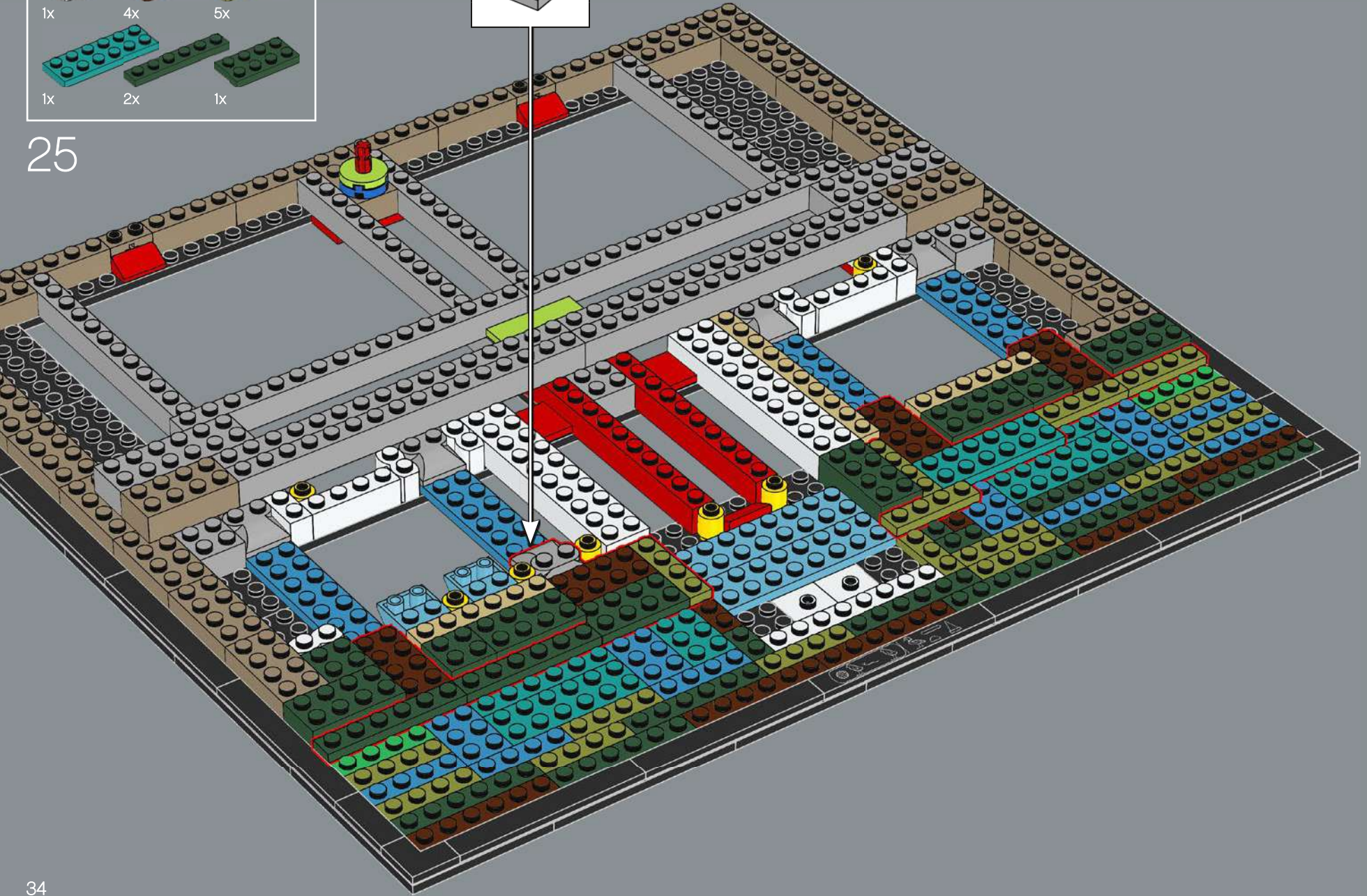

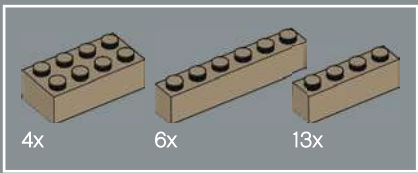

27

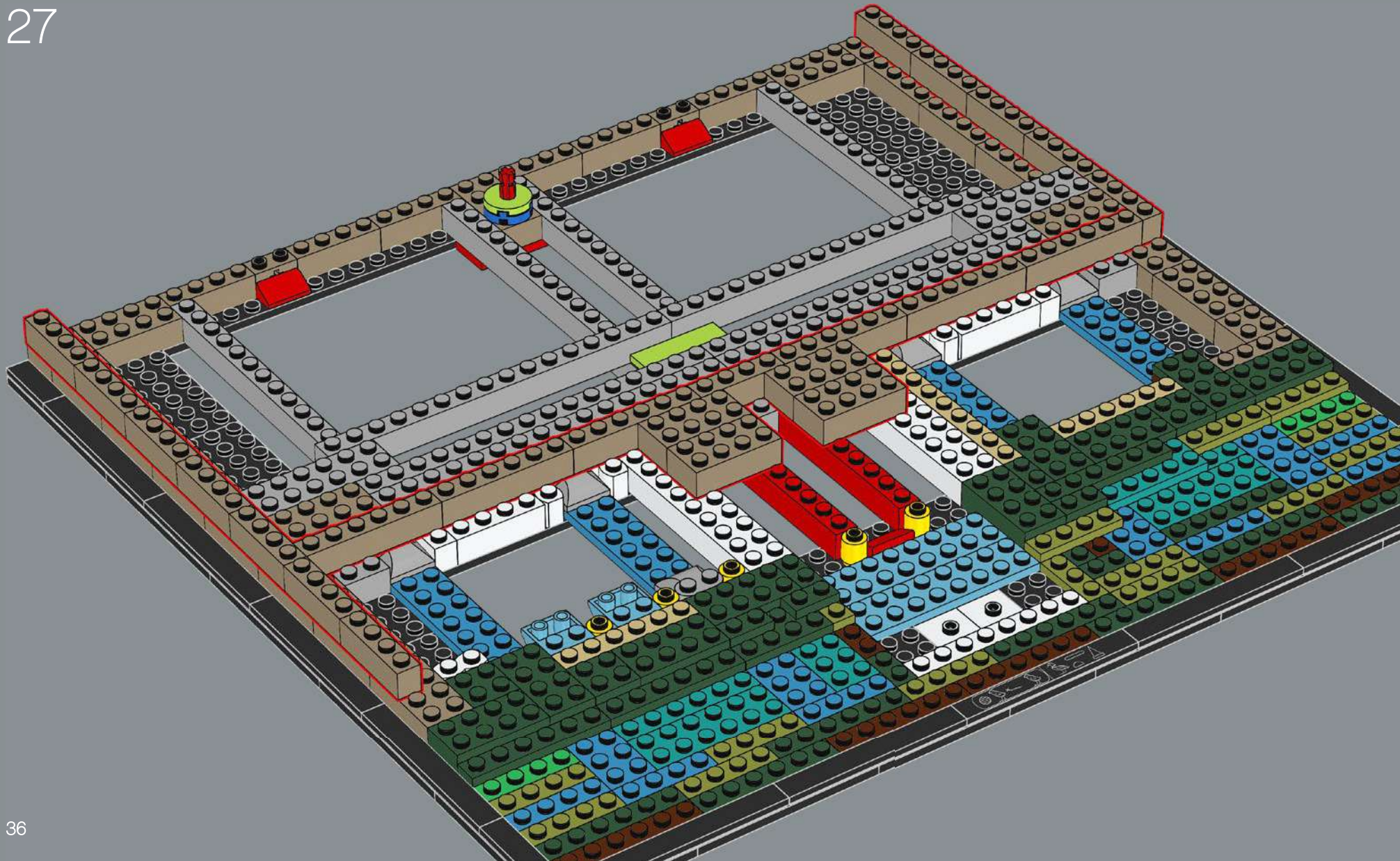

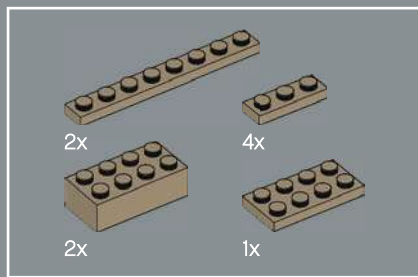

28

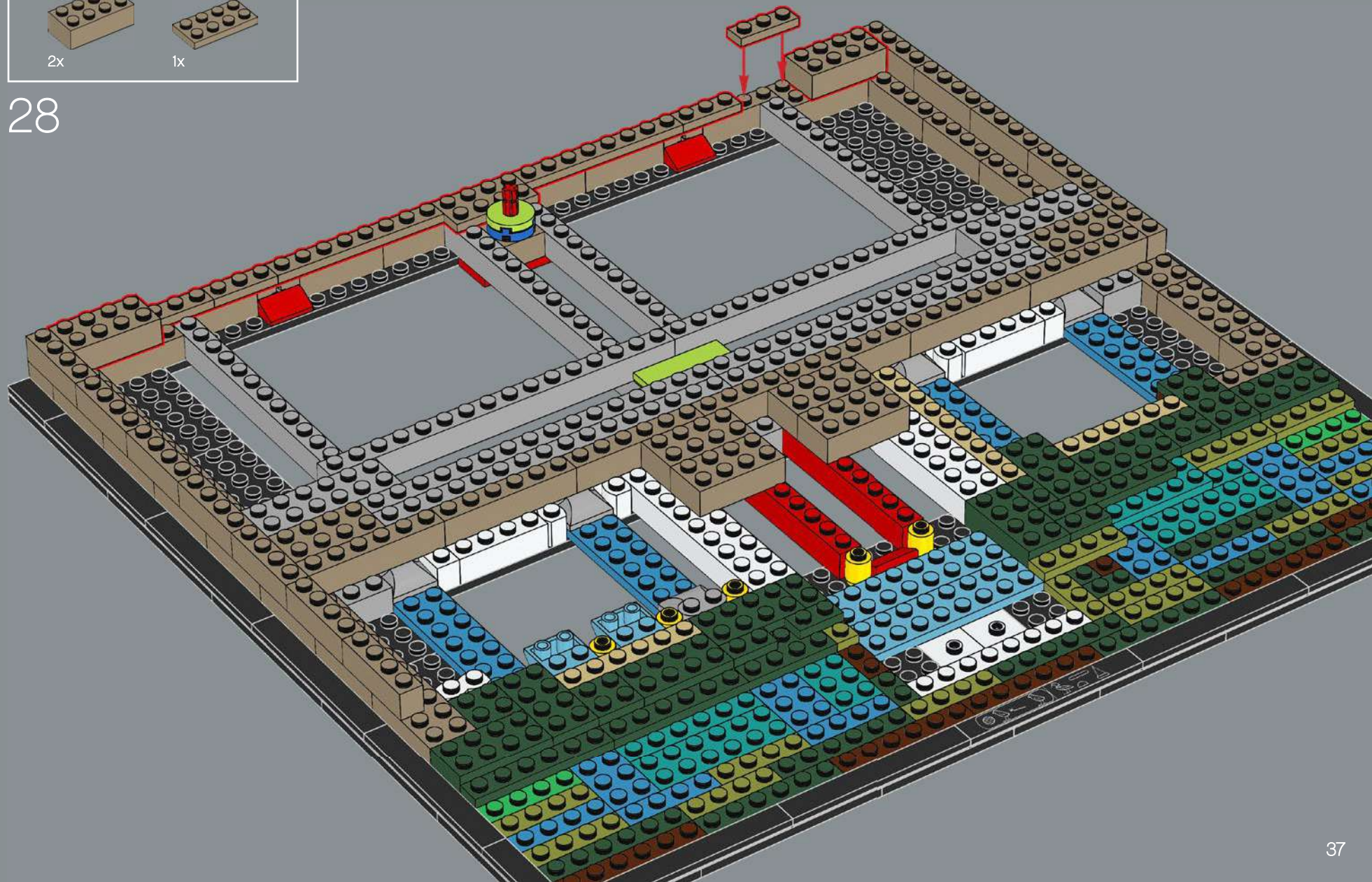

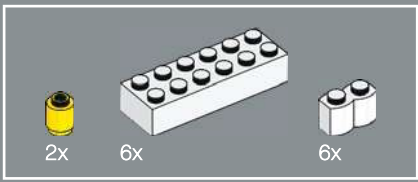

29

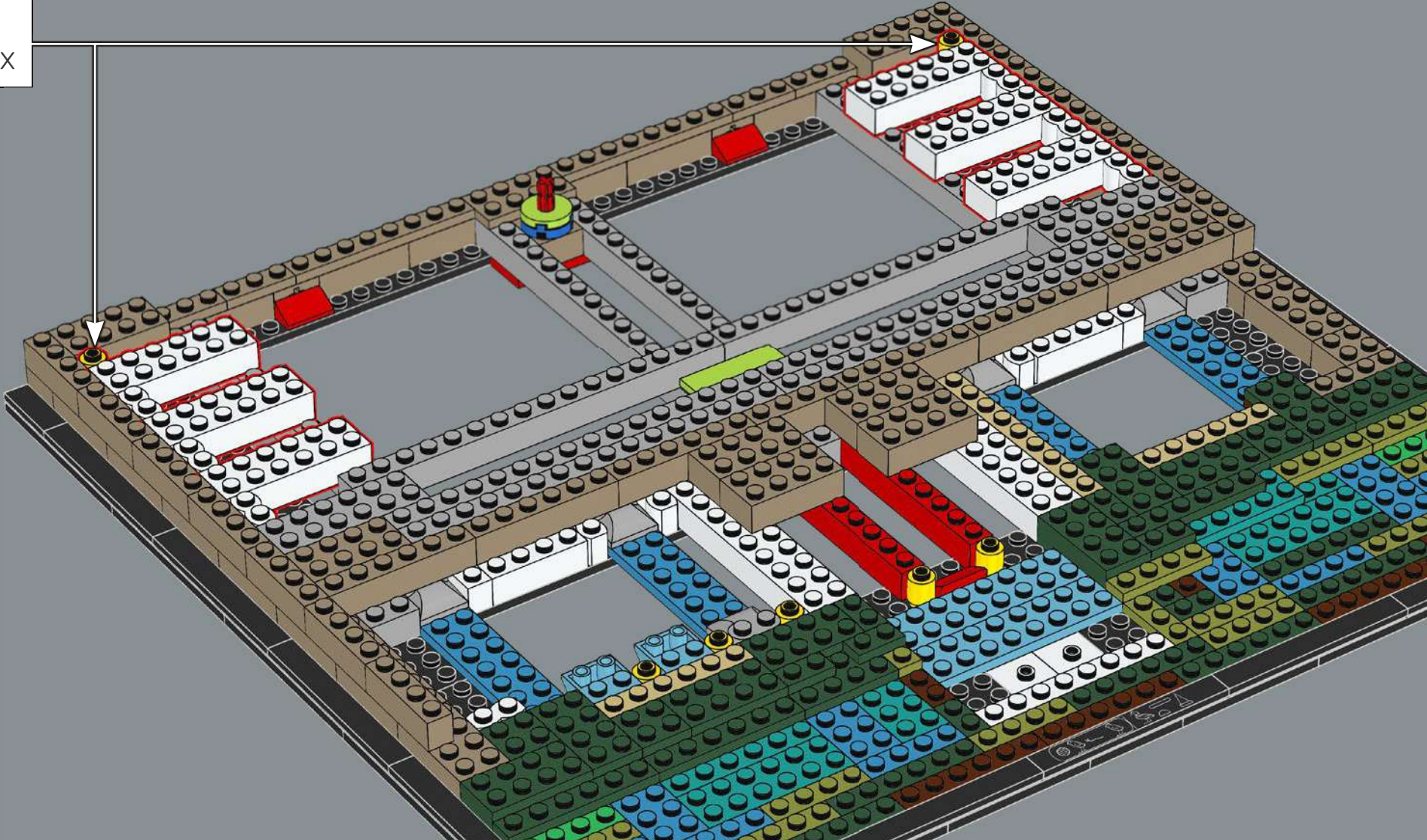

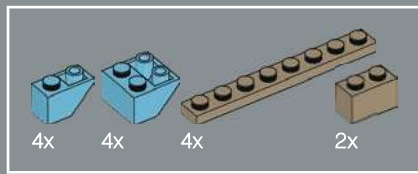

30

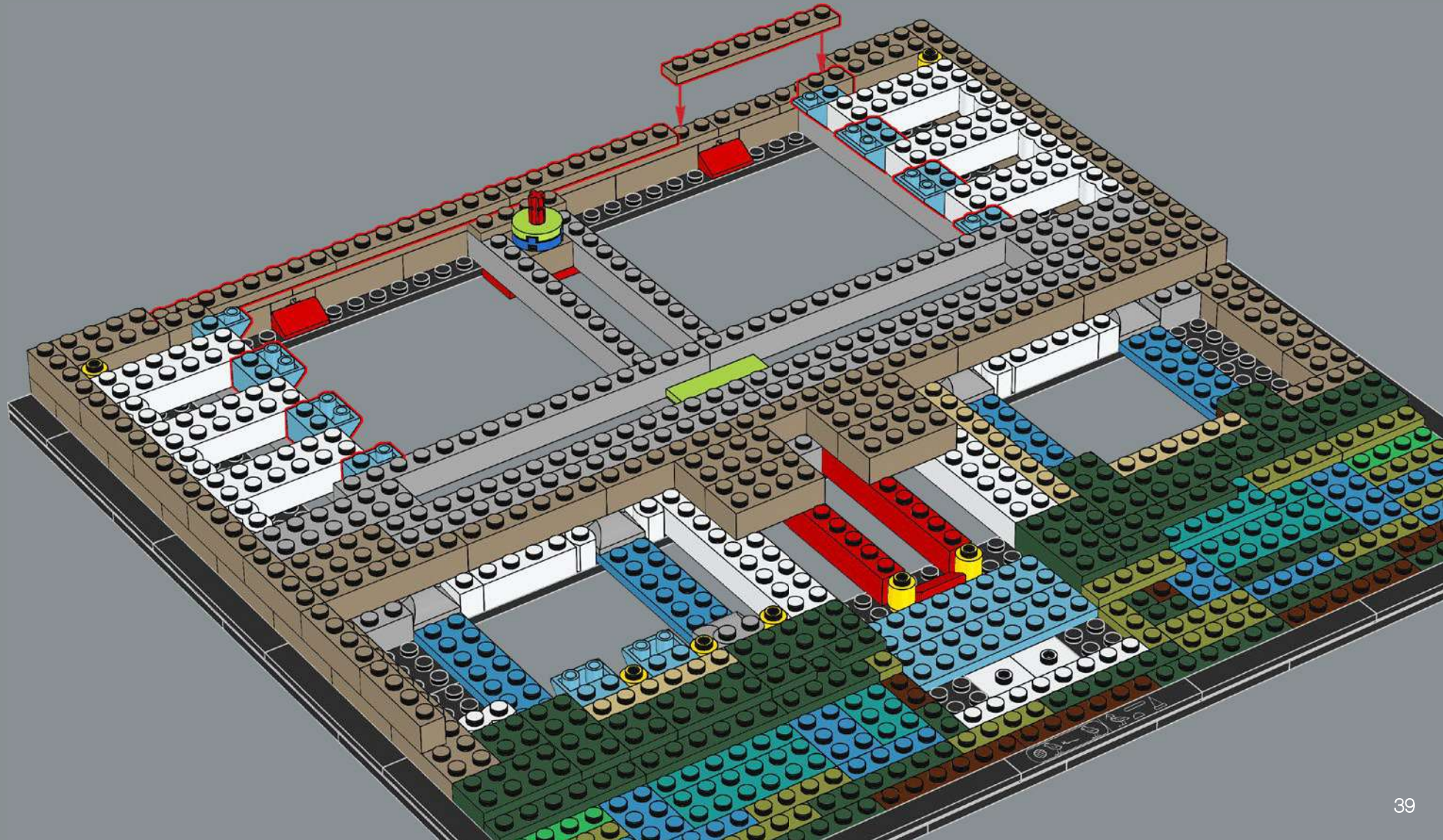

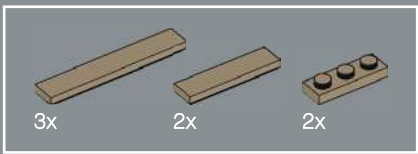

31

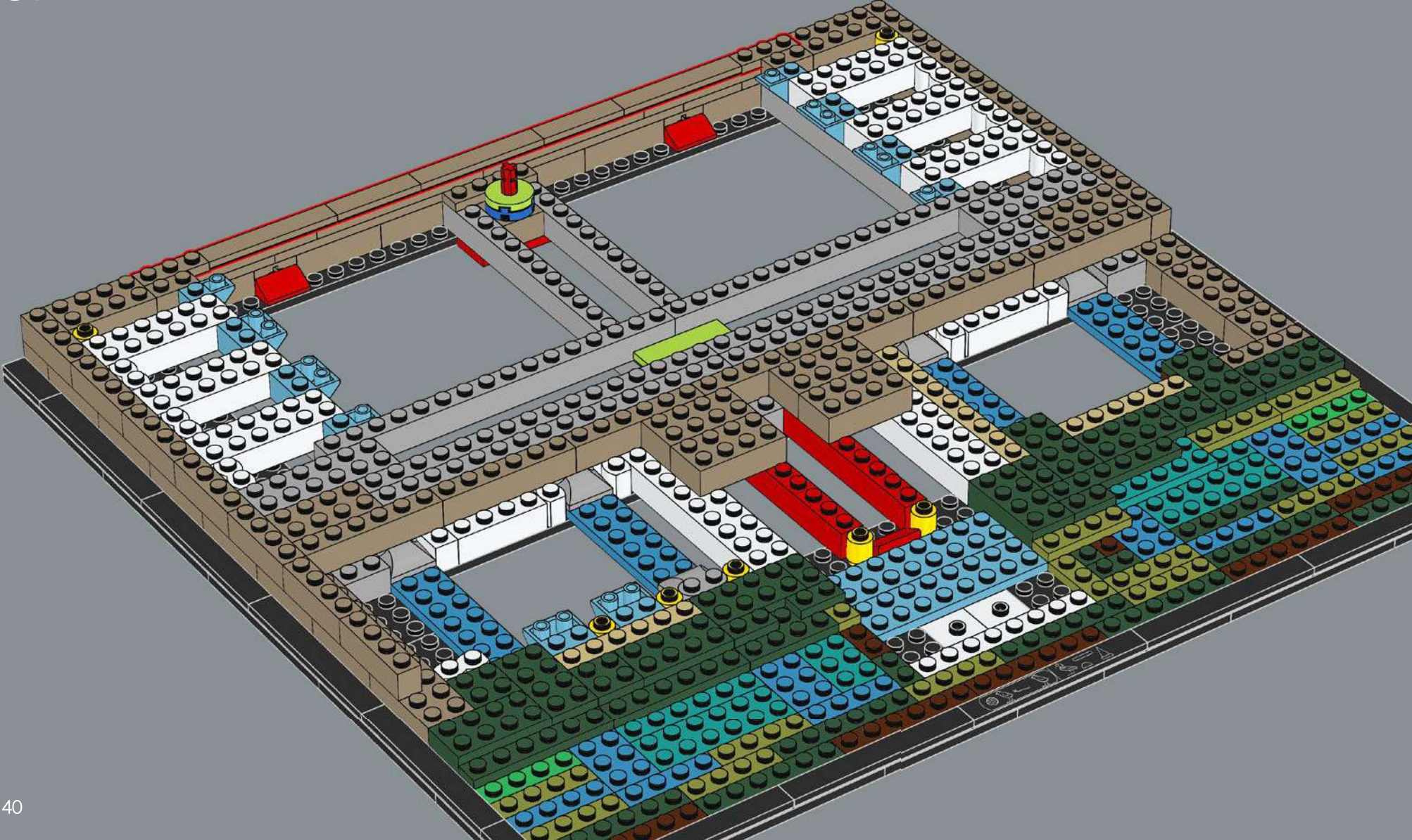

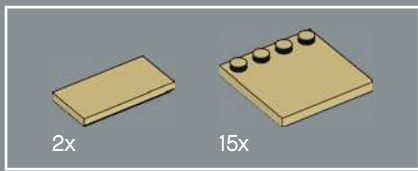

32

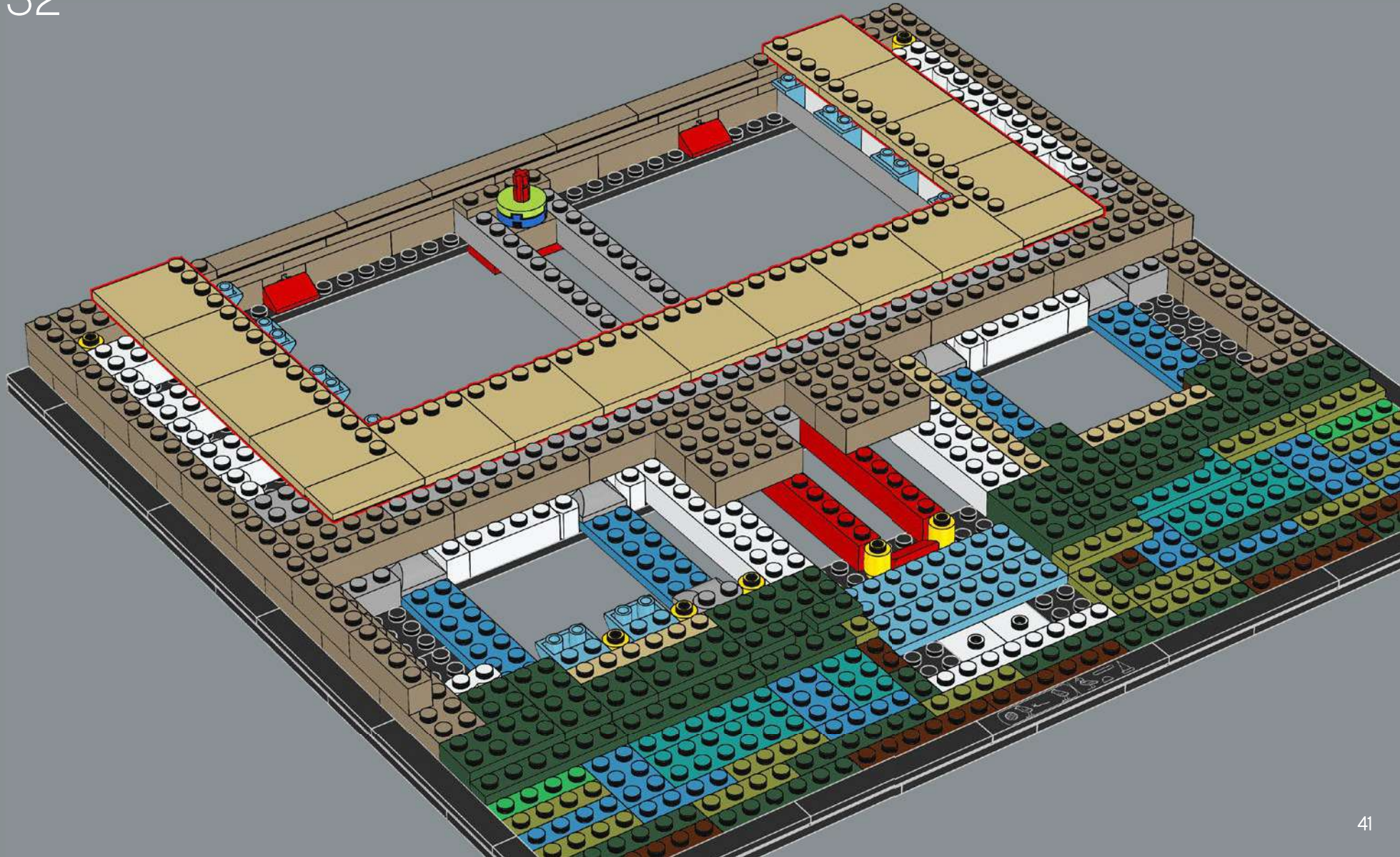

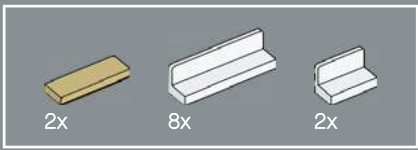

33

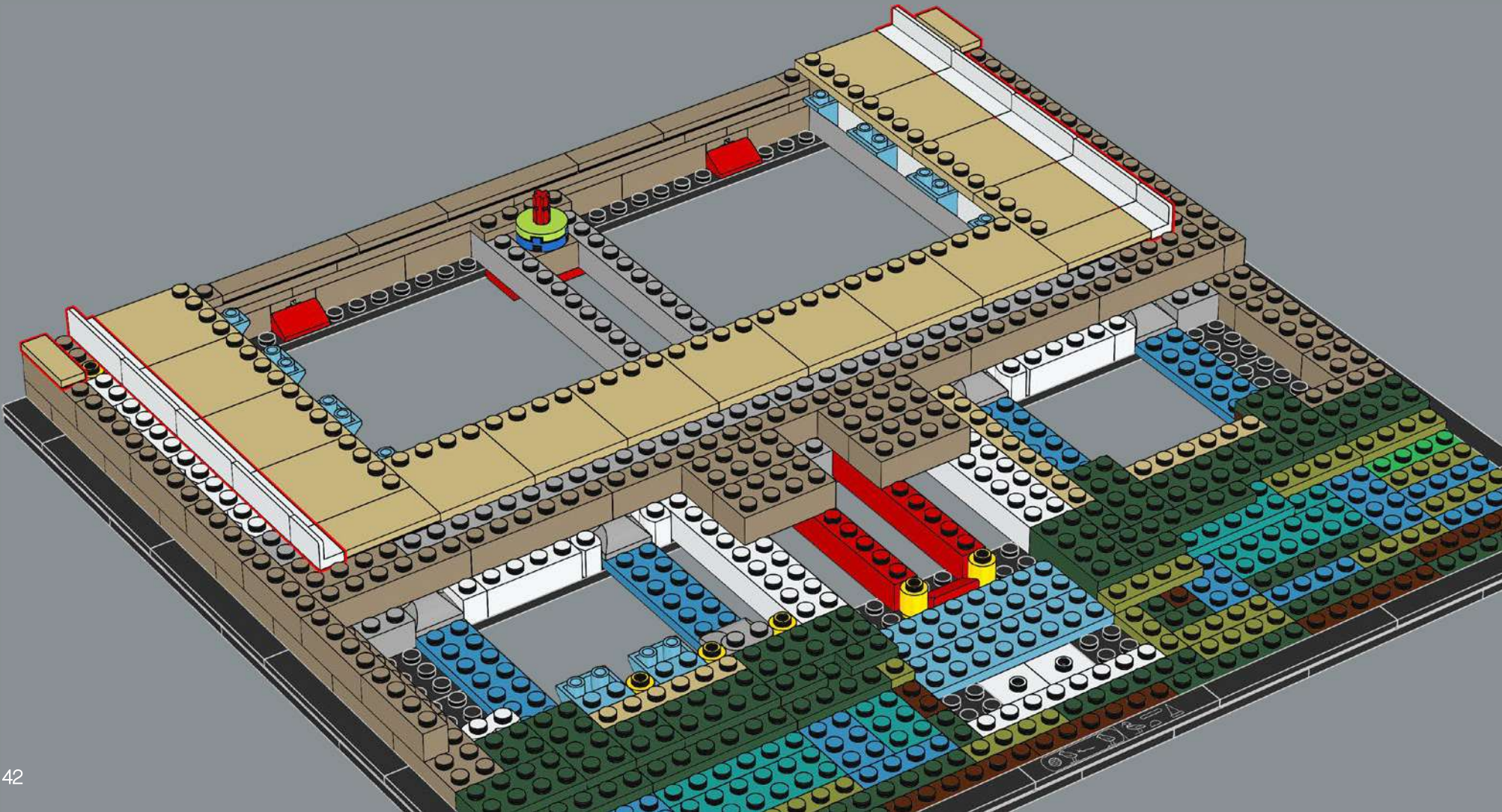

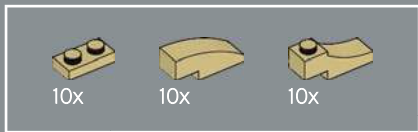

Rolling sand dunes of the nearby desert are placed at the edge of the otherwise lush model scene.

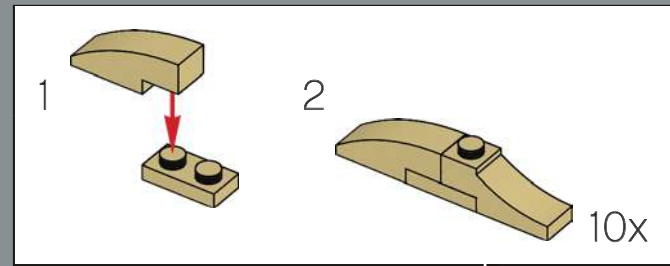

34

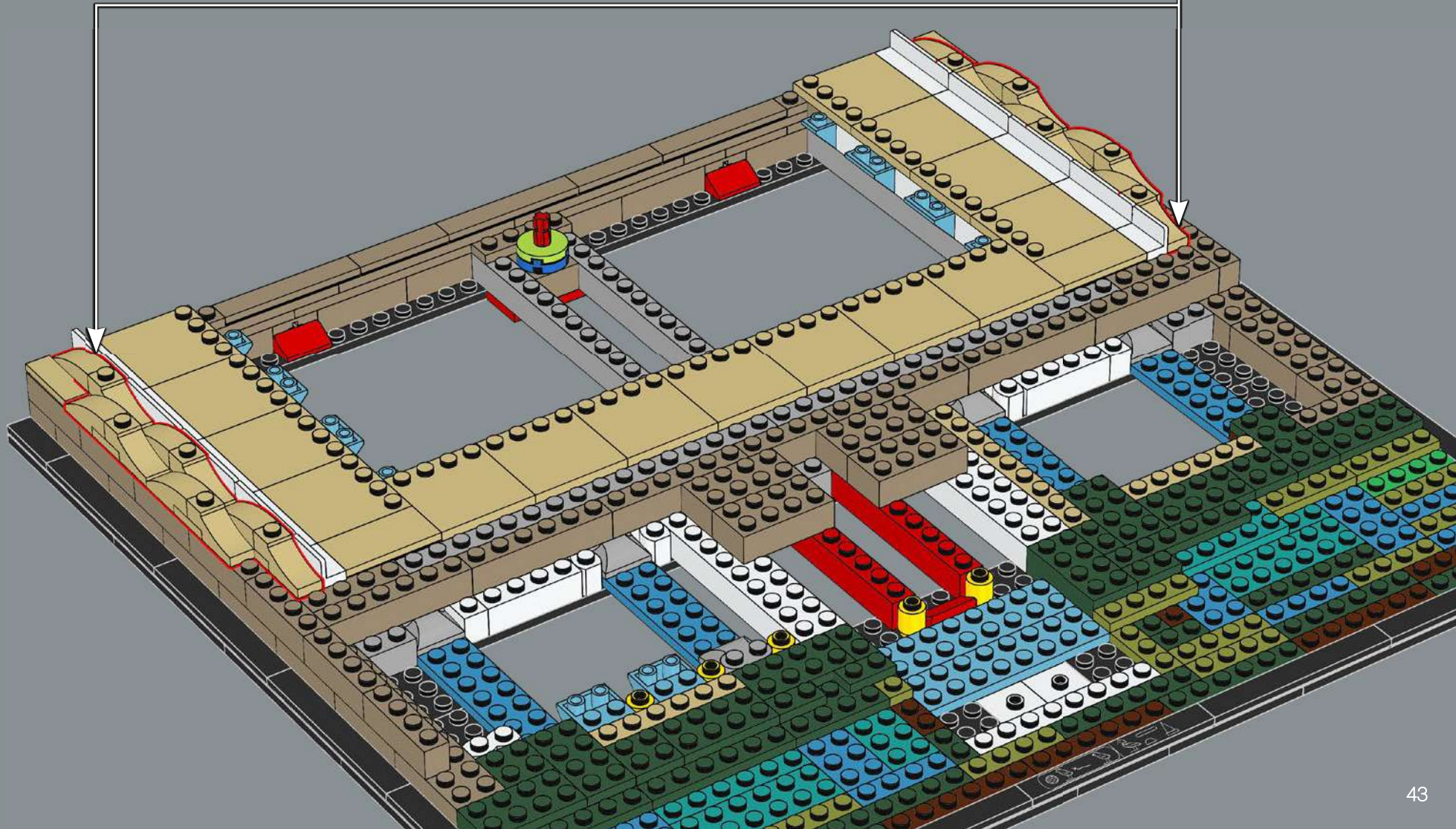

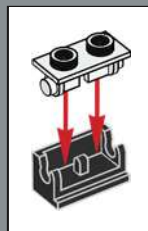
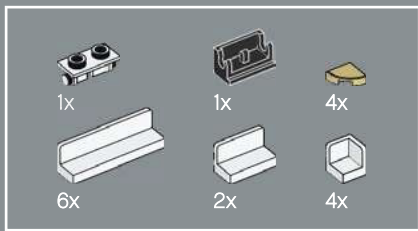

35

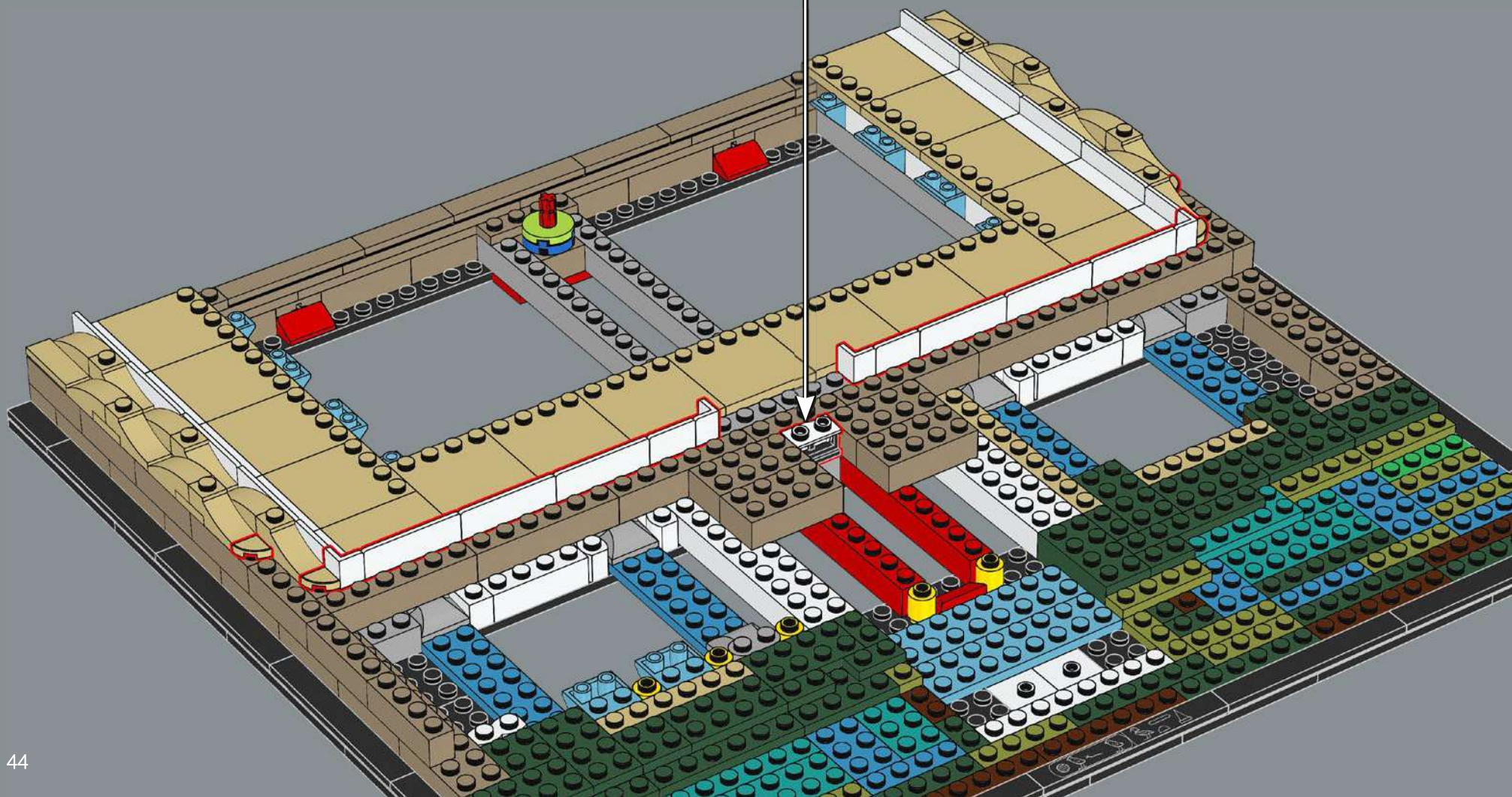

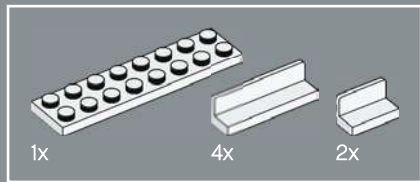

36

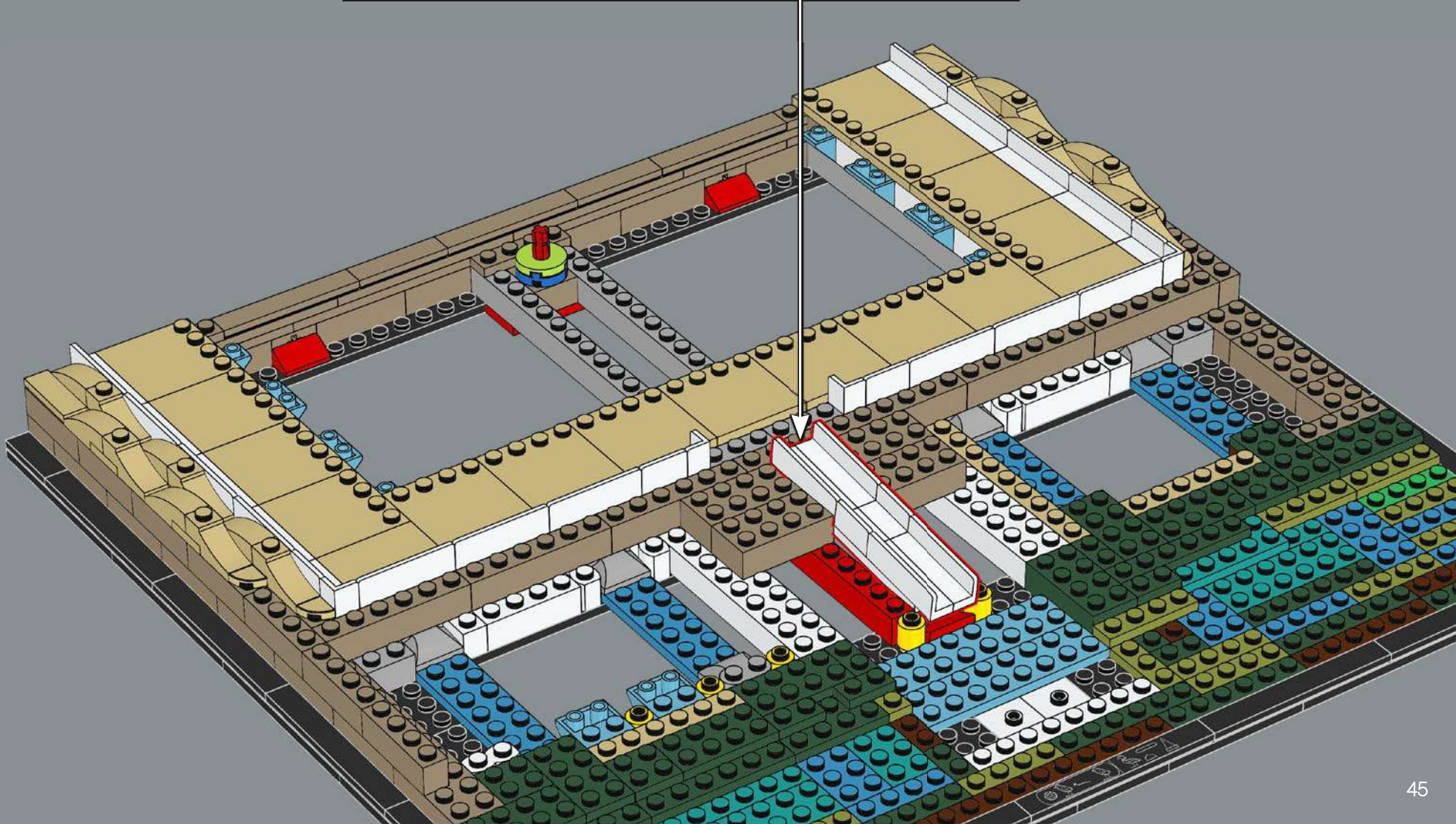
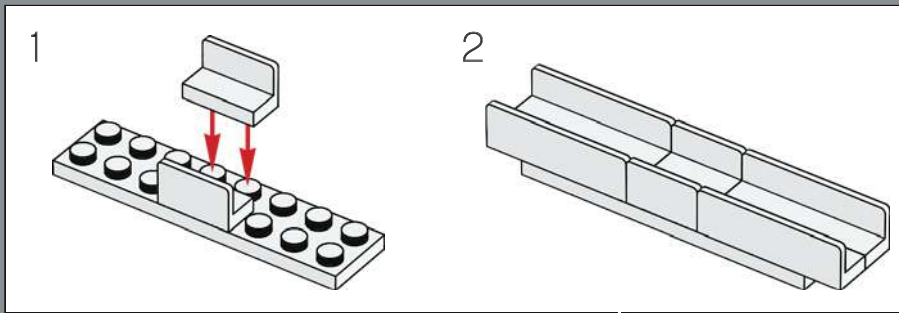



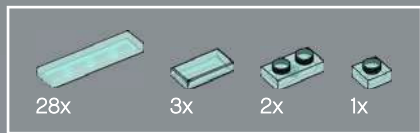

37

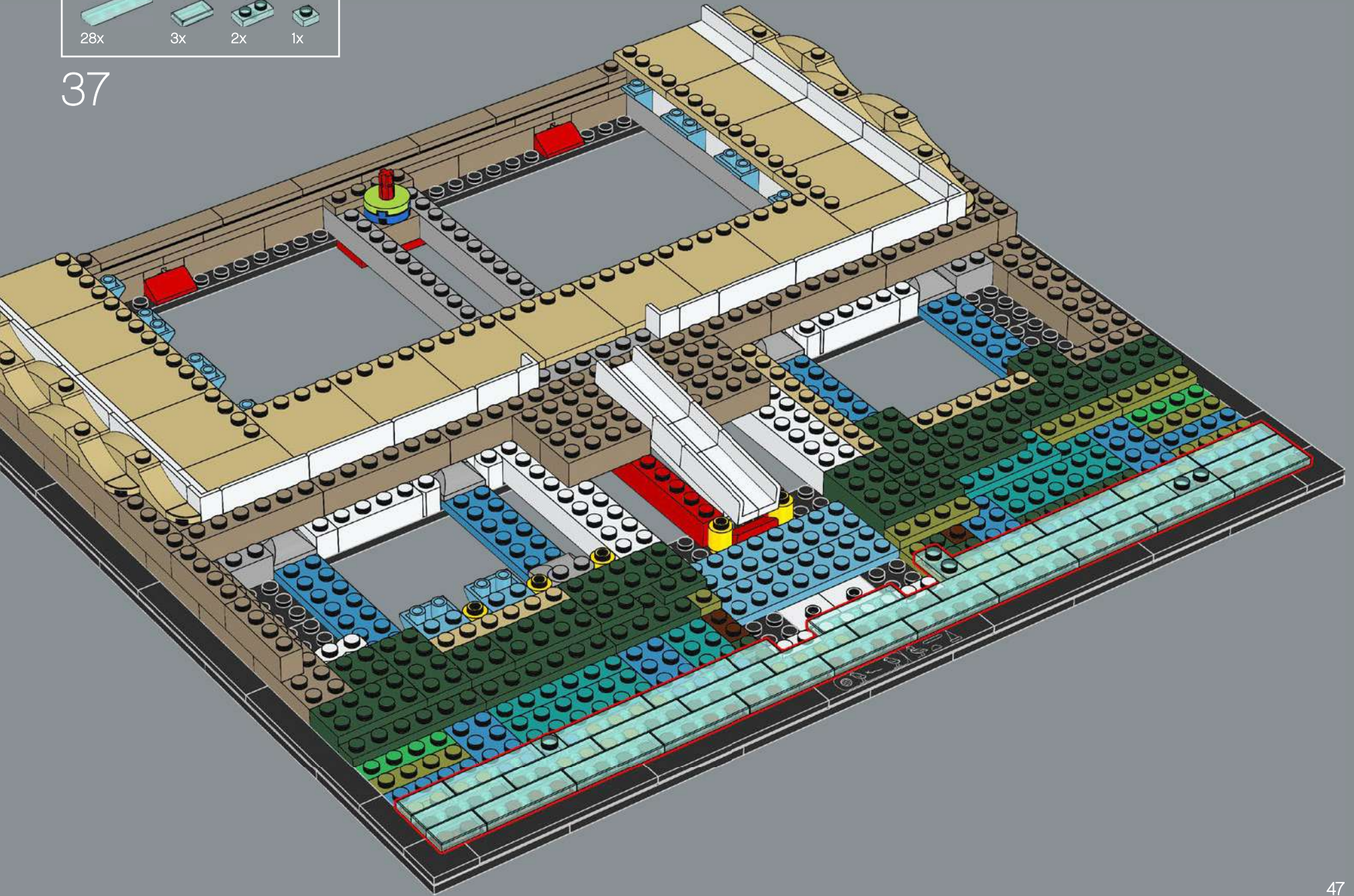

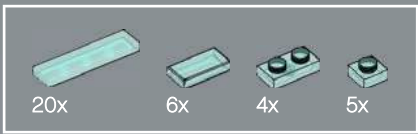

38

Different colours of plates are used to give depth to the river.

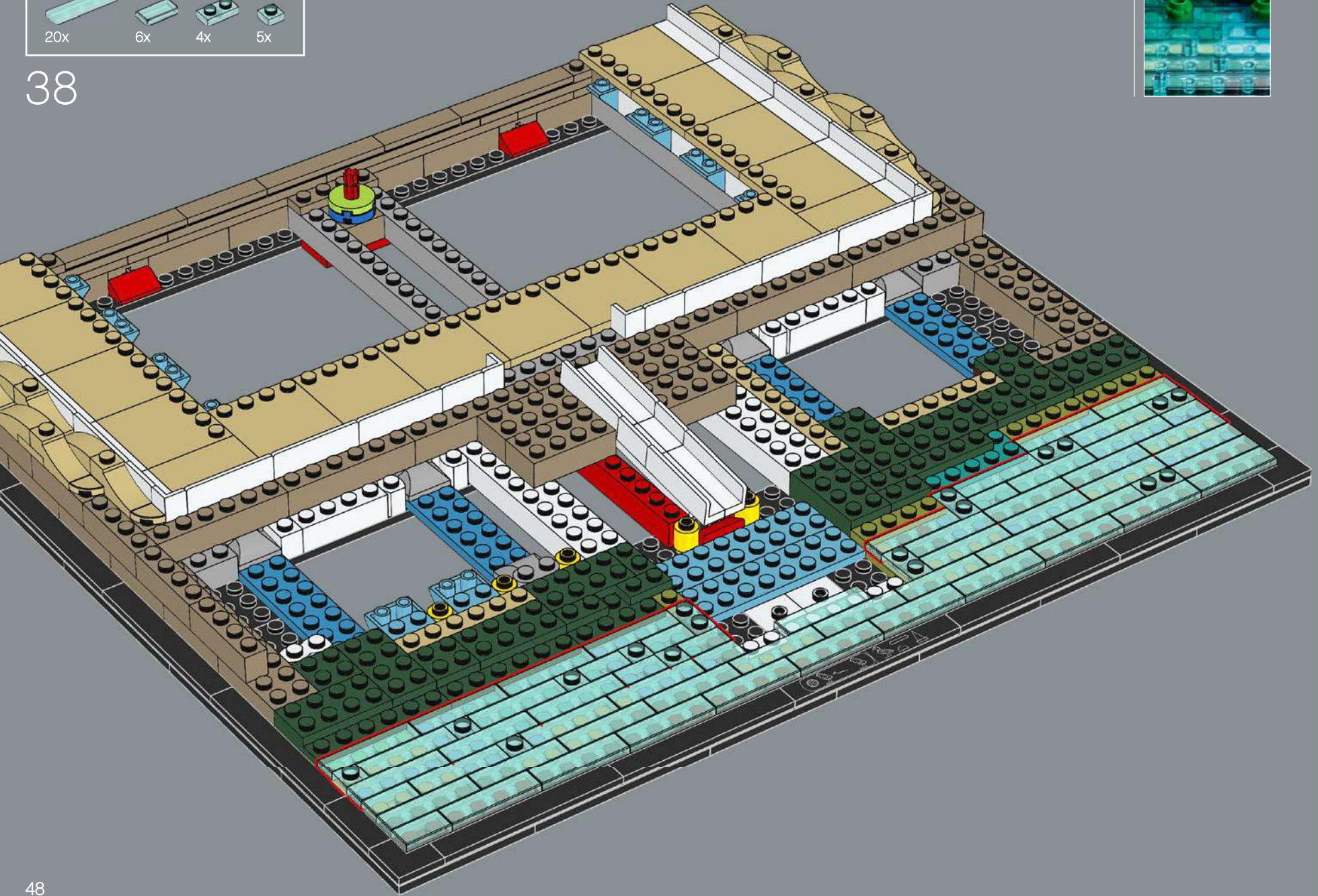

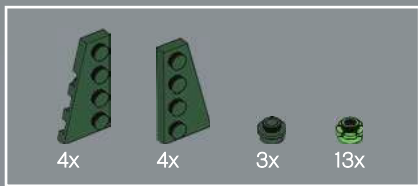

39

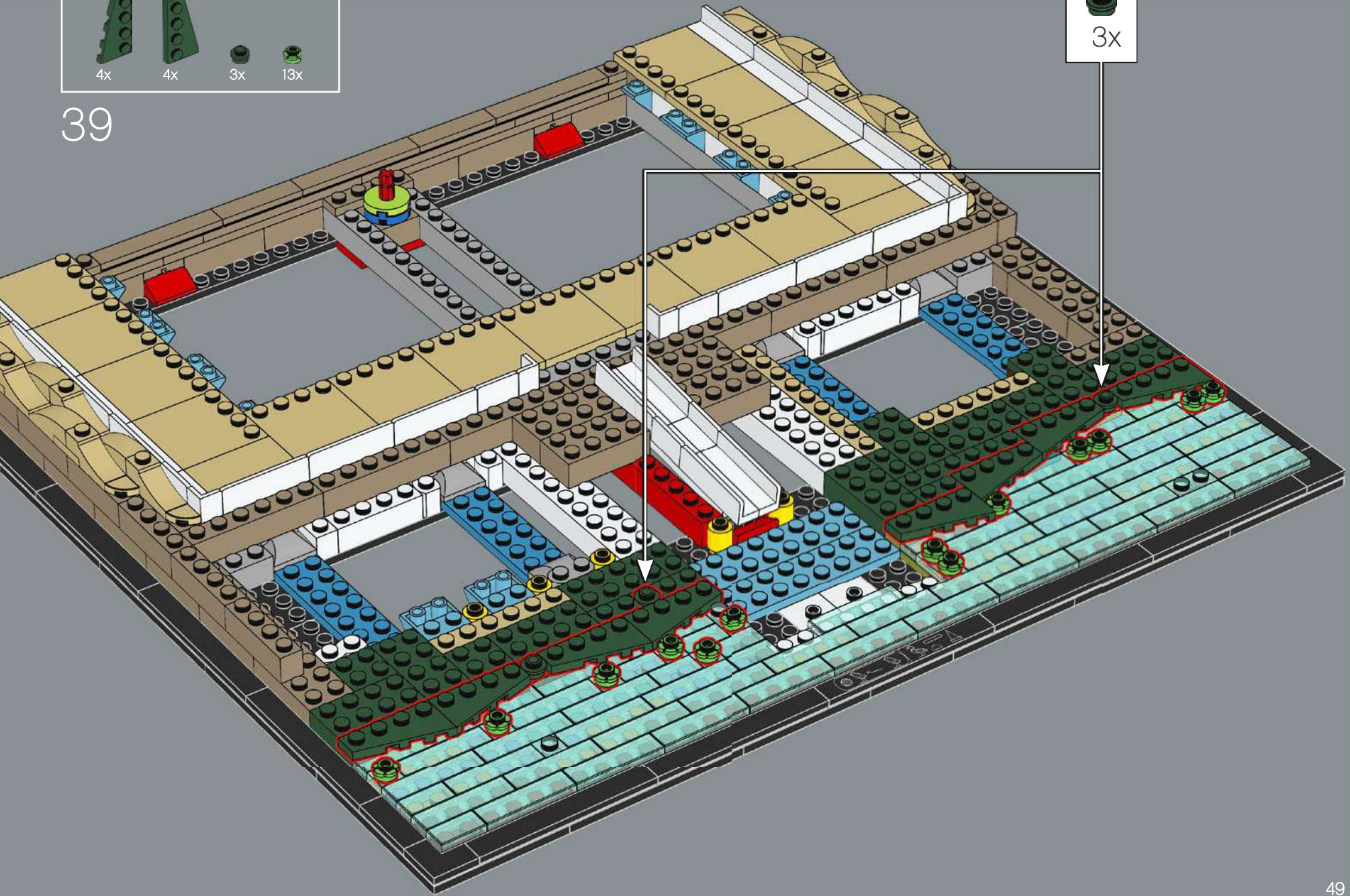

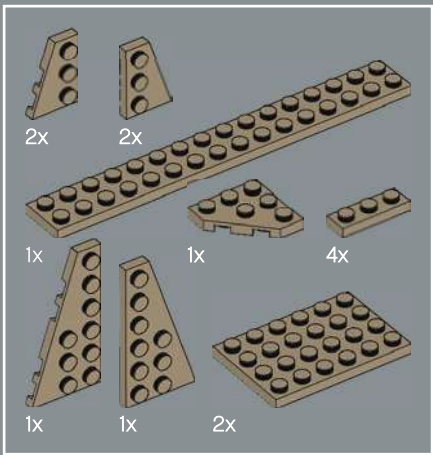

40

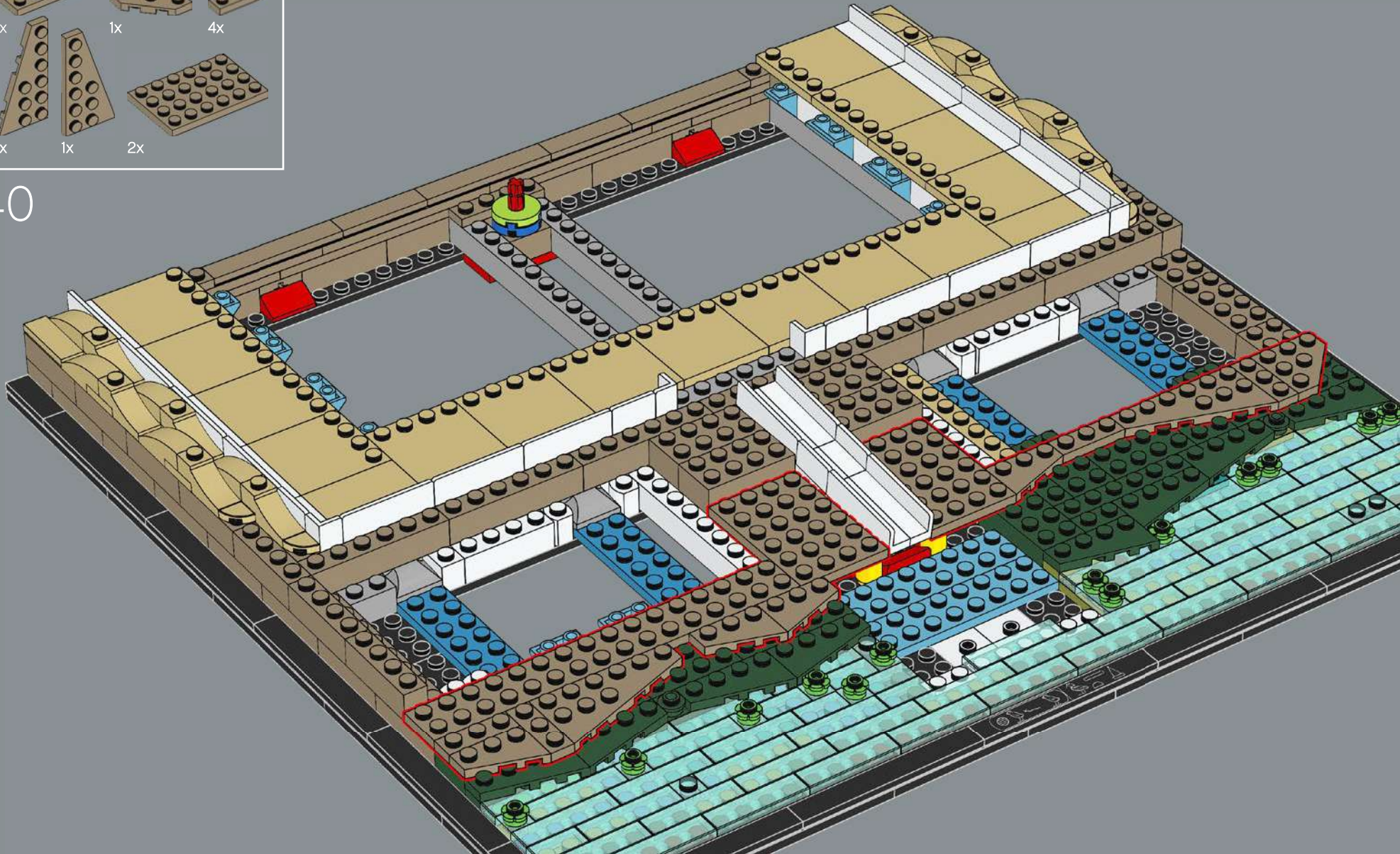

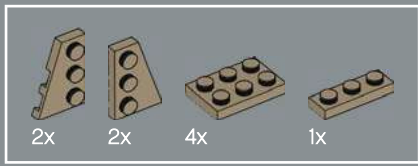

41

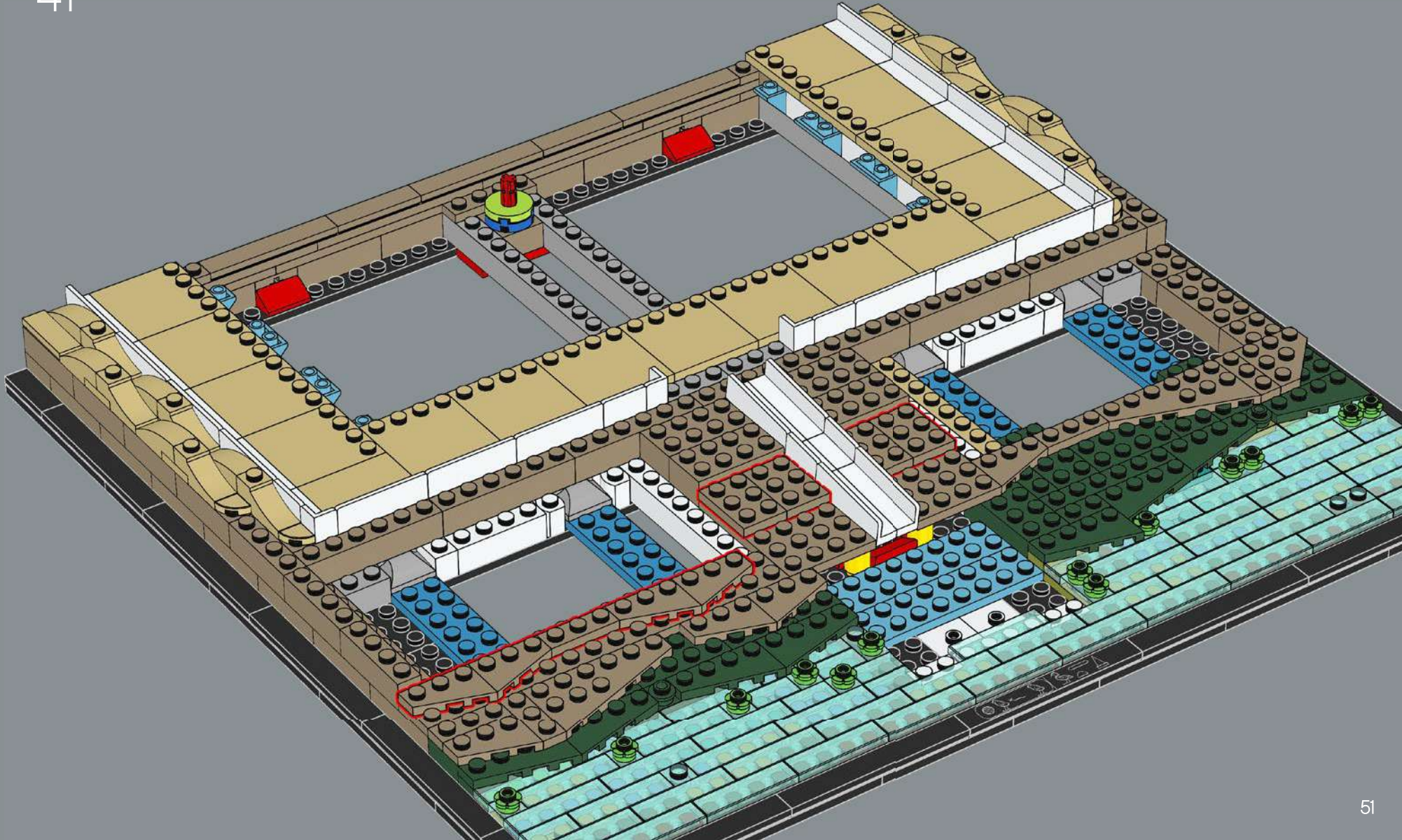

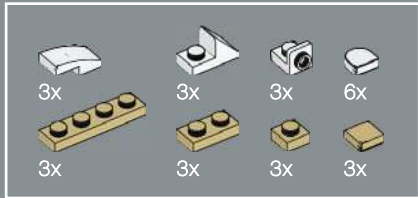

42

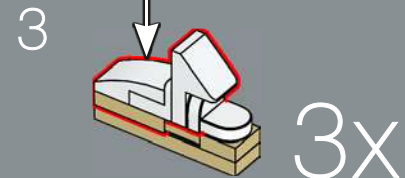
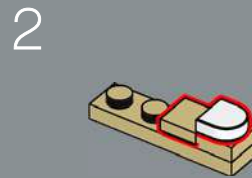
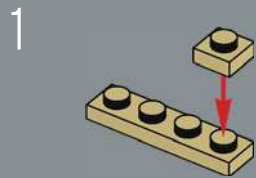
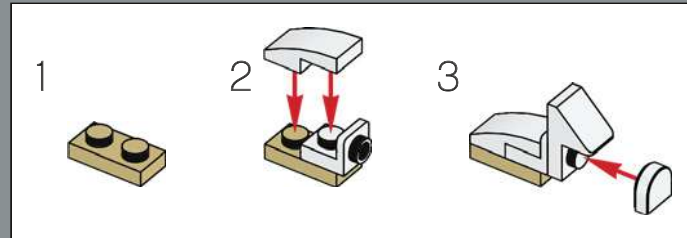

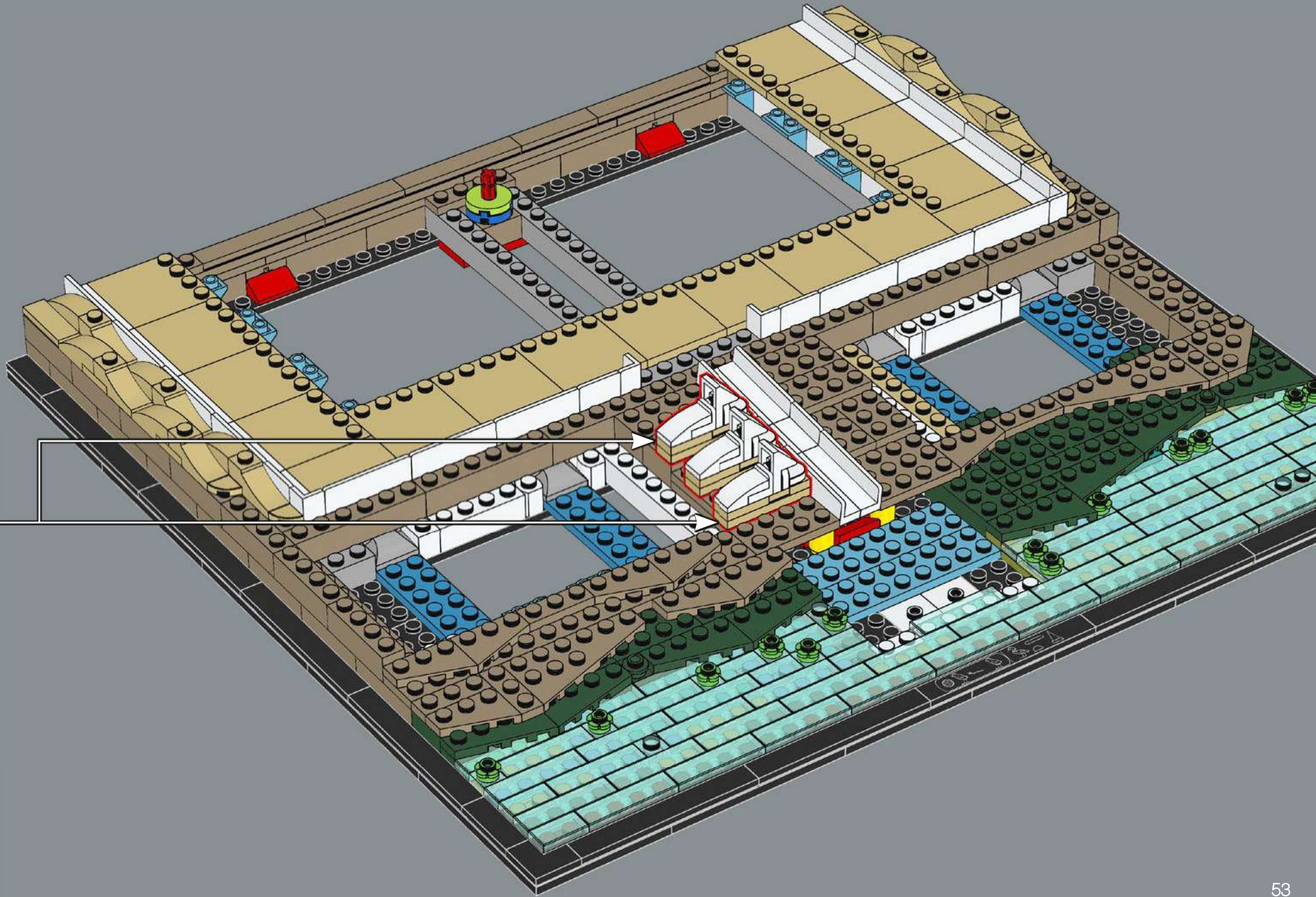

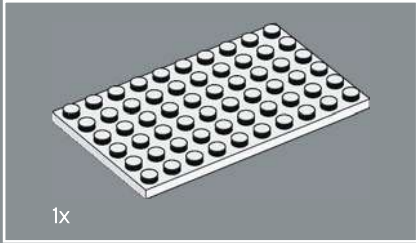

43

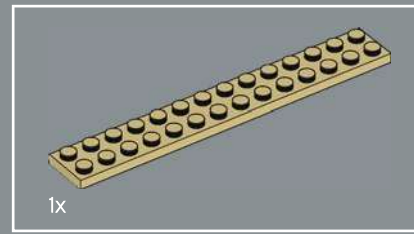
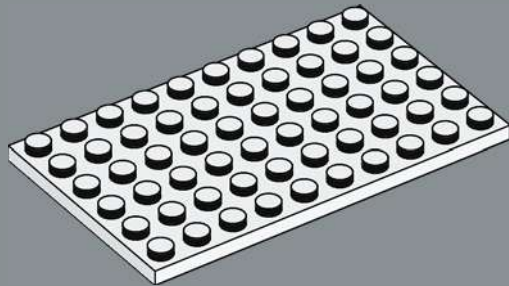

44

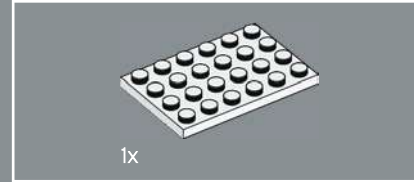
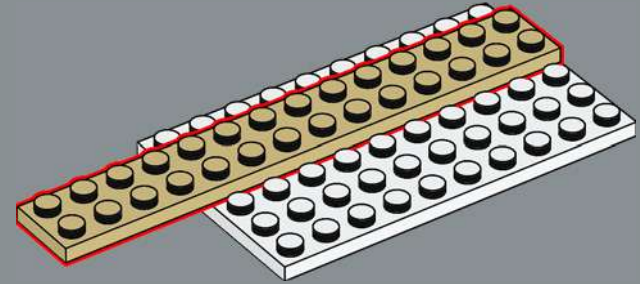

45

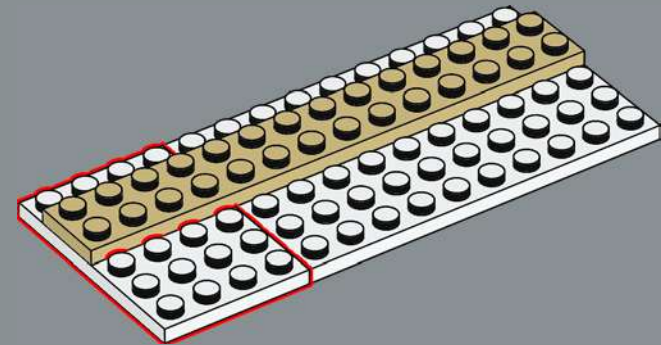

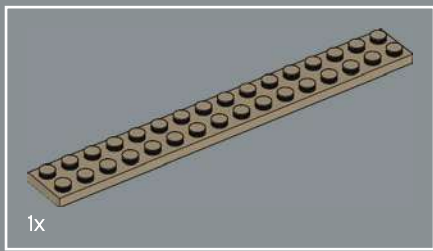

46

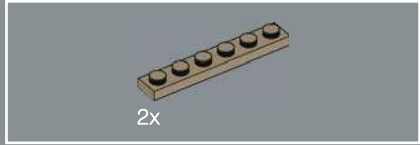
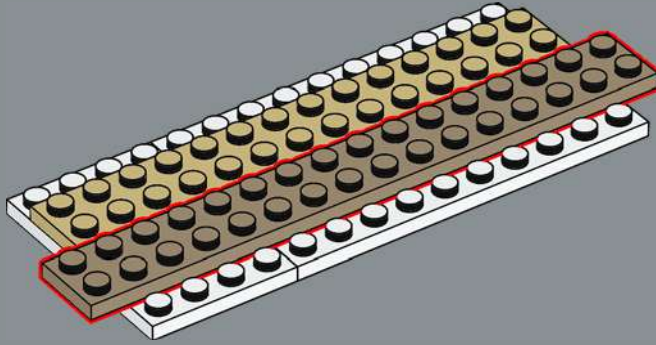

47

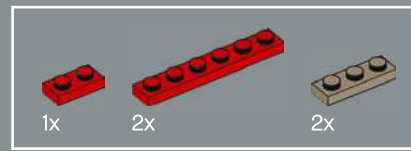
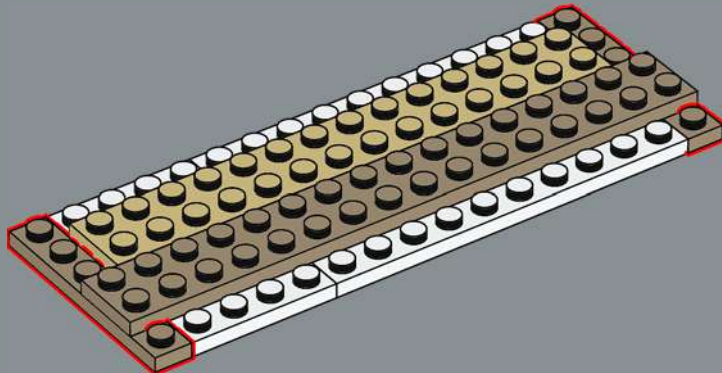

48

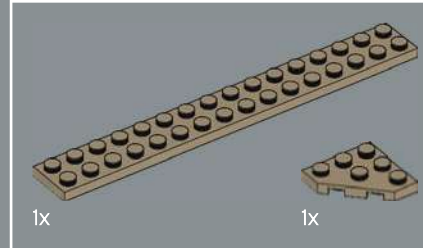
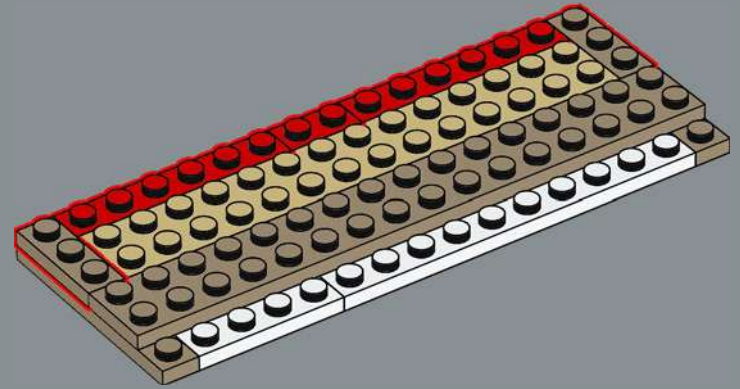

49

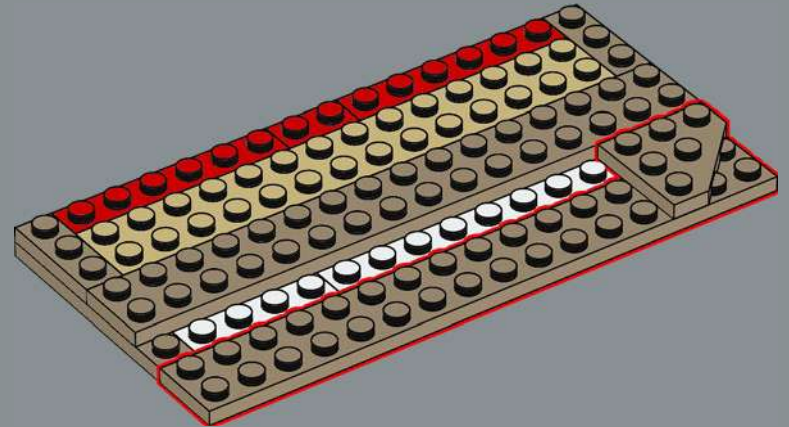

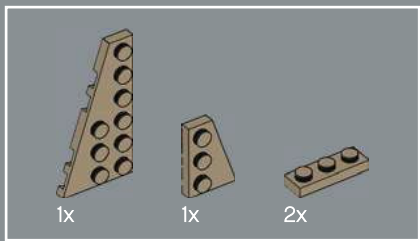

50

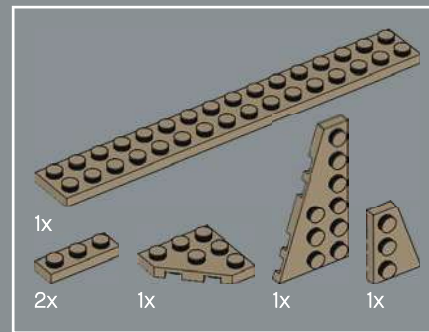
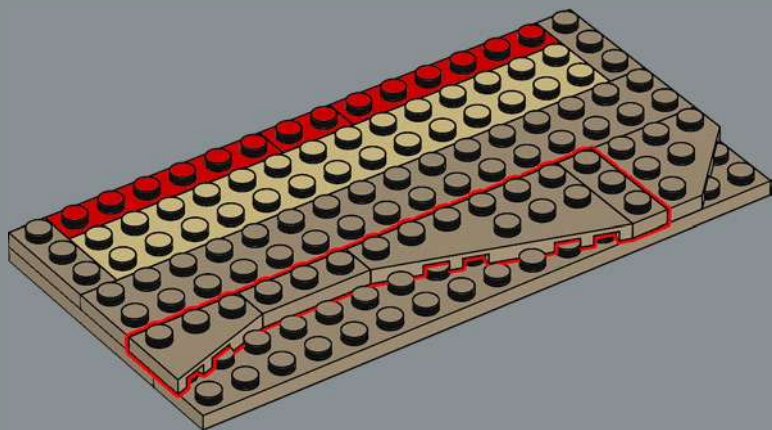

51

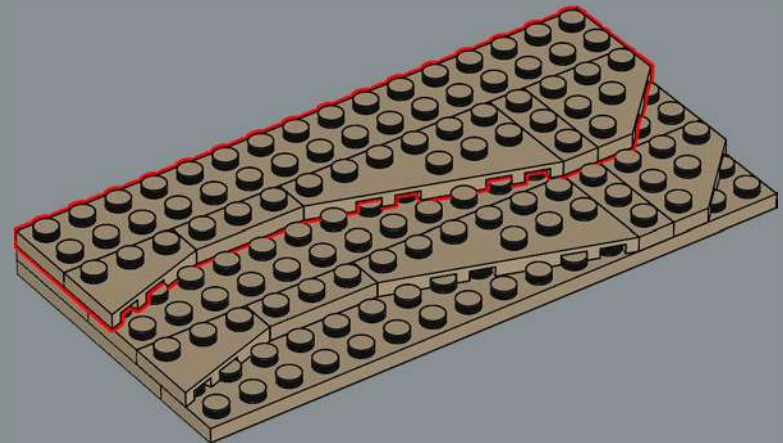

52

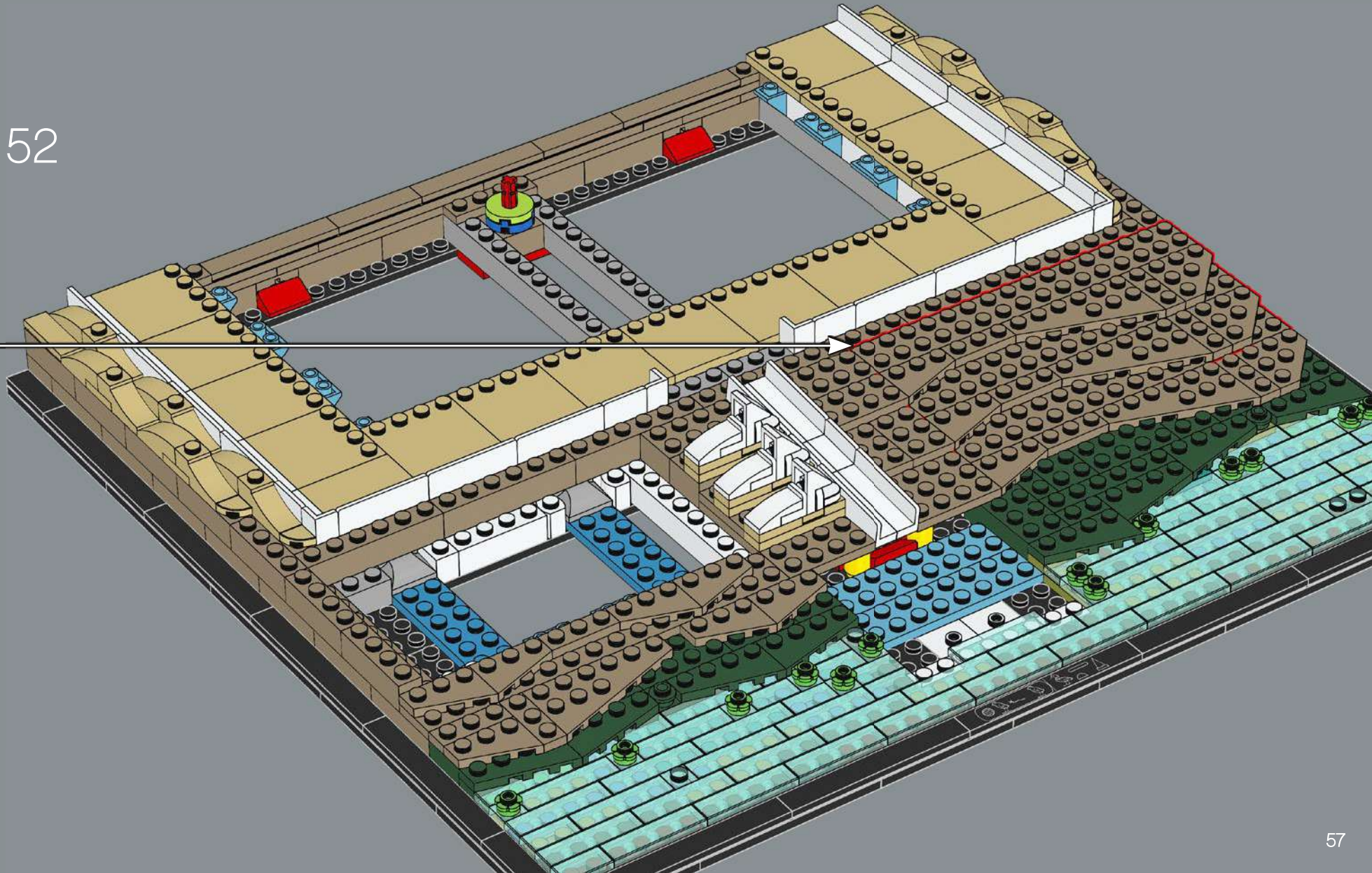

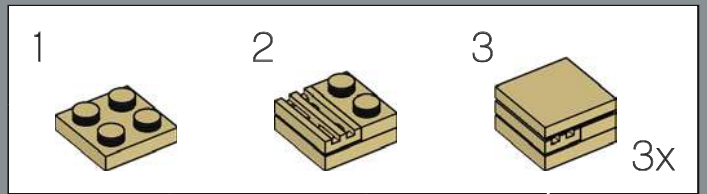
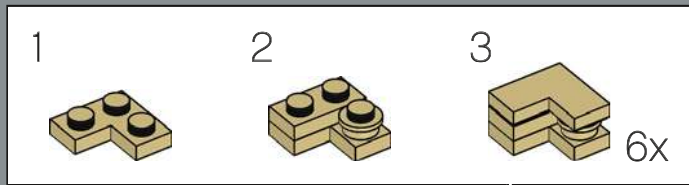
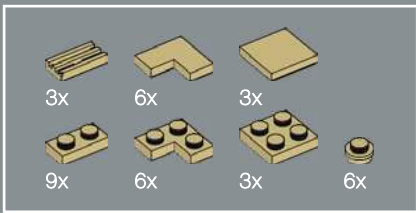

53

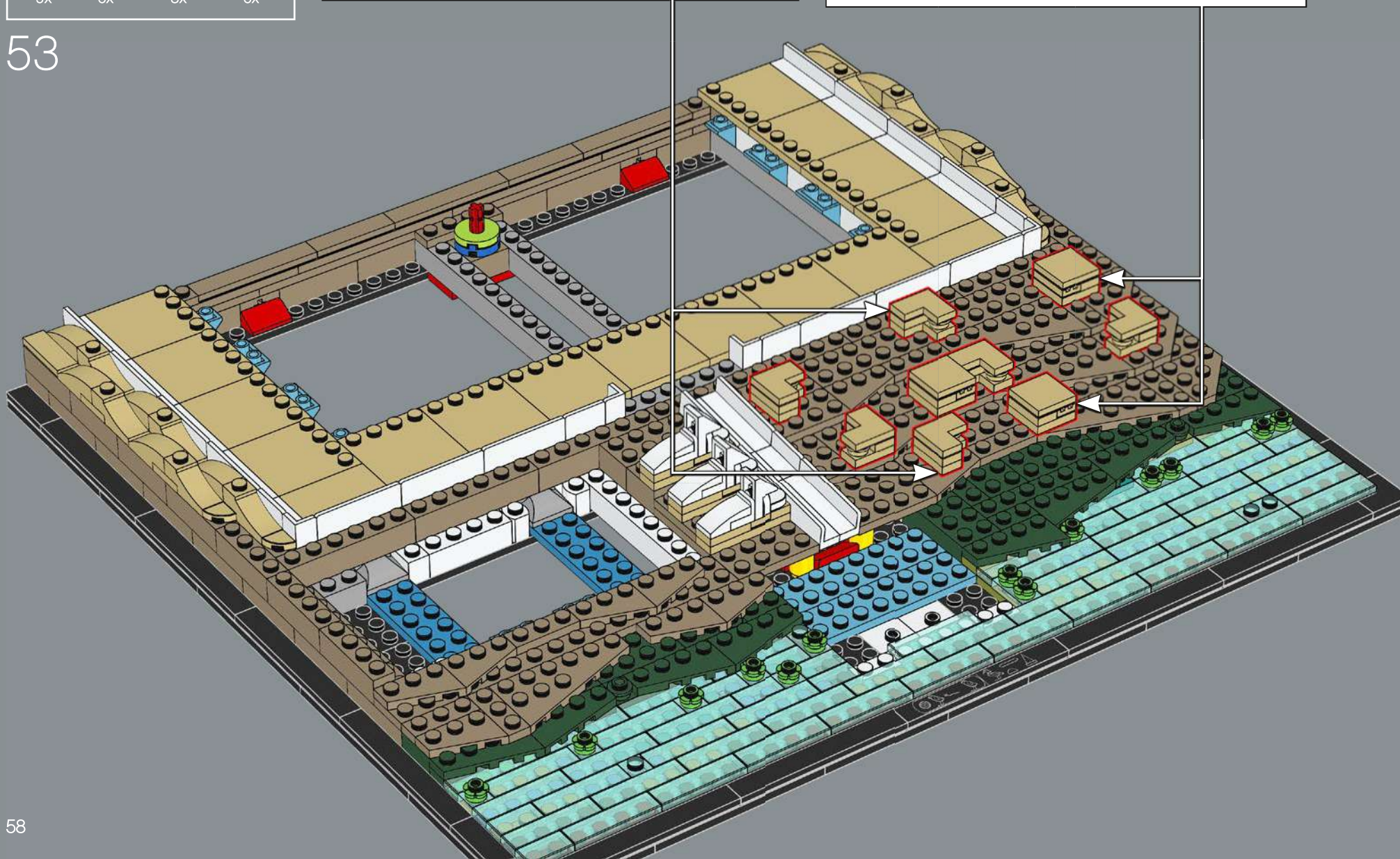

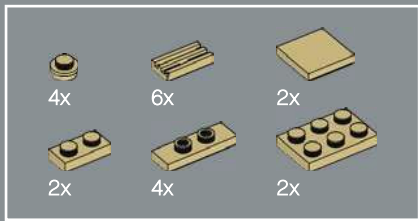

54

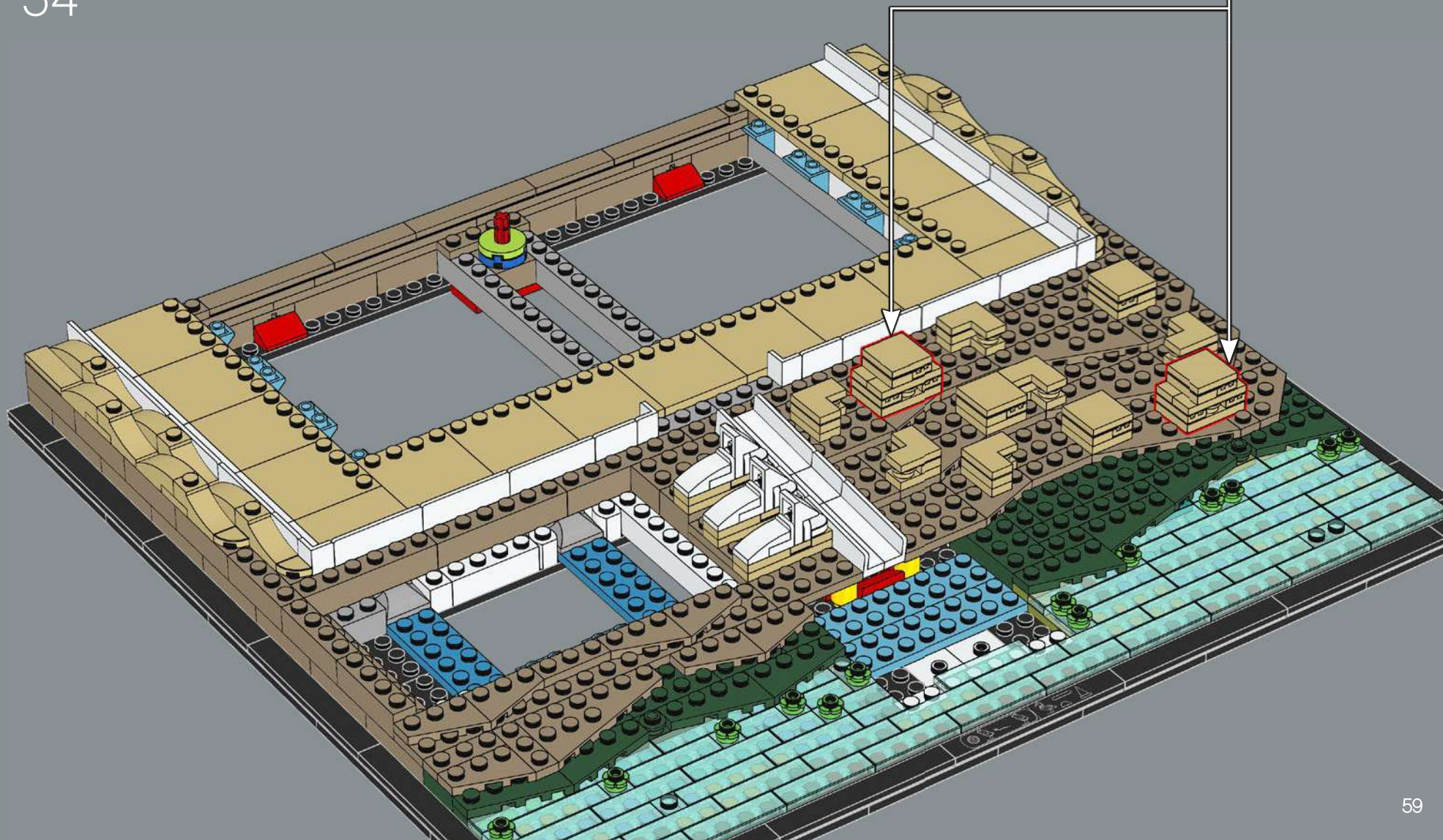

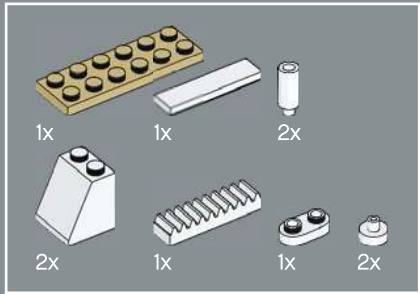

55

1

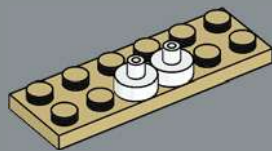

2

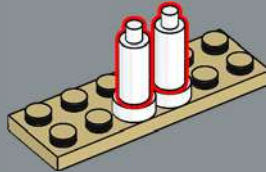

3

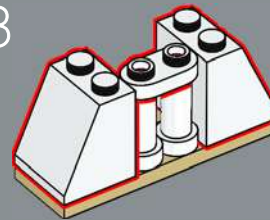

4

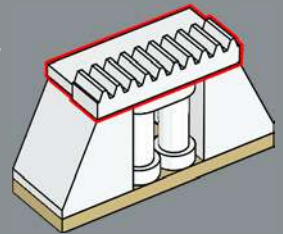

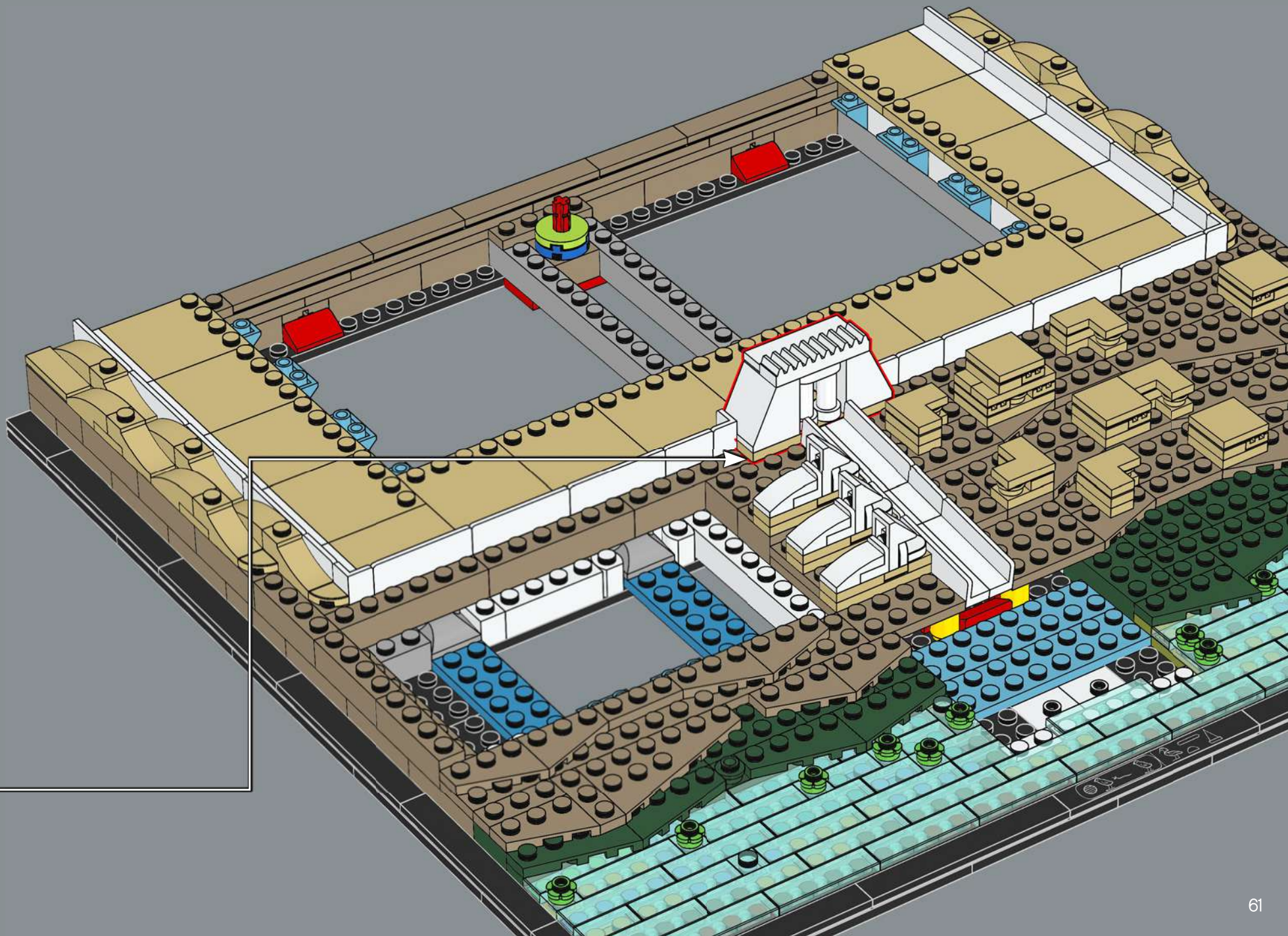

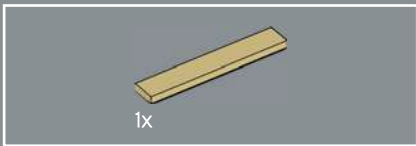
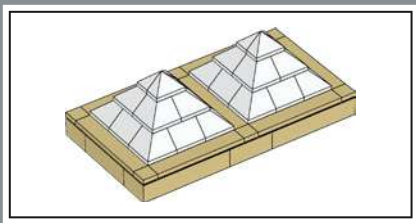

56

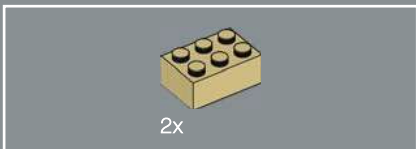
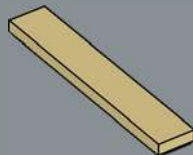

57

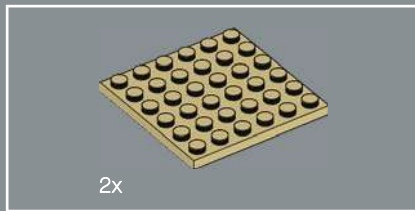
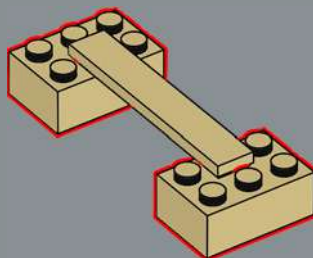

58

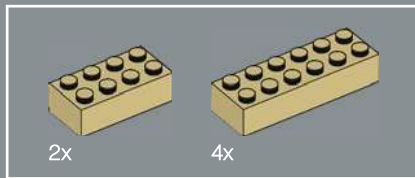
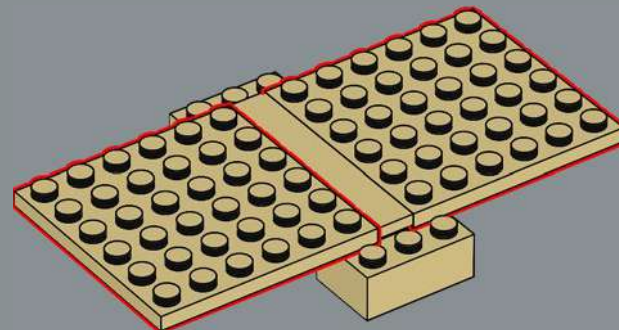

59

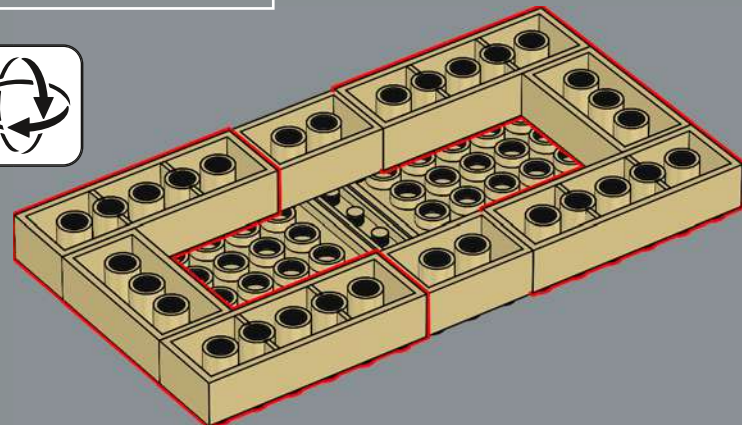

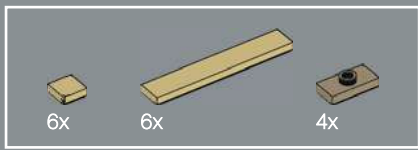

60

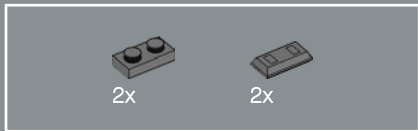
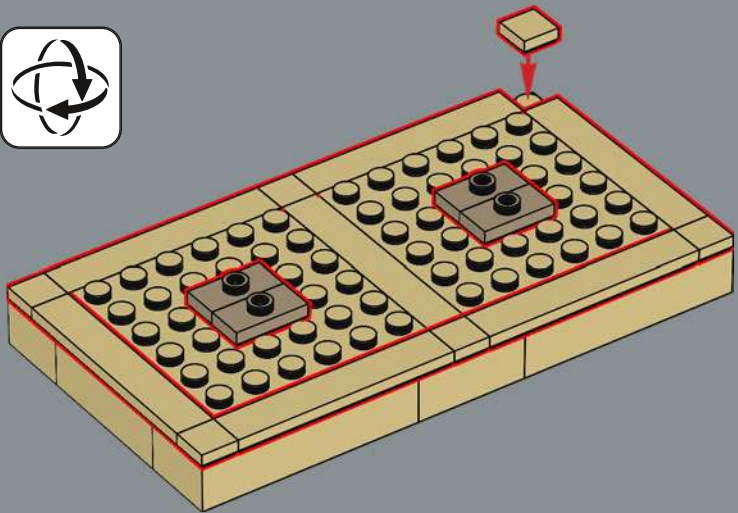

61

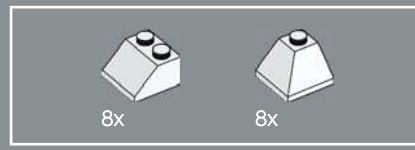
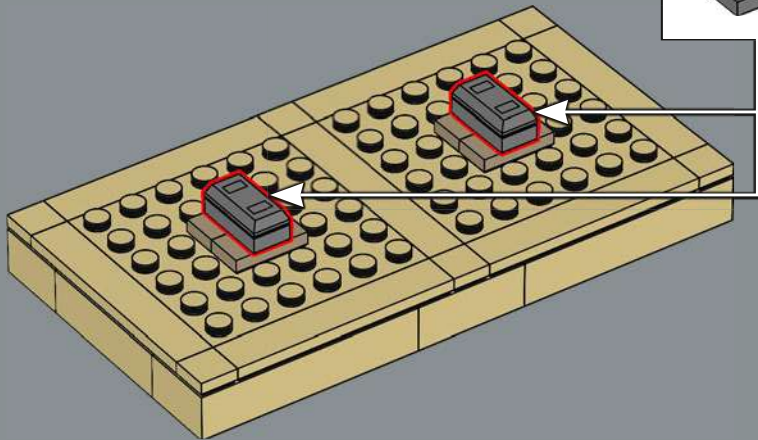
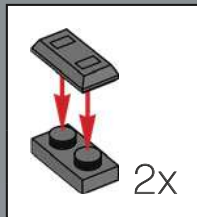

62

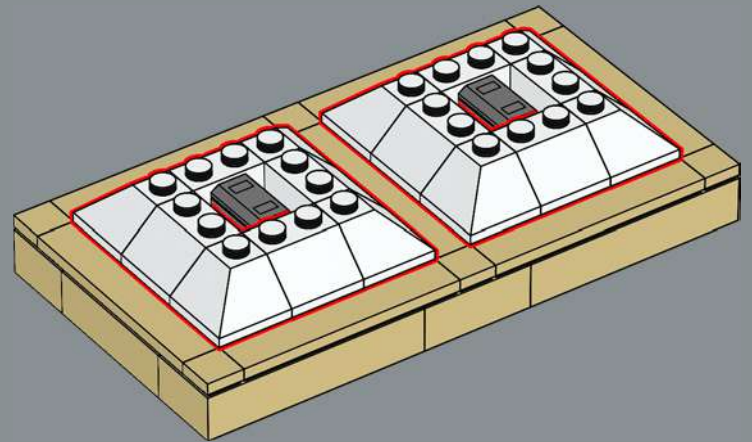



63

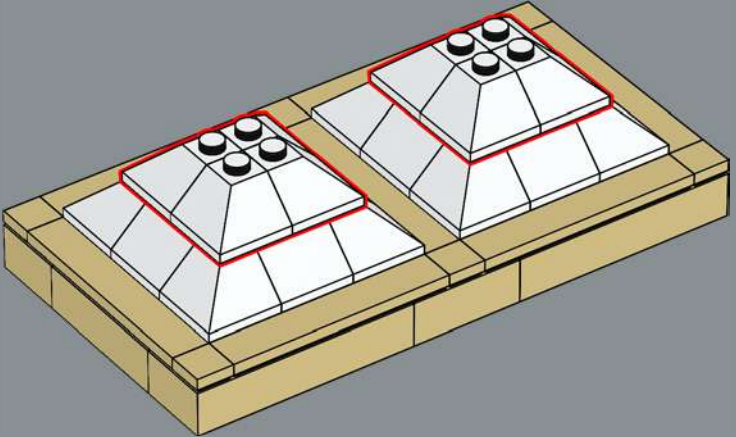

64

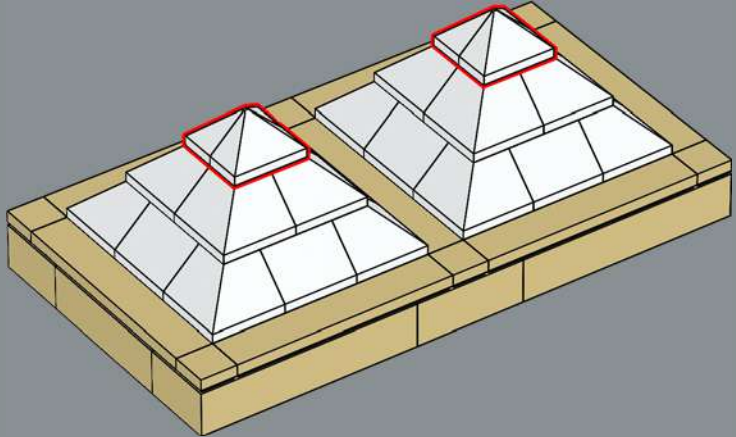

65

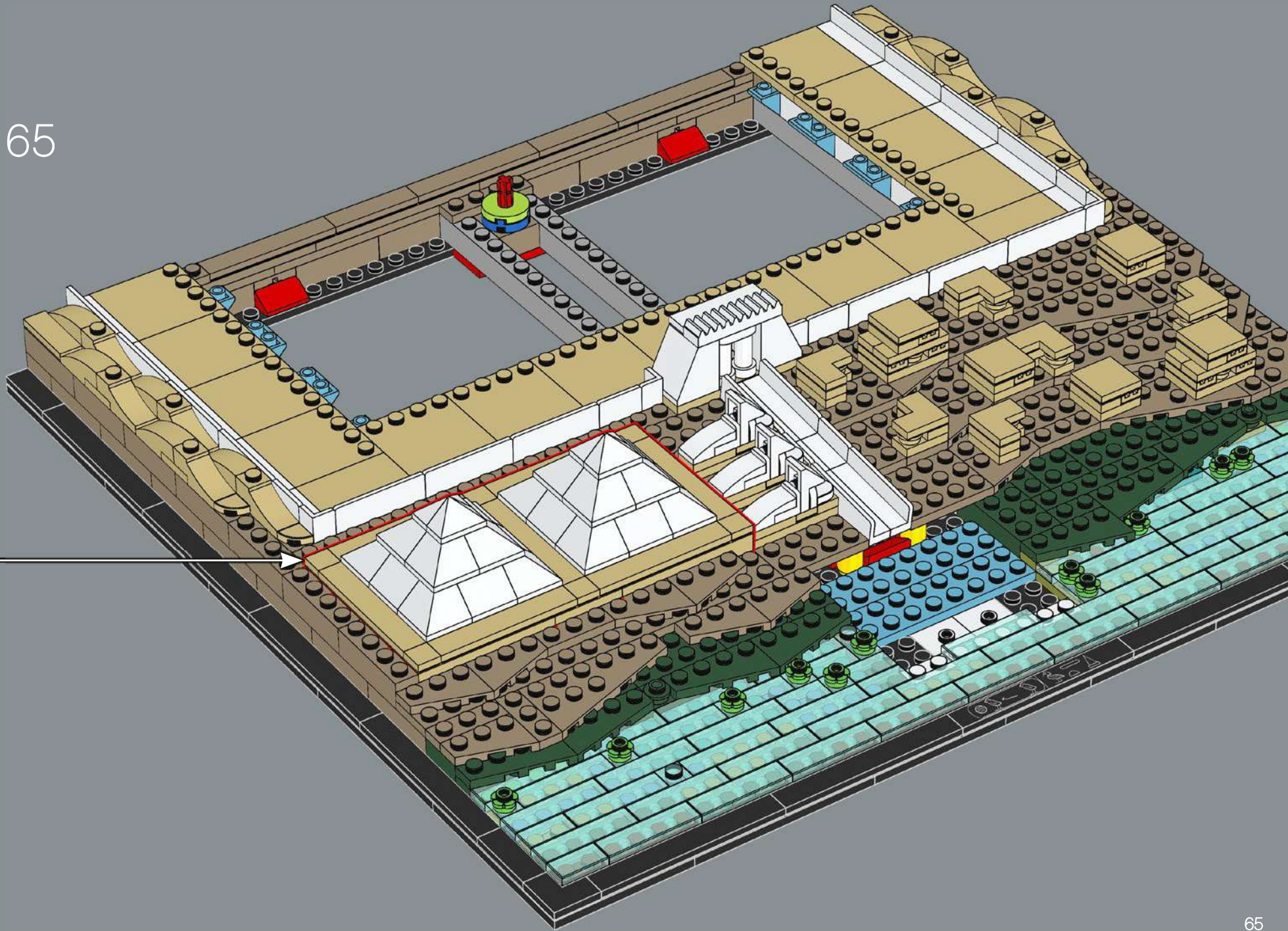

		
17x	6x	20x

66

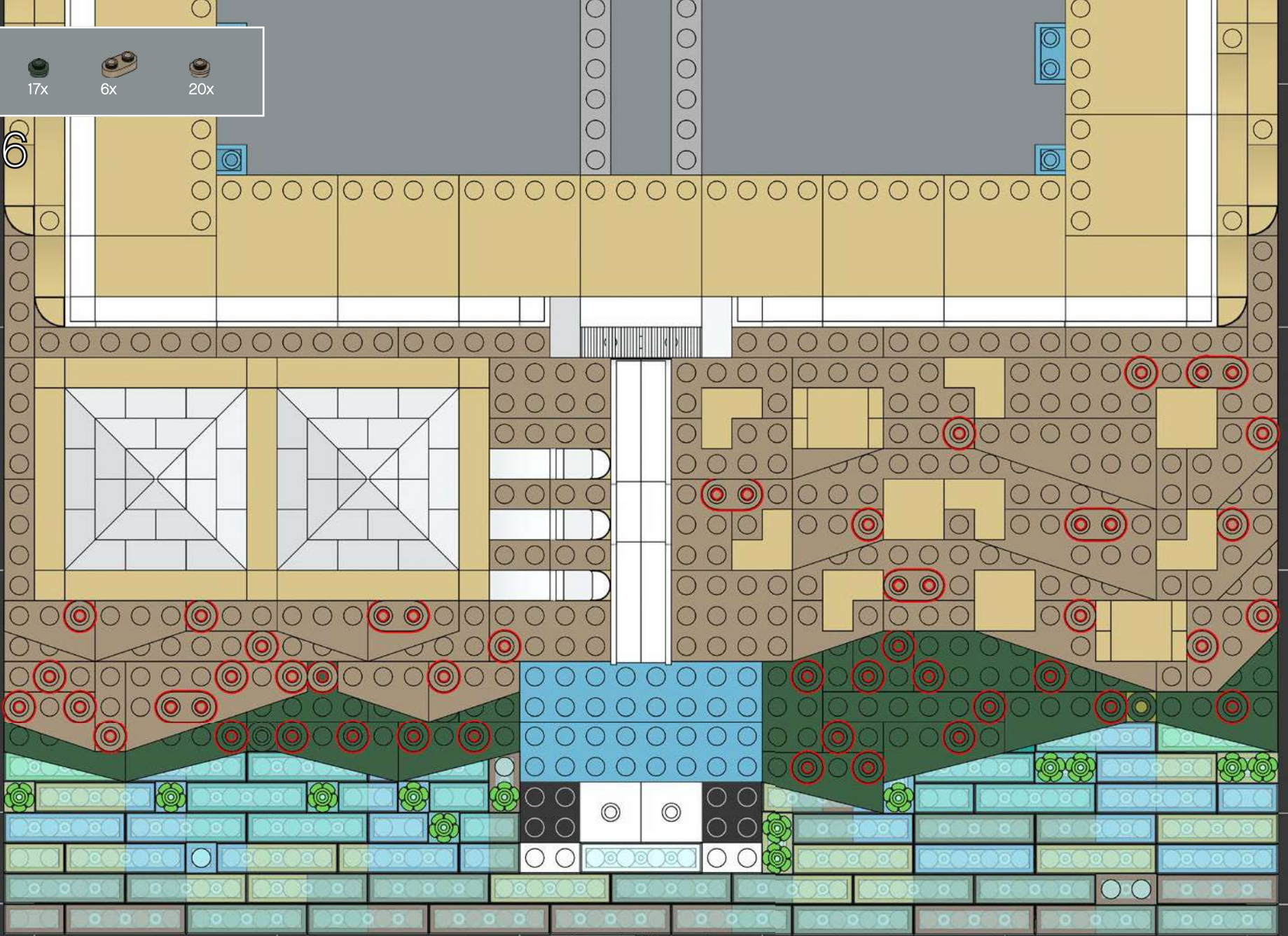



29x



16x

67





68

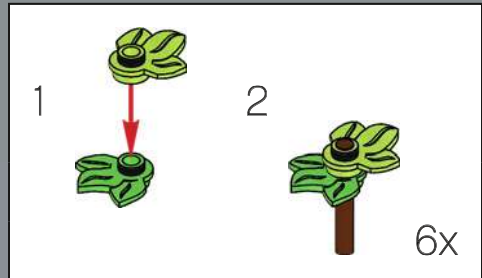

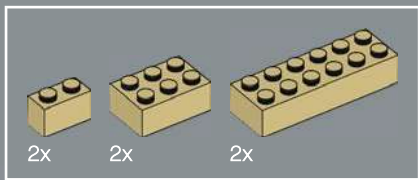

69

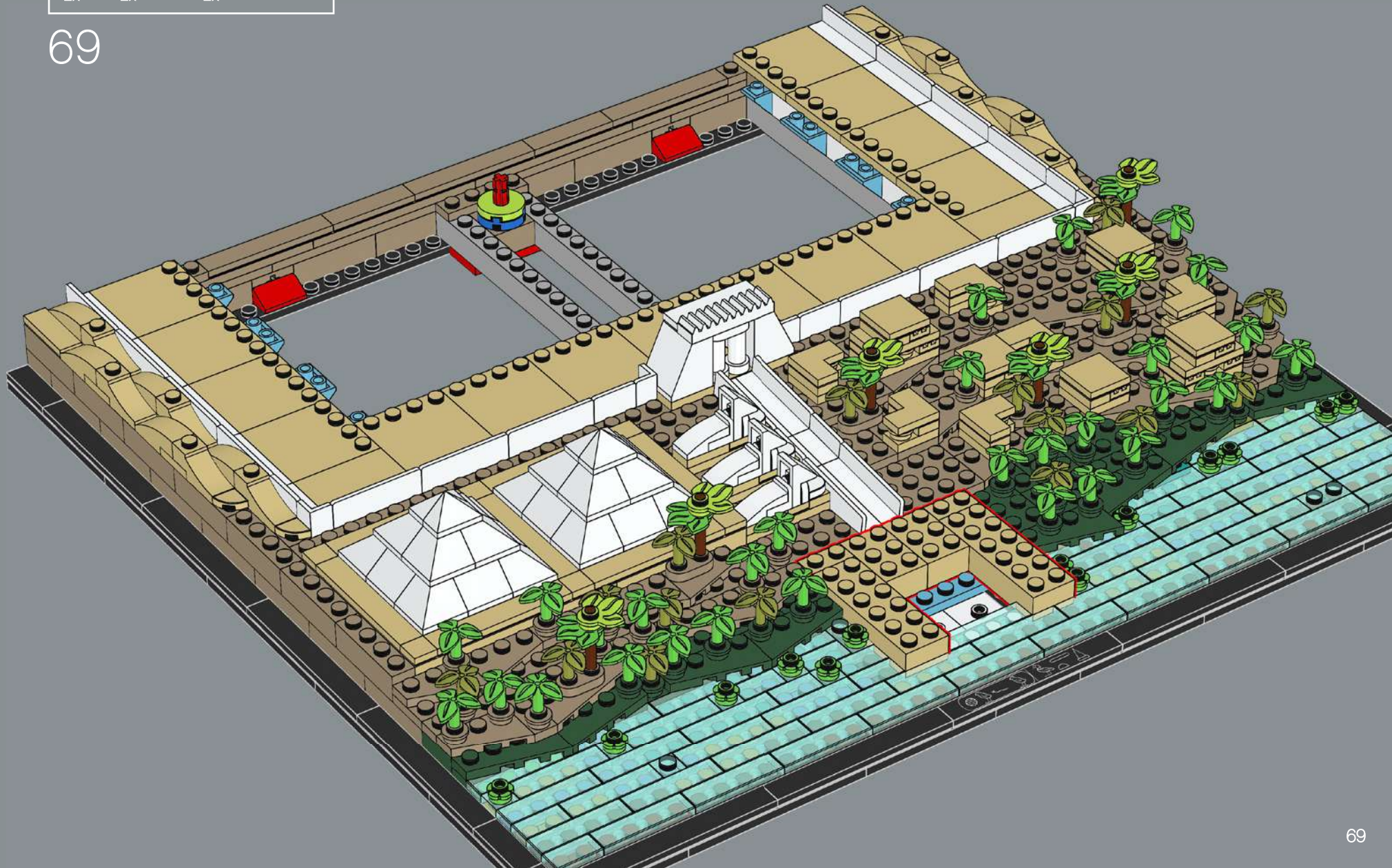

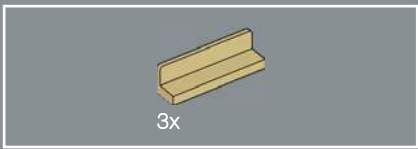

70

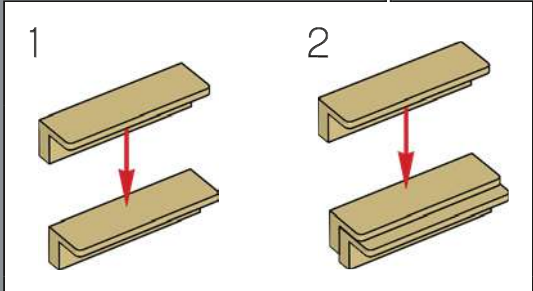
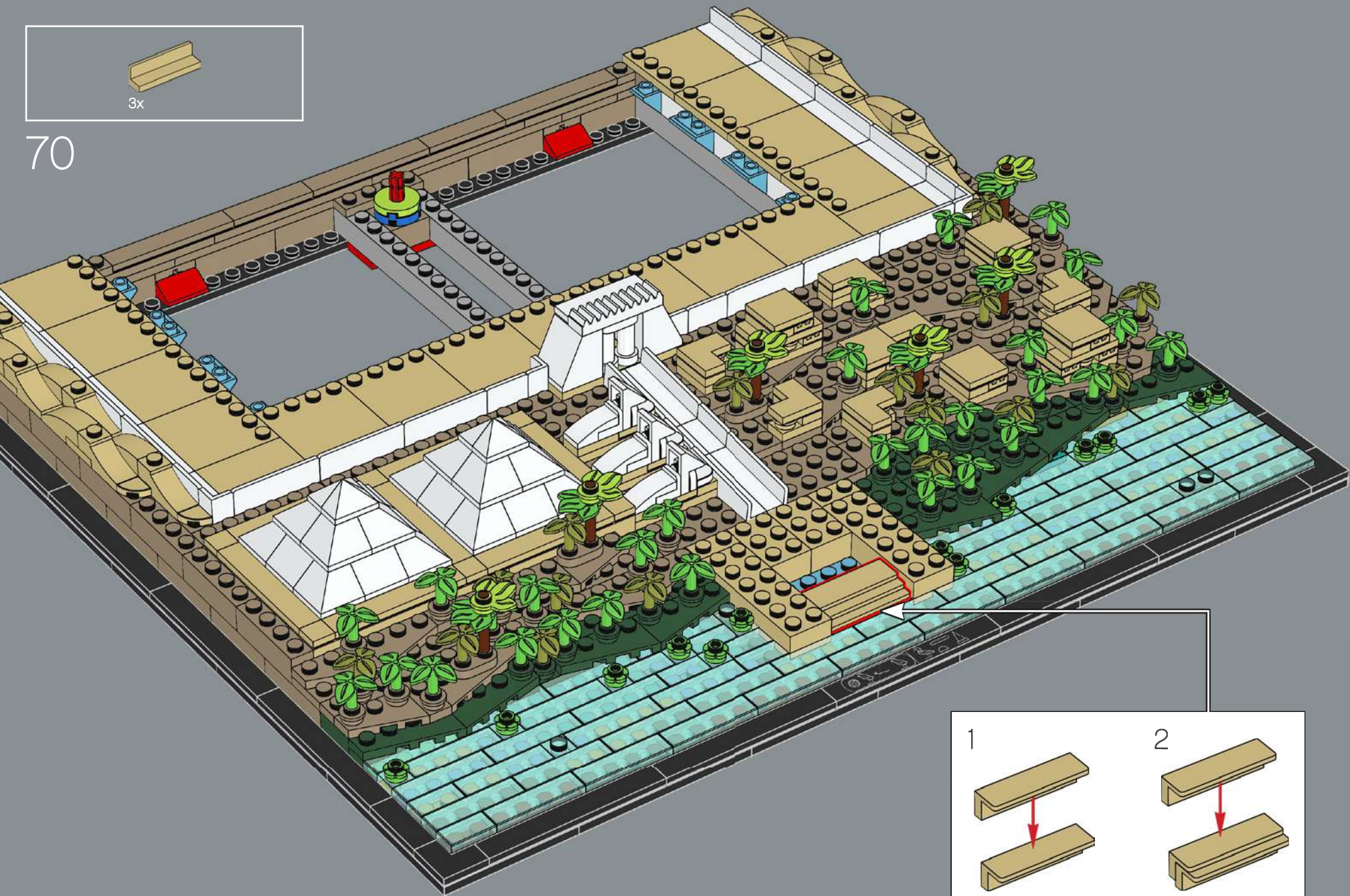

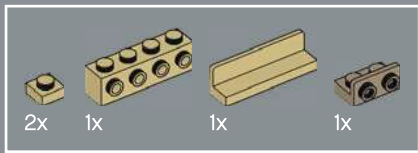

71

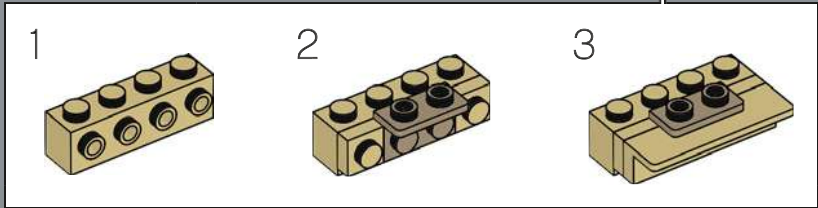
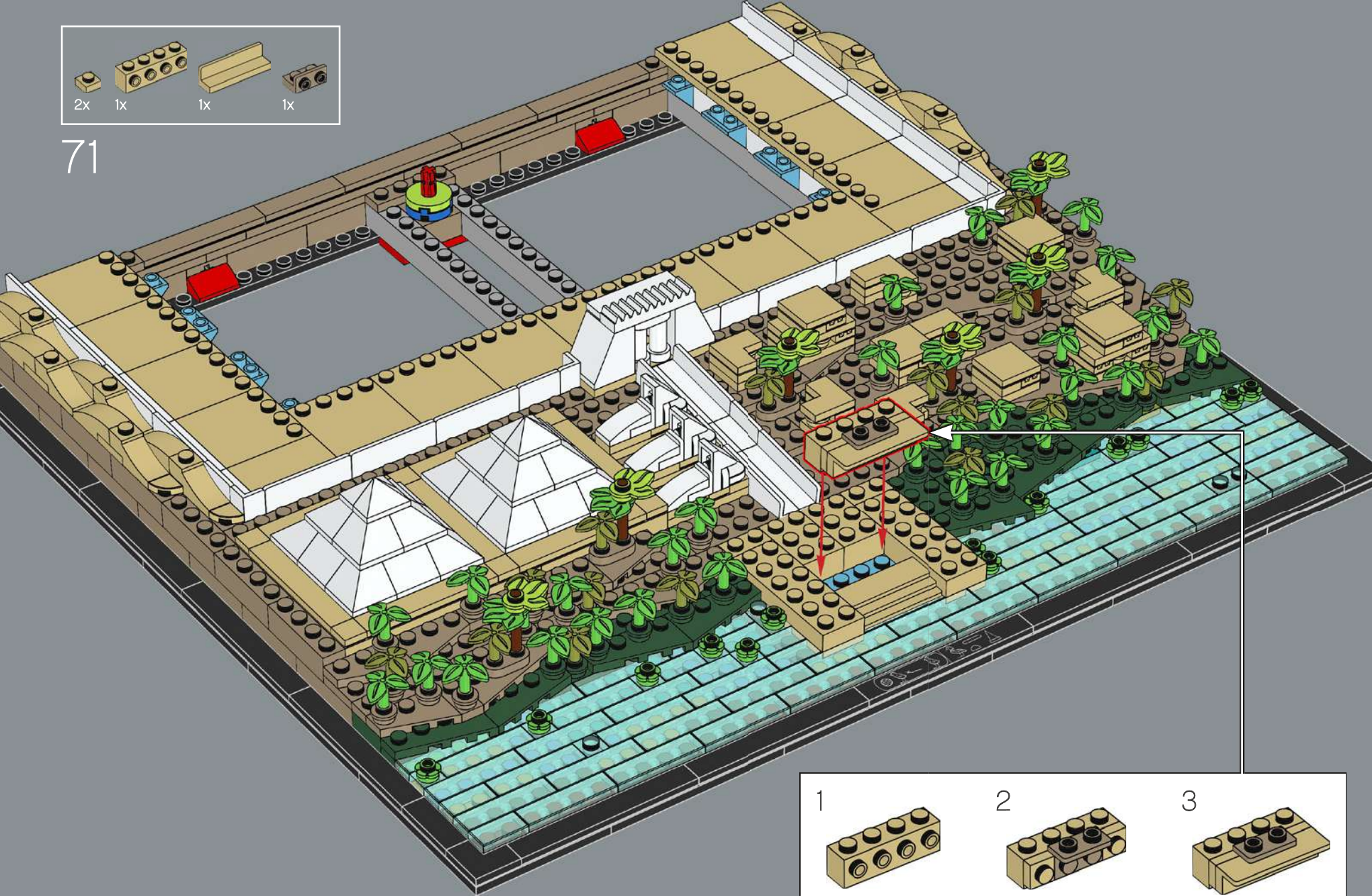

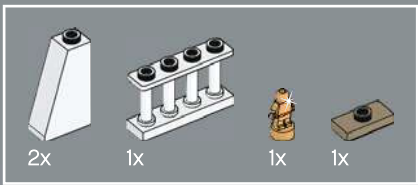

72

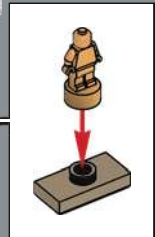

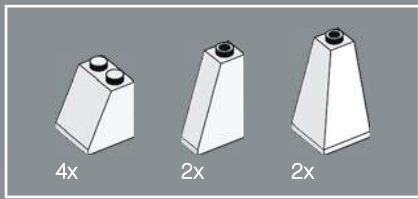

73





74

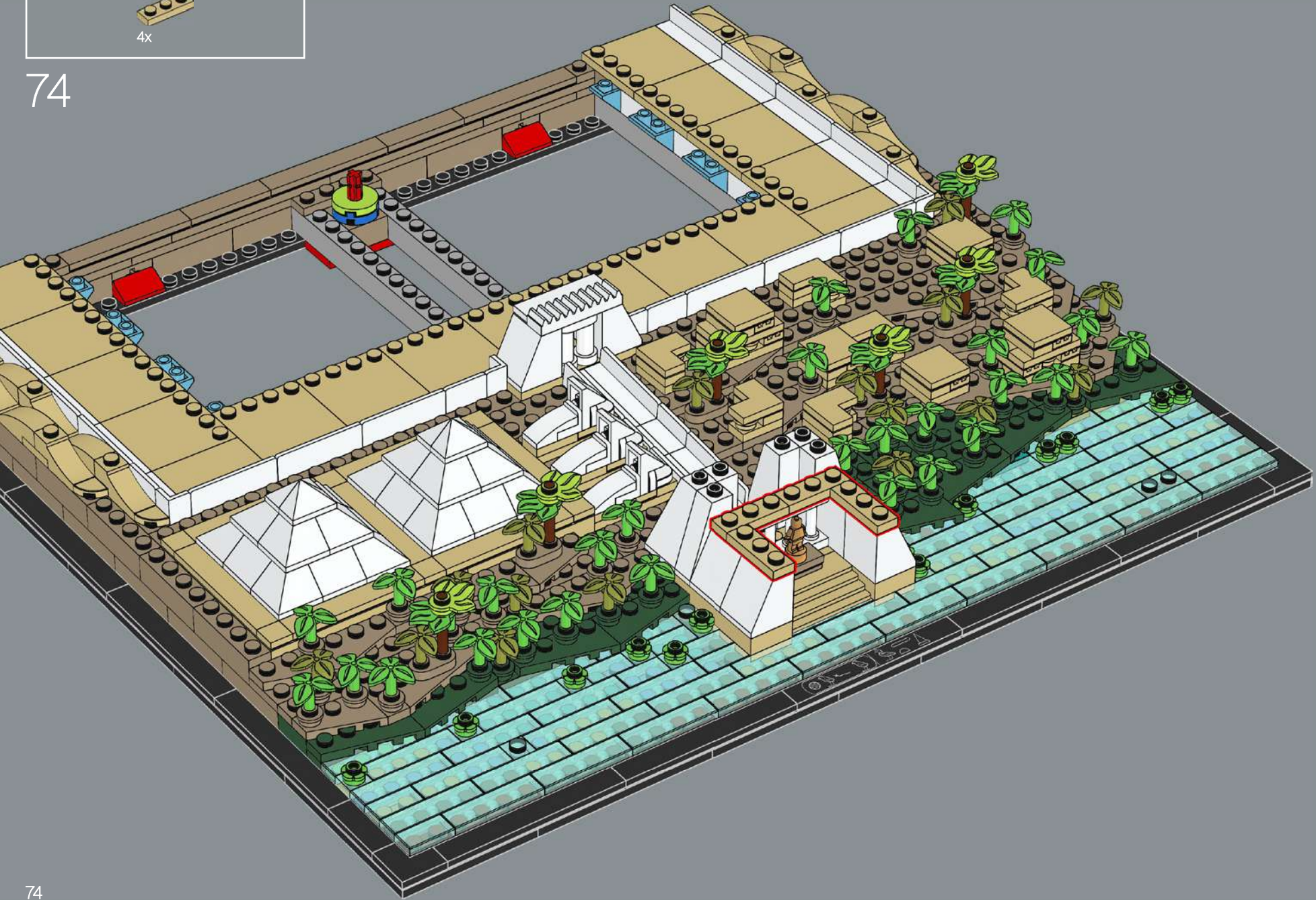

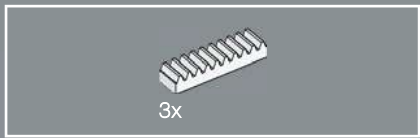

75



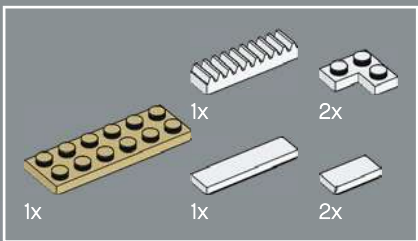

76

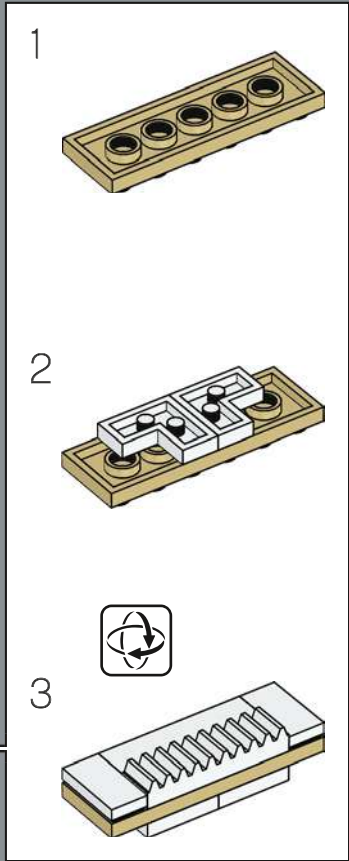

76

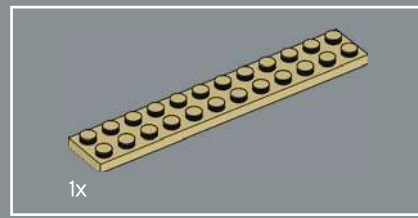

77

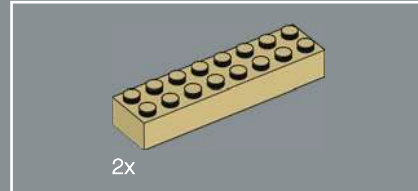
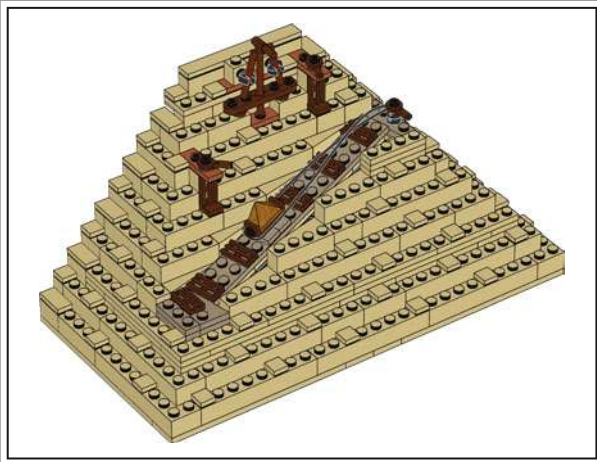
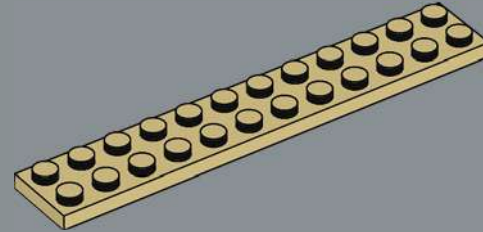

78

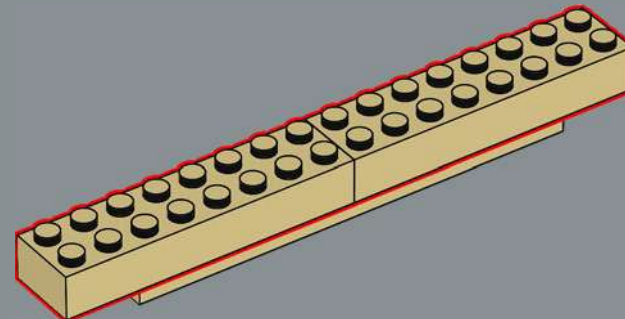

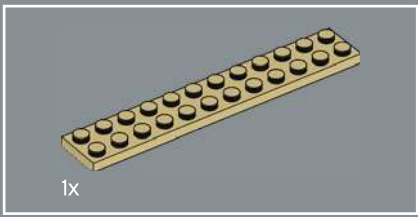

79

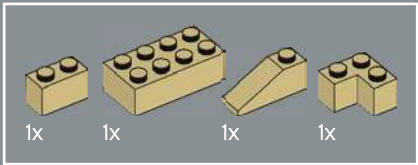
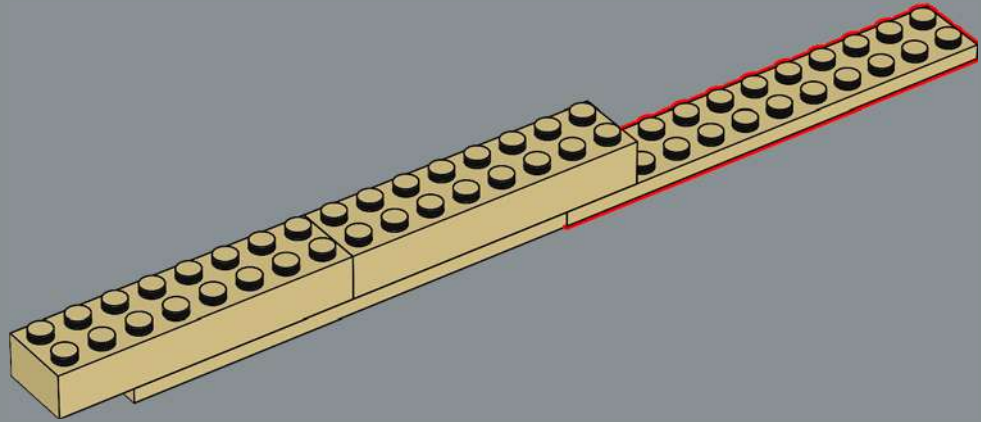

80

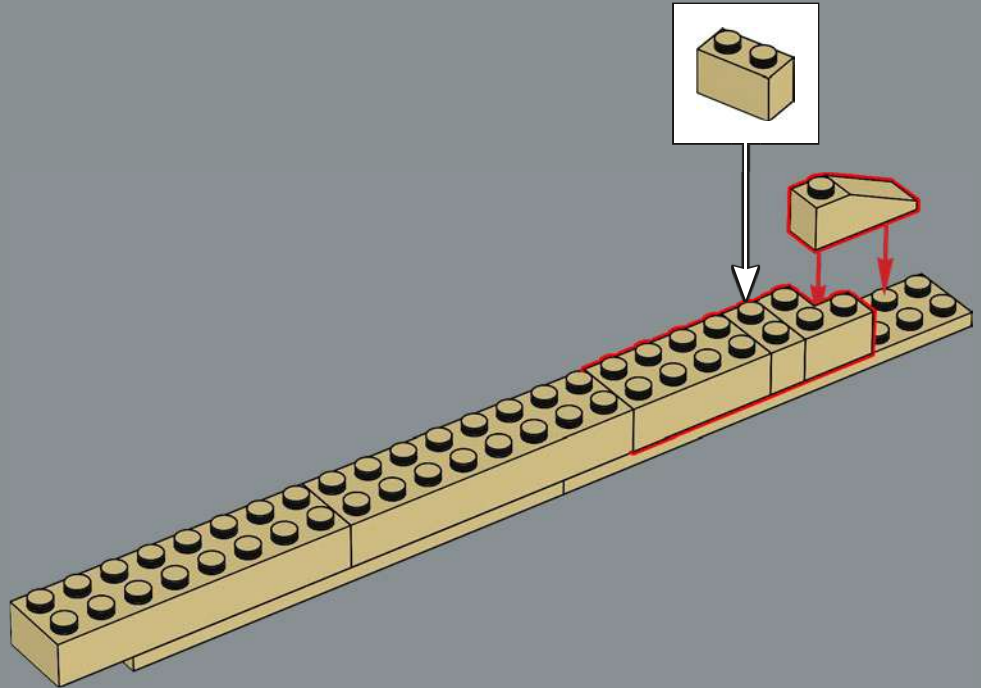

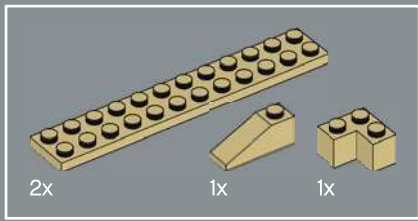

81

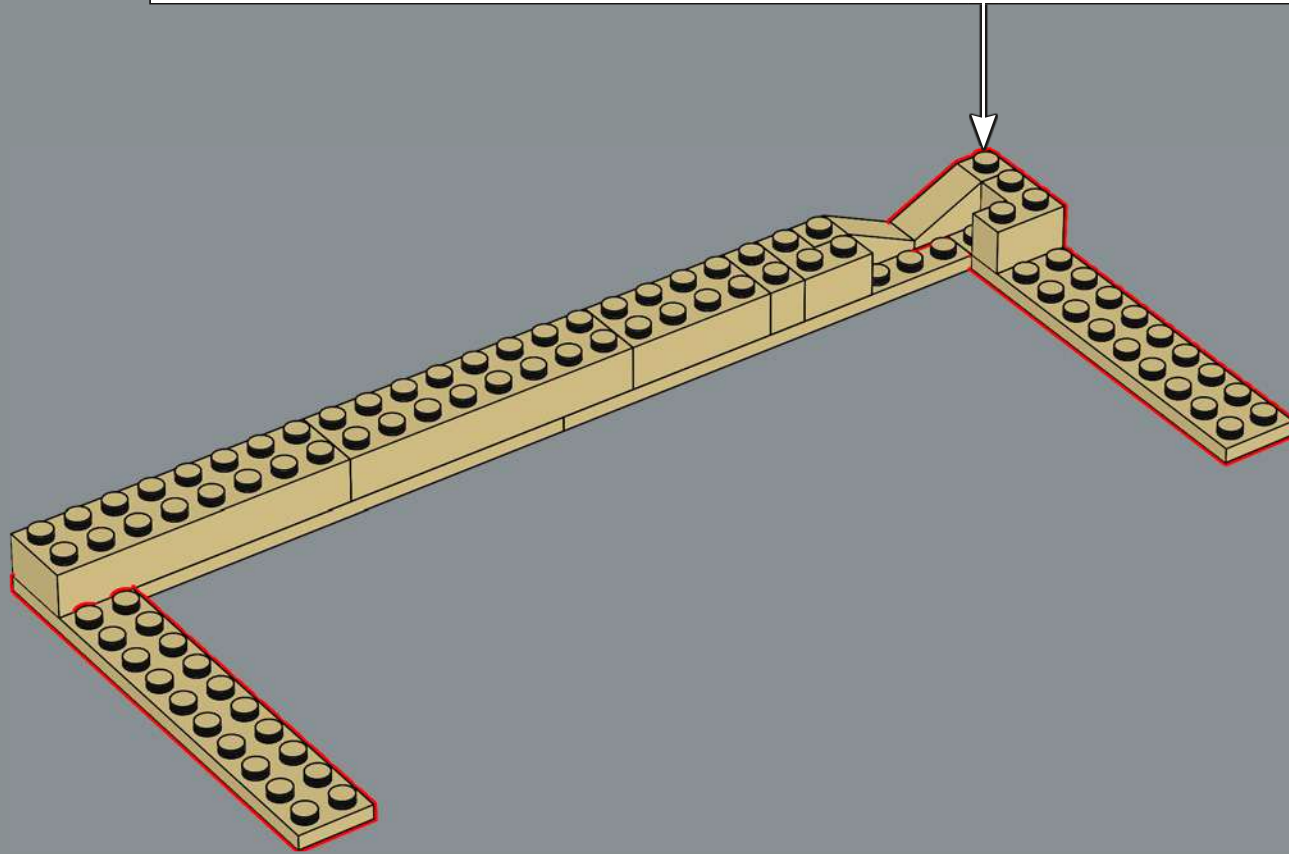
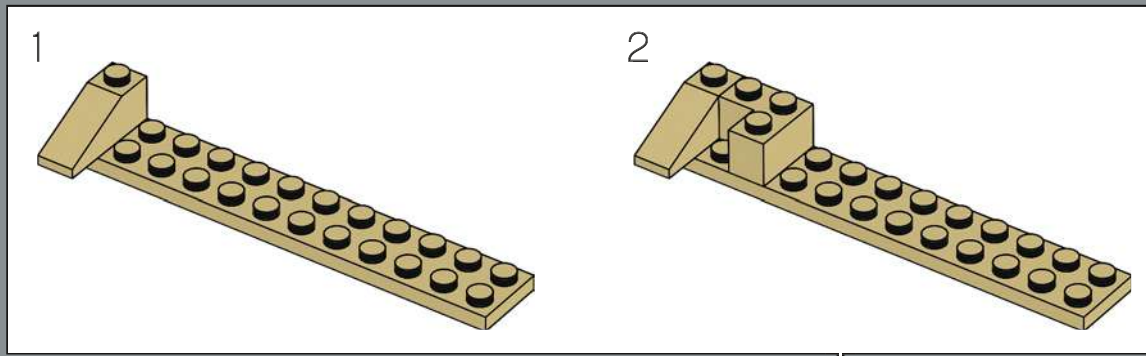



82

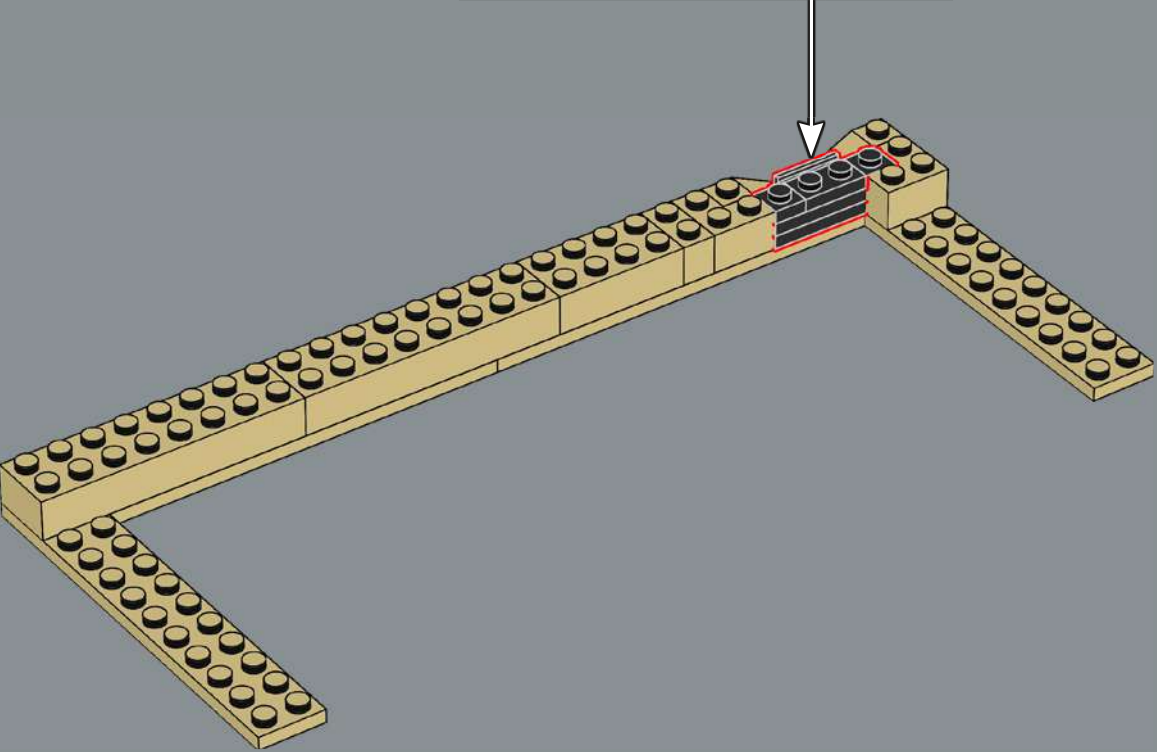
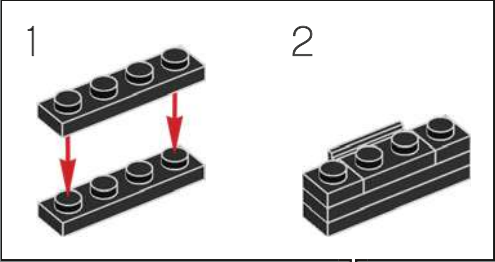

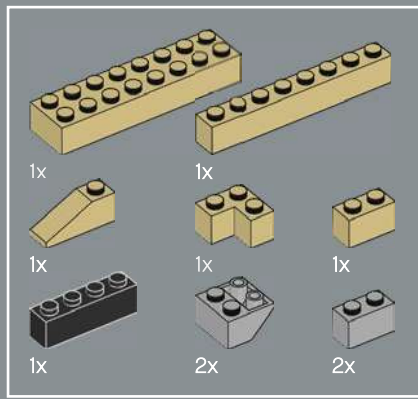

83

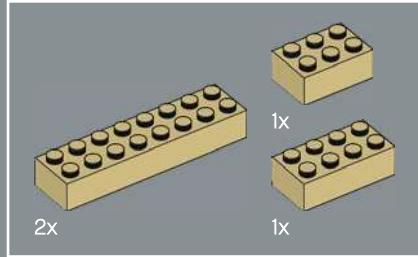
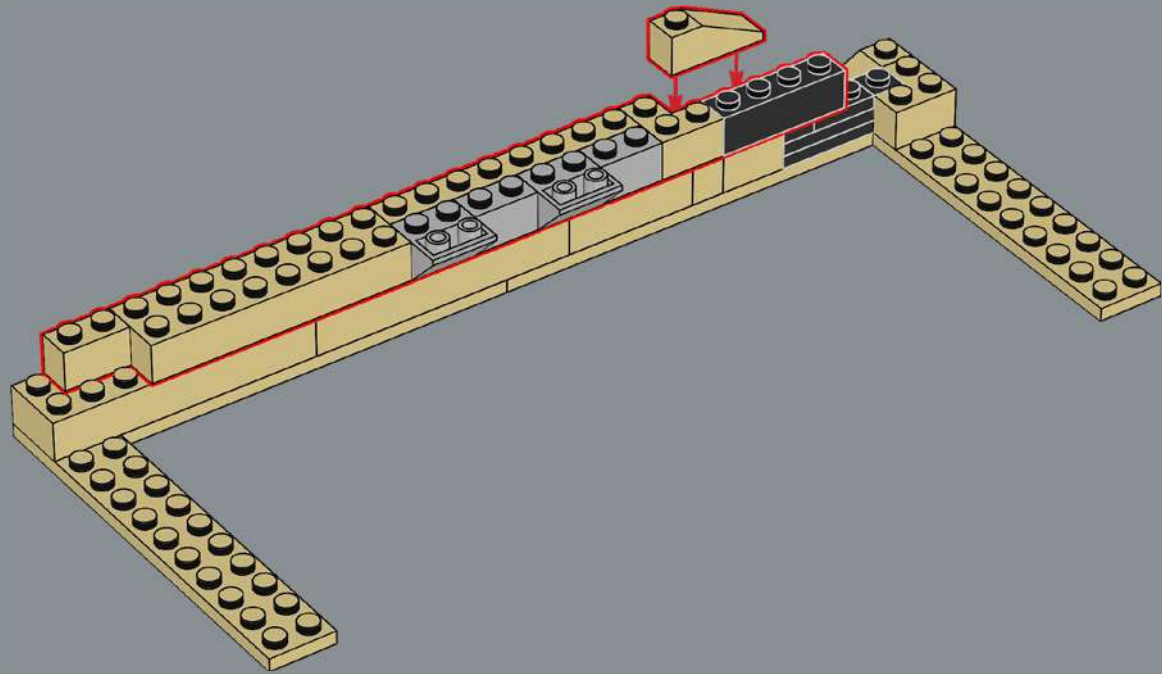

84

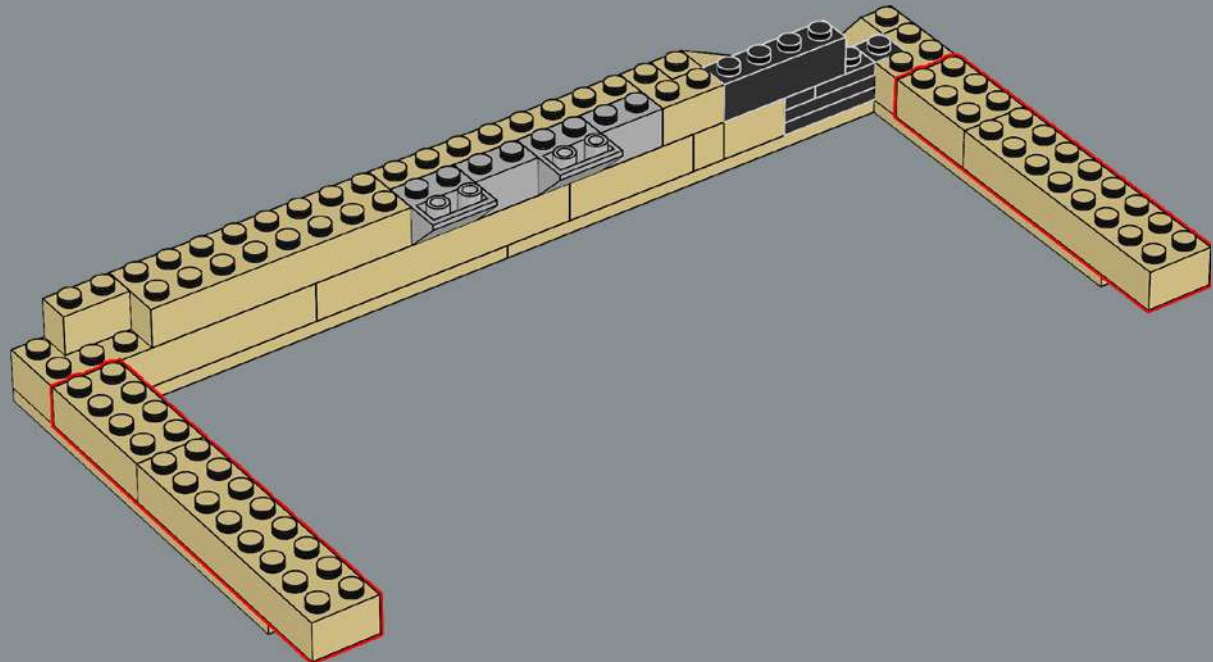

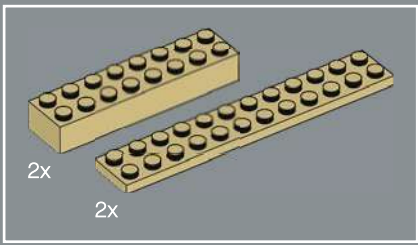

85

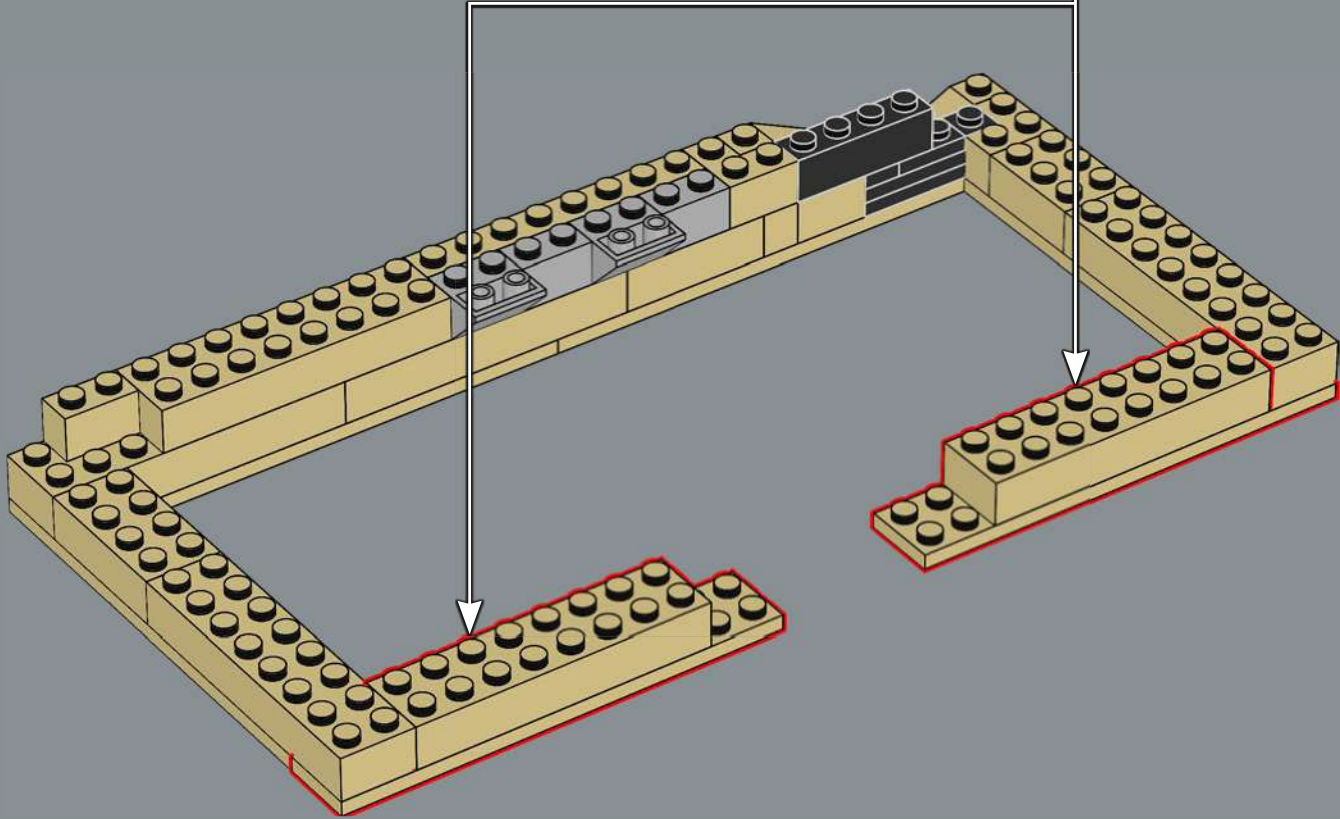
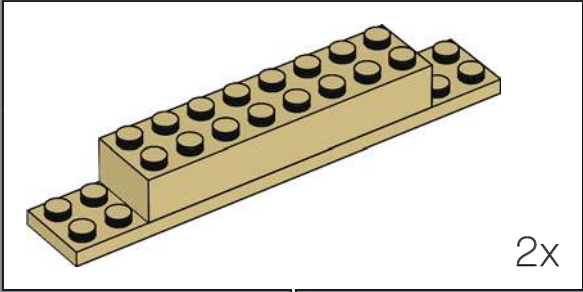

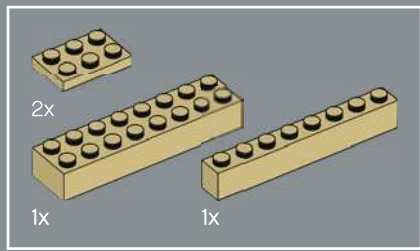

86

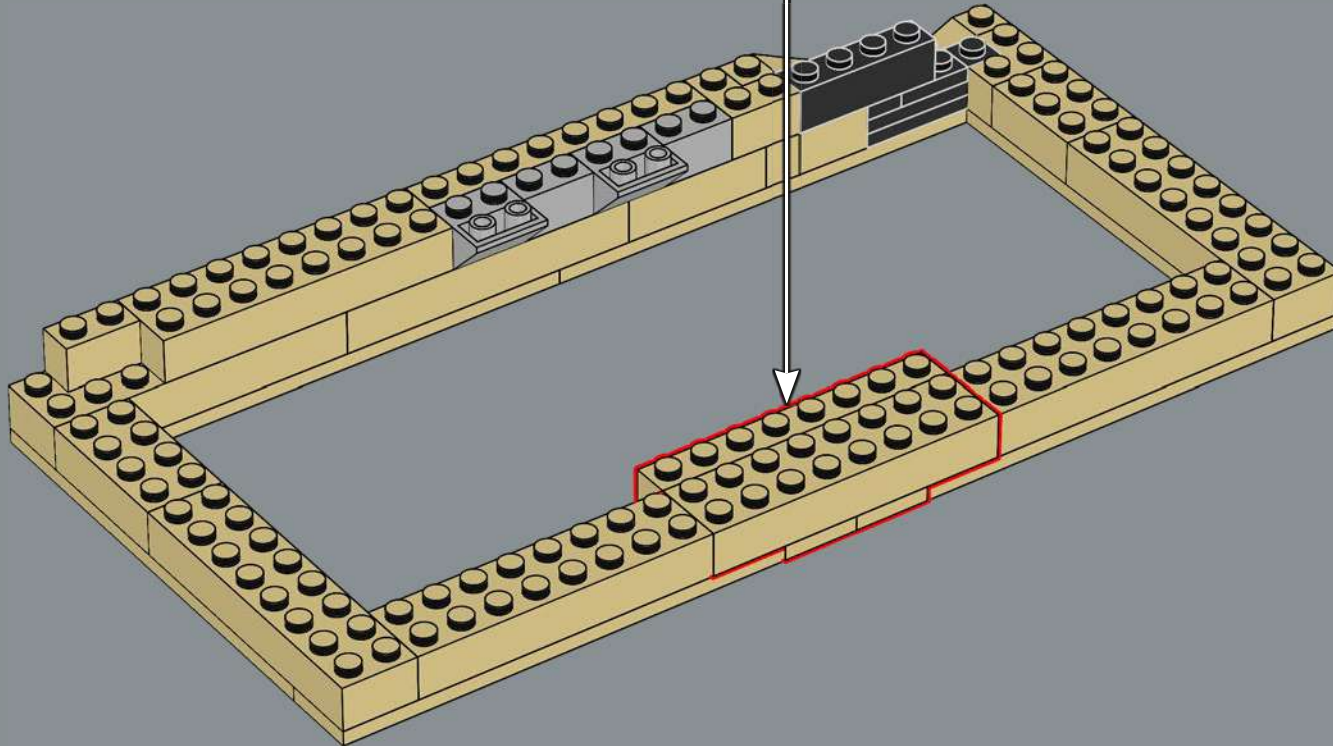
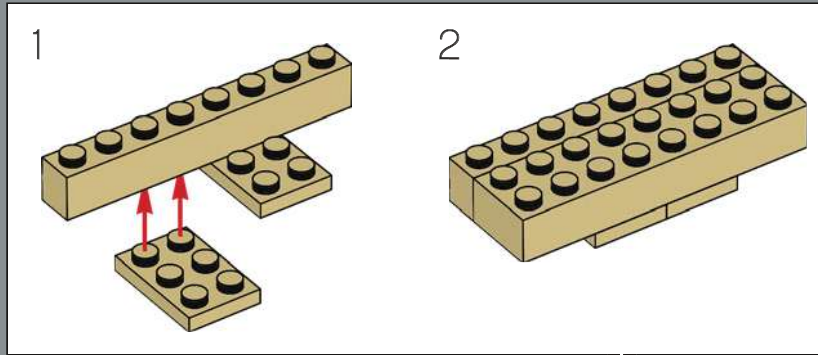

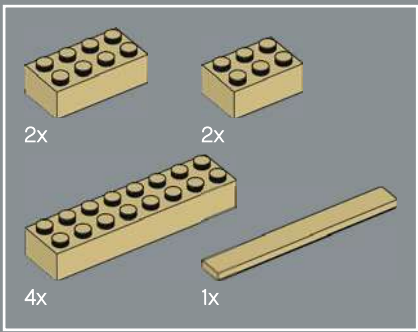

The largest of these blocks that were used to construct the Great Pyramid weighed up to 80 metric tonnes (88.1 tons).

87

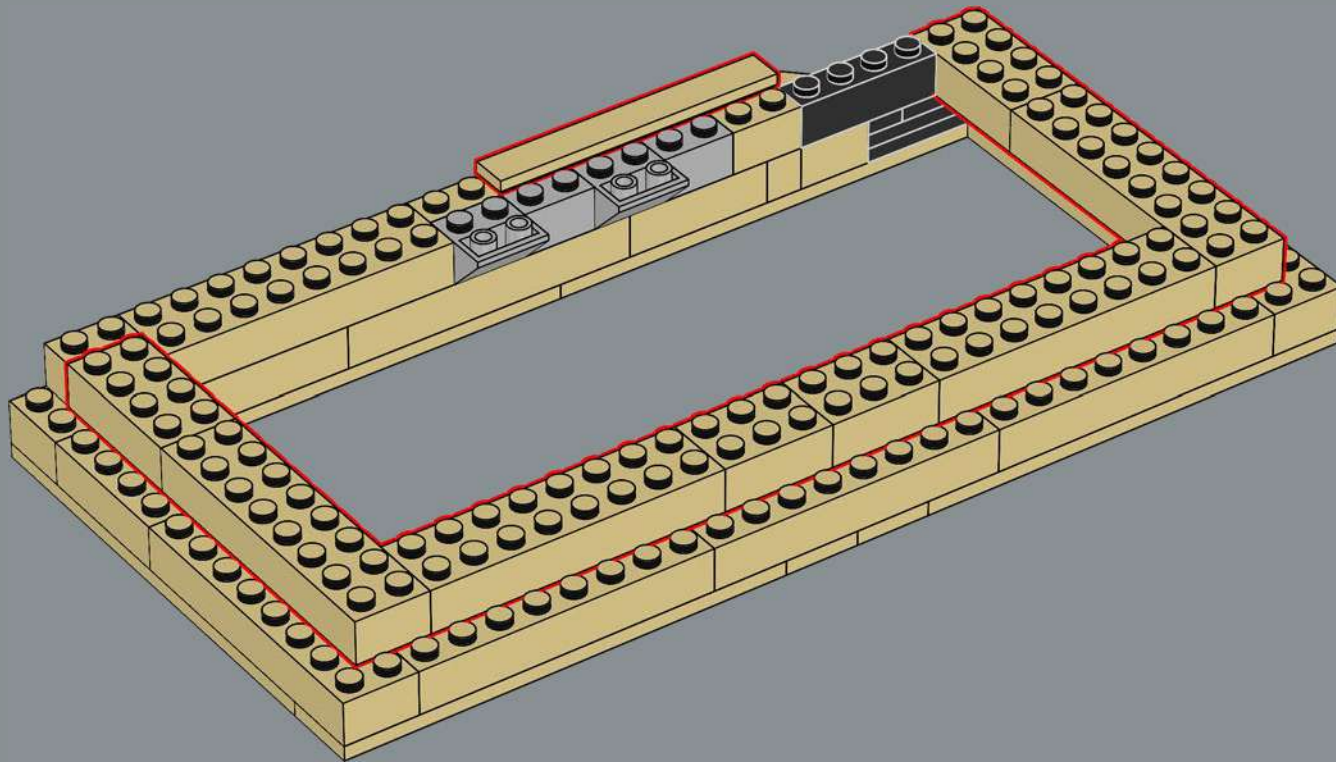

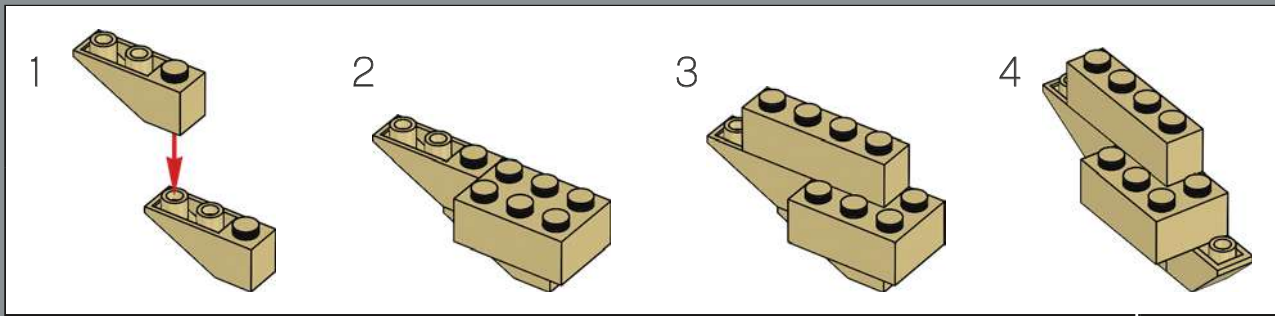
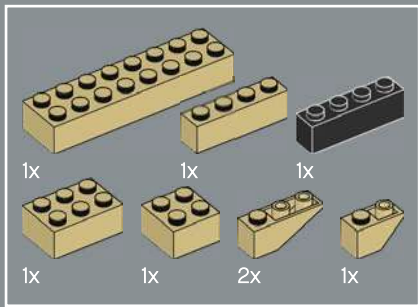

88

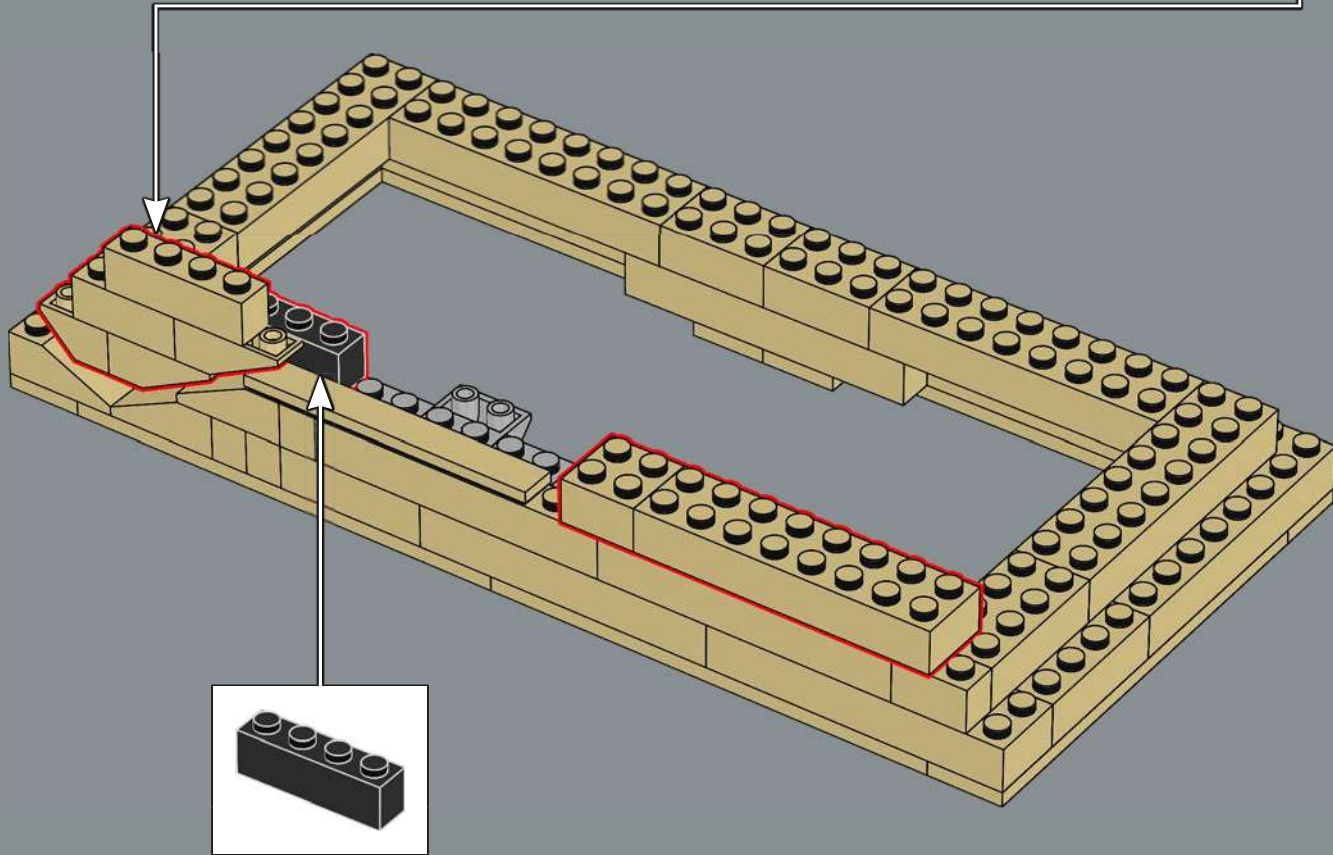

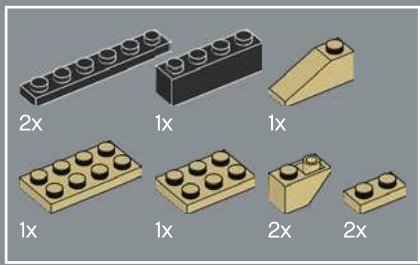

89

1

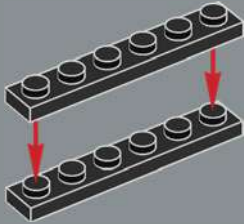

2

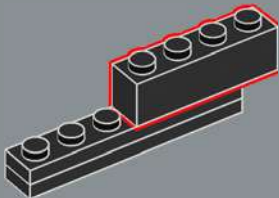

3

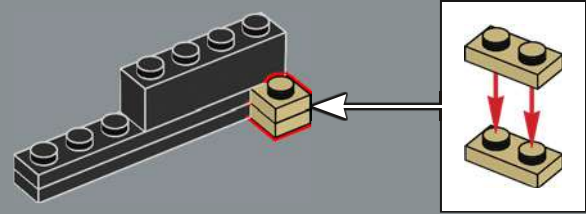

4

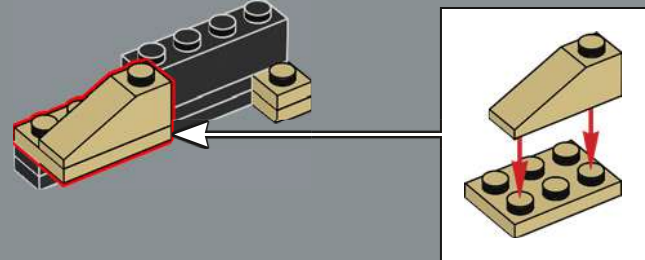

5

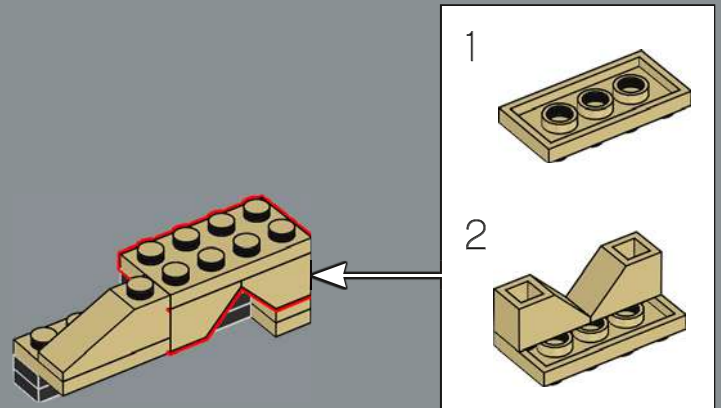

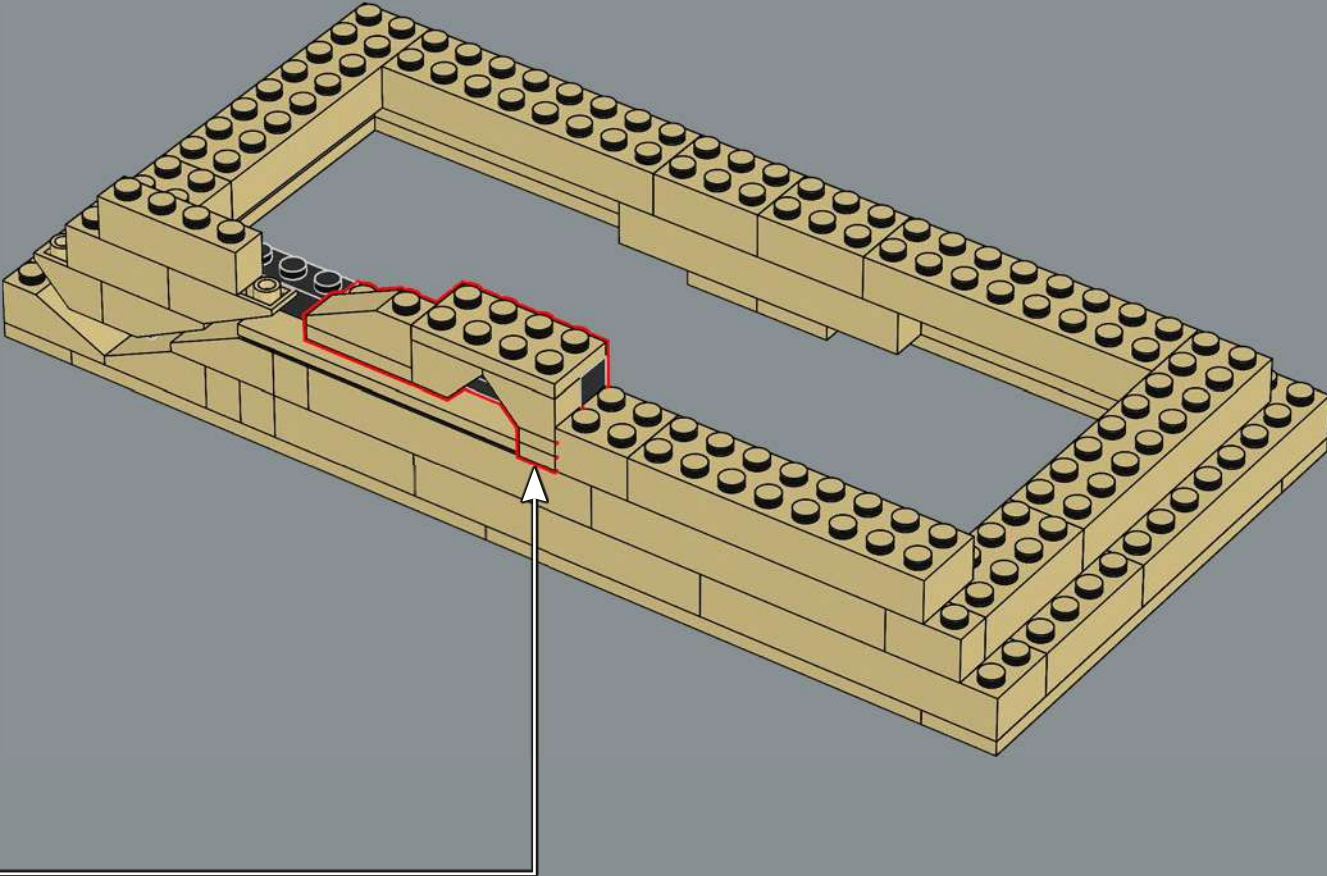

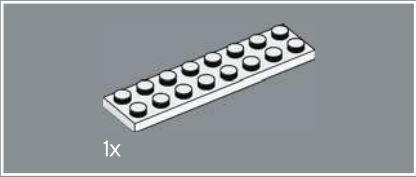
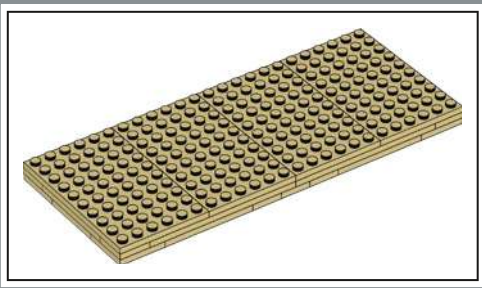

90

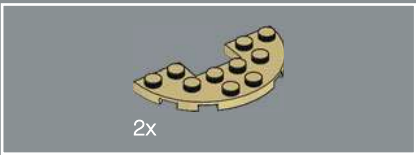
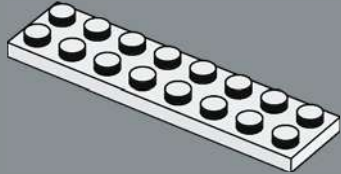

91

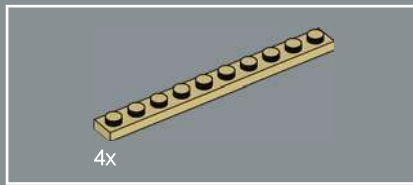
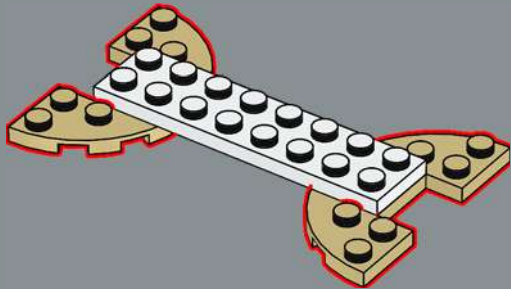

4x

92

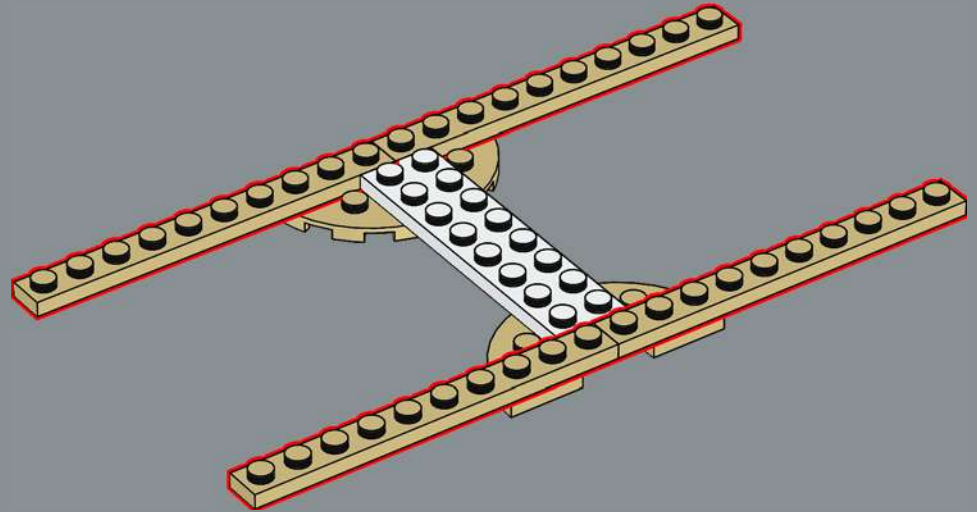

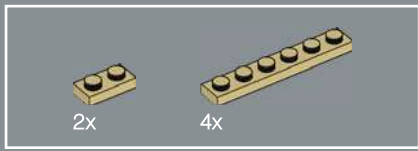

93

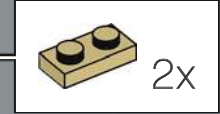
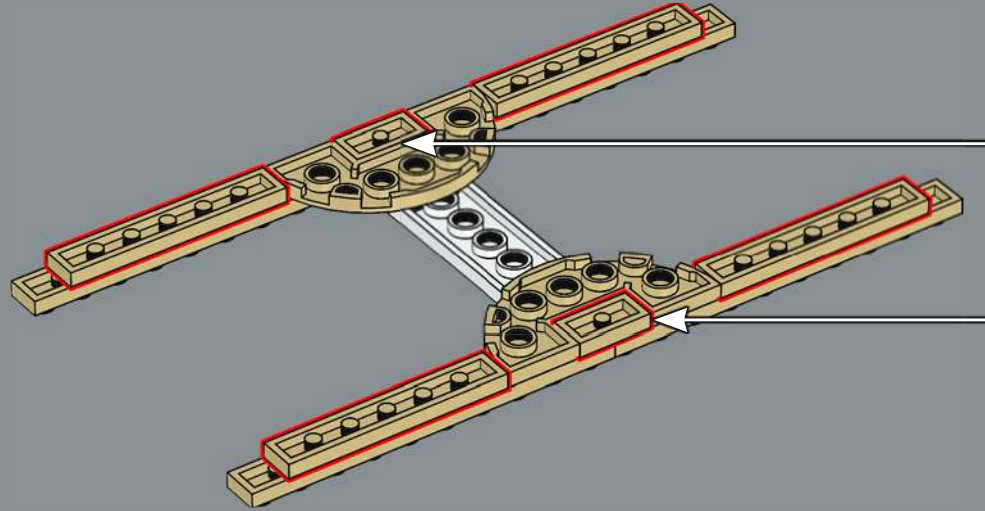

94

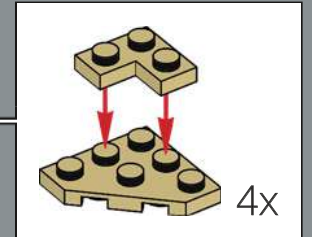
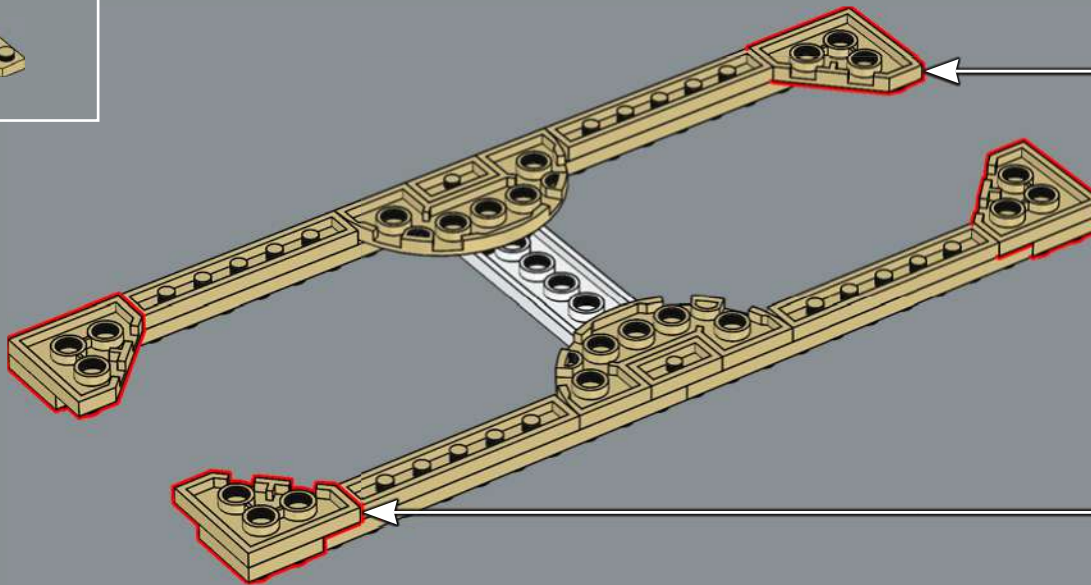

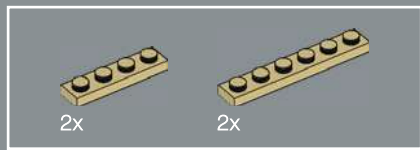

95

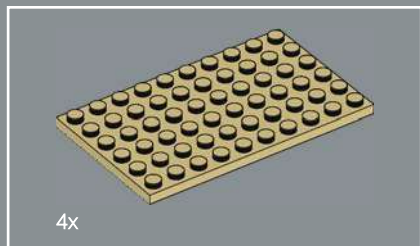
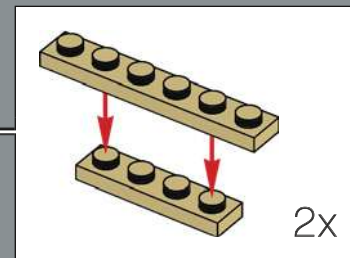
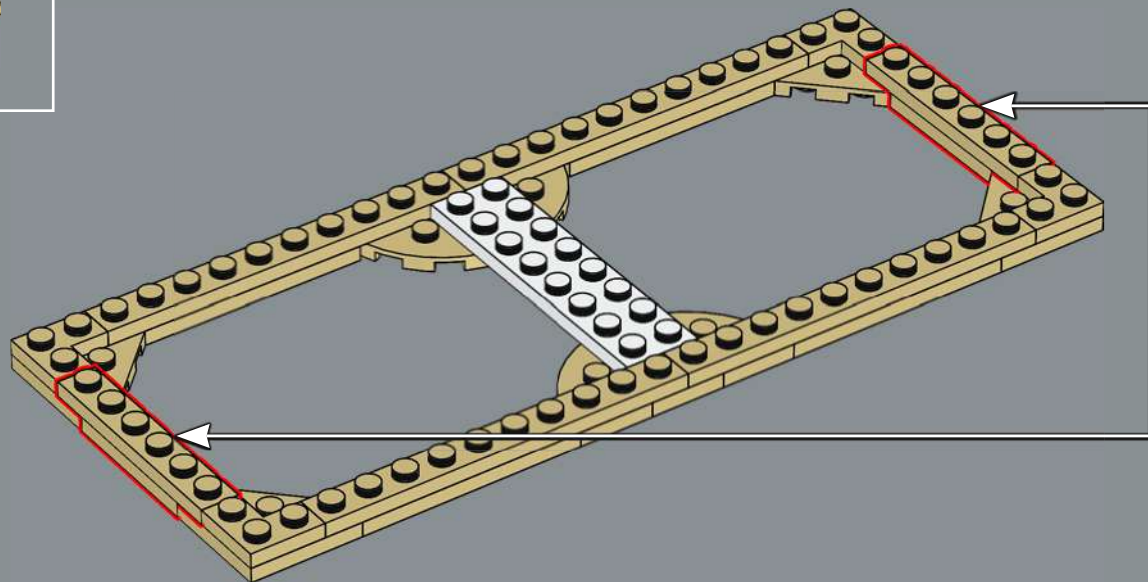

96

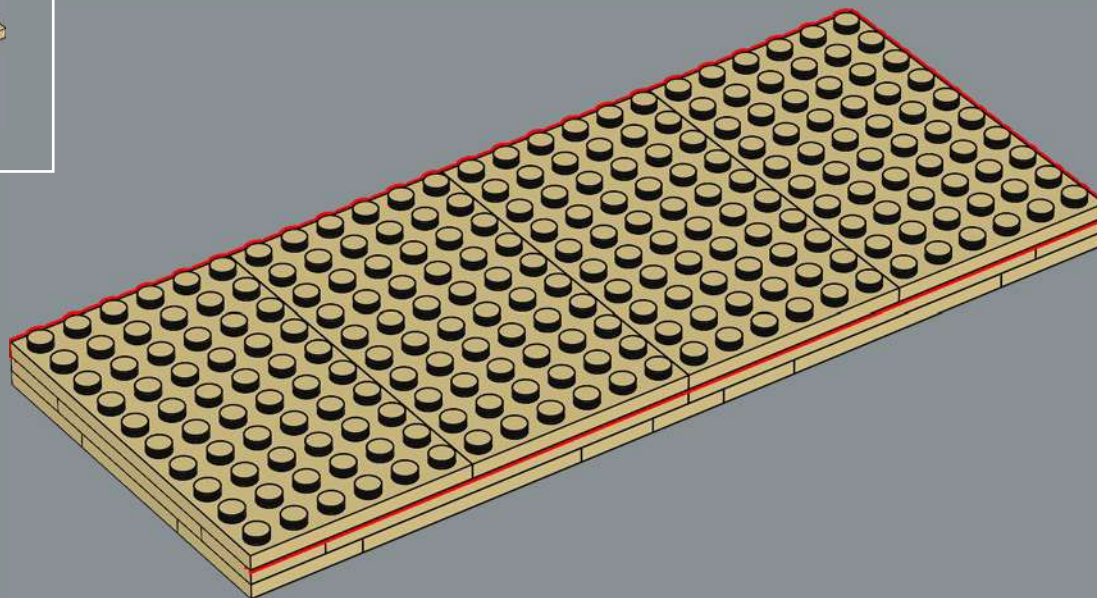

97

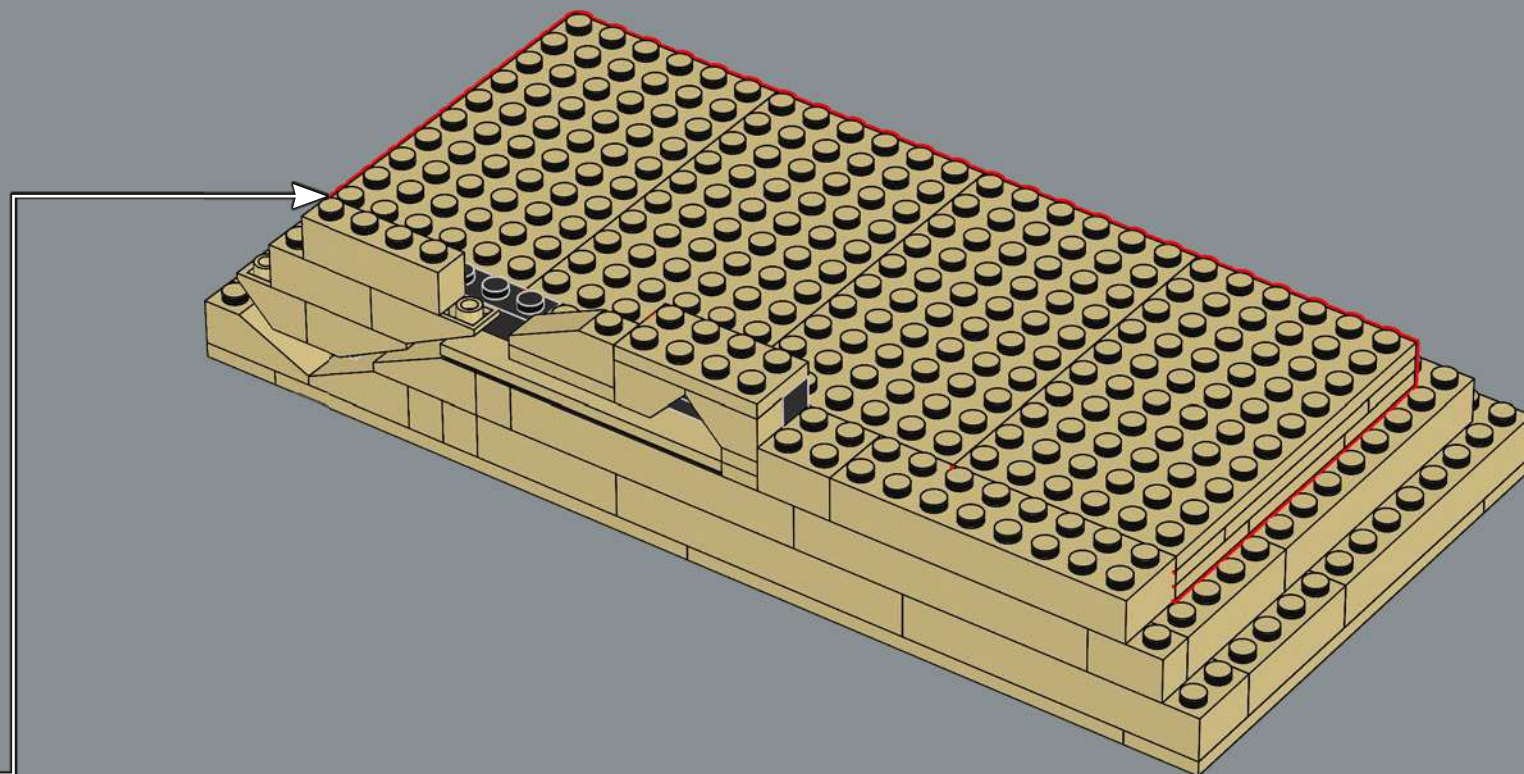

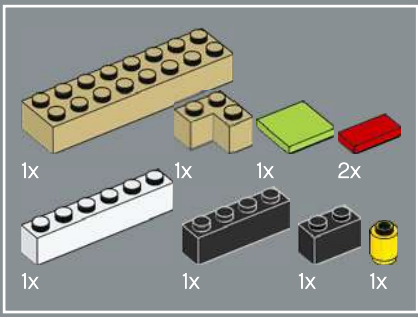

98

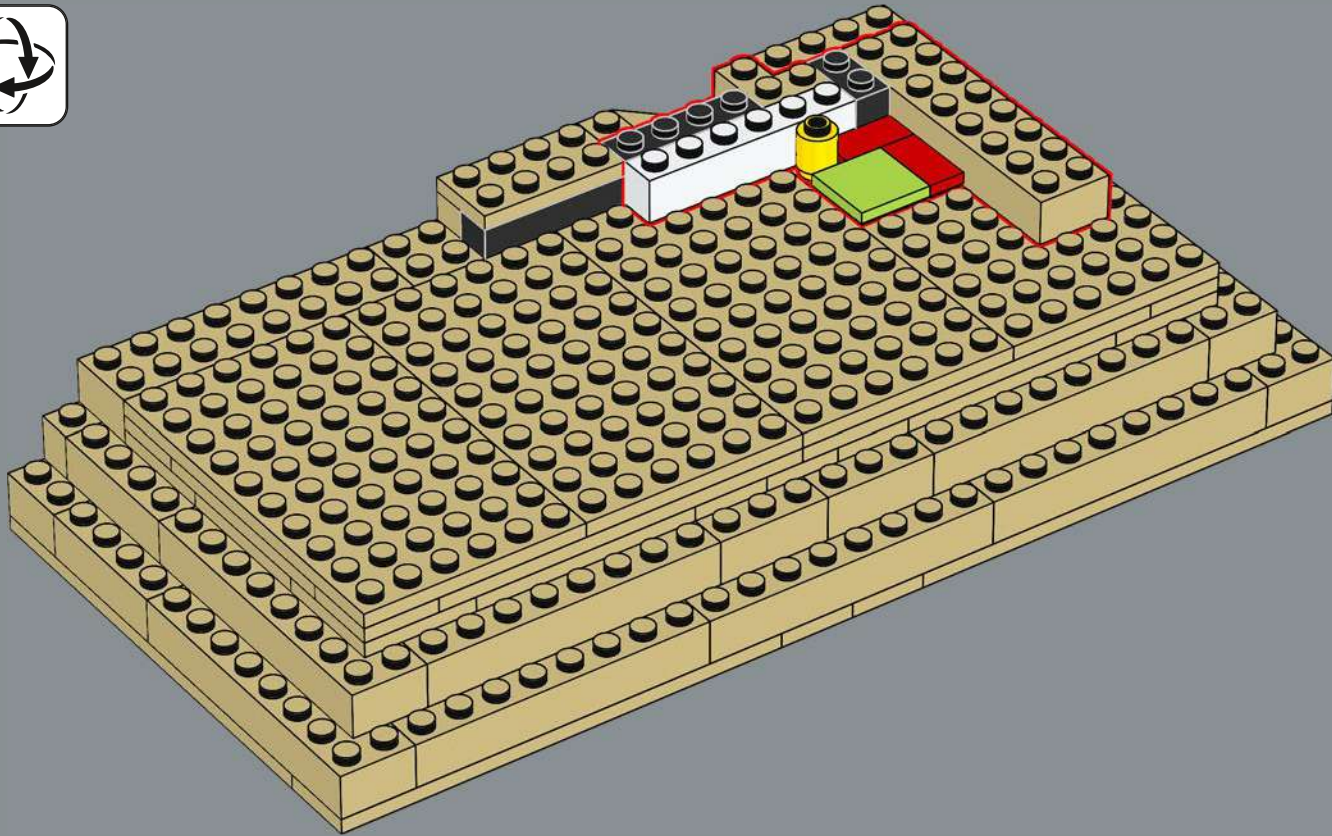

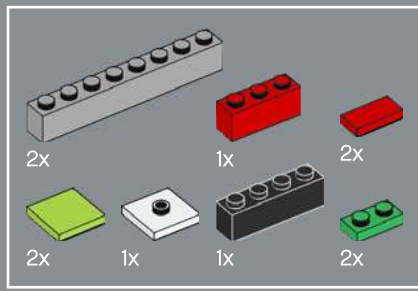

99

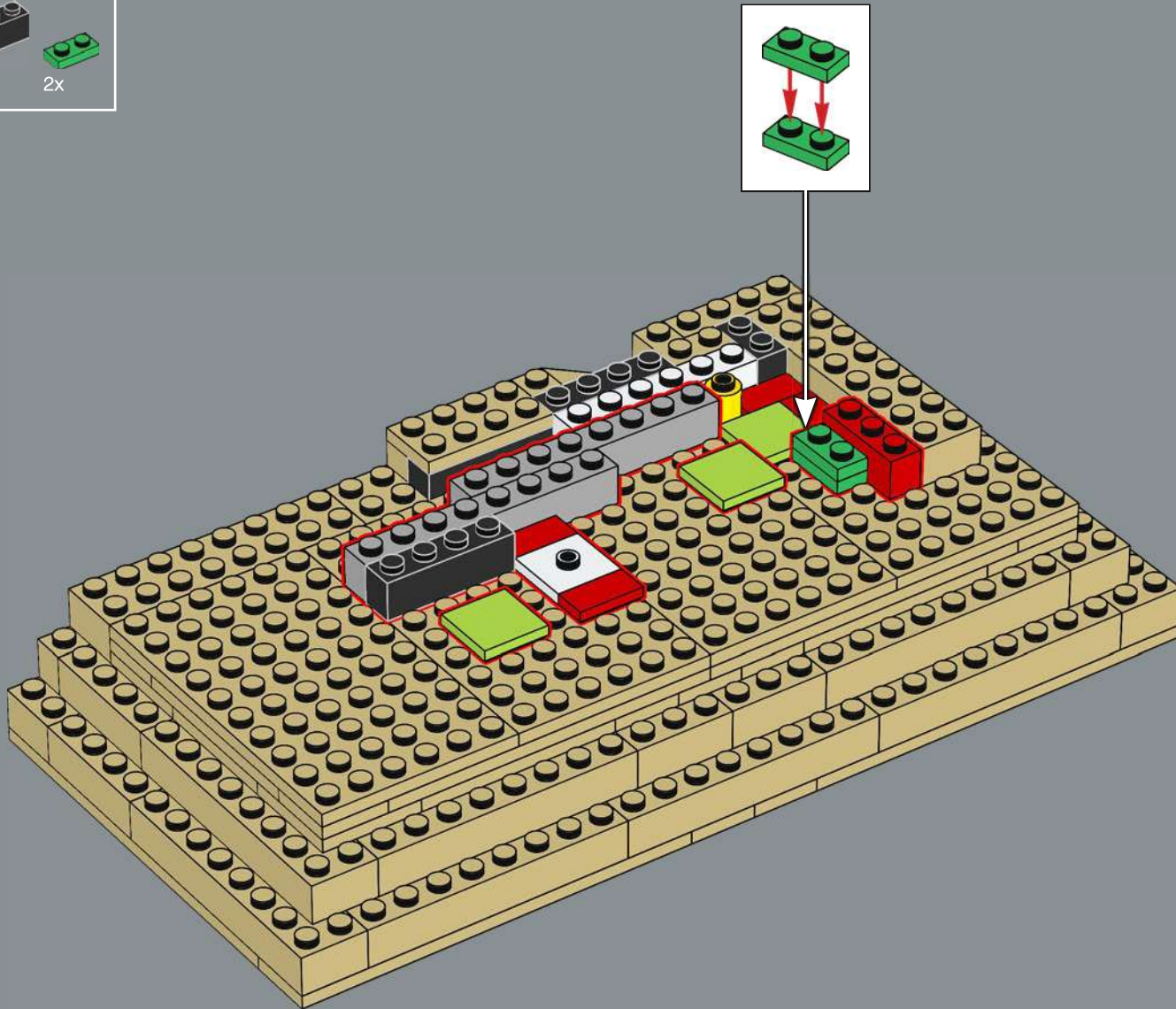

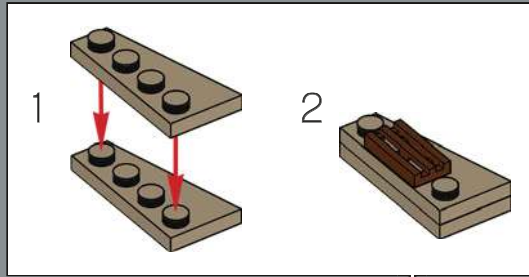
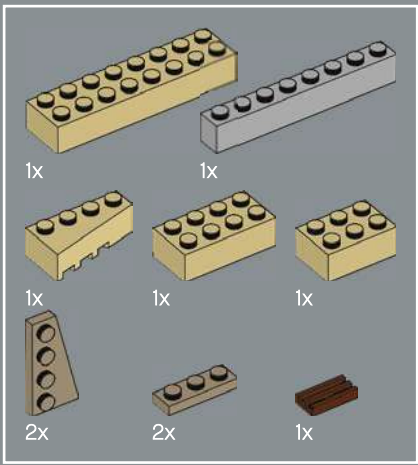

100

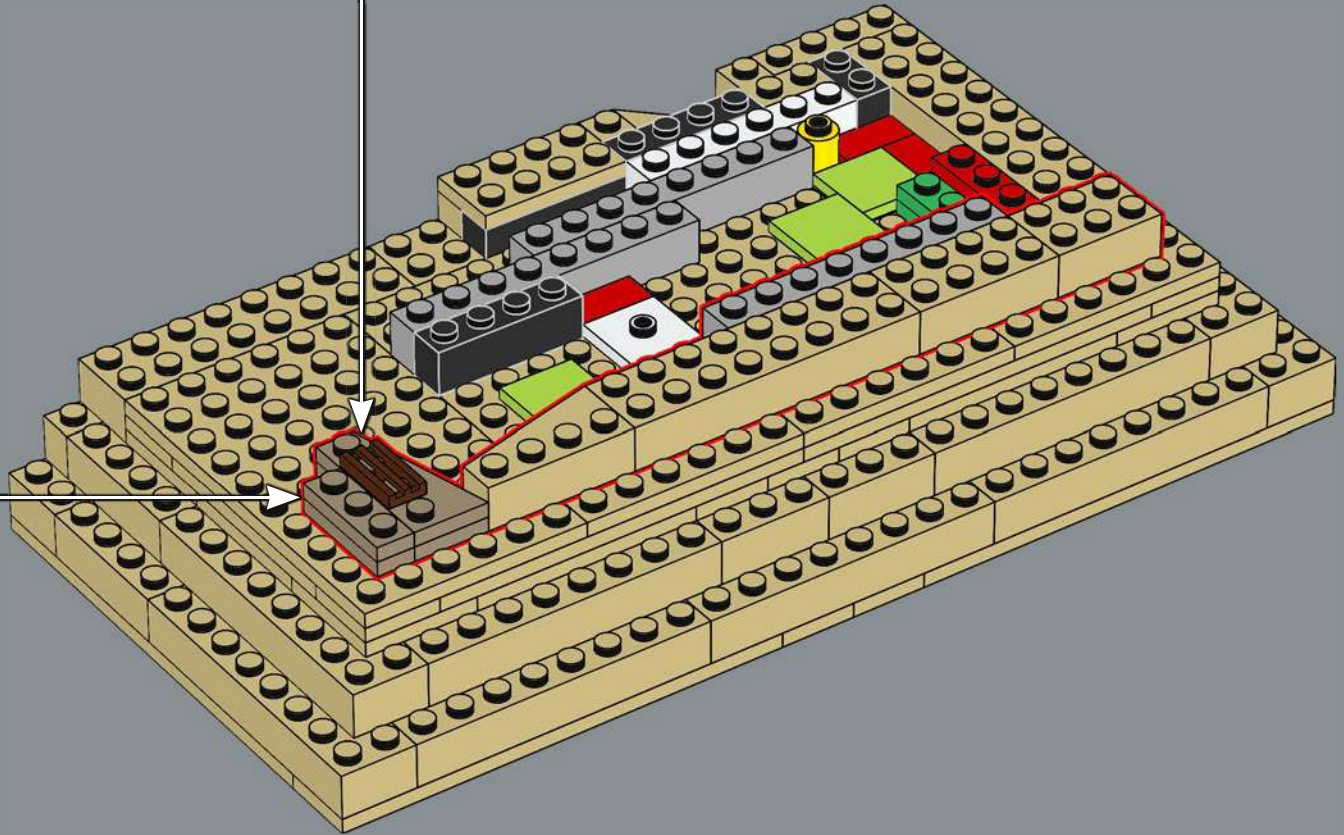
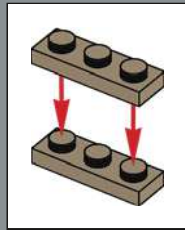

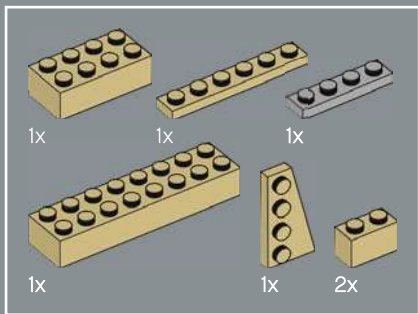

101

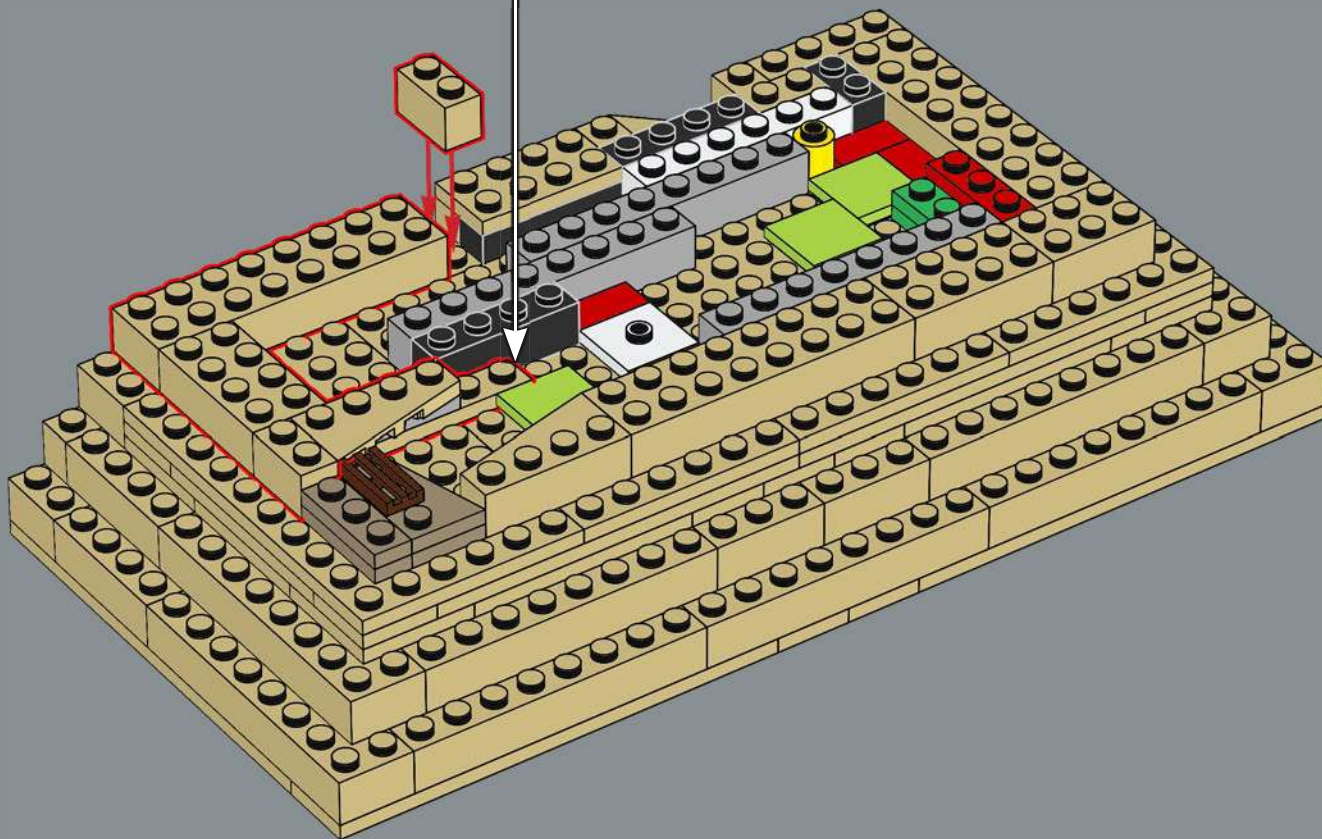
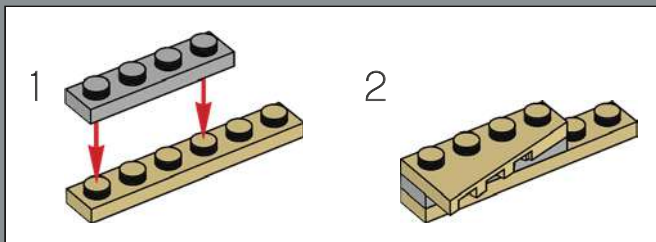

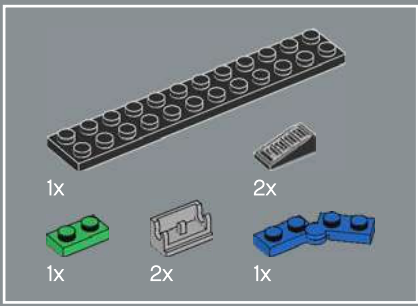

102

1

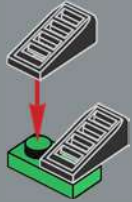

2

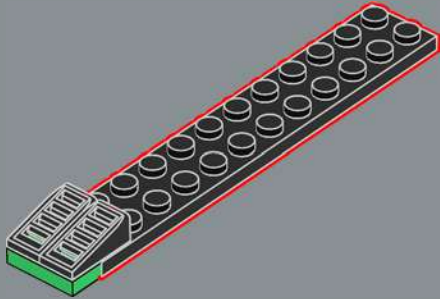

3

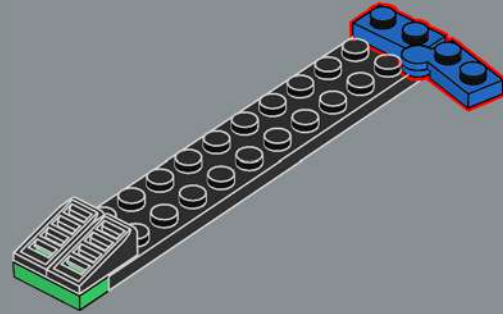

4

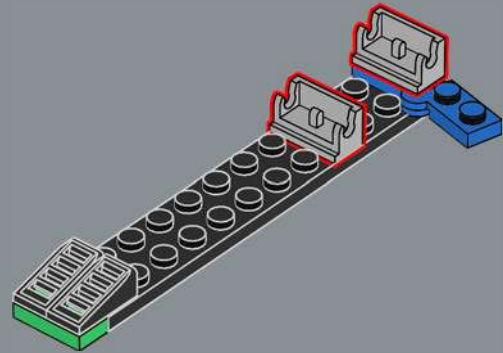

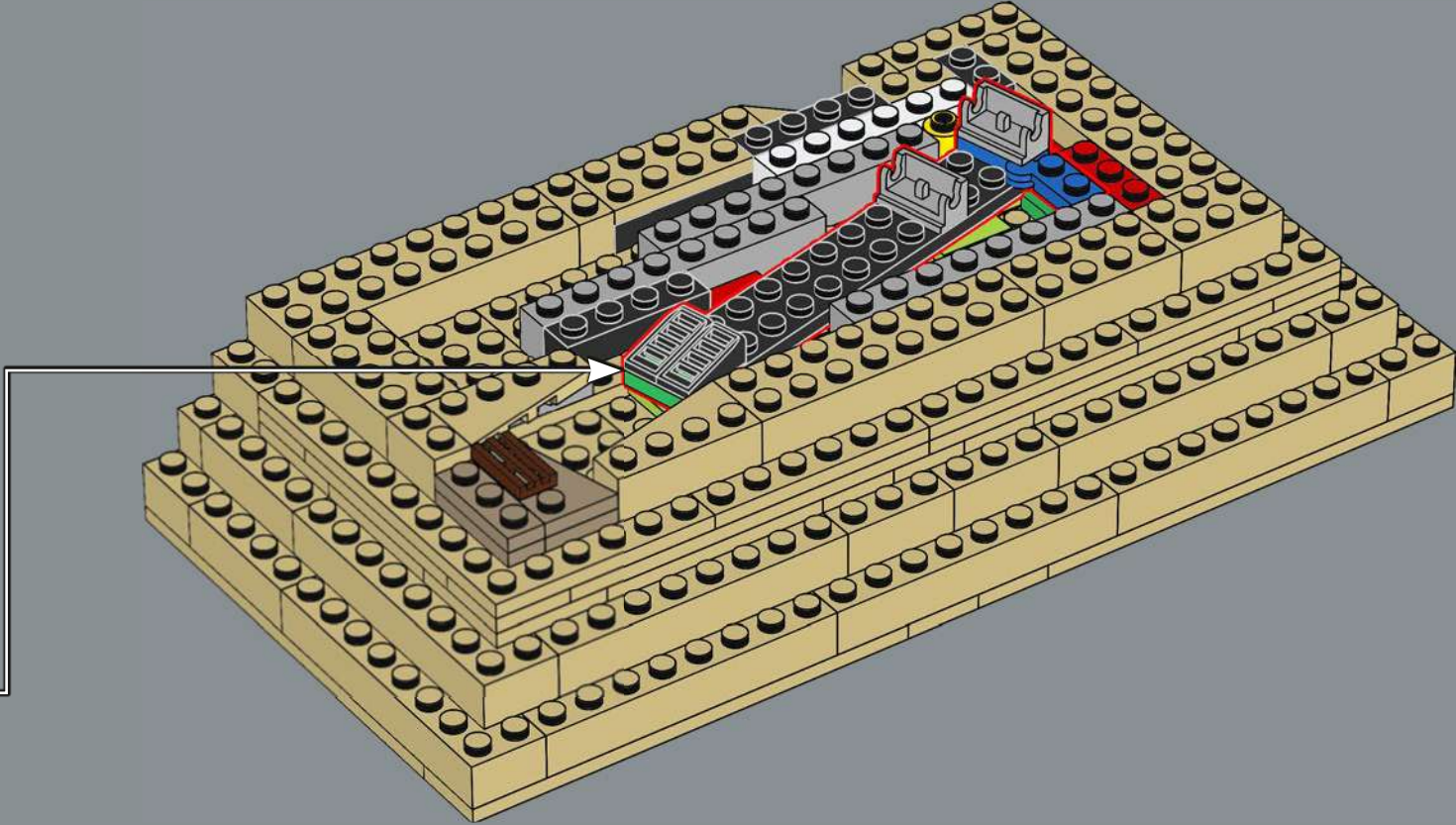

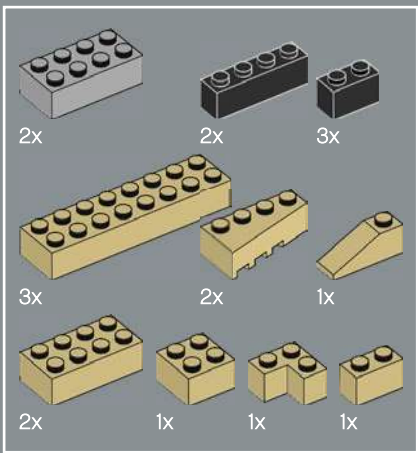

103

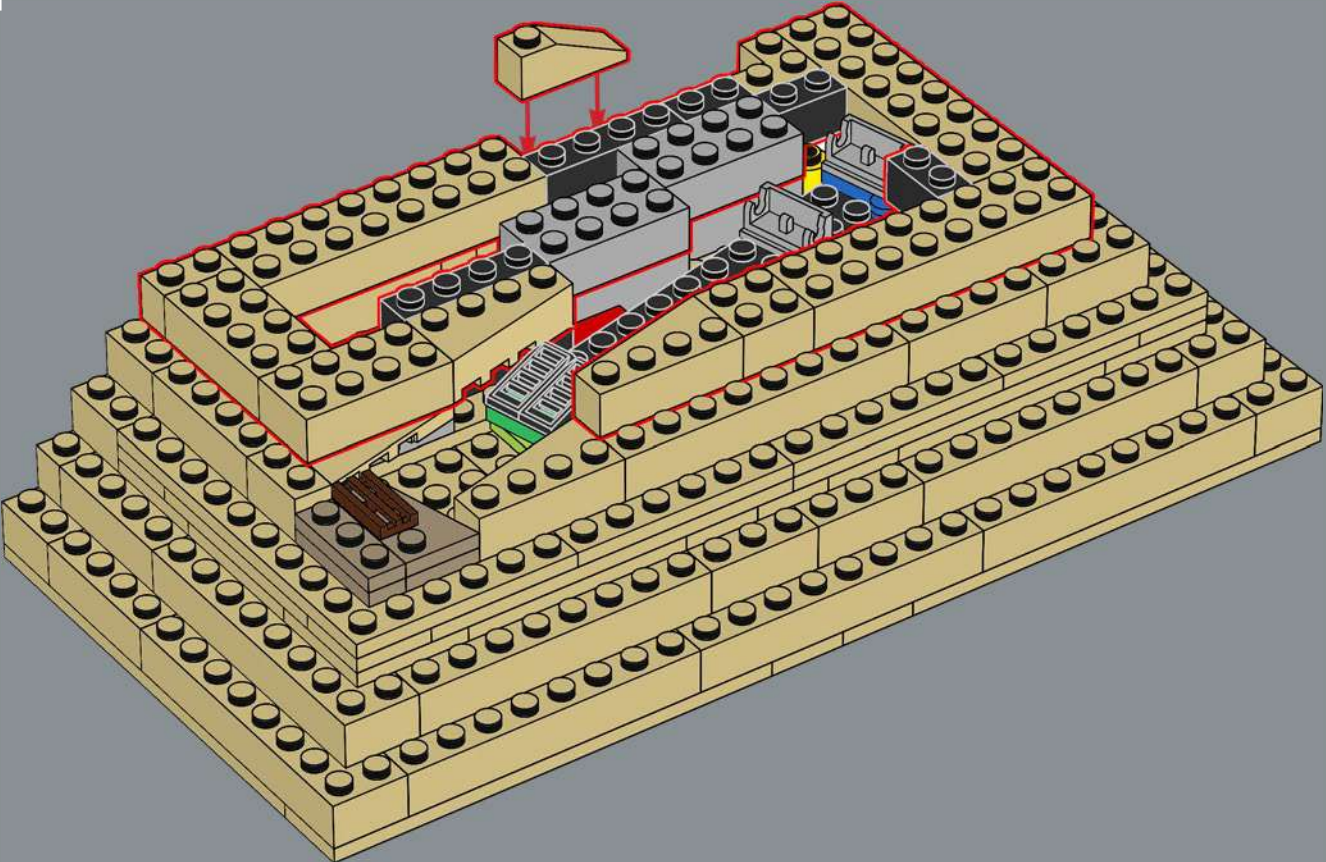

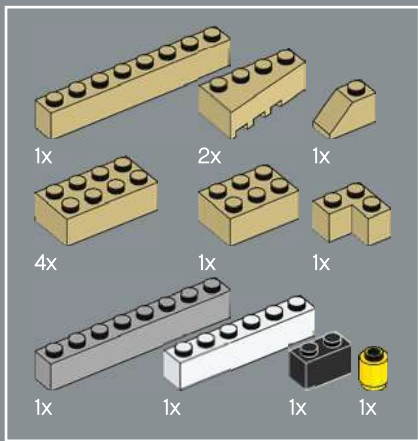

104

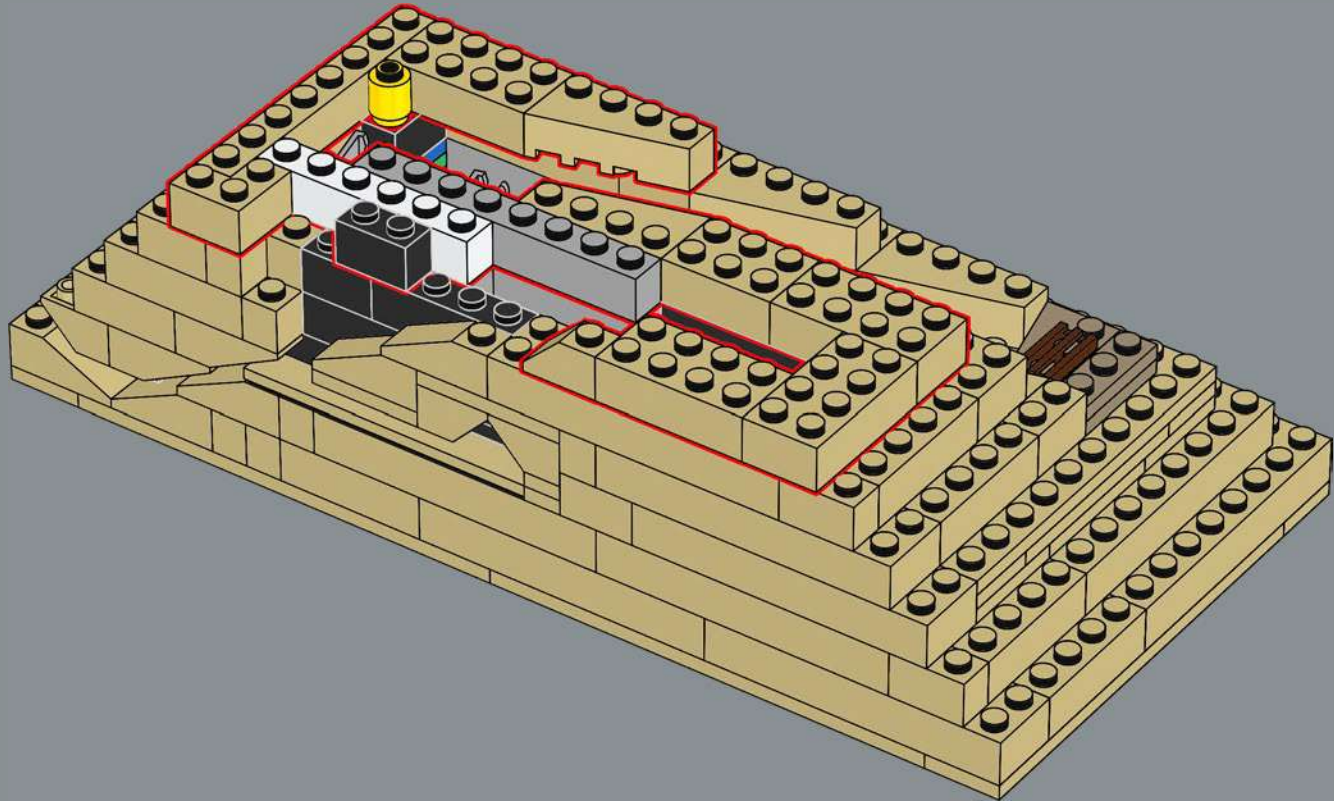

105

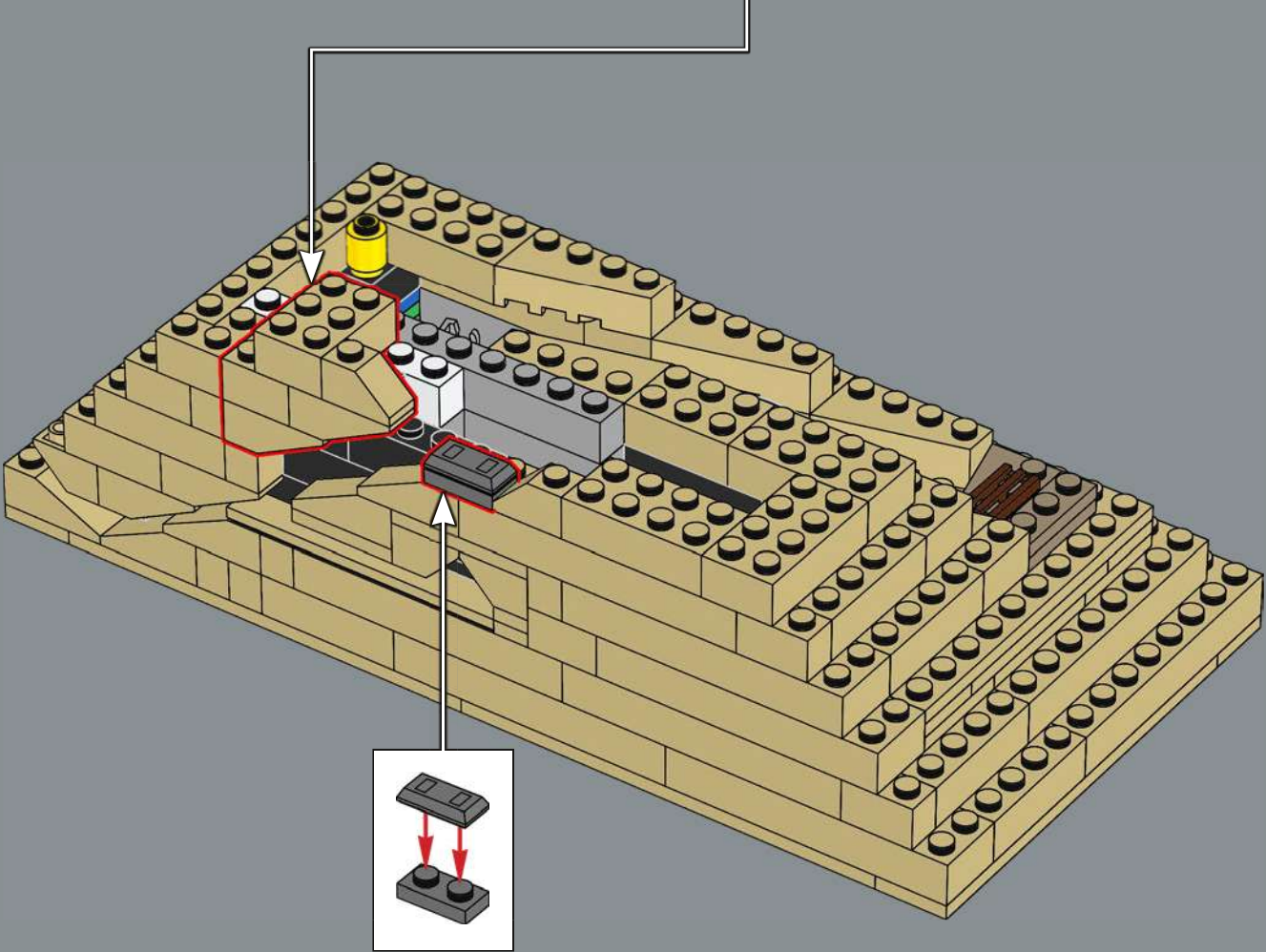
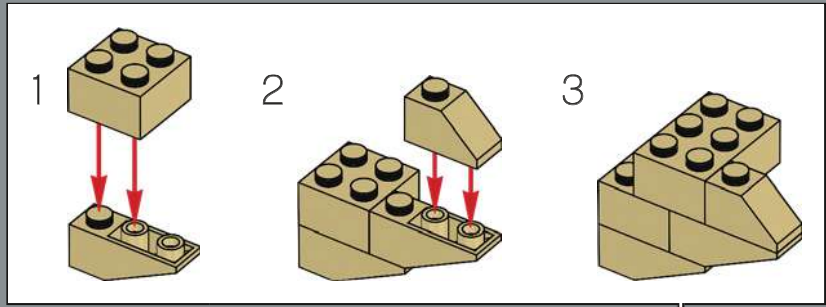
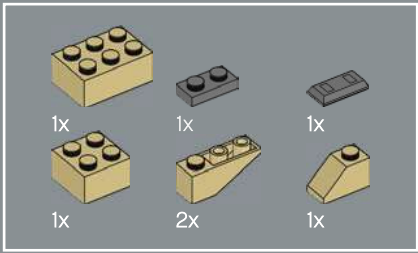

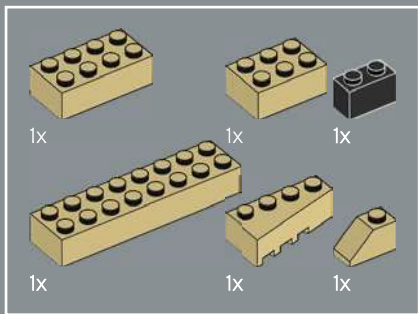

106

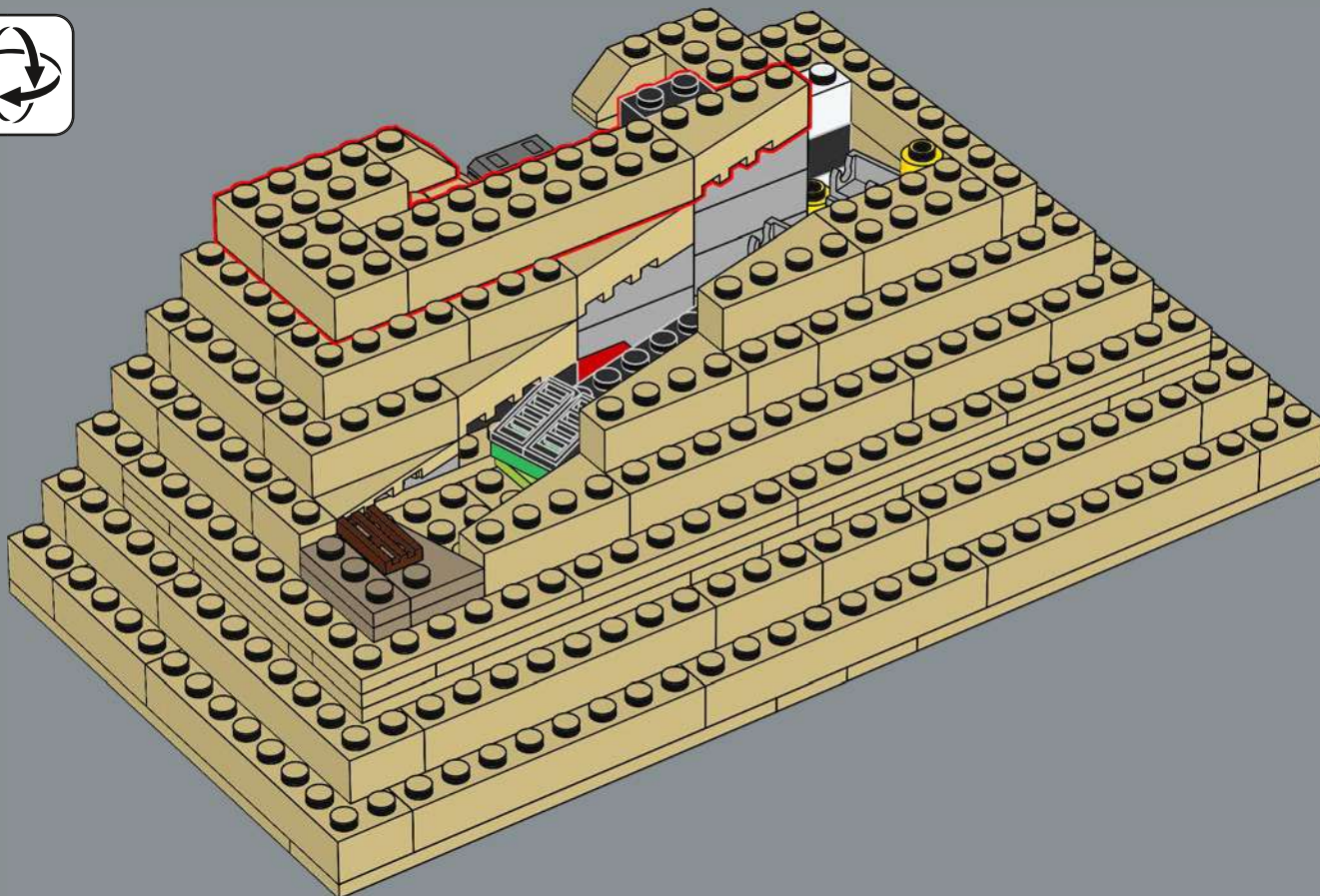

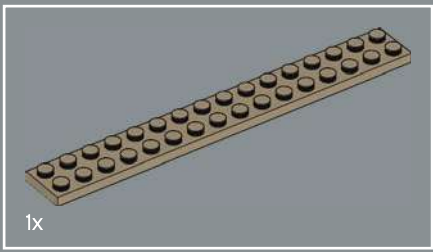

107

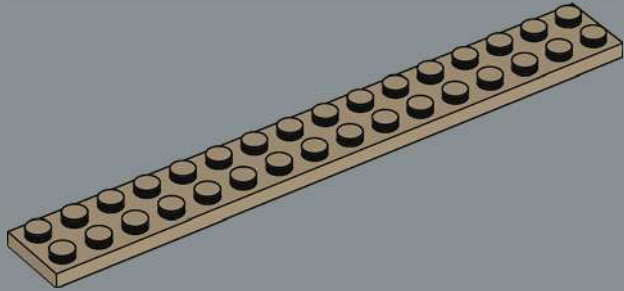

108

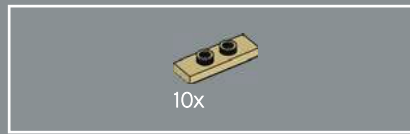
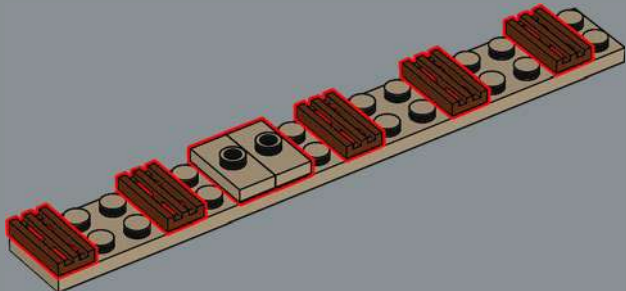

109

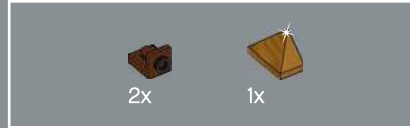
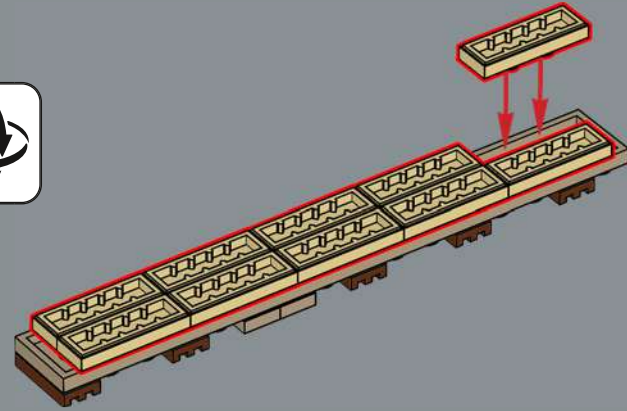

110

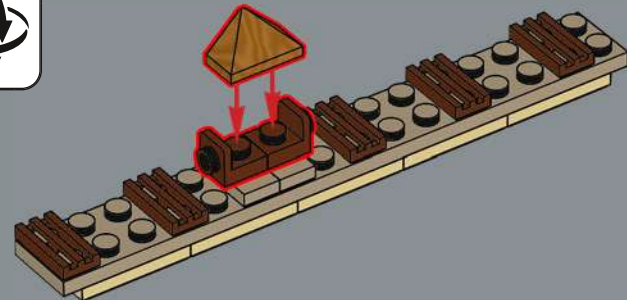

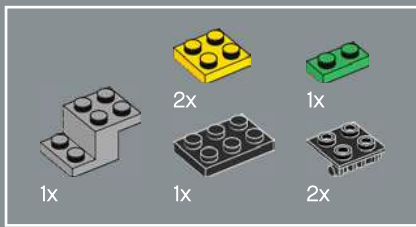

111

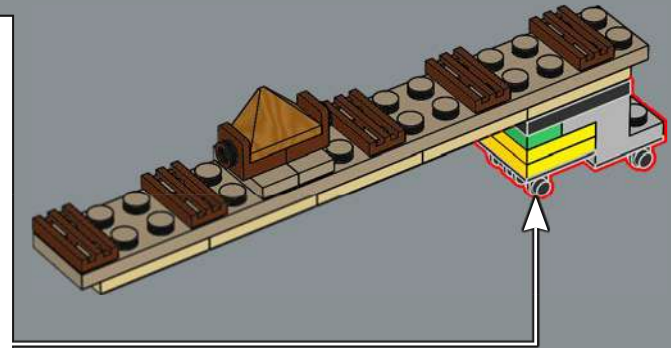
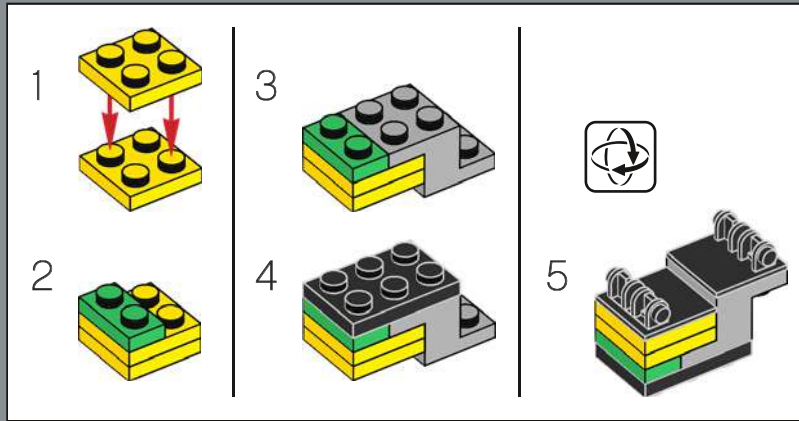

112

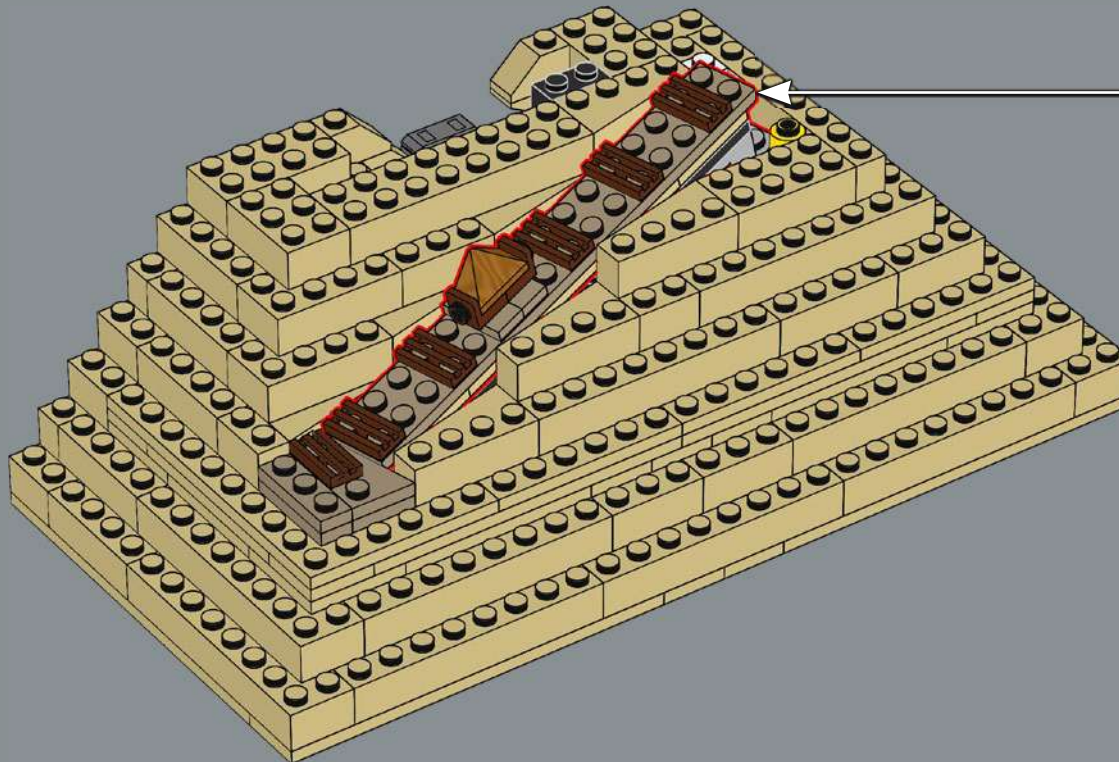

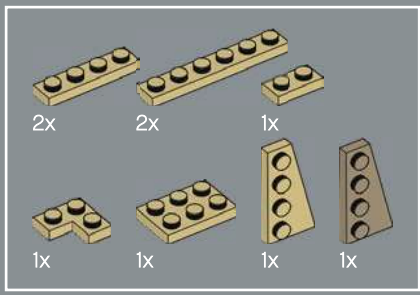

113

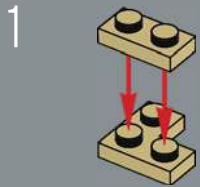

2

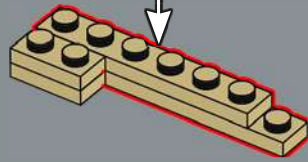
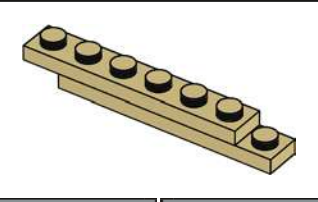

3

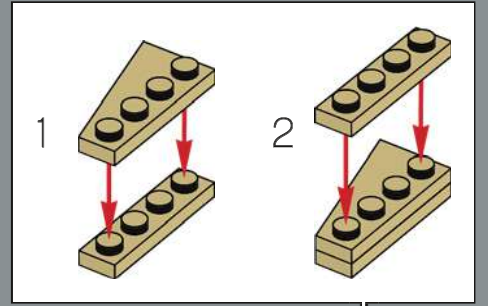
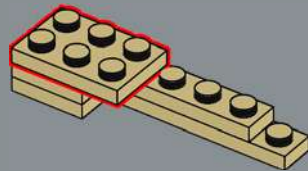

4

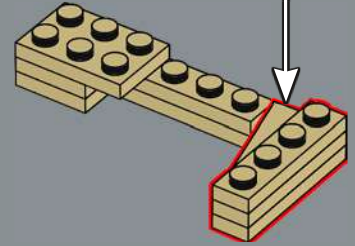

5

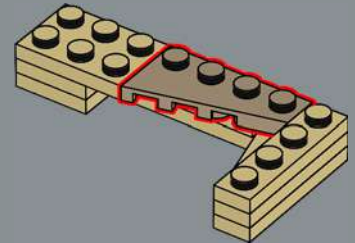

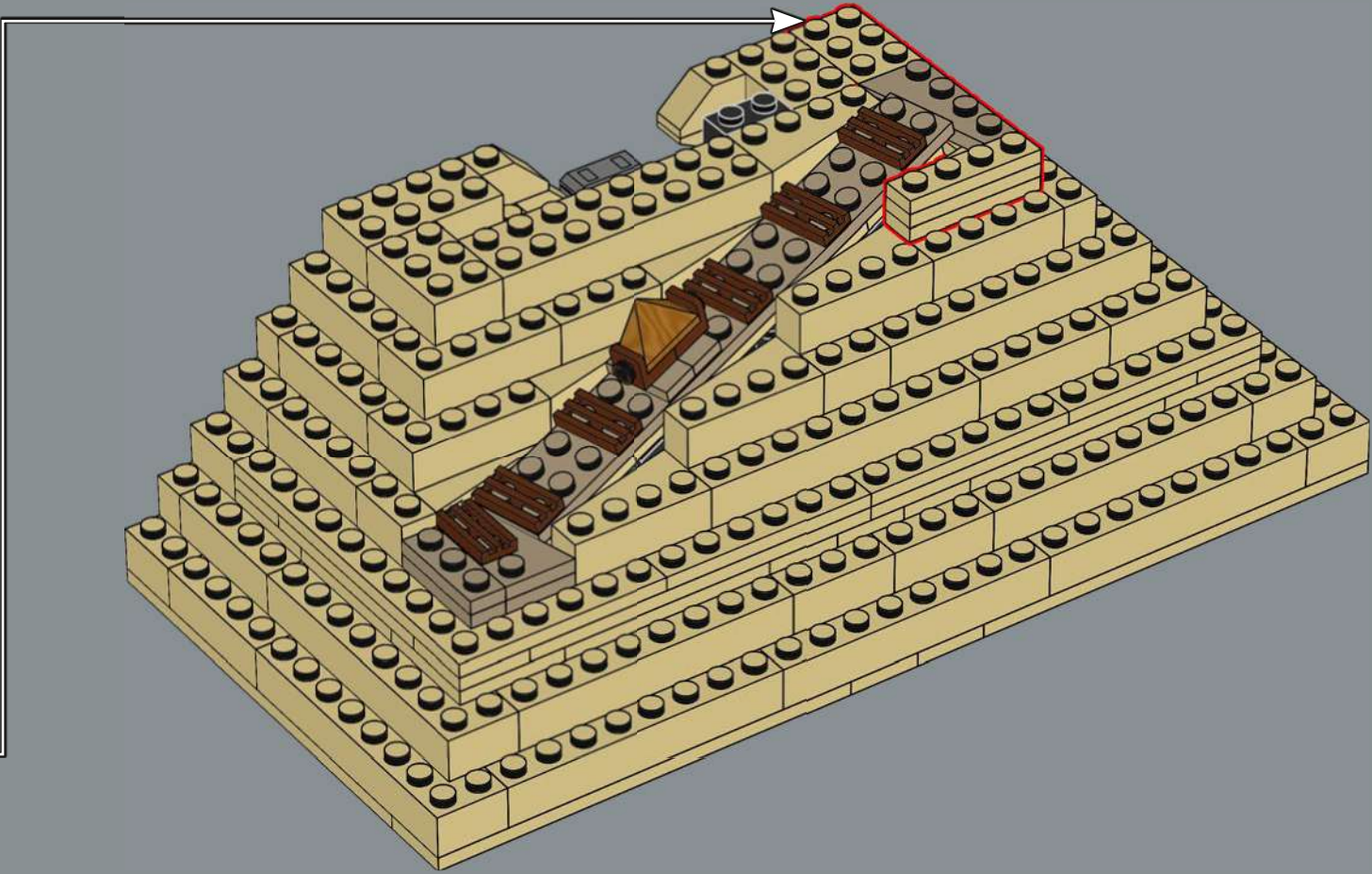

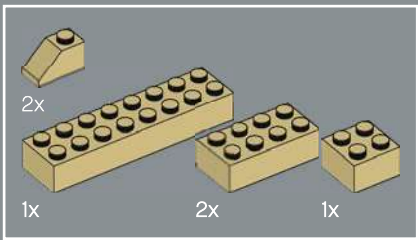

114

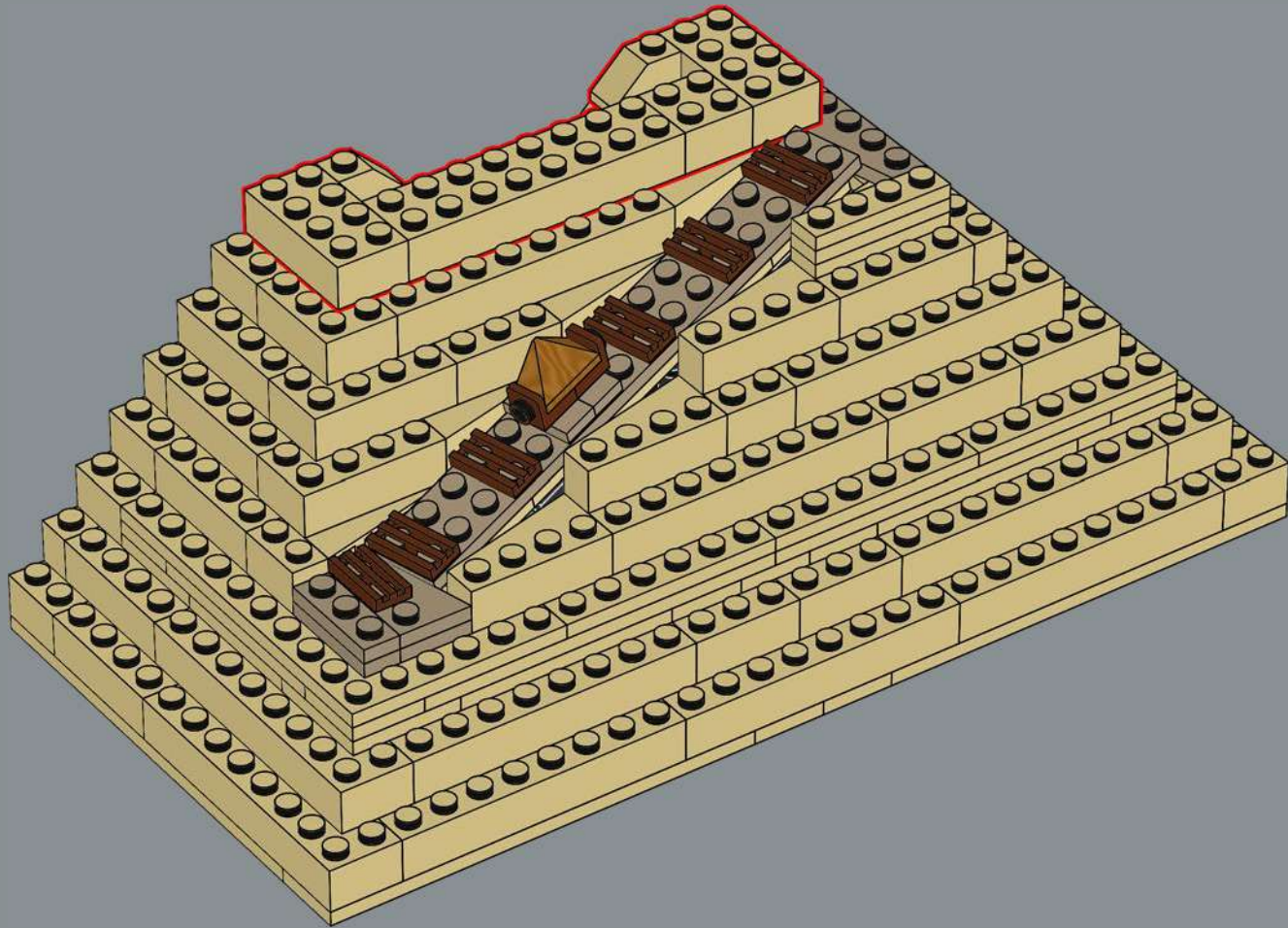



115

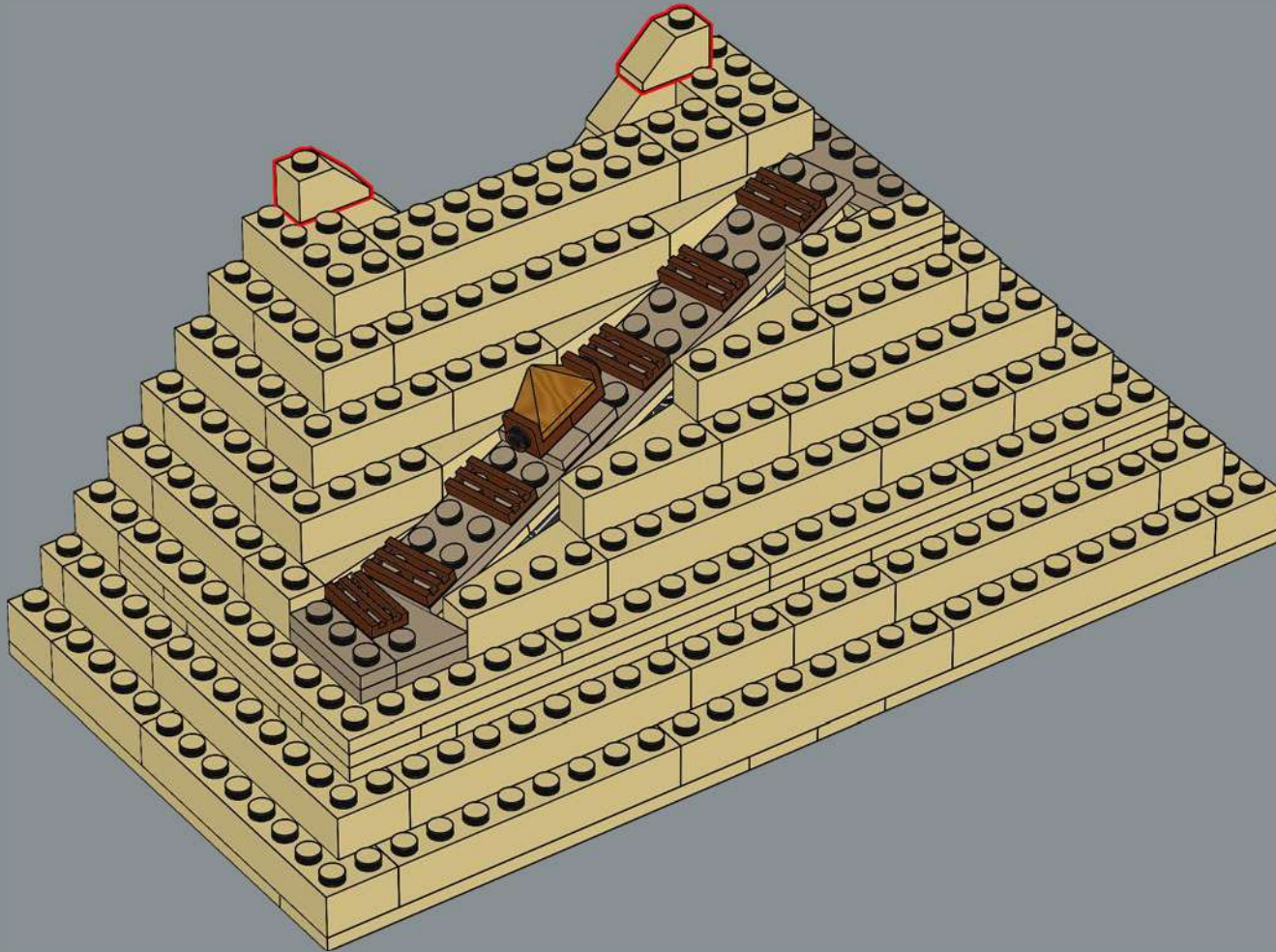



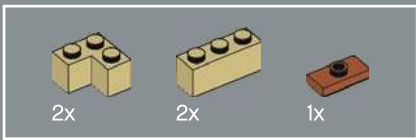

116

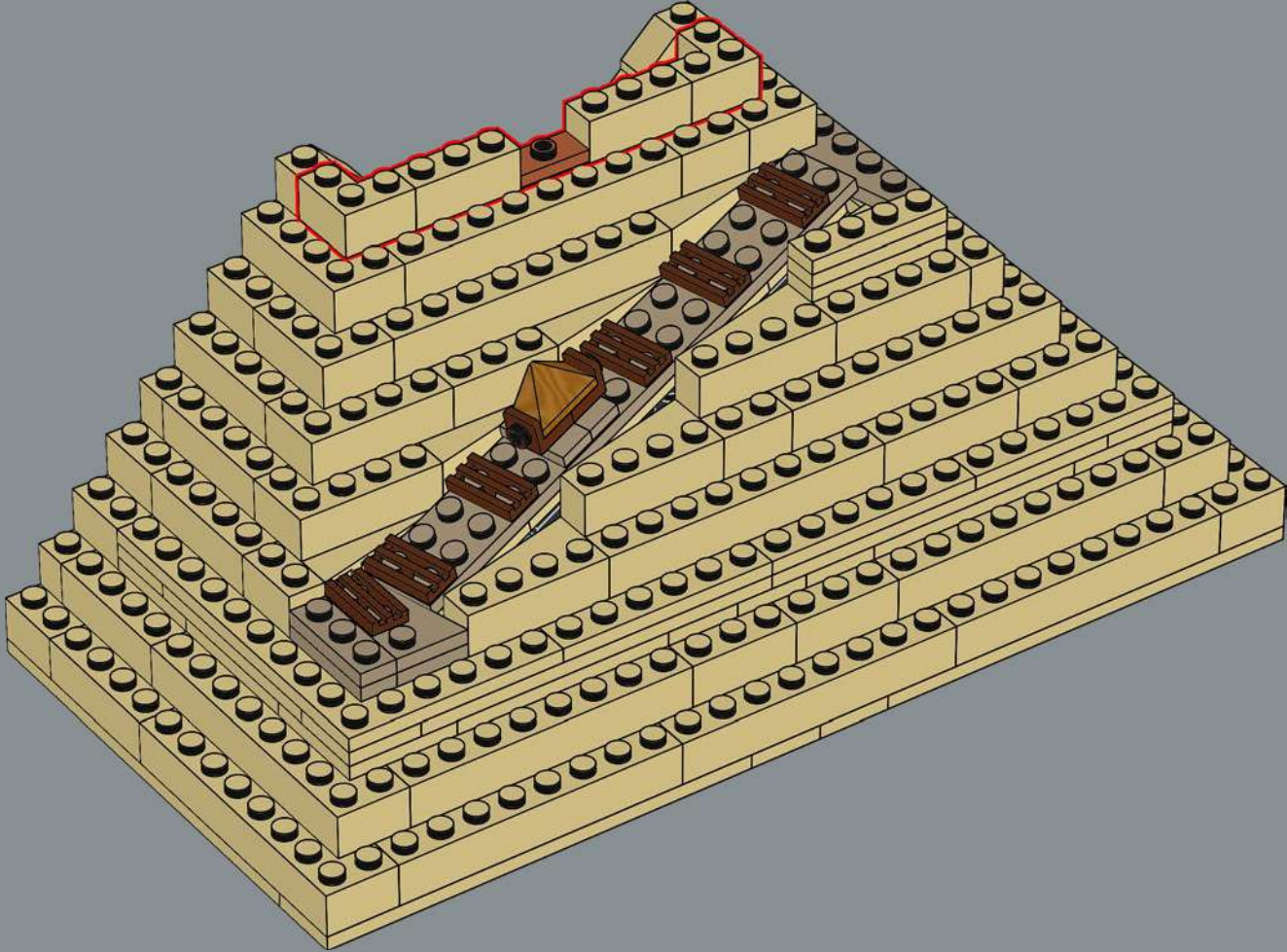

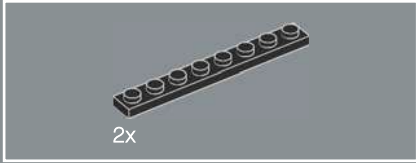
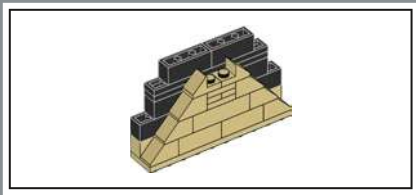

117

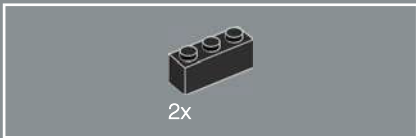
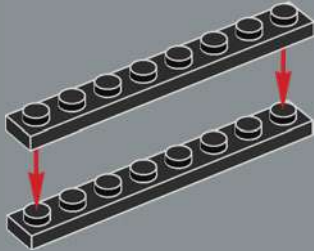

118

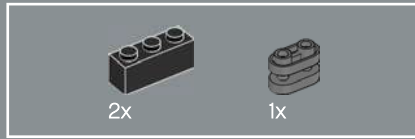
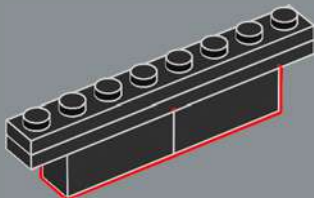

119

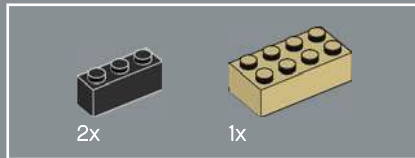
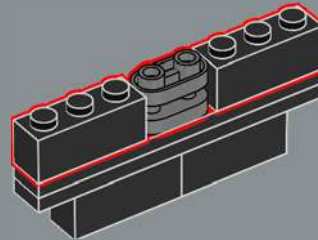

120

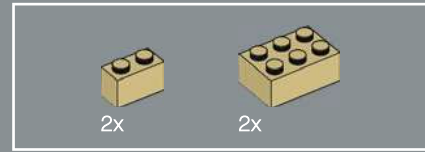
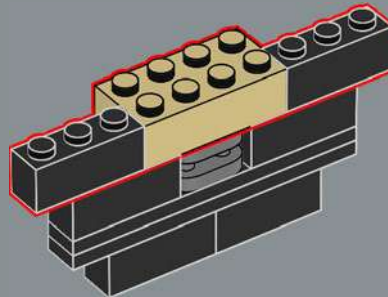

121

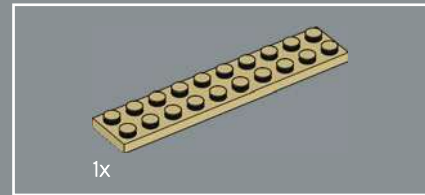
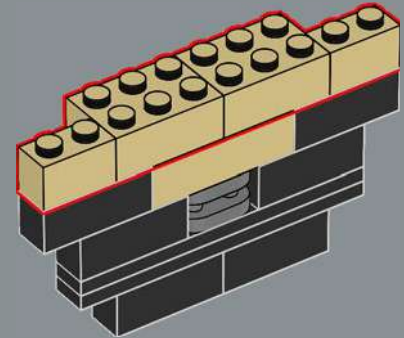

122

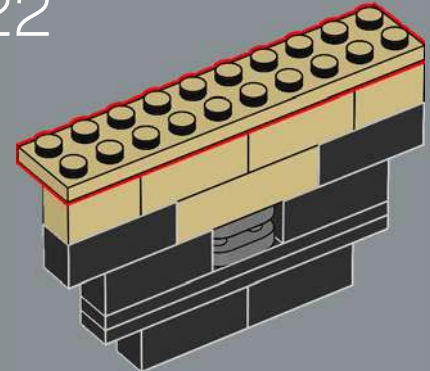

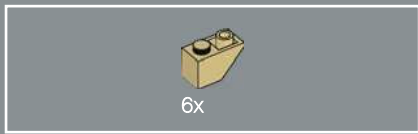

123

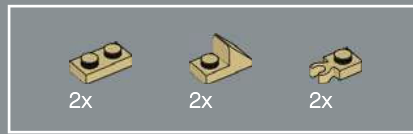
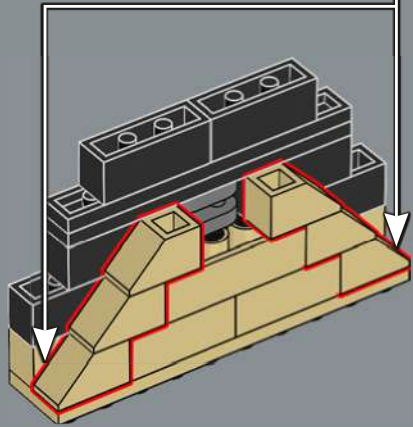
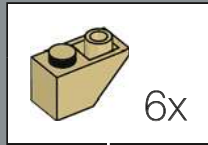

124

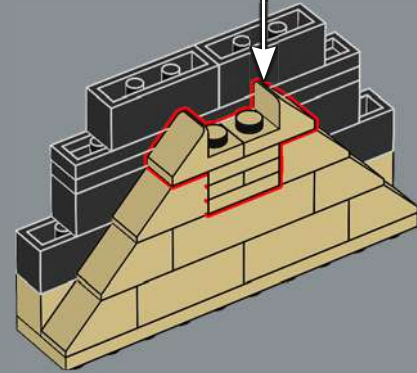
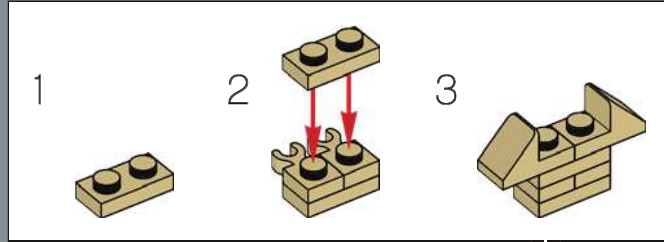

125

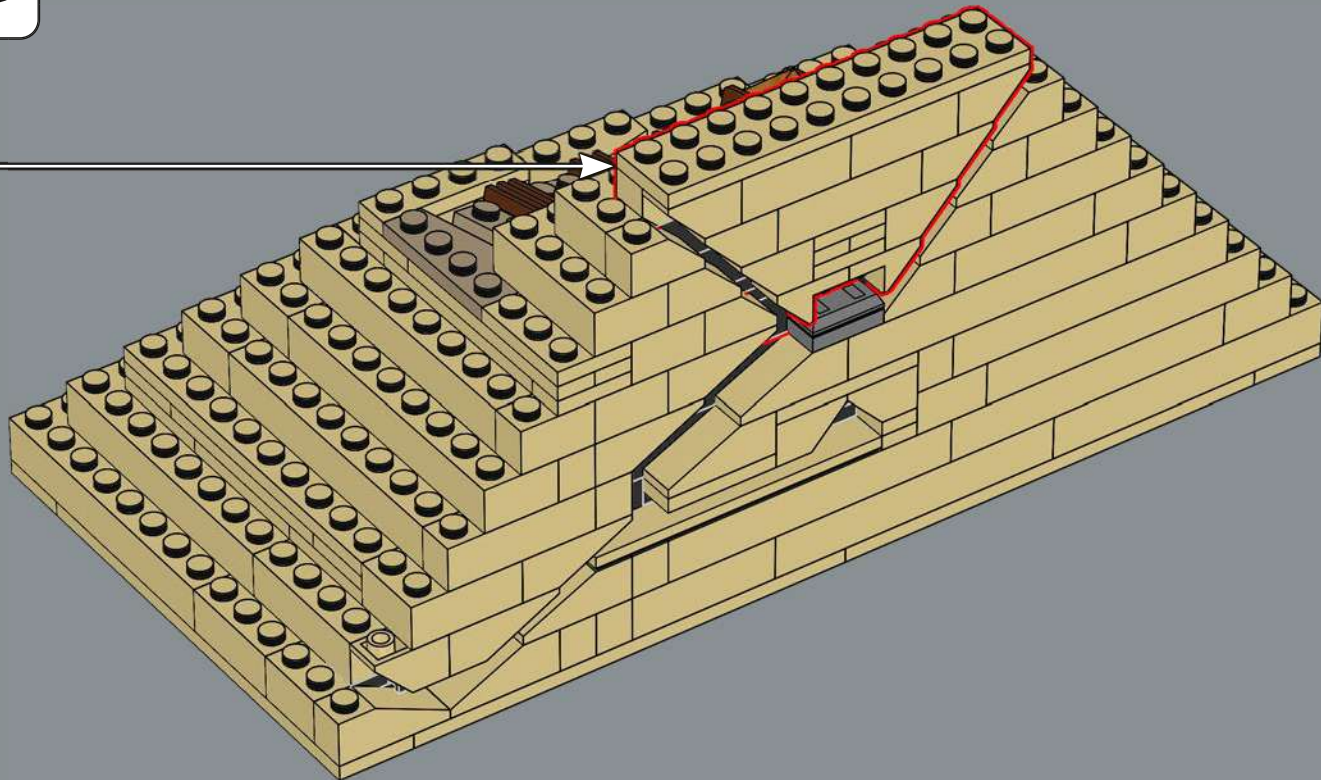

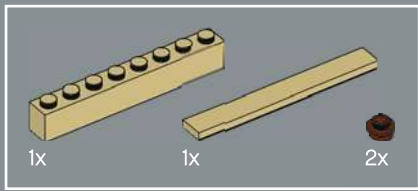

126

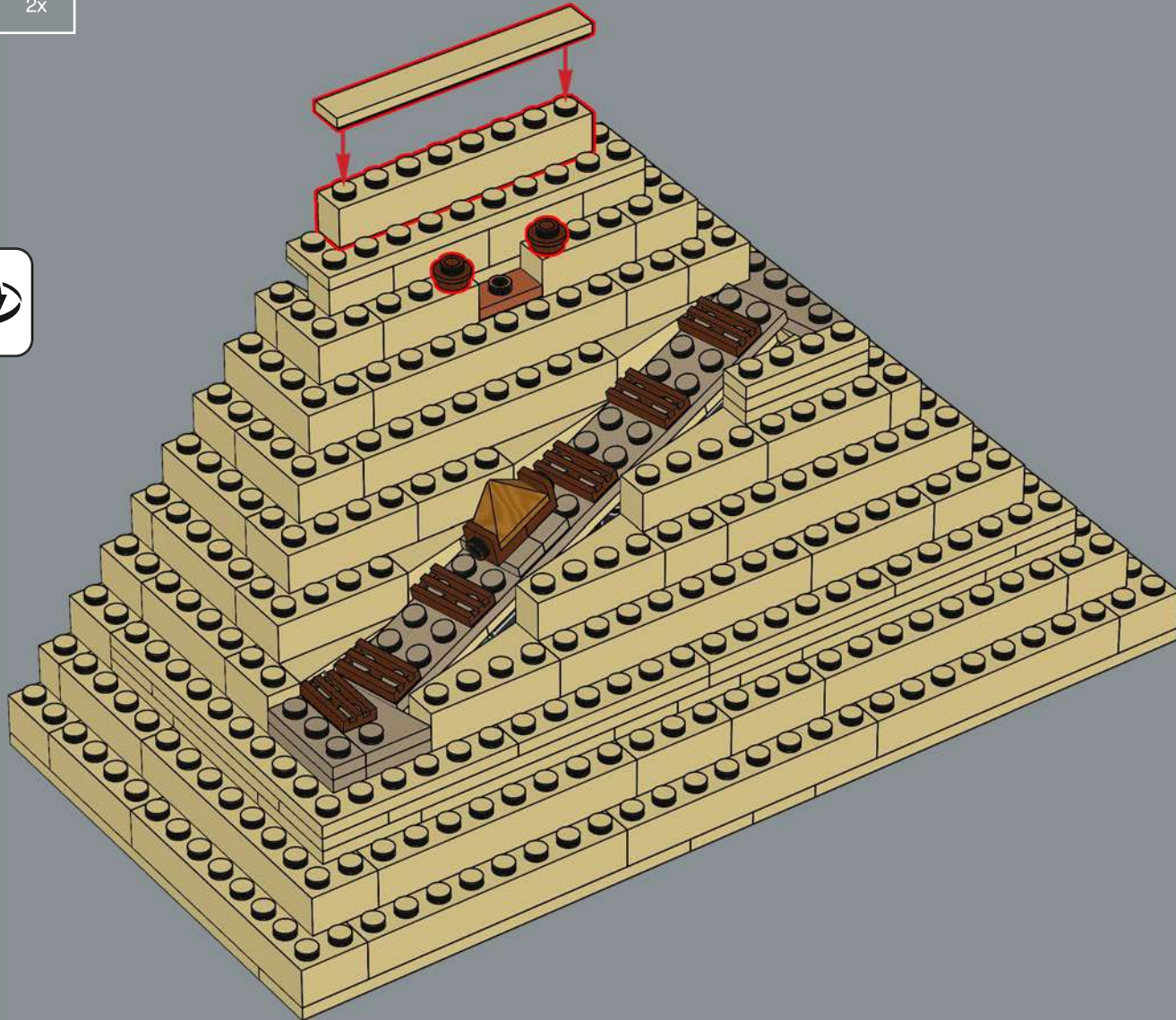

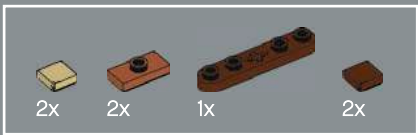

127

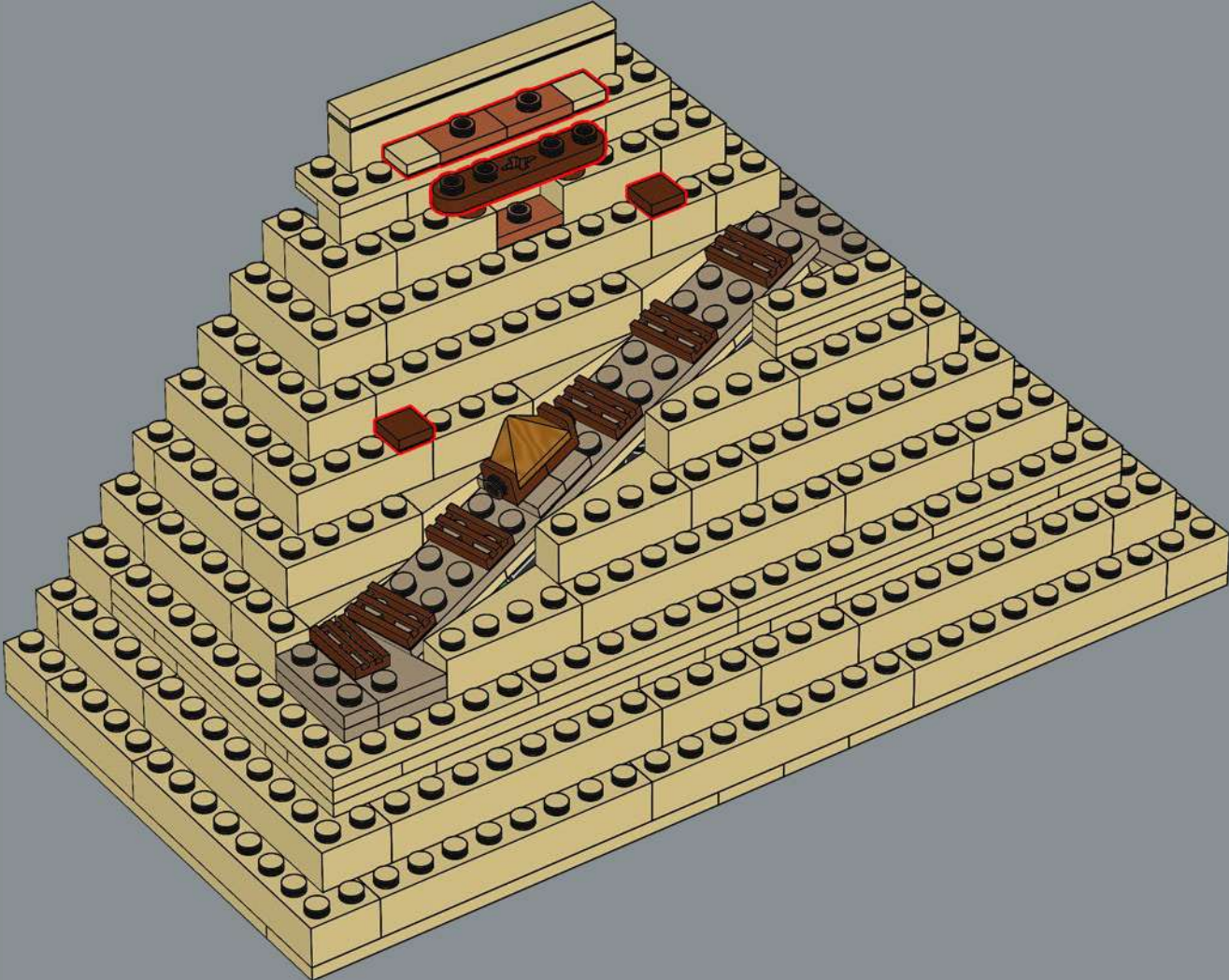

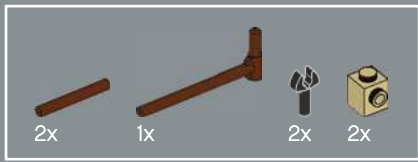

128

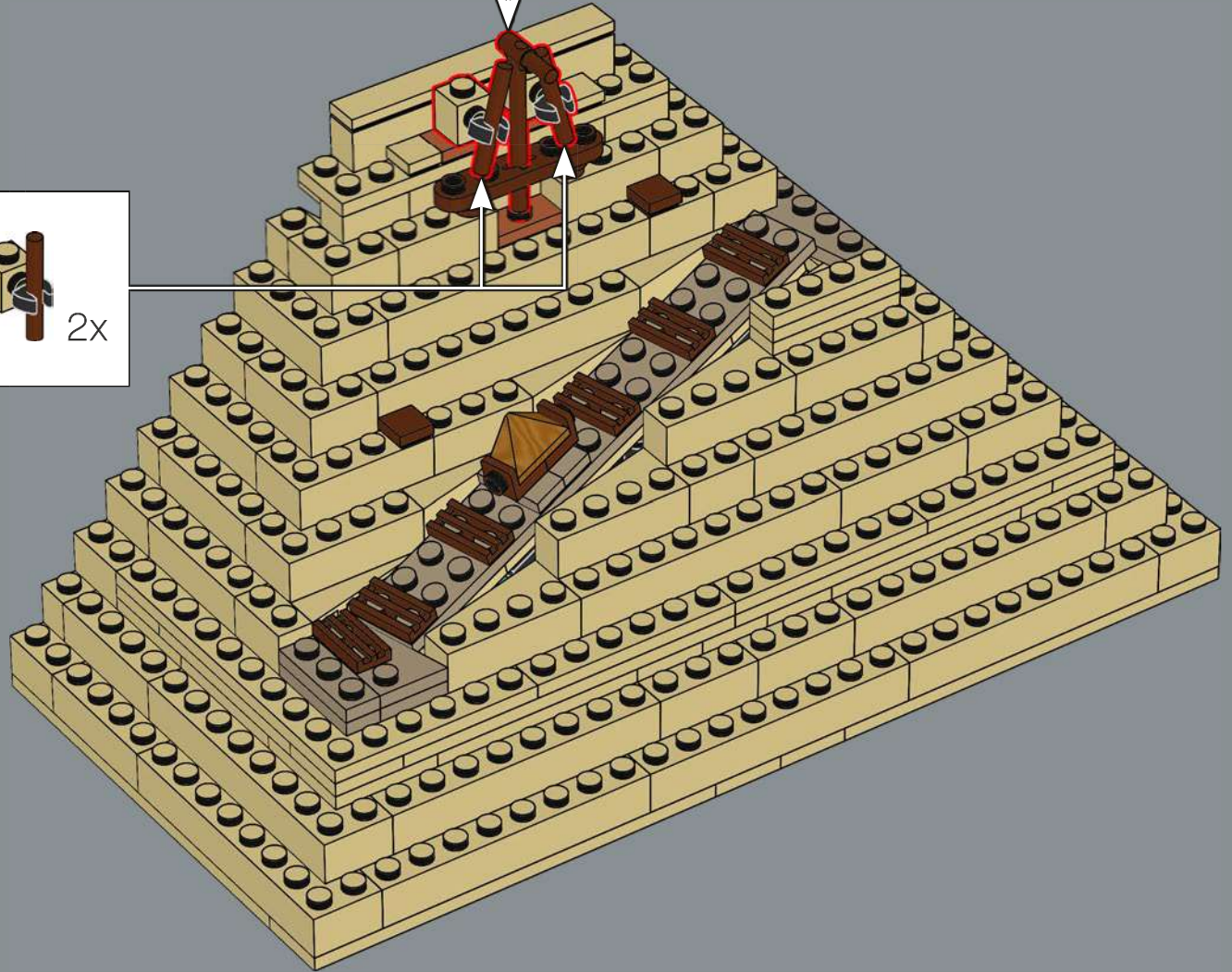
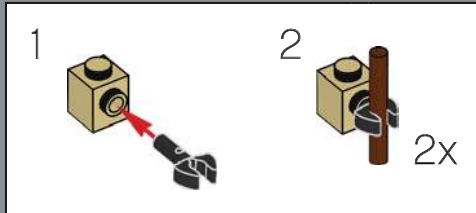



129

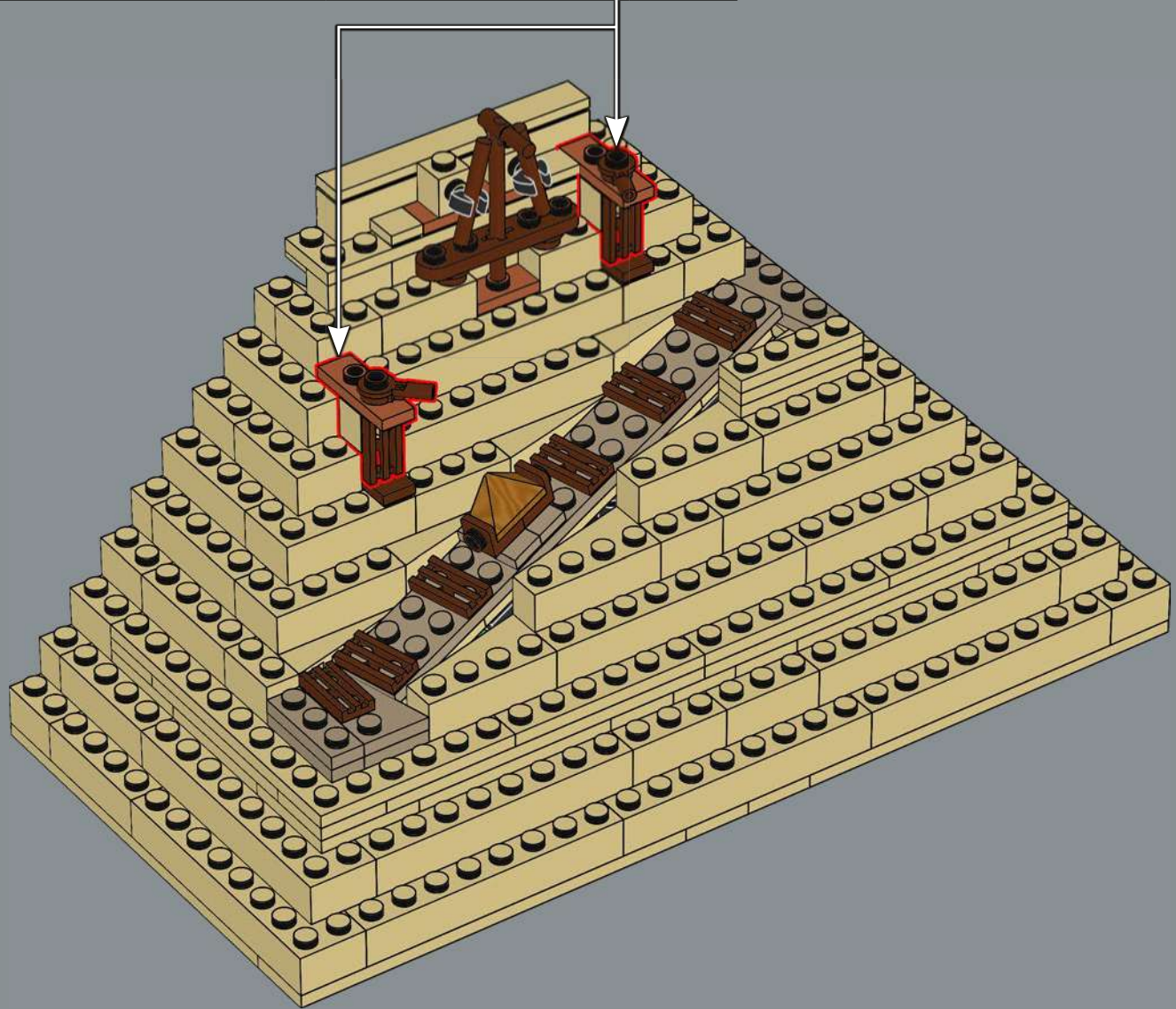
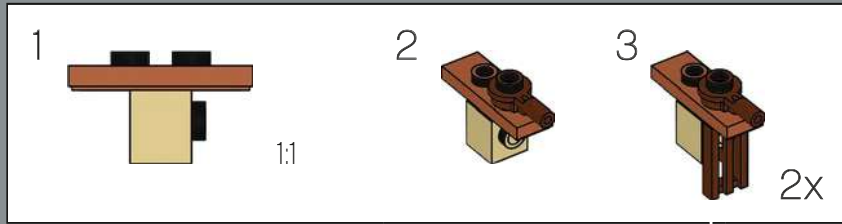

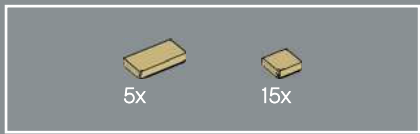

130

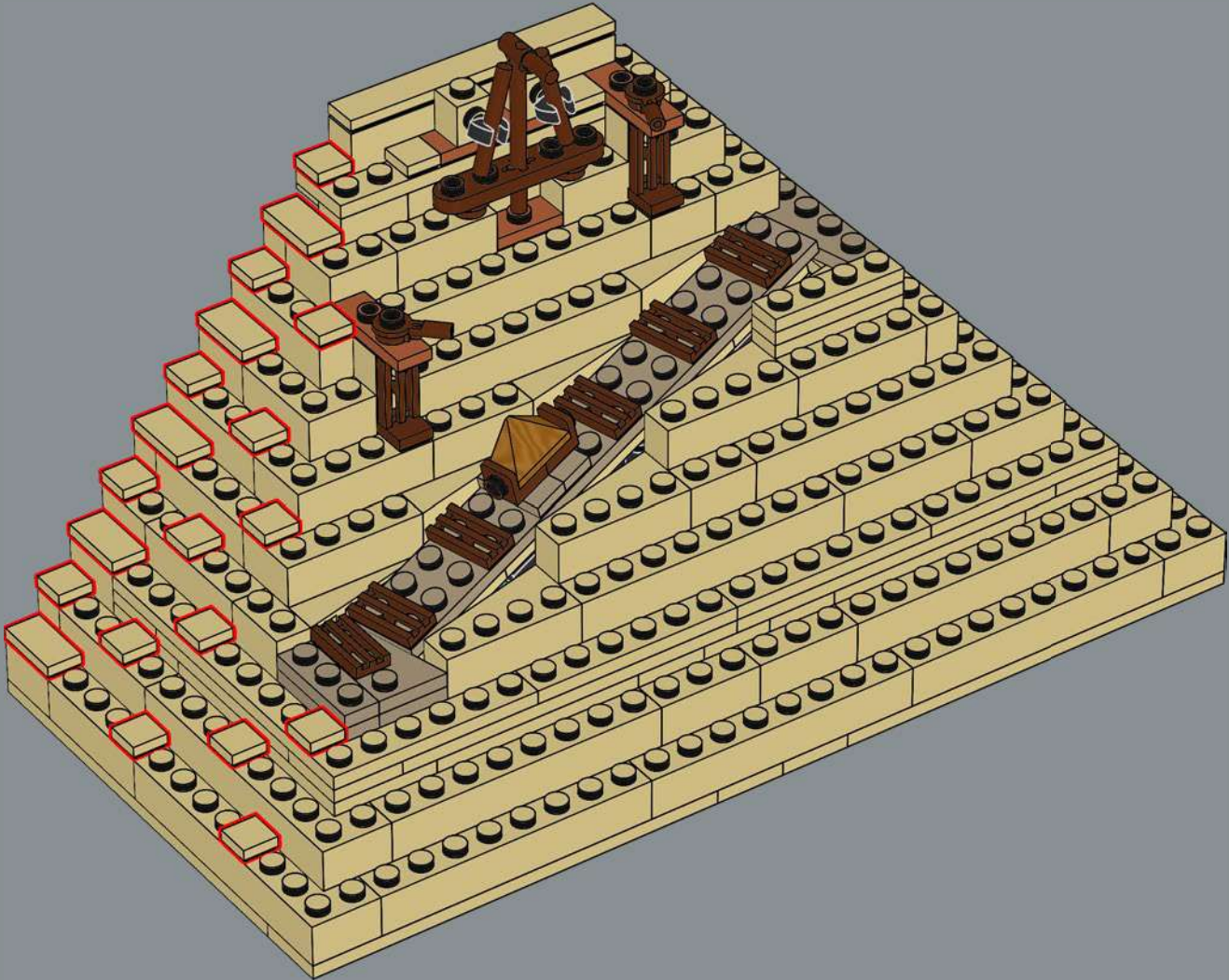



22x

131

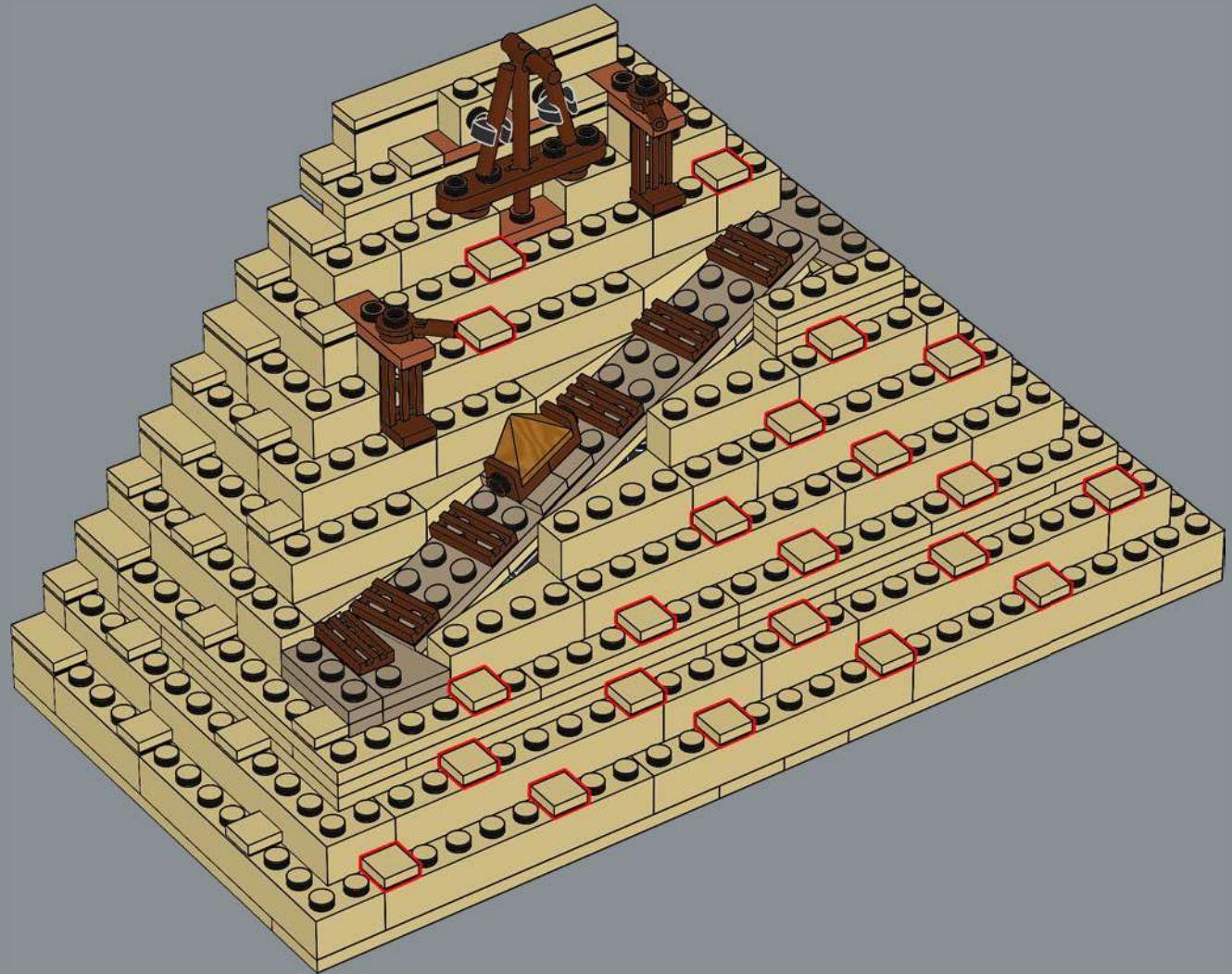

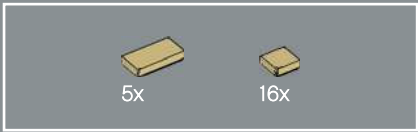

132

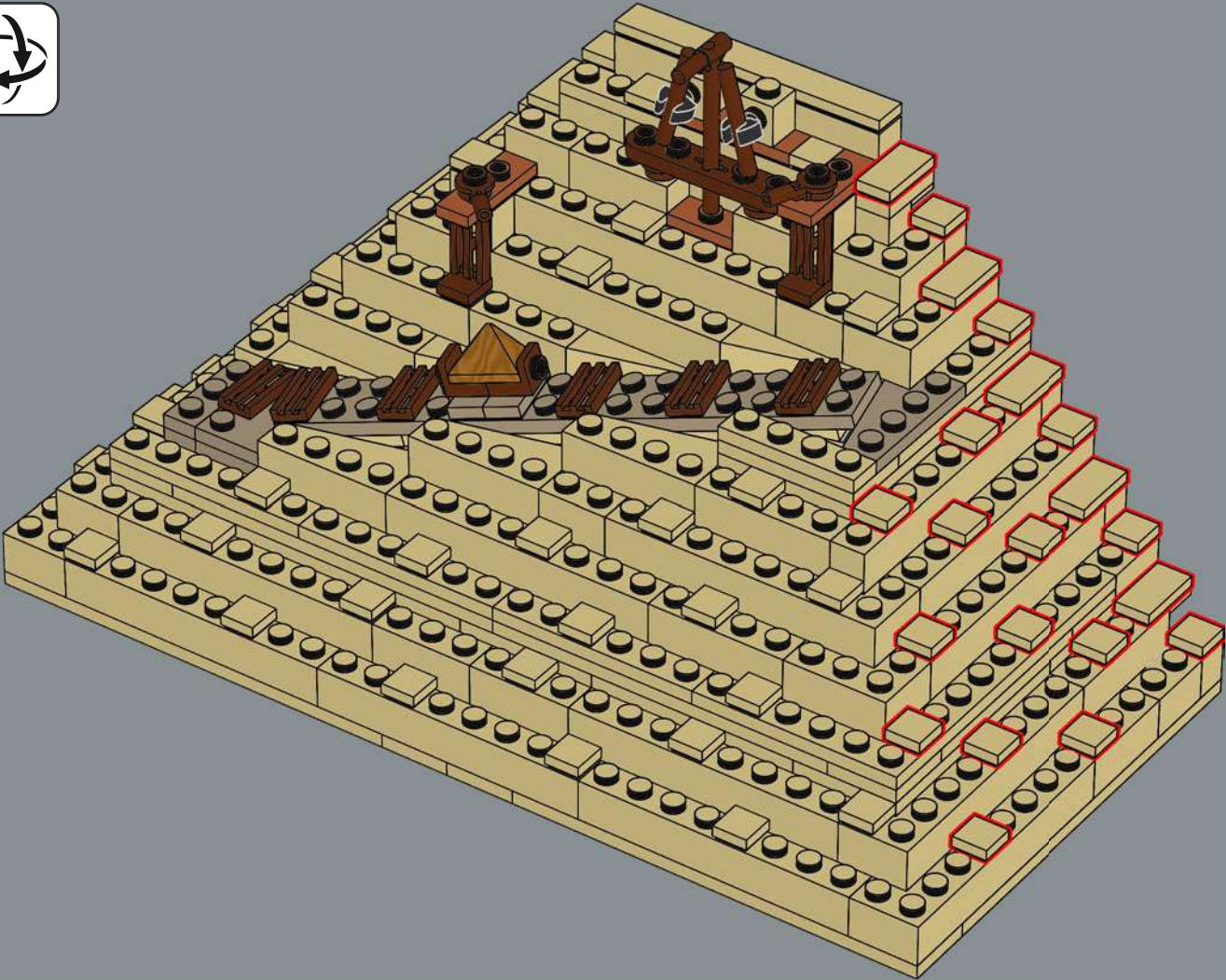

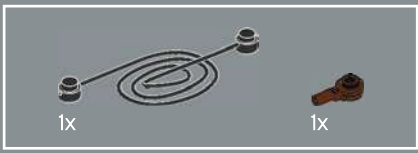

133

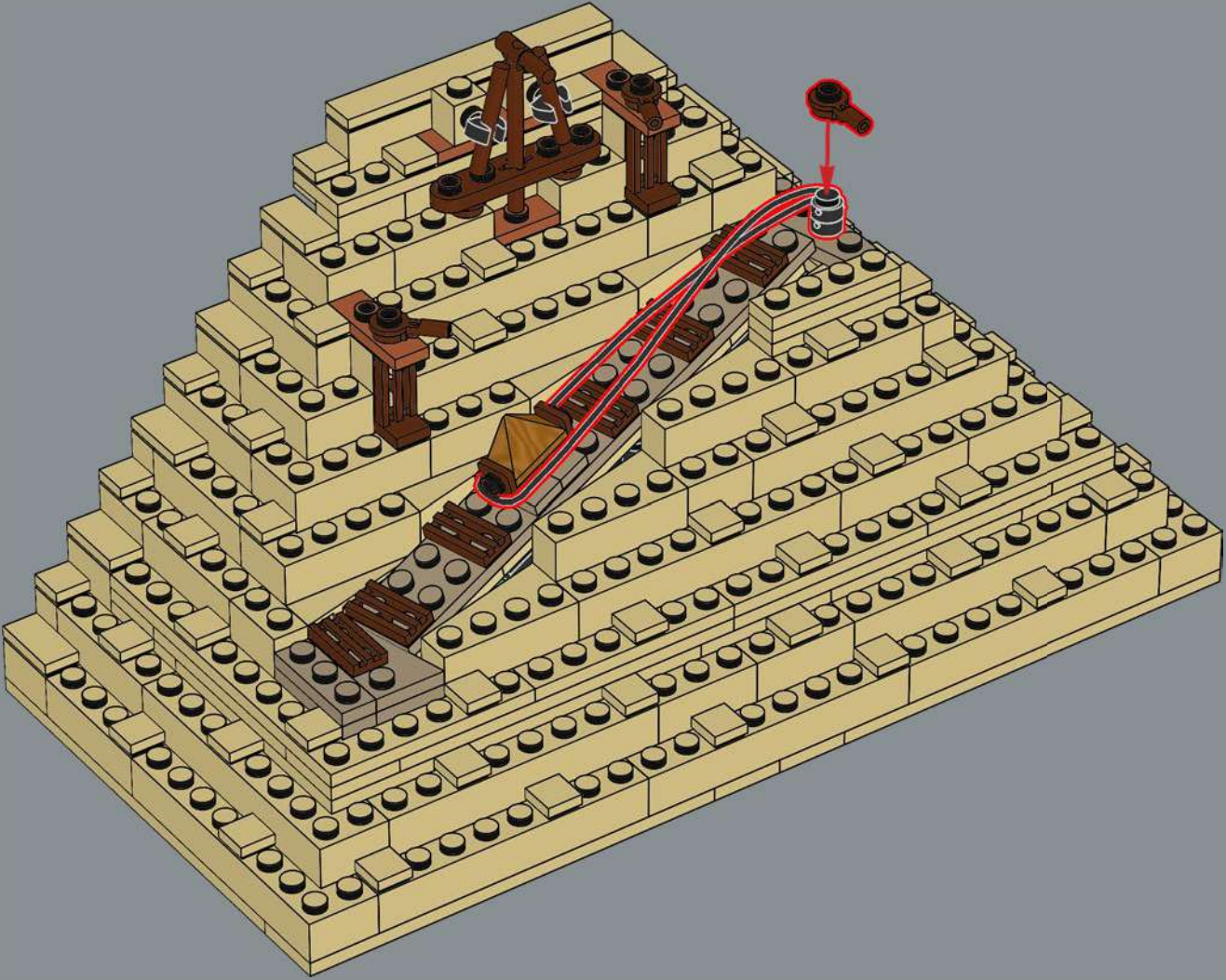

The base of the Pyramid is about 230.3 m (755.6 ft.) on each side, which gives a volume of approx. 2.6 million cubic meters (92 million cubic feet).

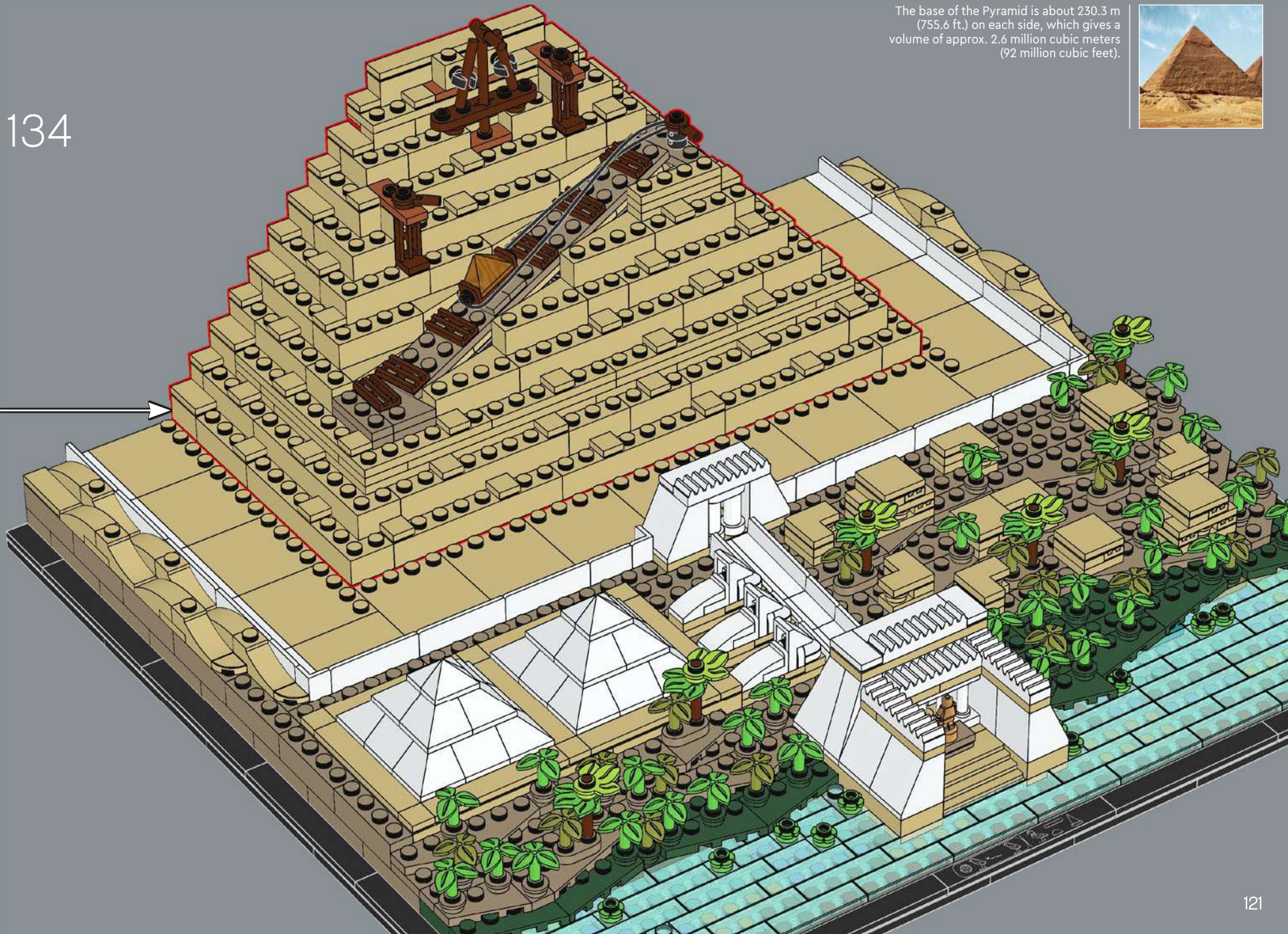

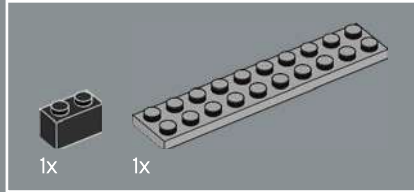
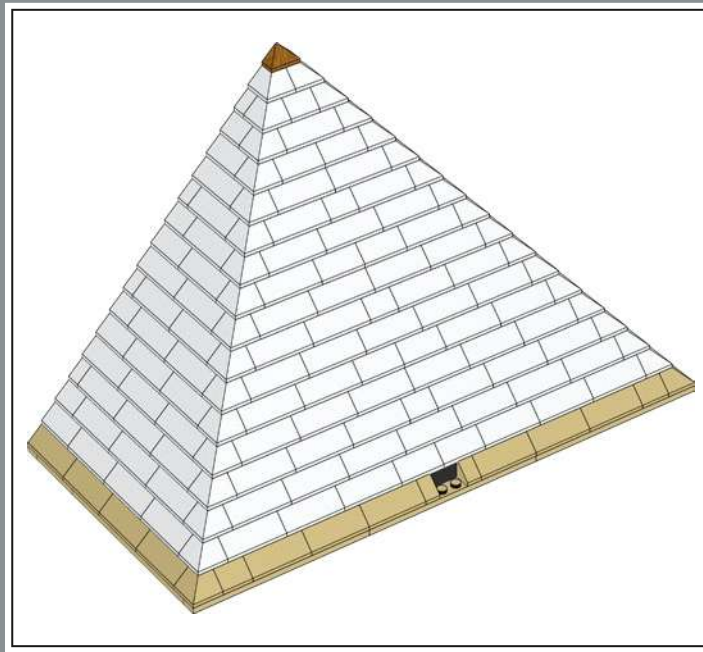

135

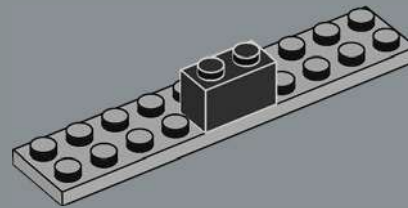



136

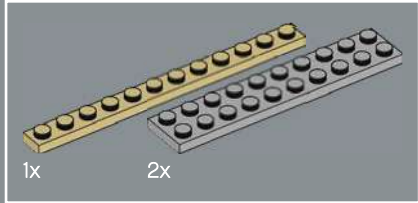
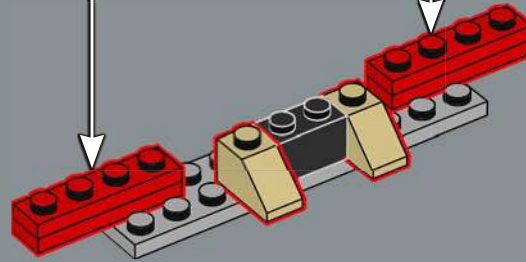
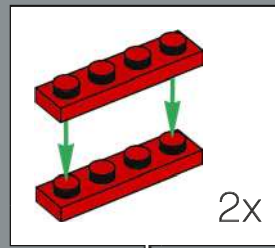

137

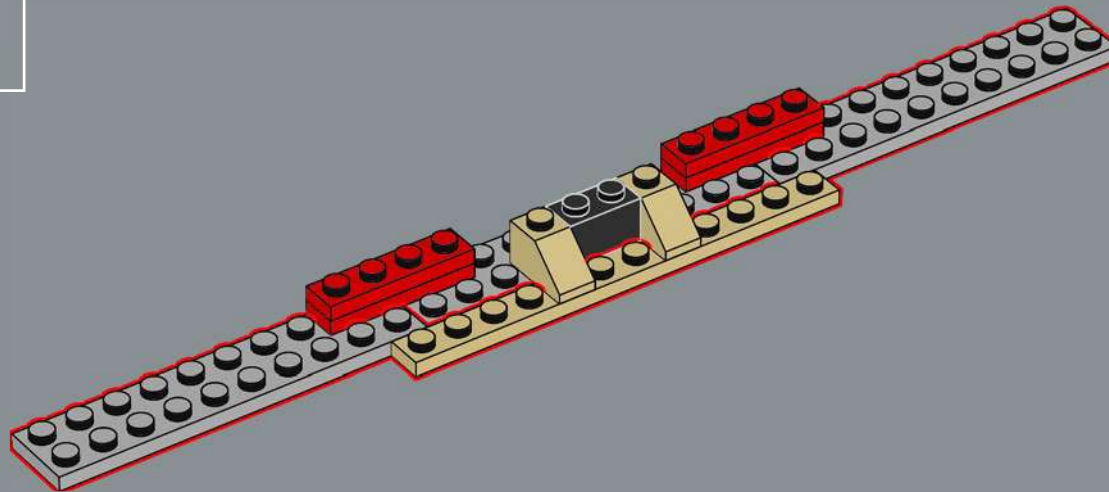

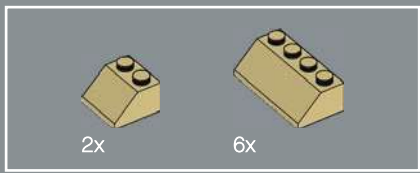

138

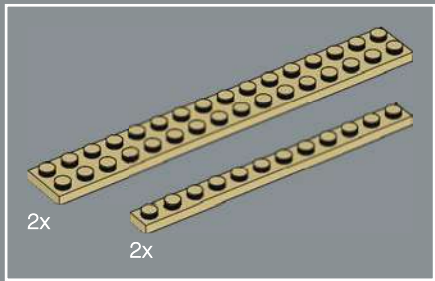
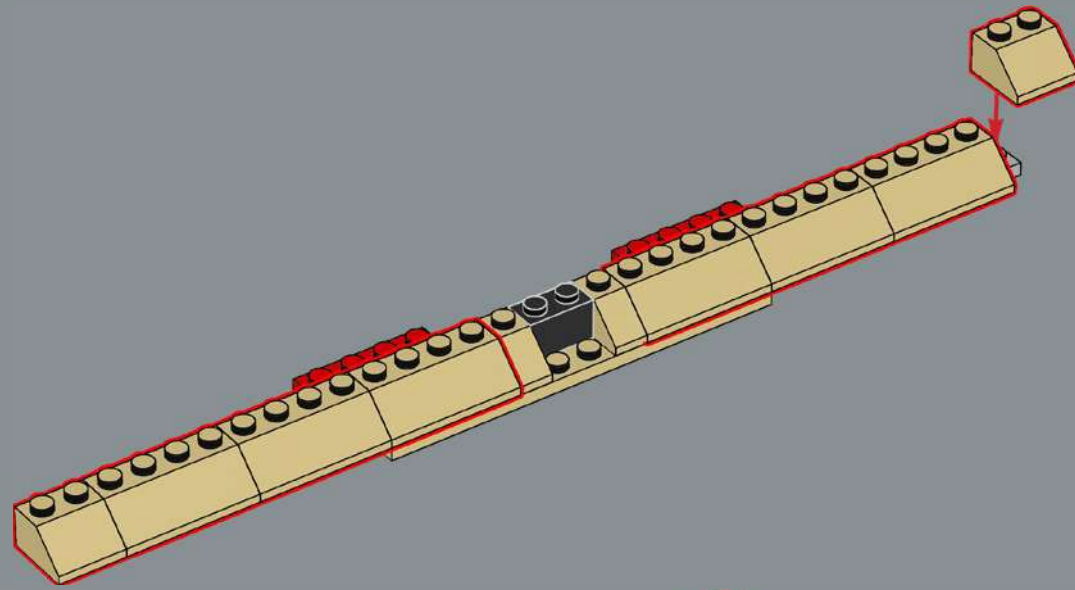

139

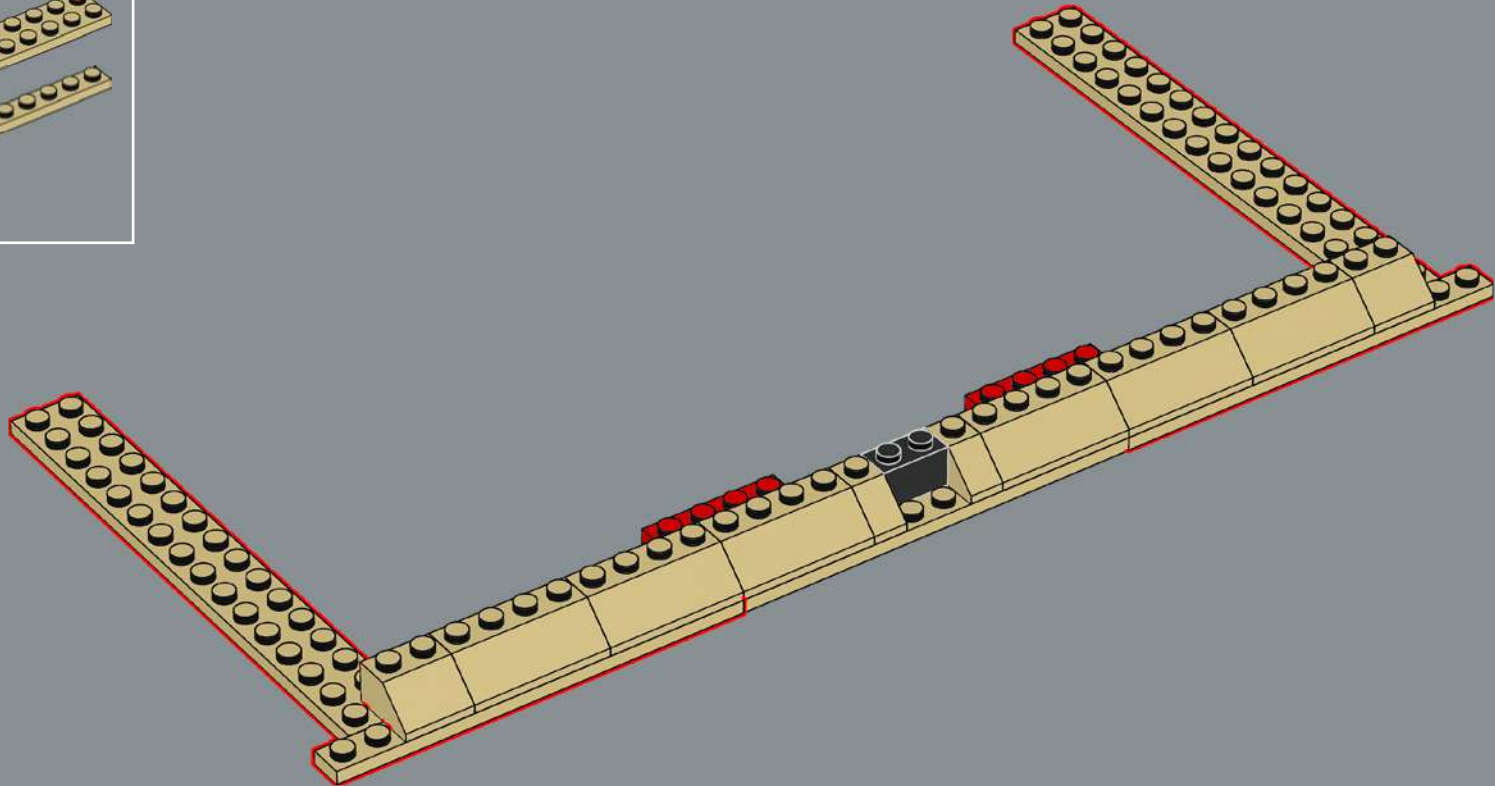

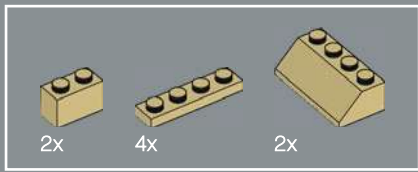

140

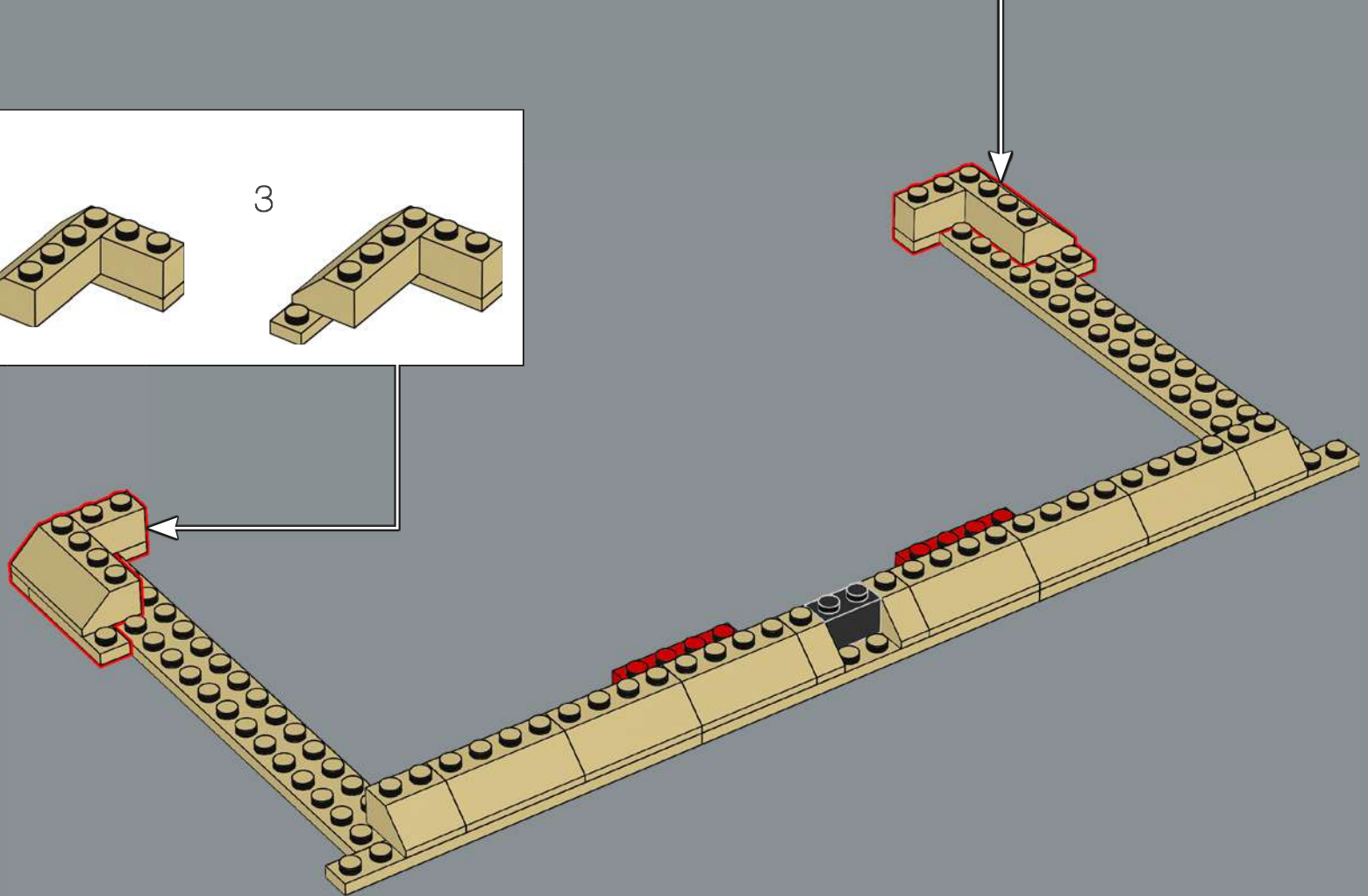
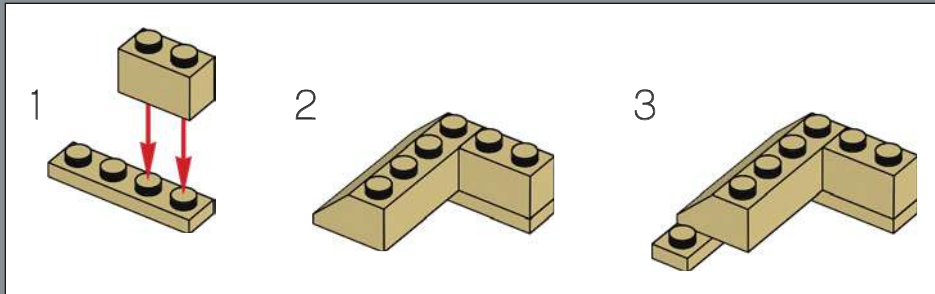
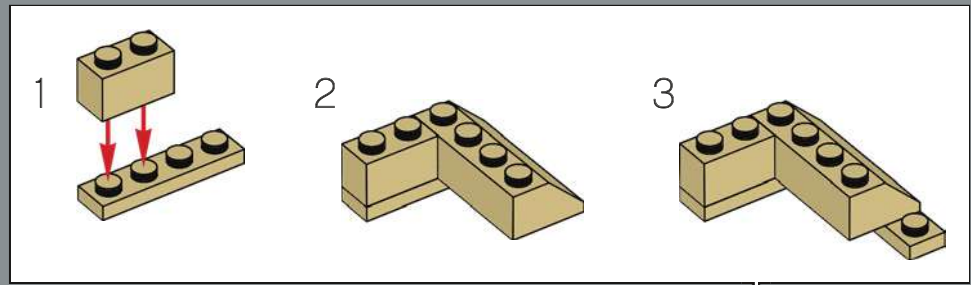

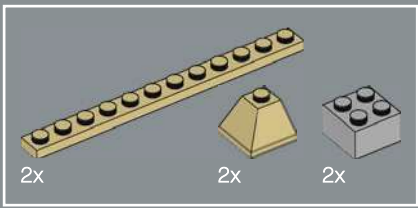

141

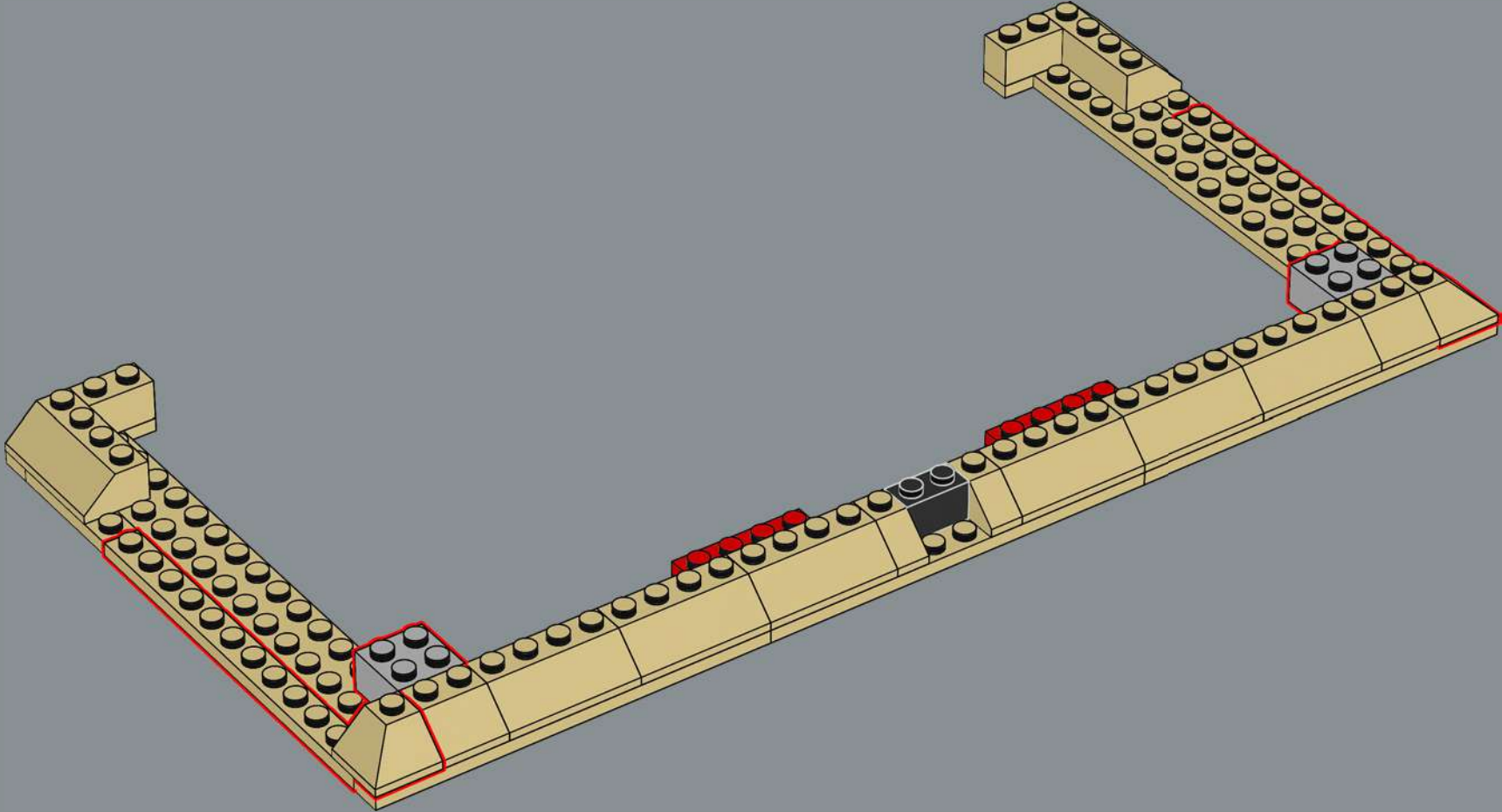

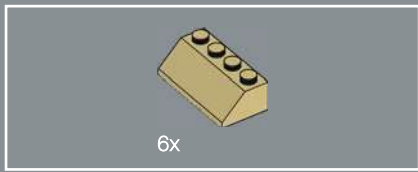

142

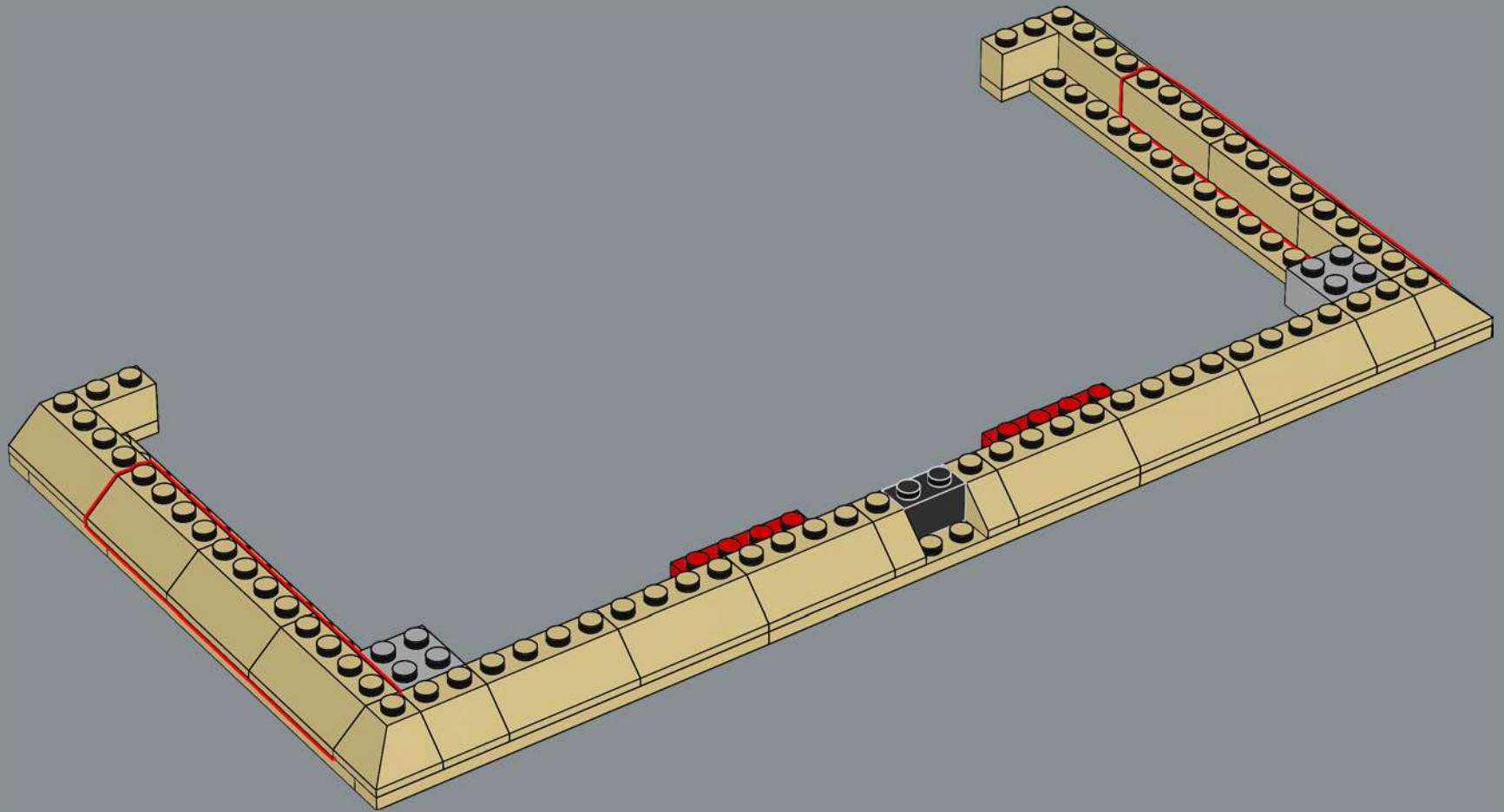

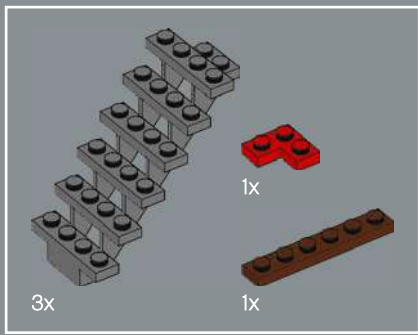

143

The LEGO® element used to support the shell of the Pyramid is more commonly used as a staircase for LEGO minifigures.



1

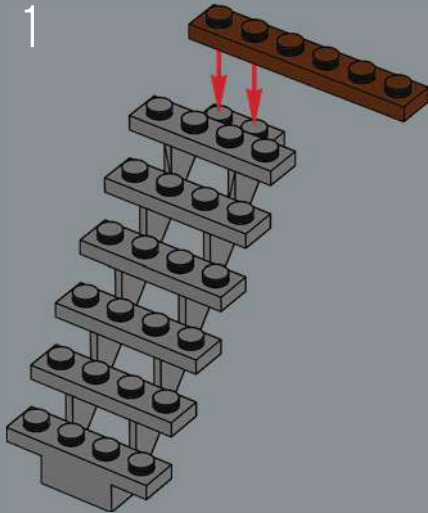

2

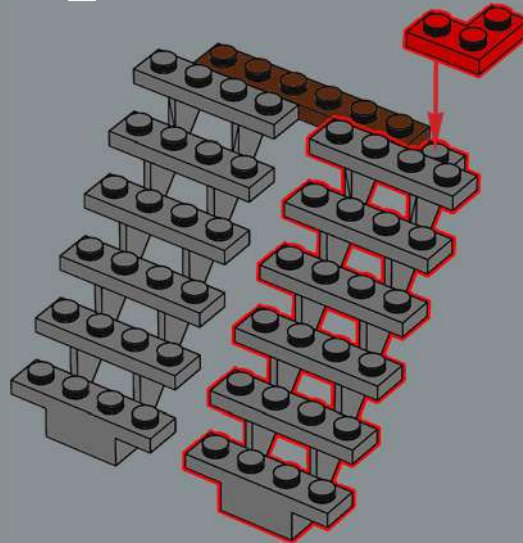

3

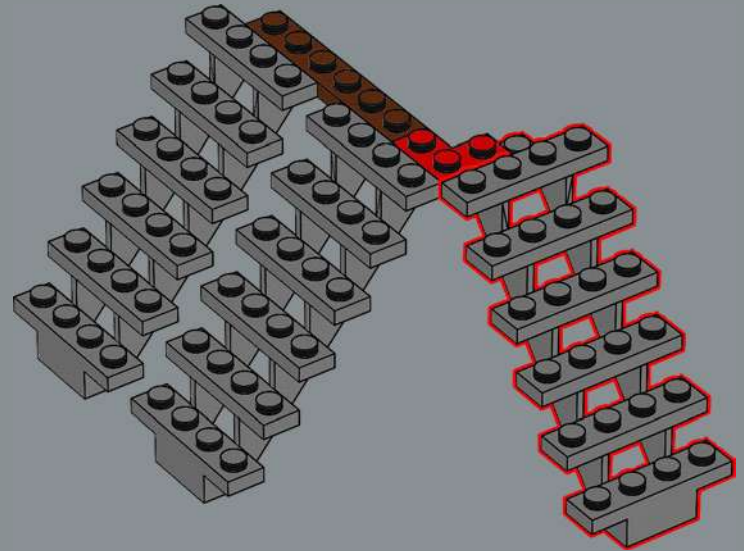

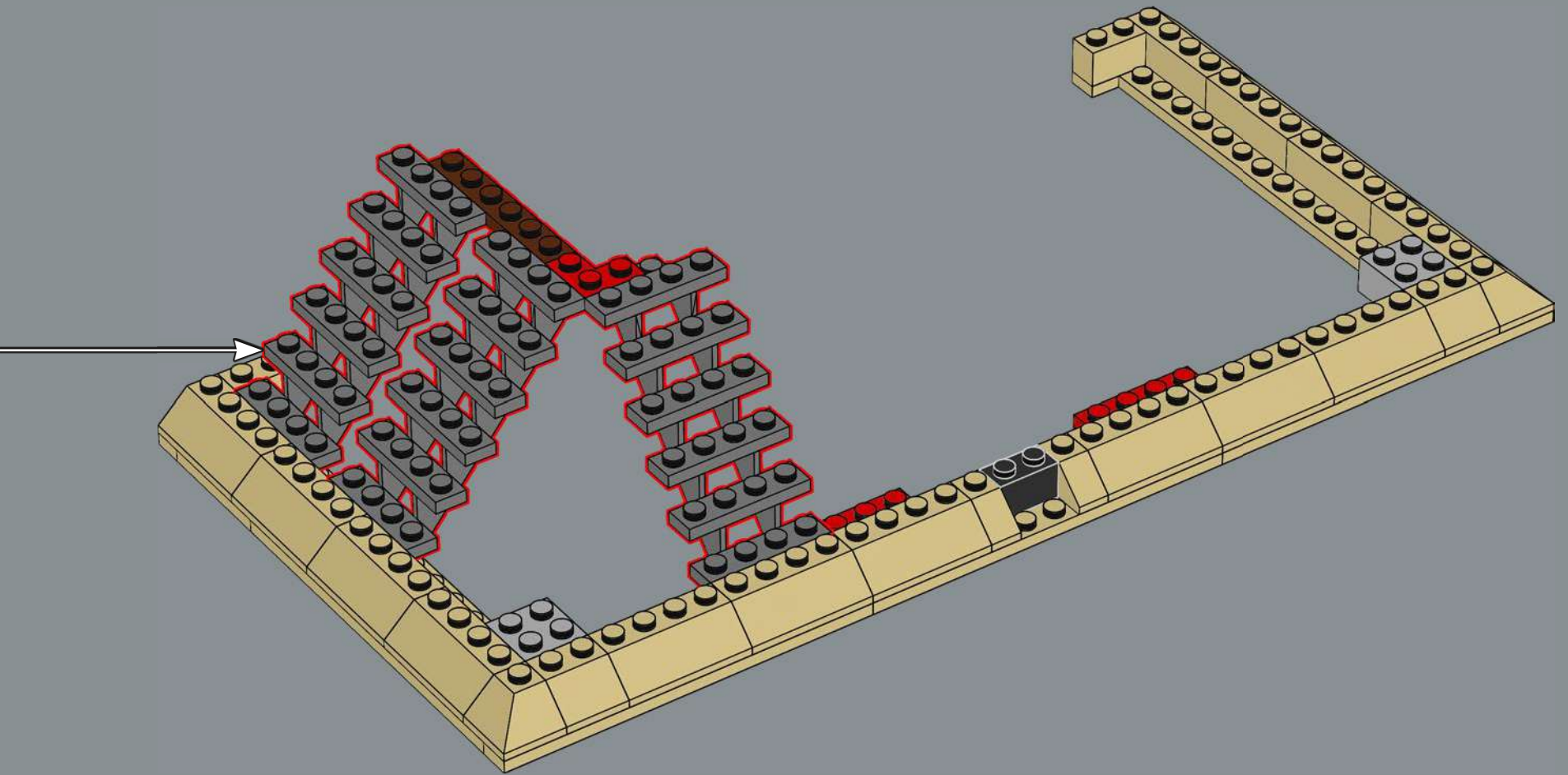

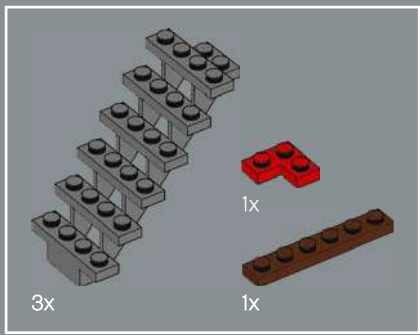

144

1

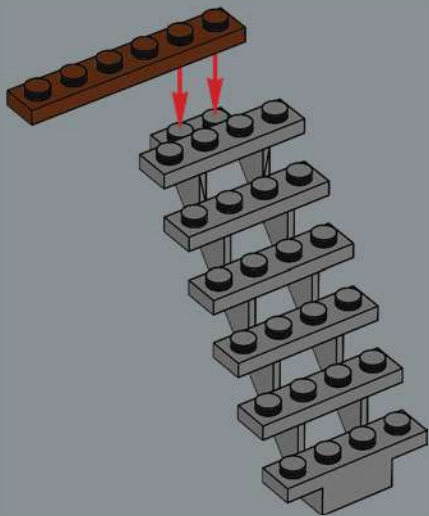

2

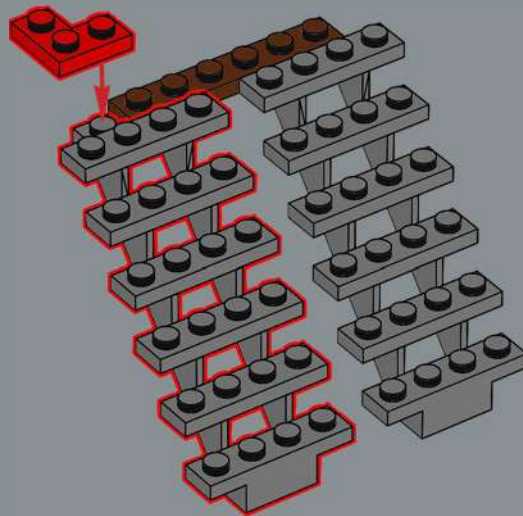

3

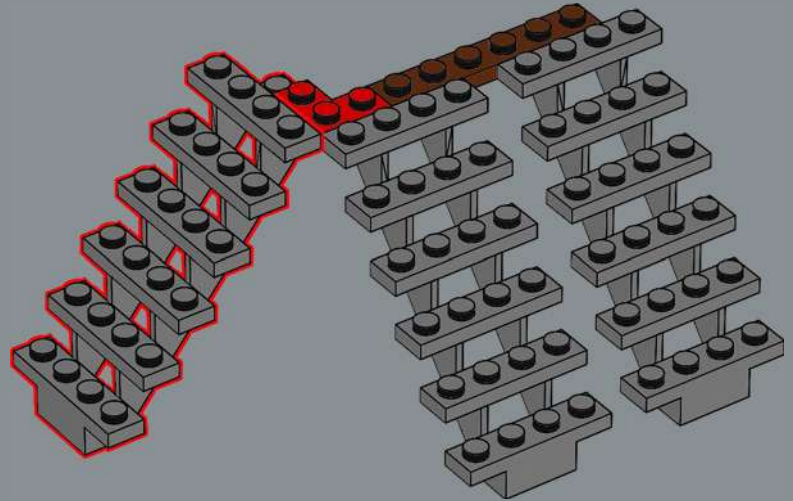

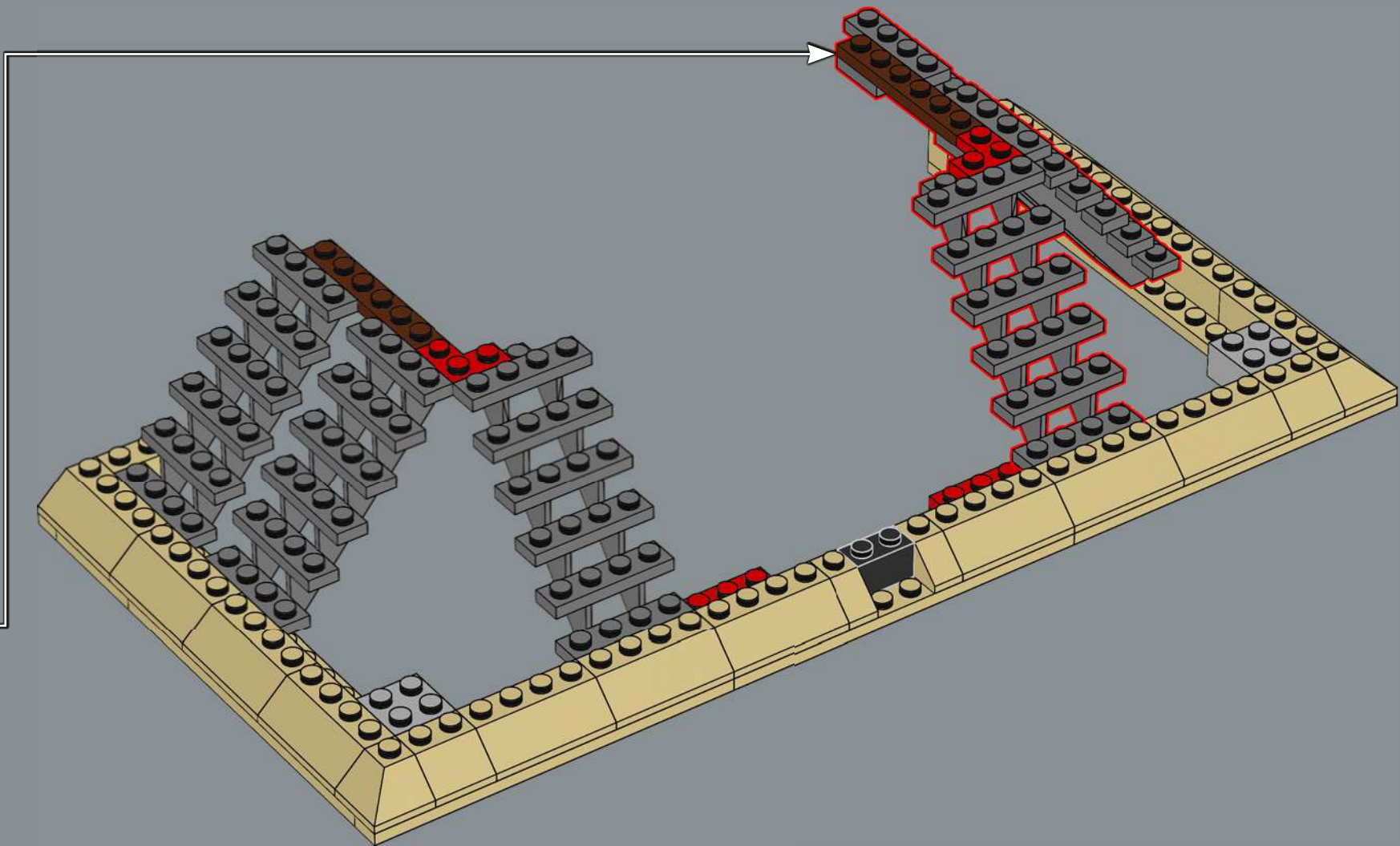

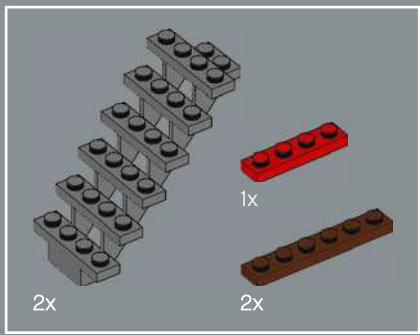

145

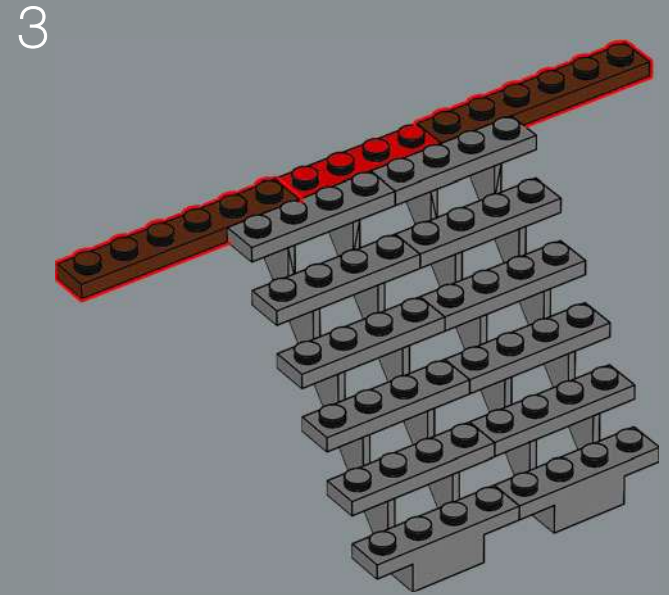
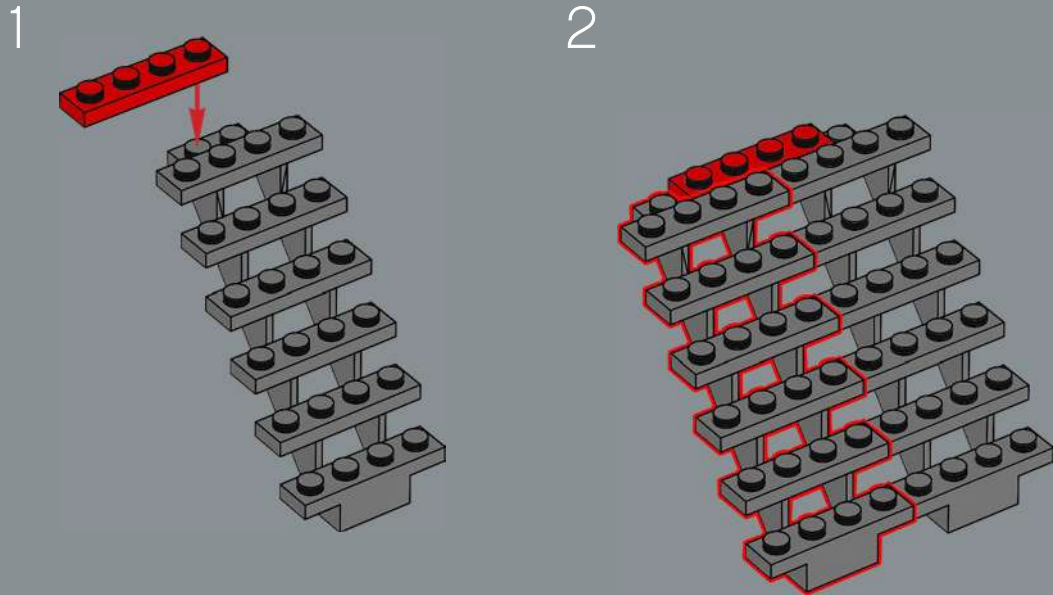

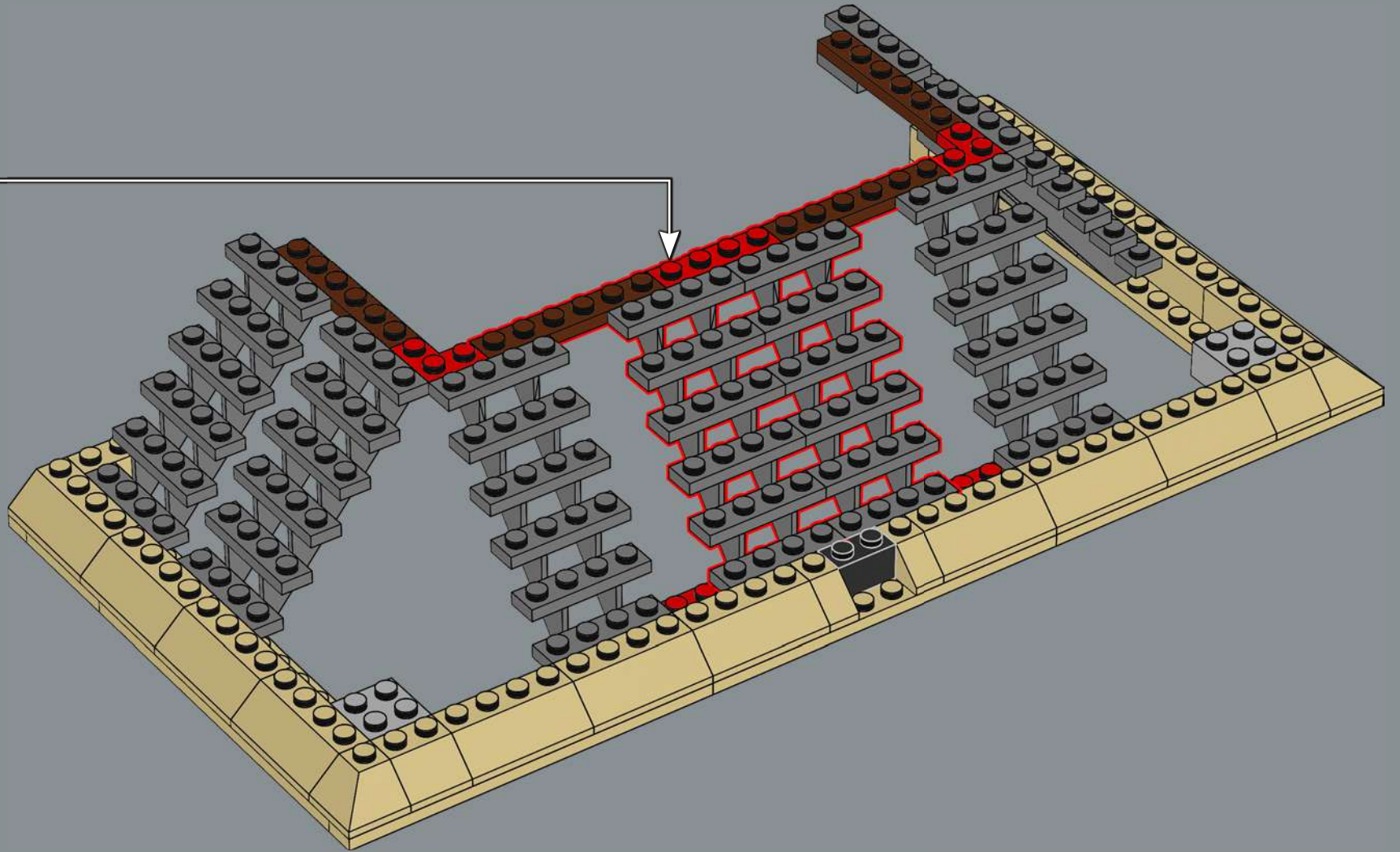

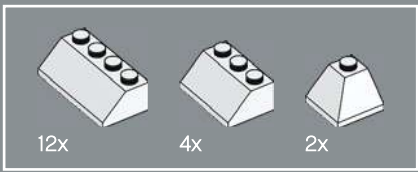

146

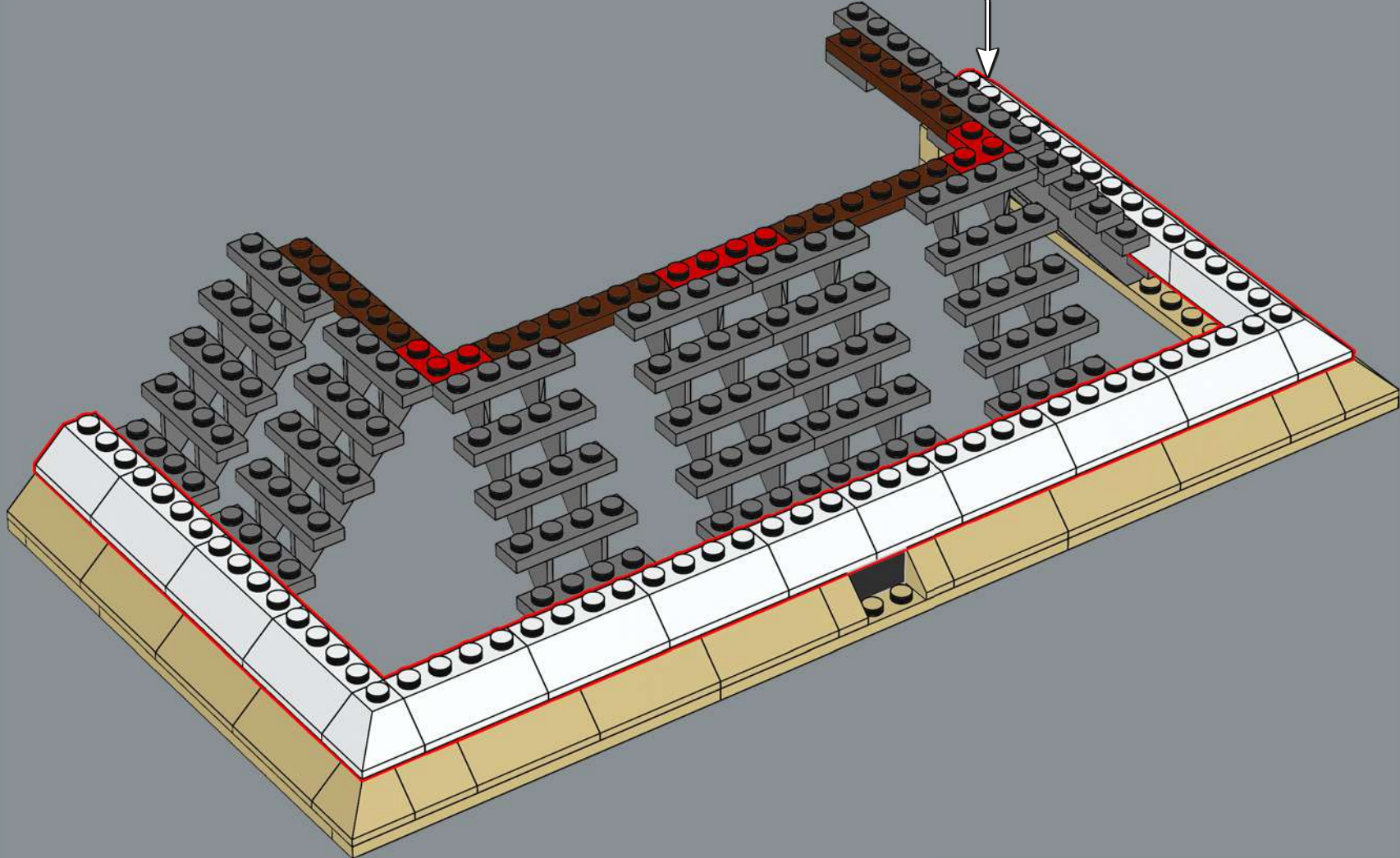
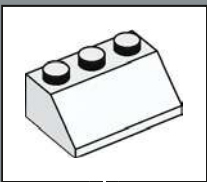

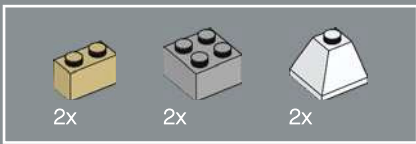

147

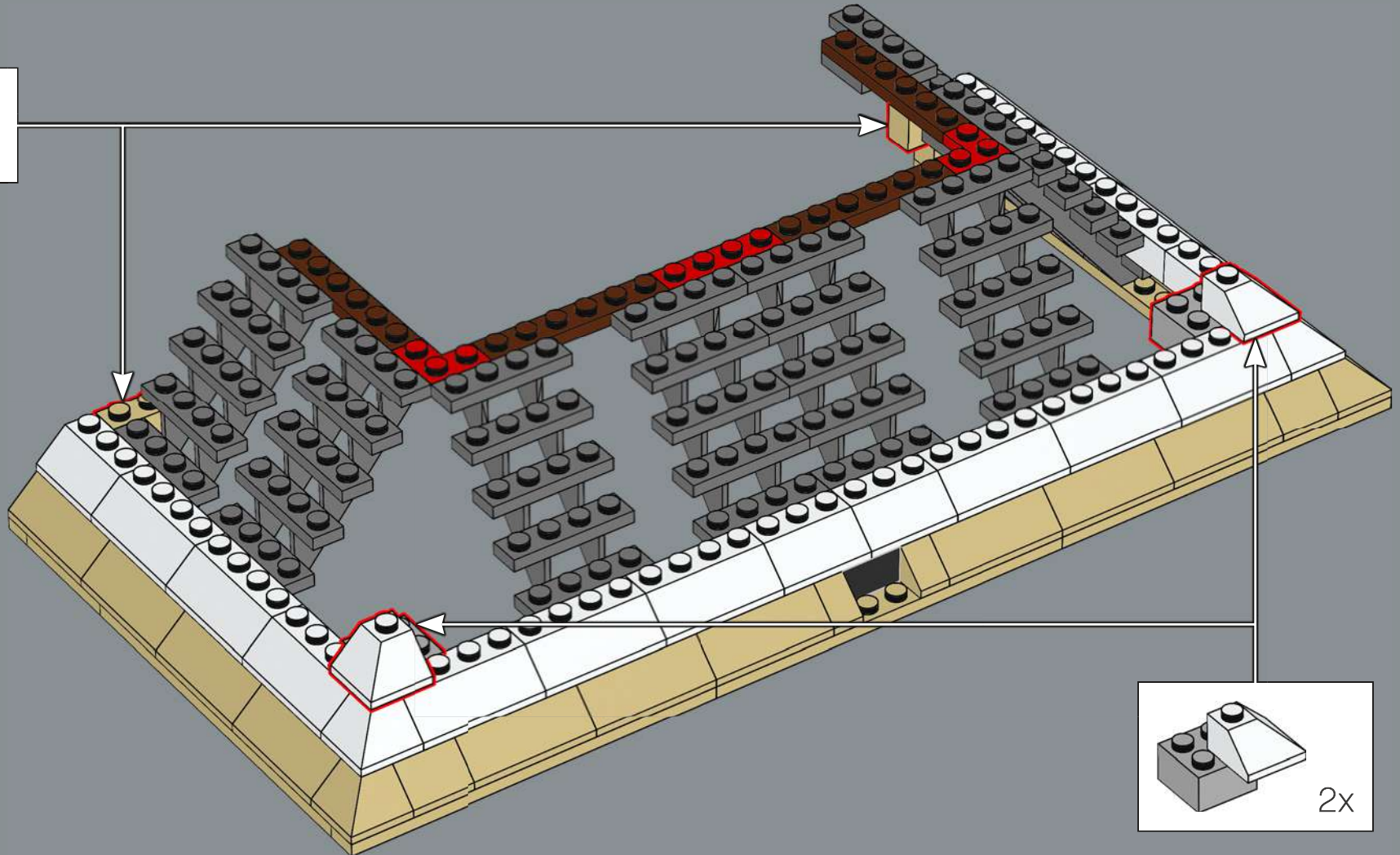
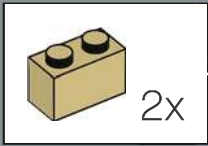

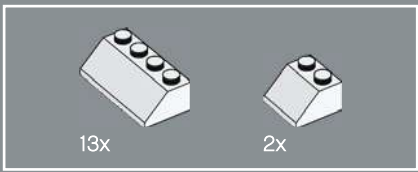

148

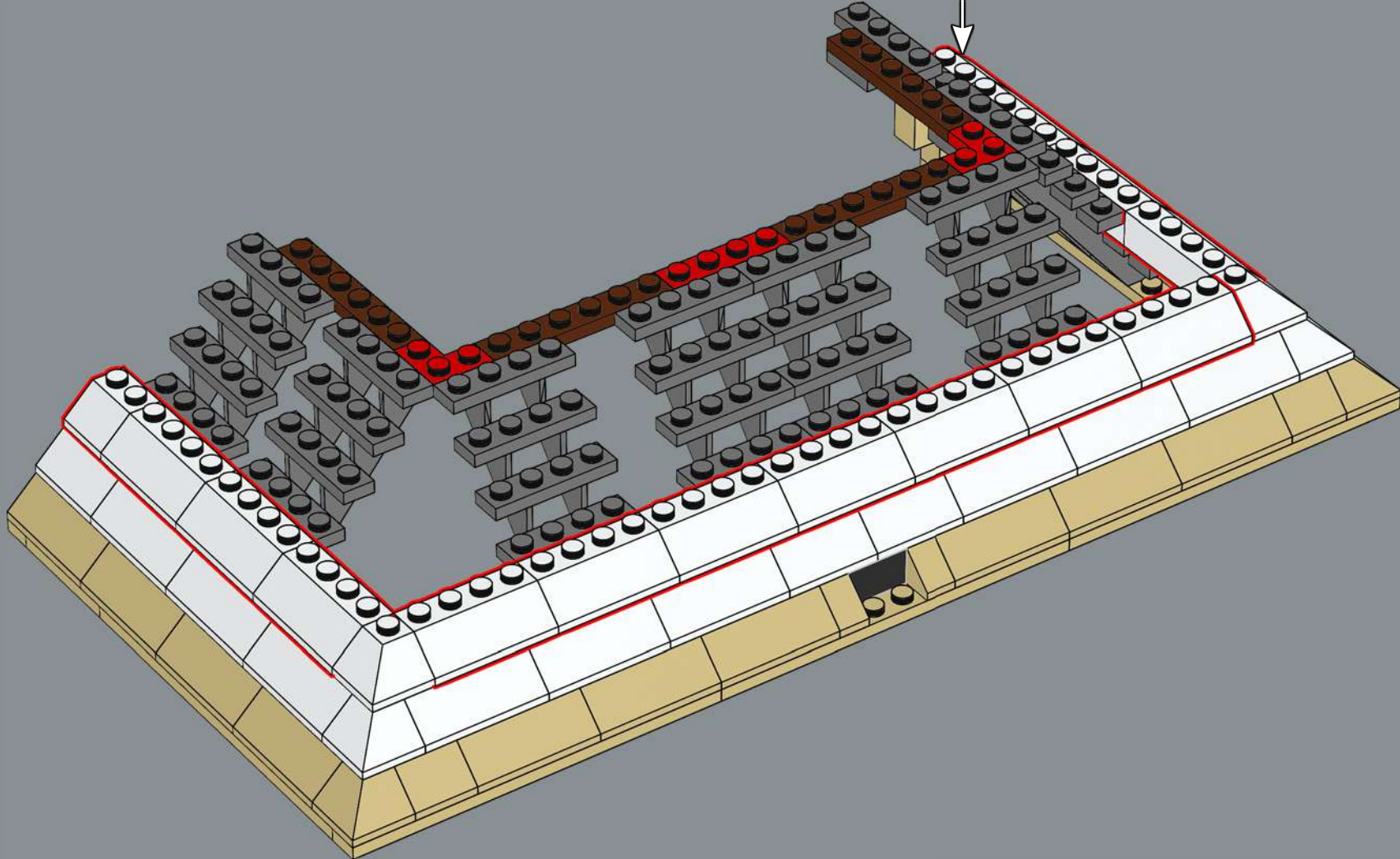
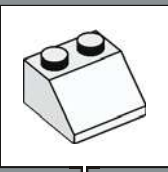

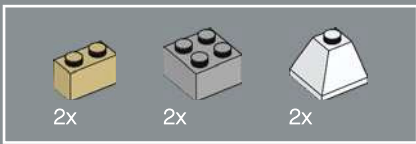

149

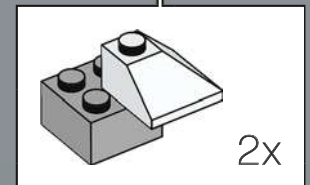
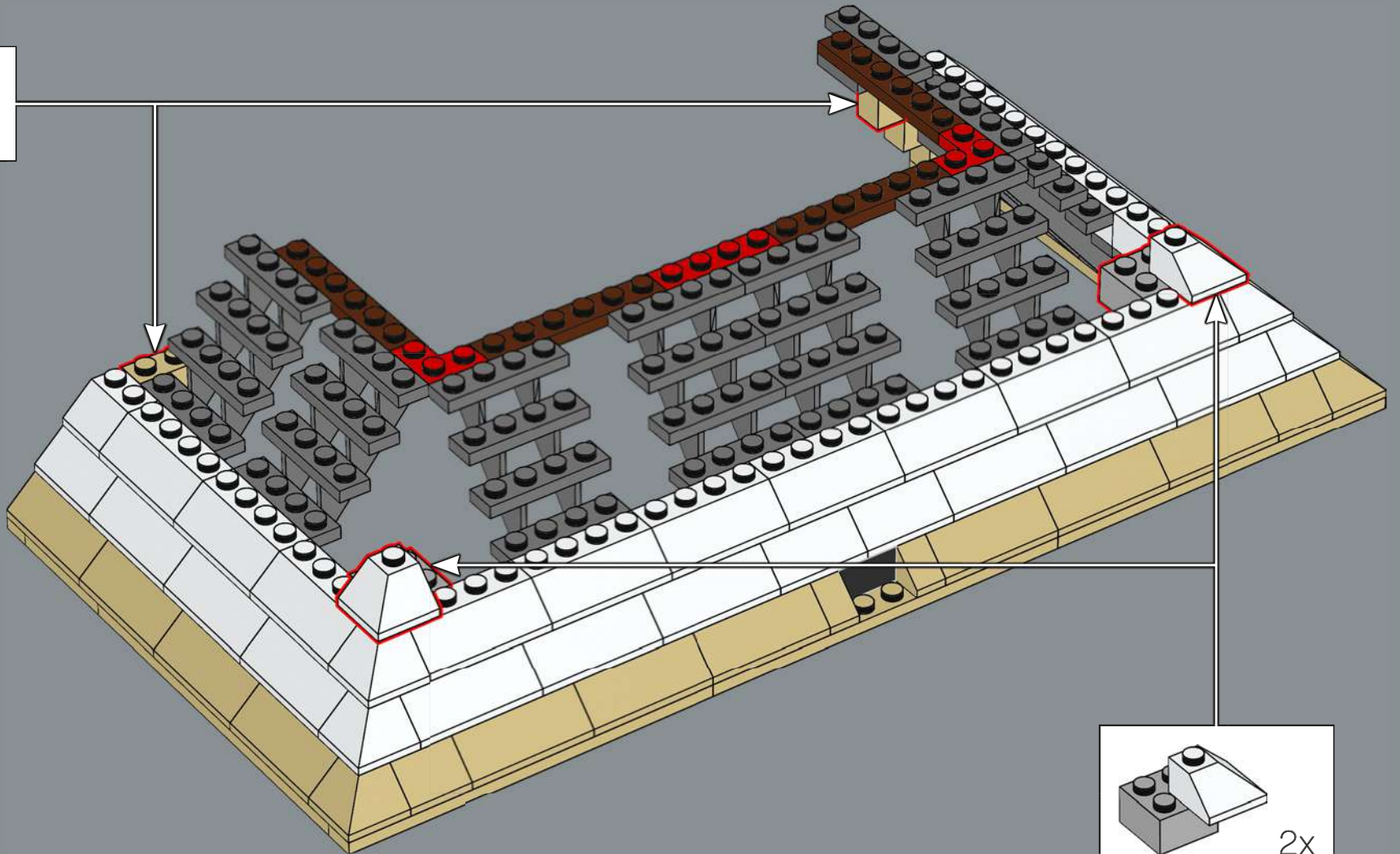
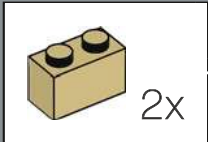

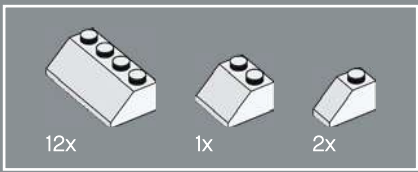

150

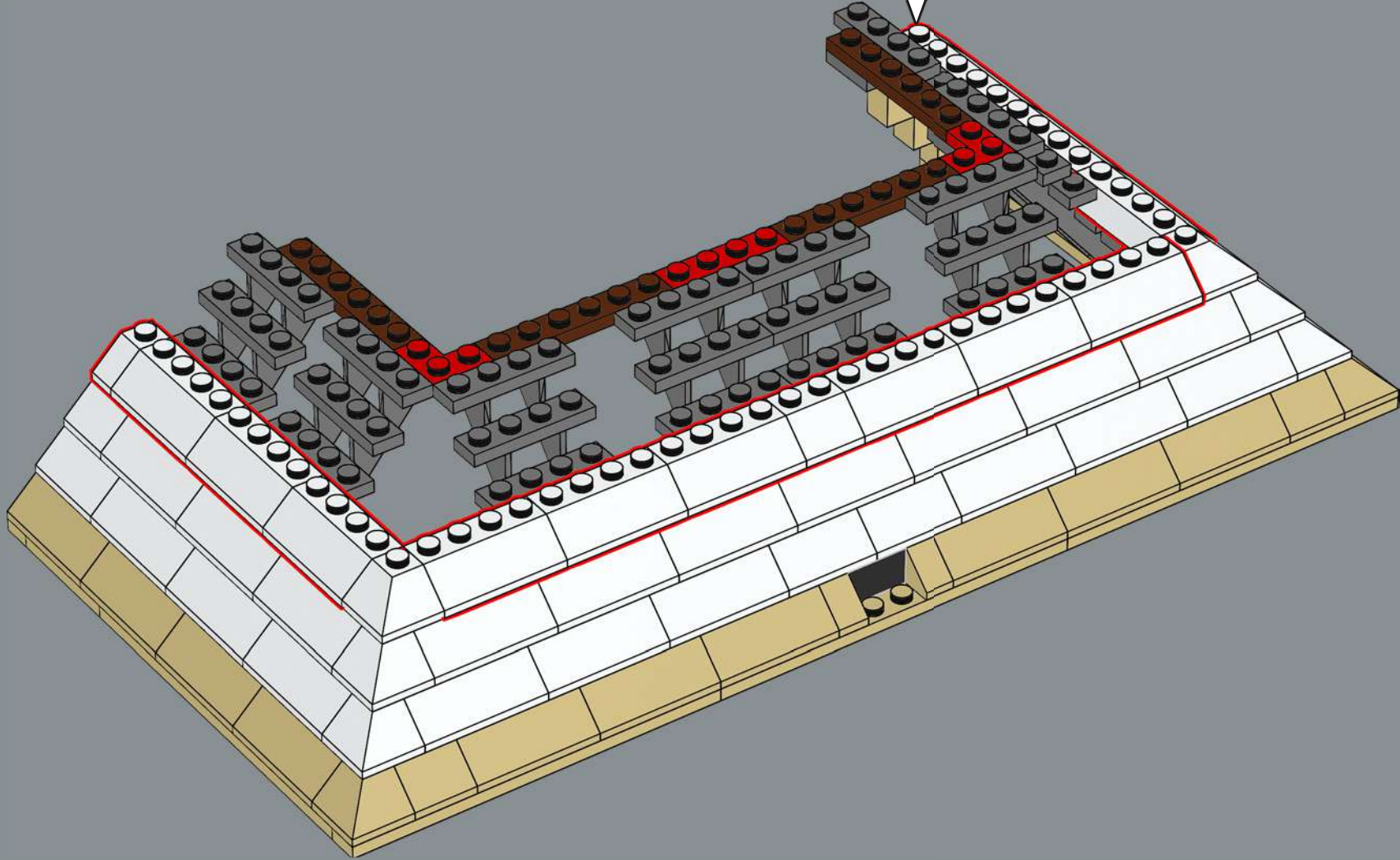

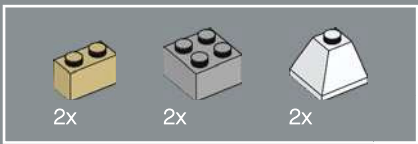

151

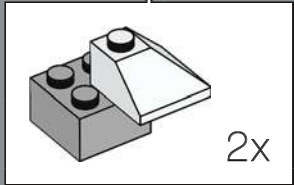
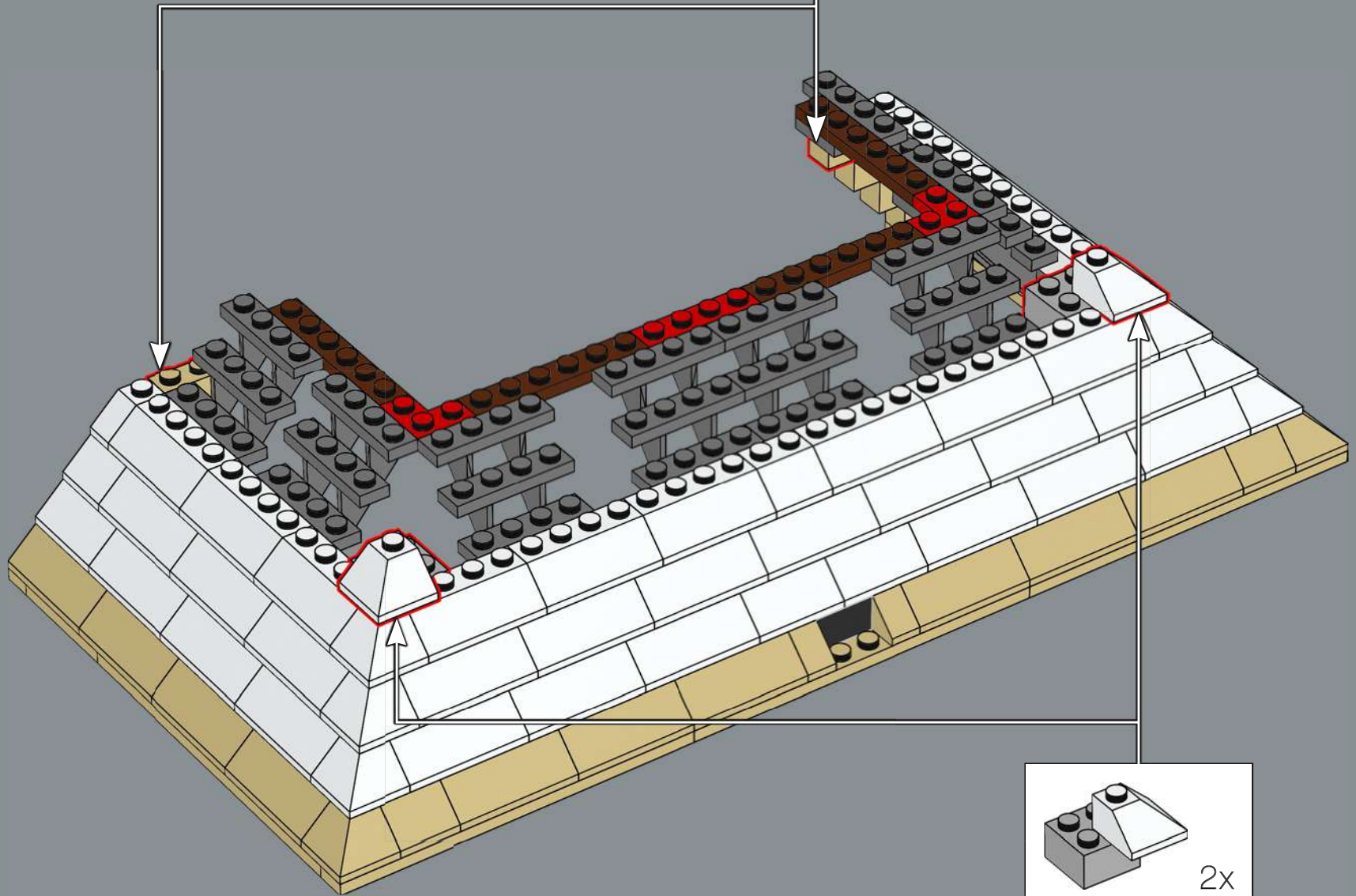

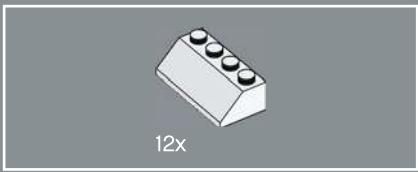

152

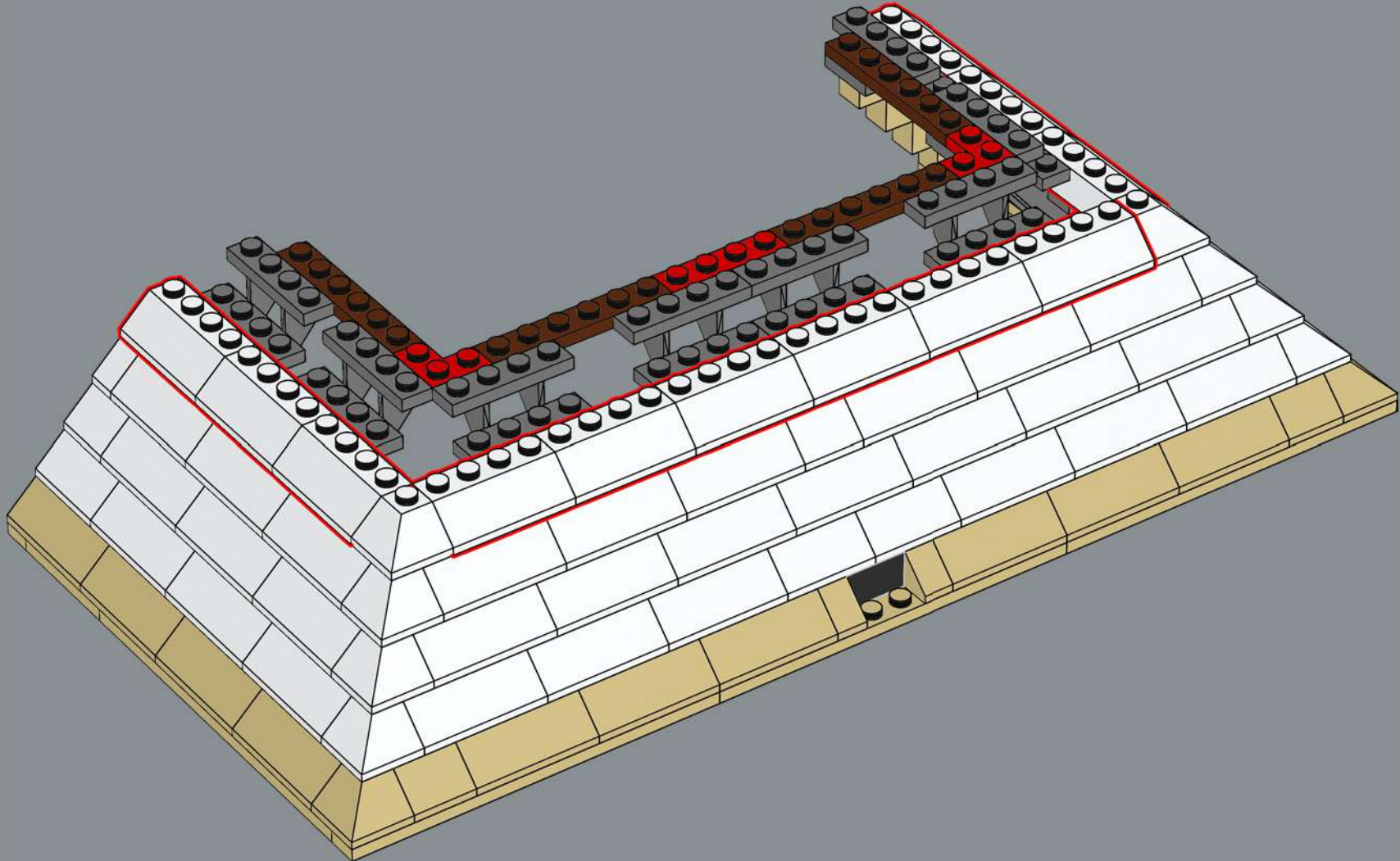

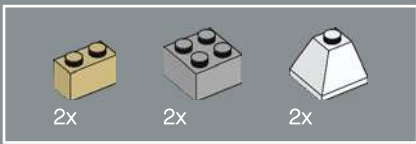

153

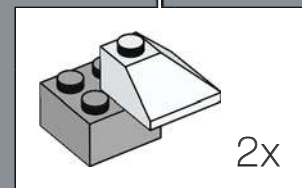
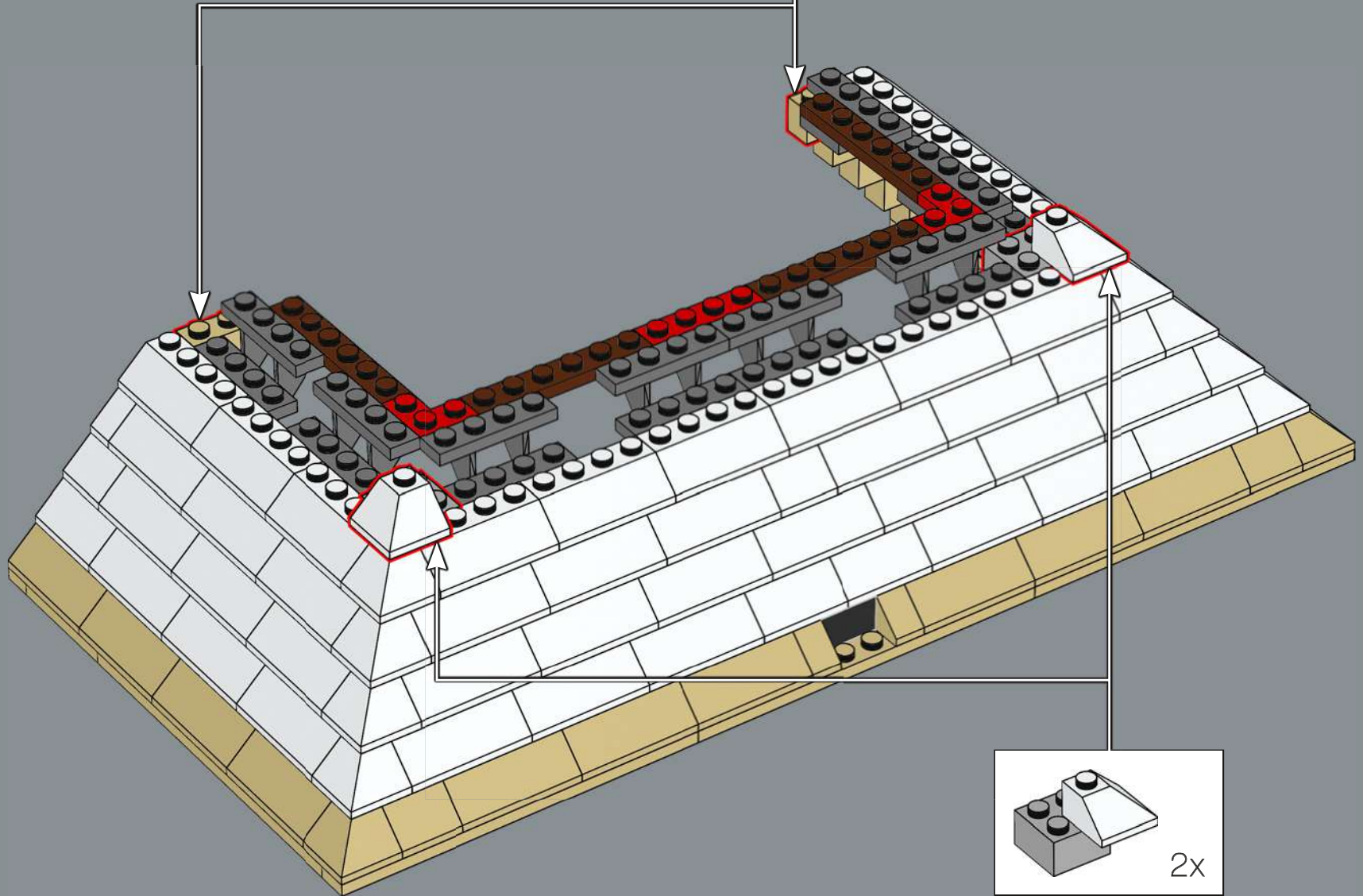
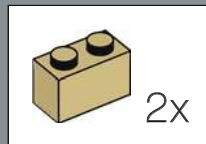

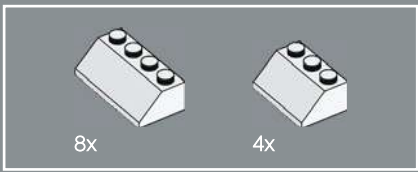

154

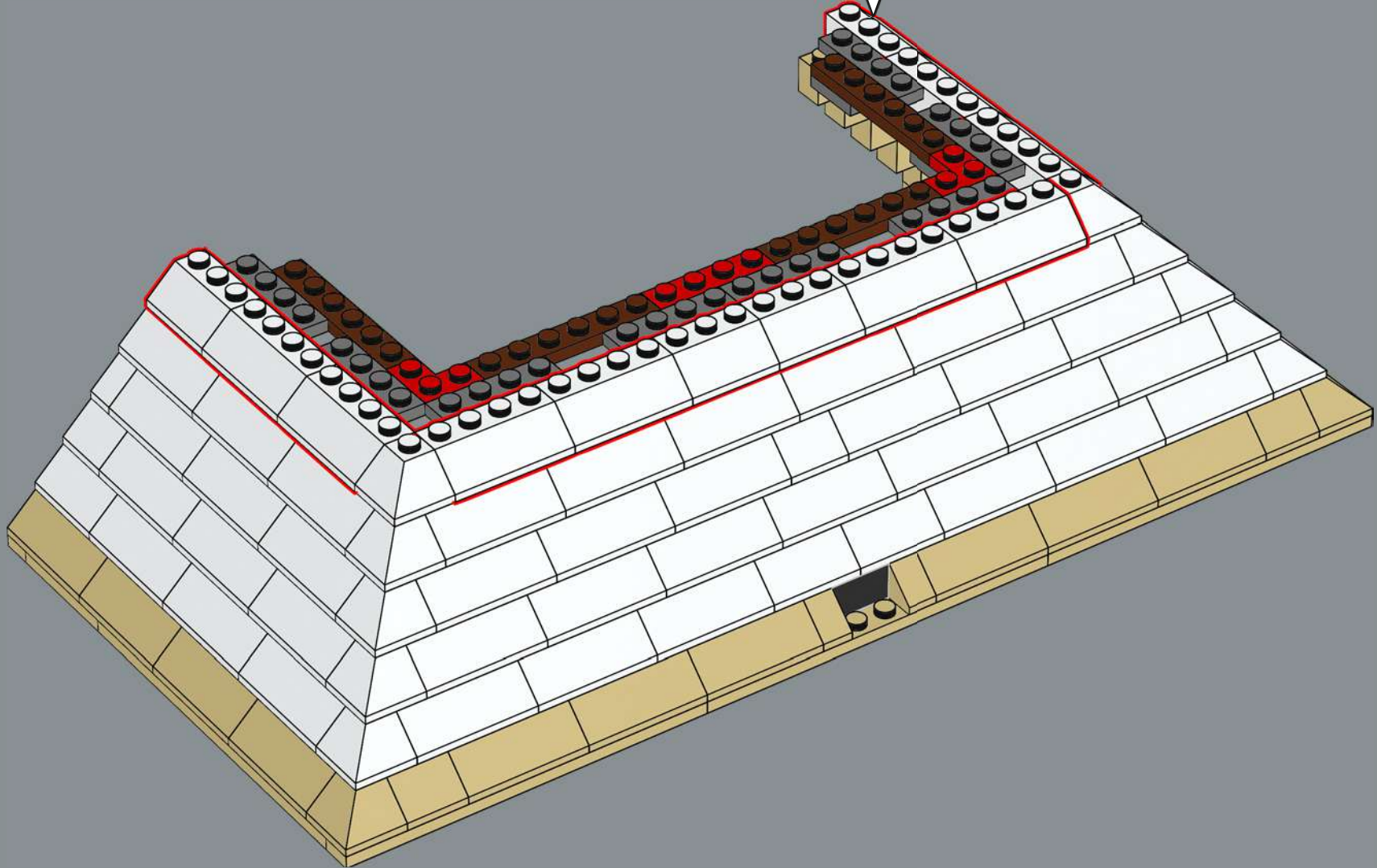
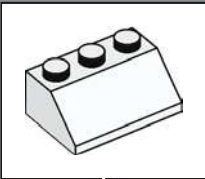

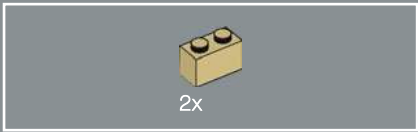

155

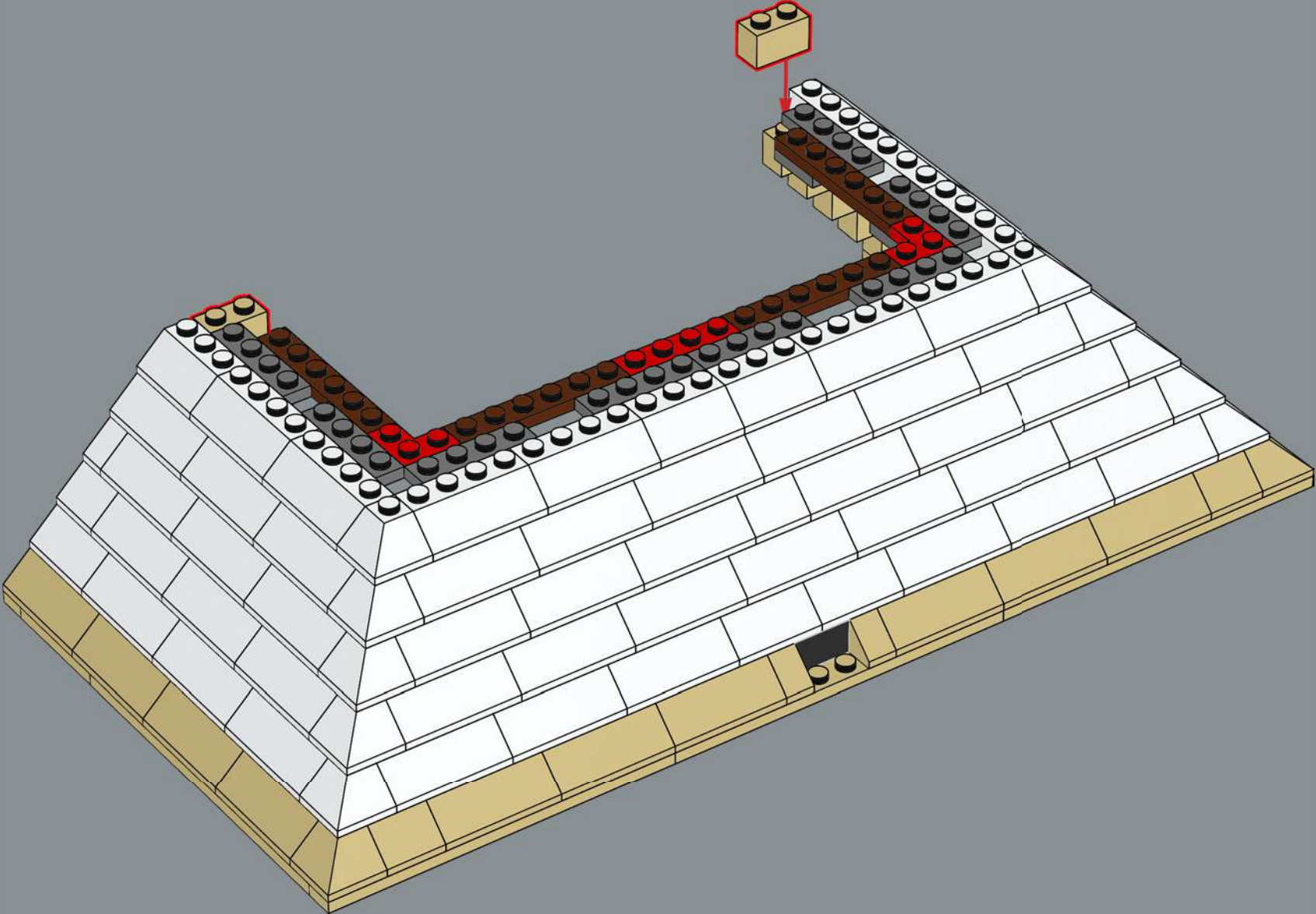



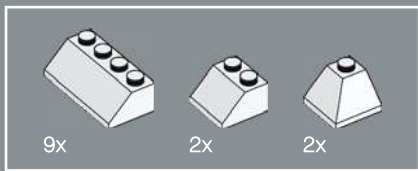

156

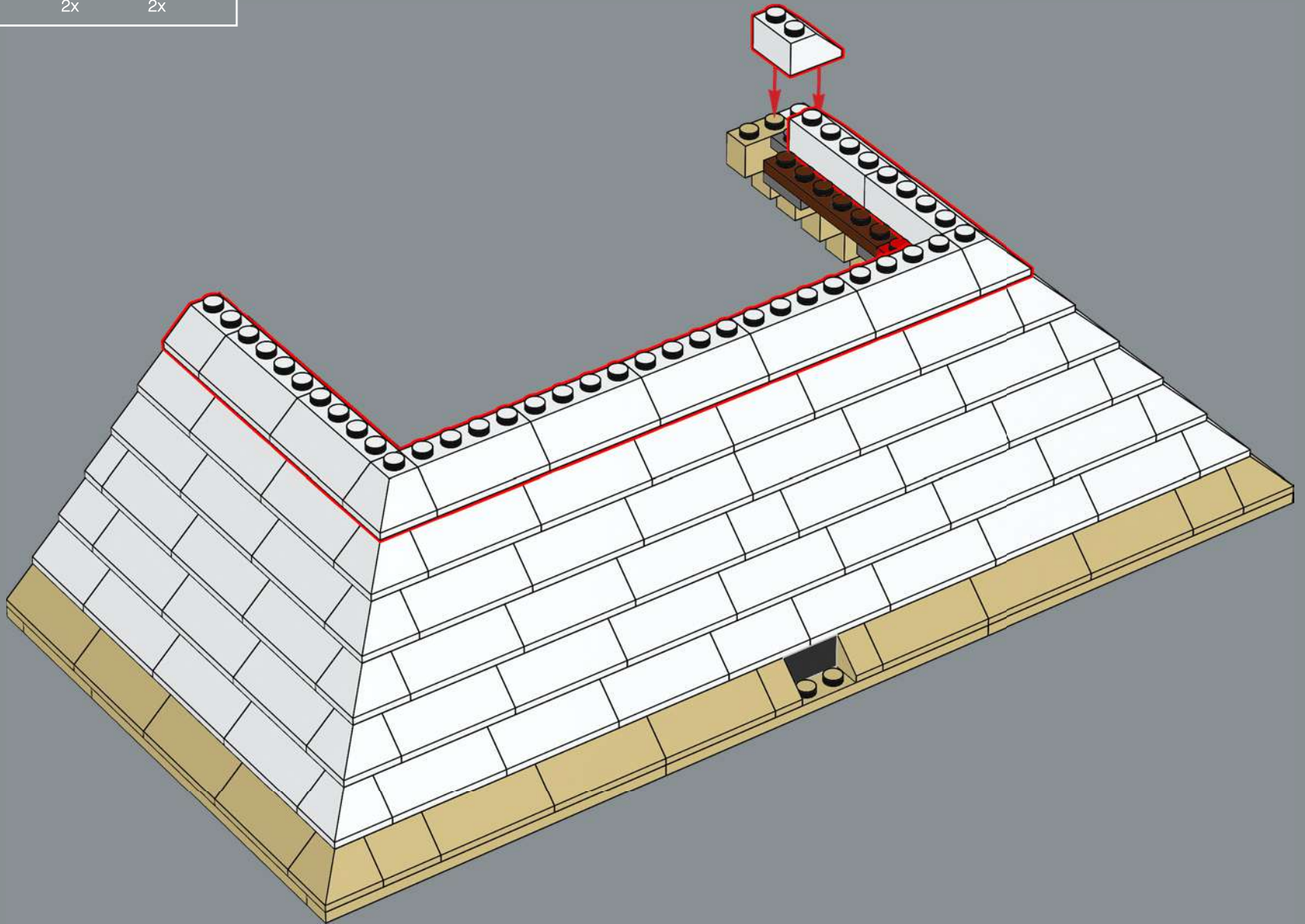

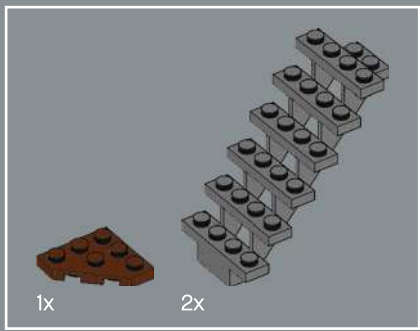

157

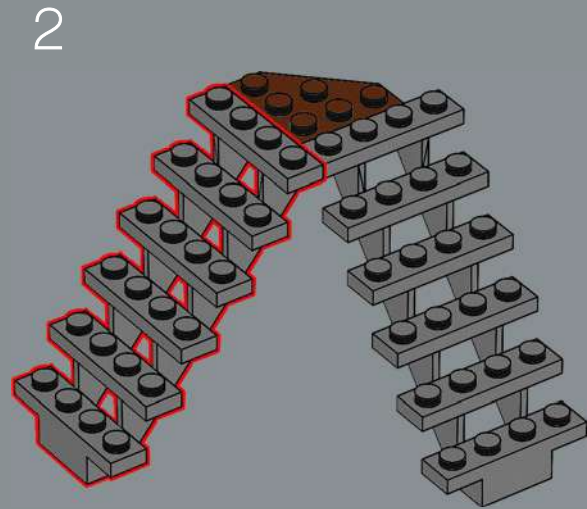
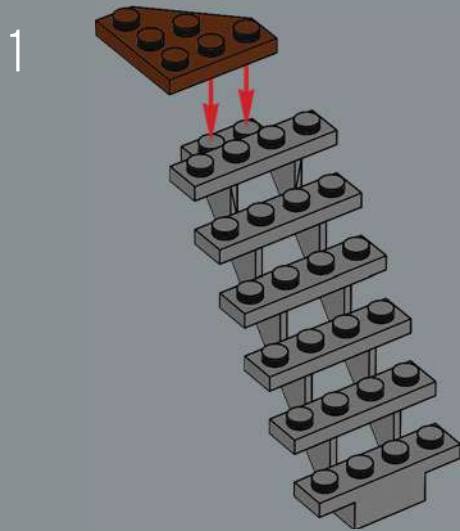

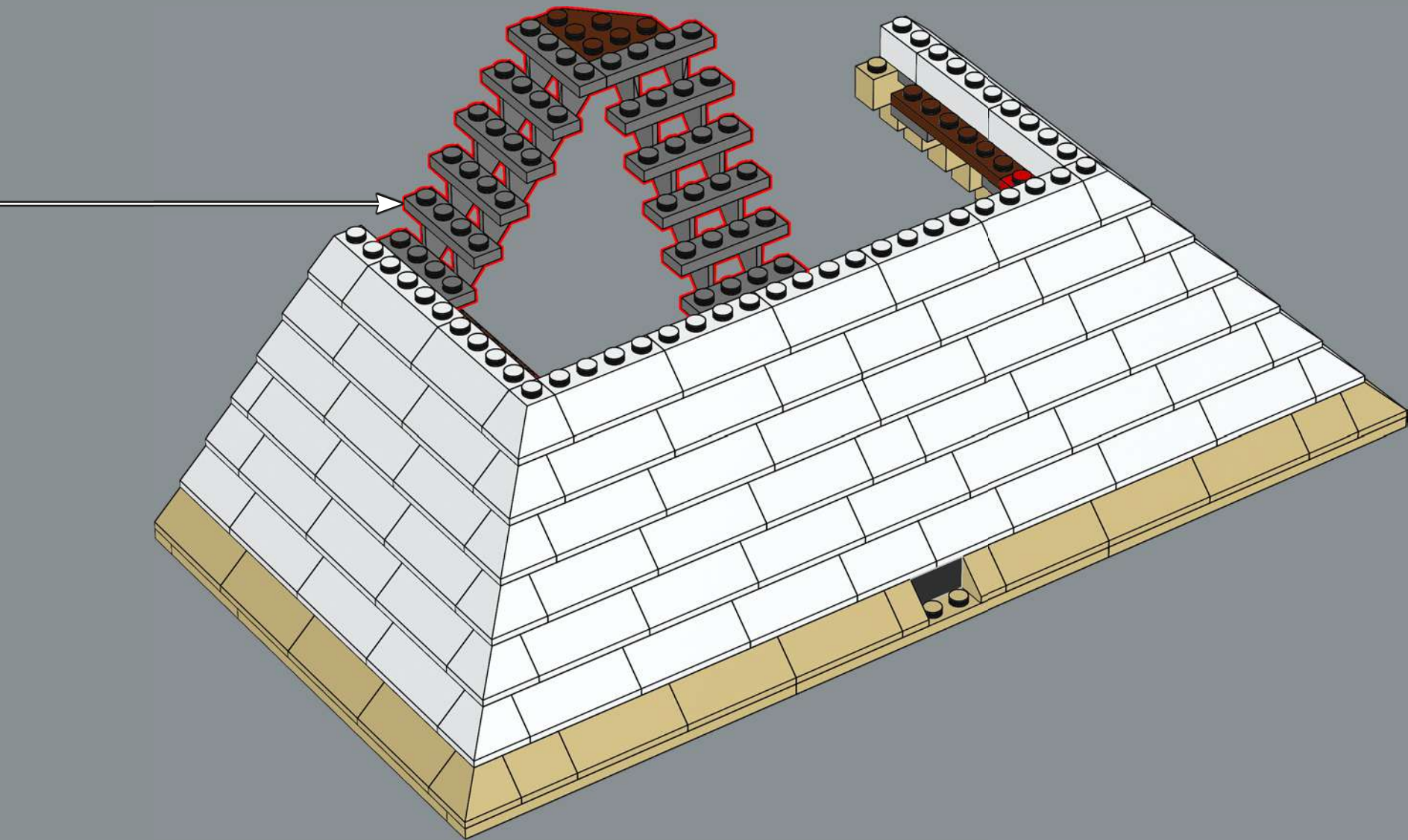

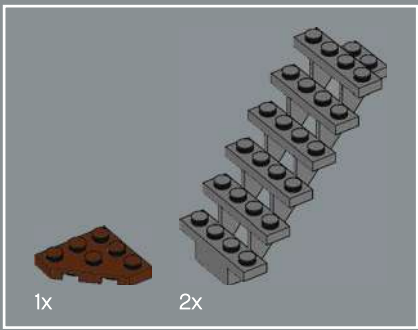

158

1

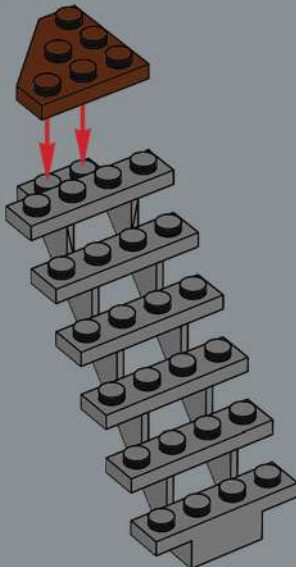

2

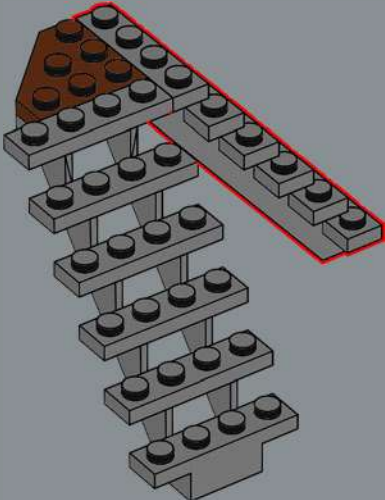

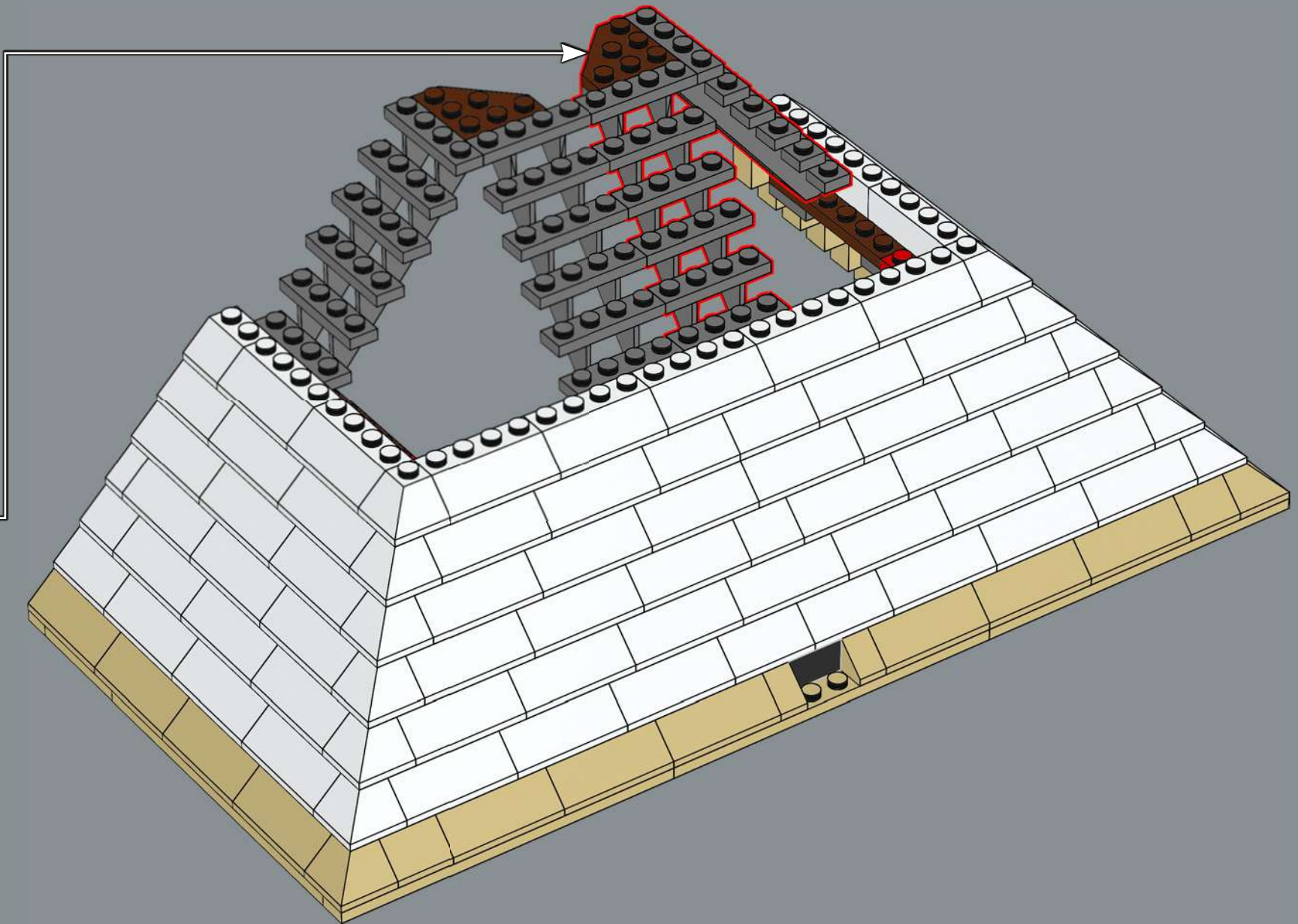

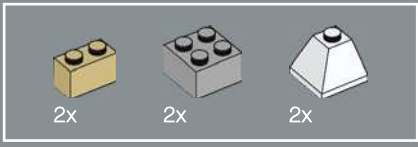

159

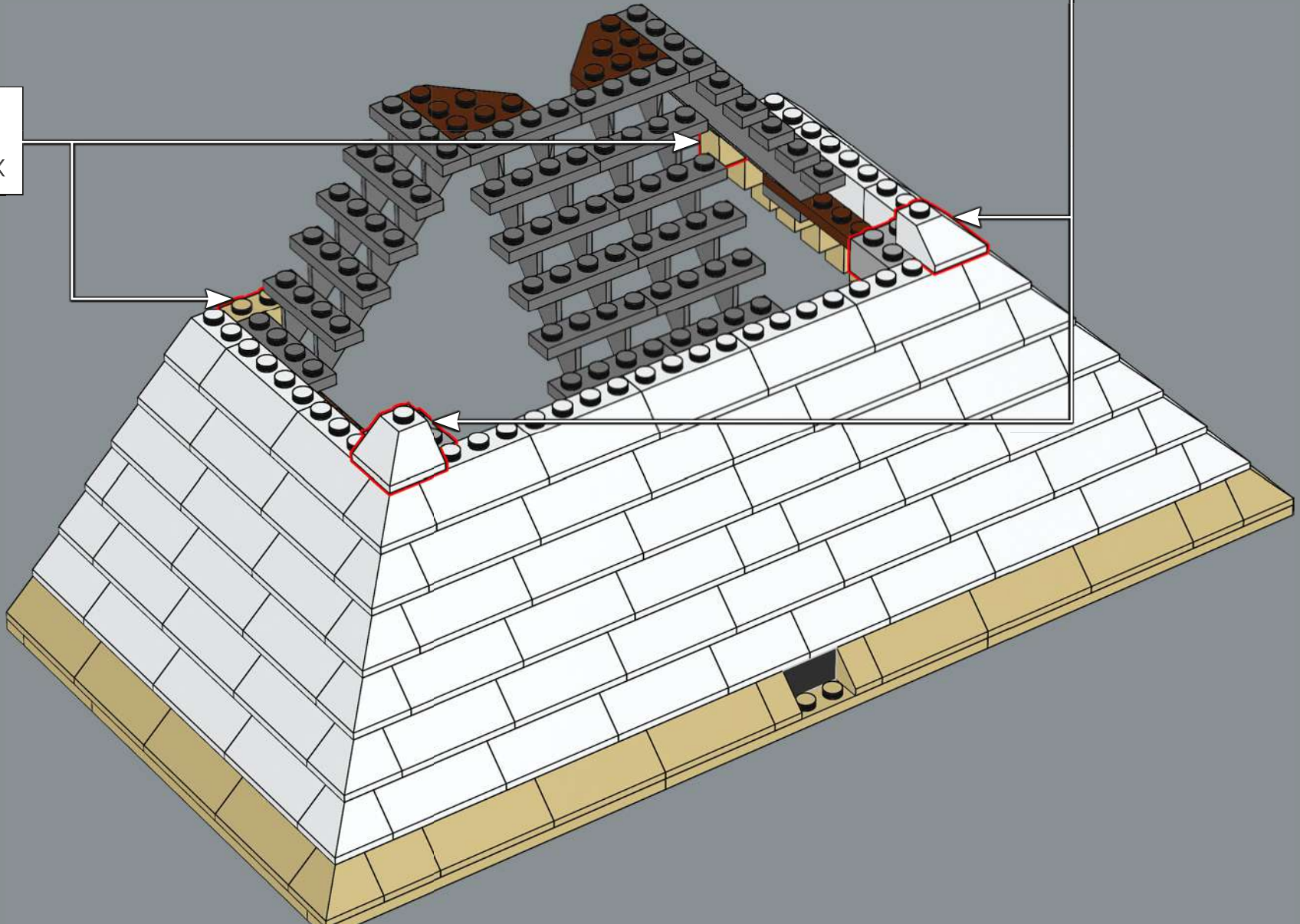
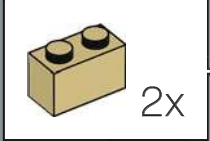
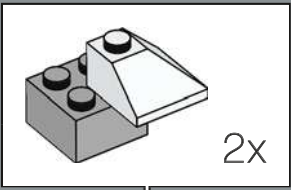

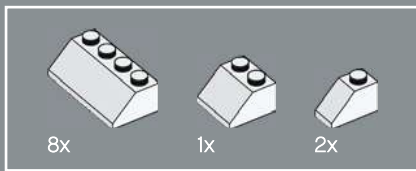

160

You can use the cross axle and matching holes on the back of the model to connect two of these sets together to create a whole Pyramid.

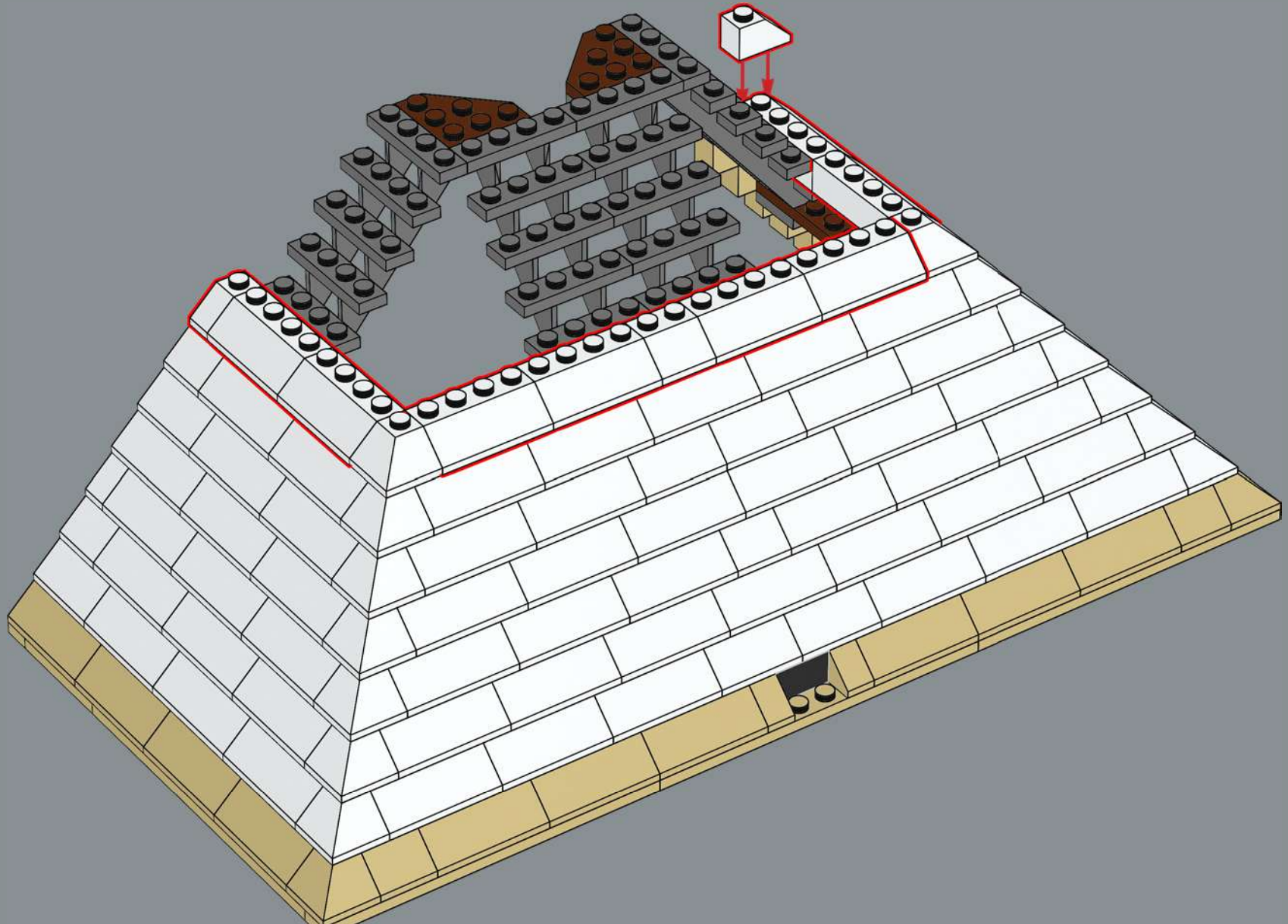
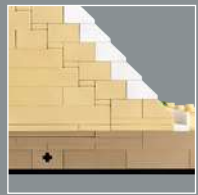

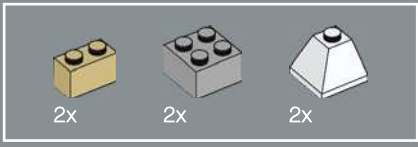

161

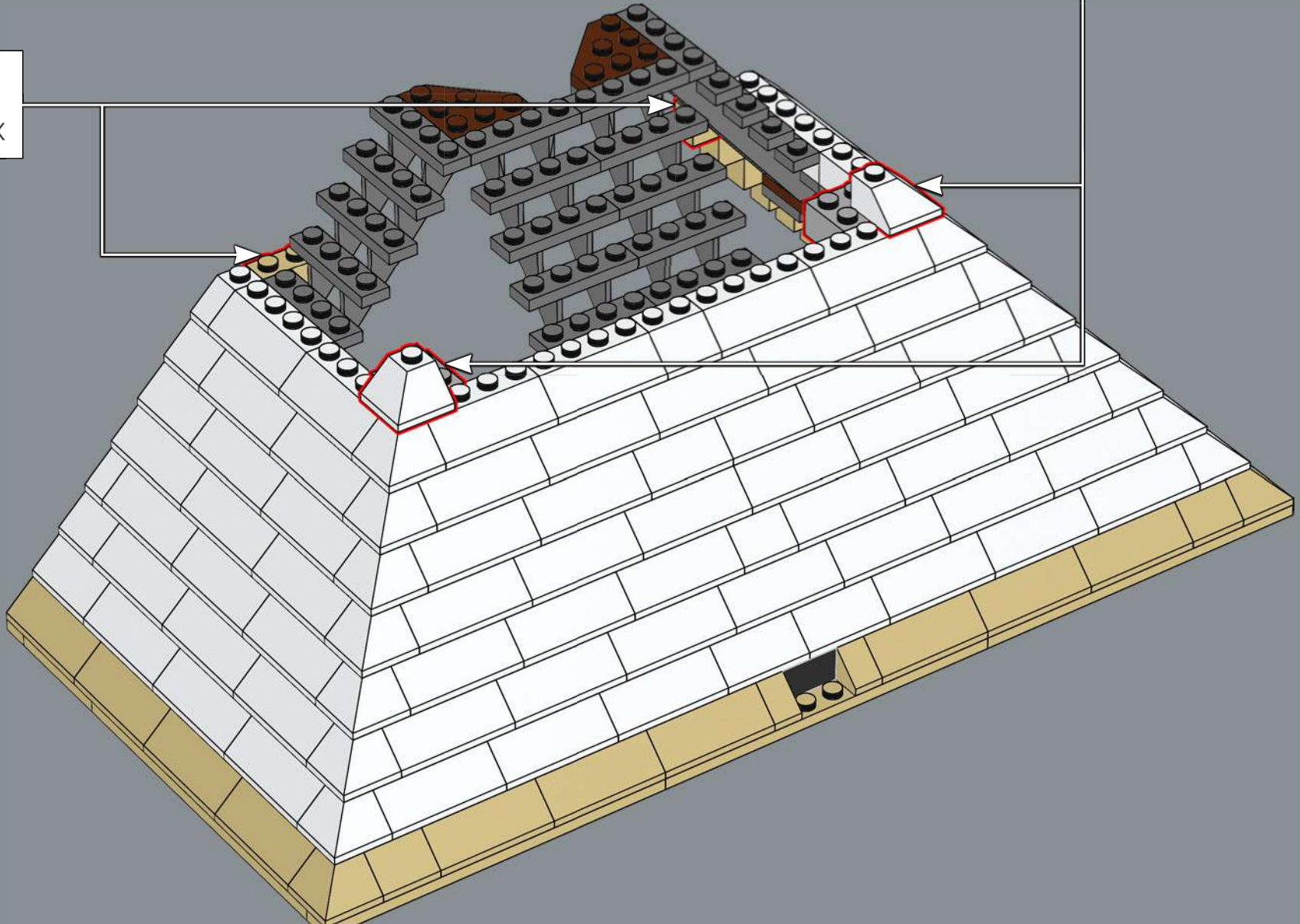
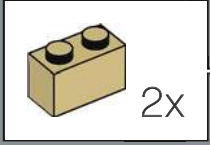
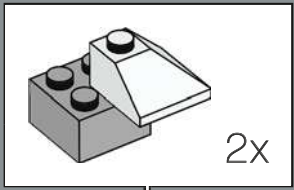

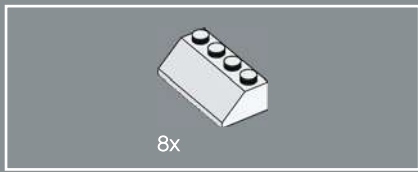

162

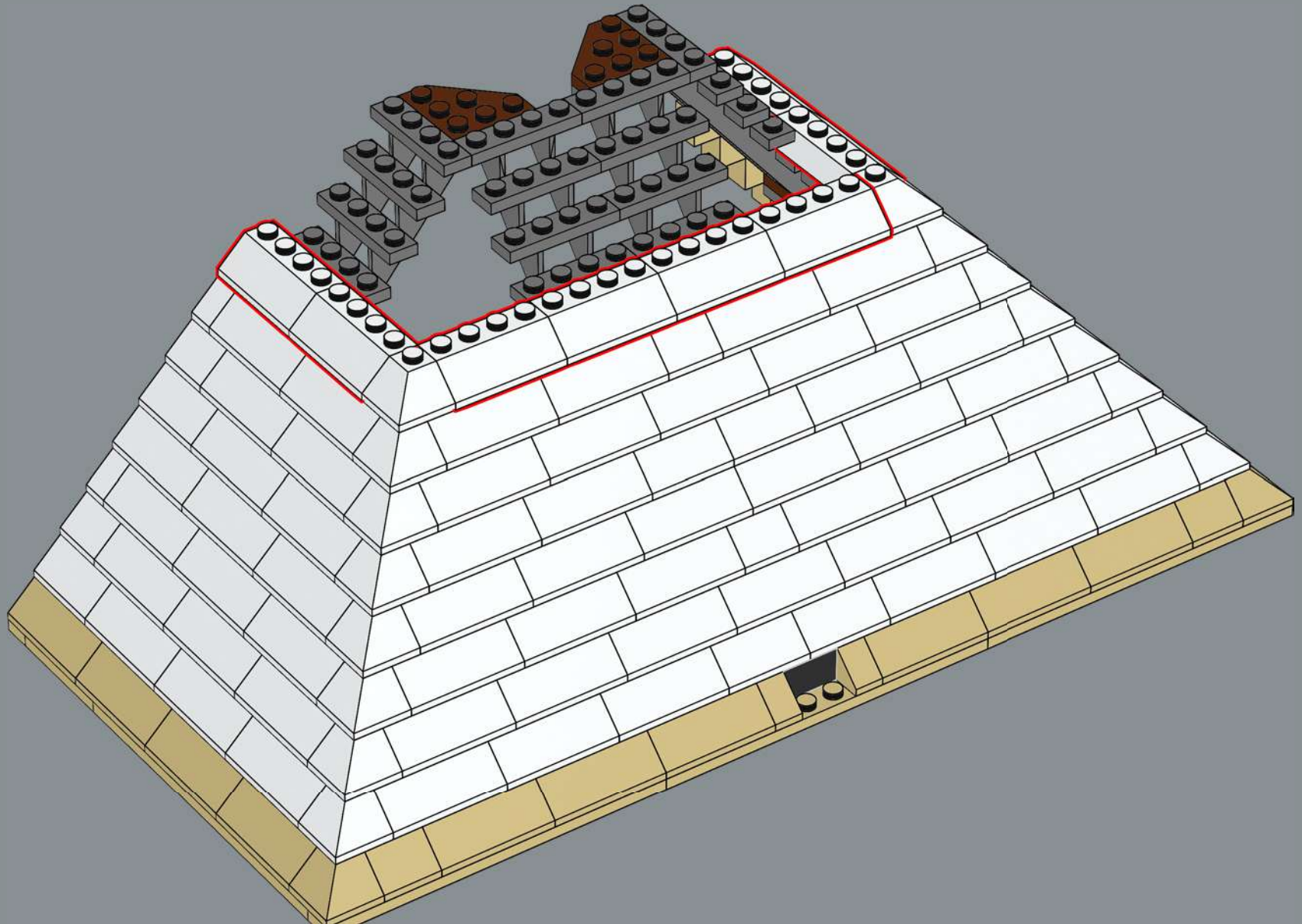

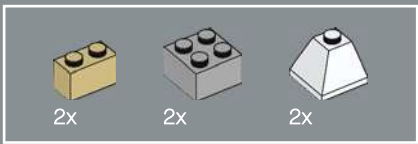

163

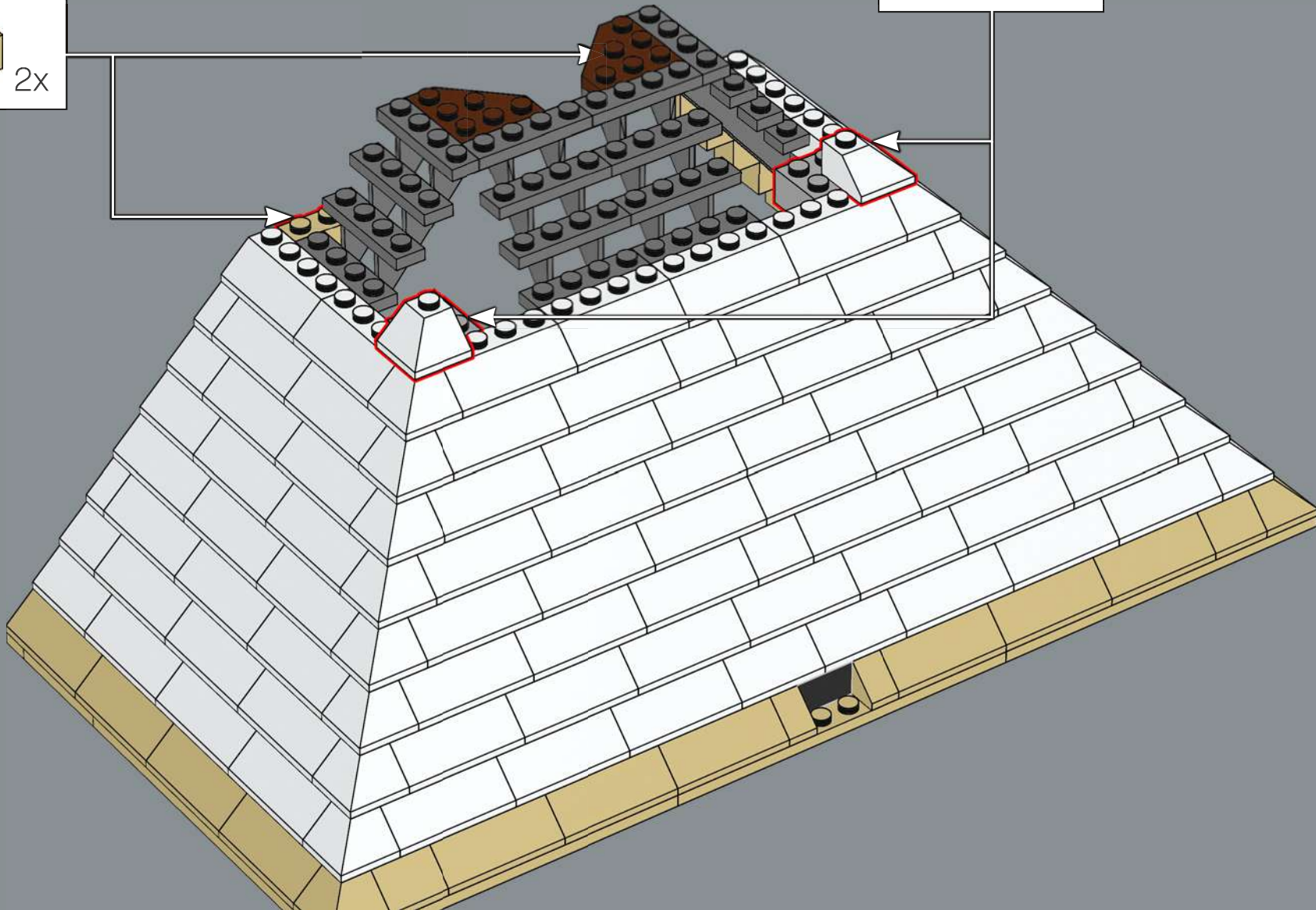
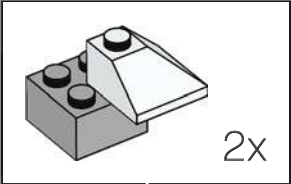
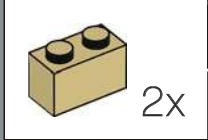

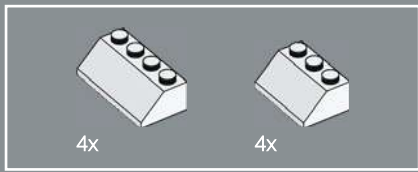

164

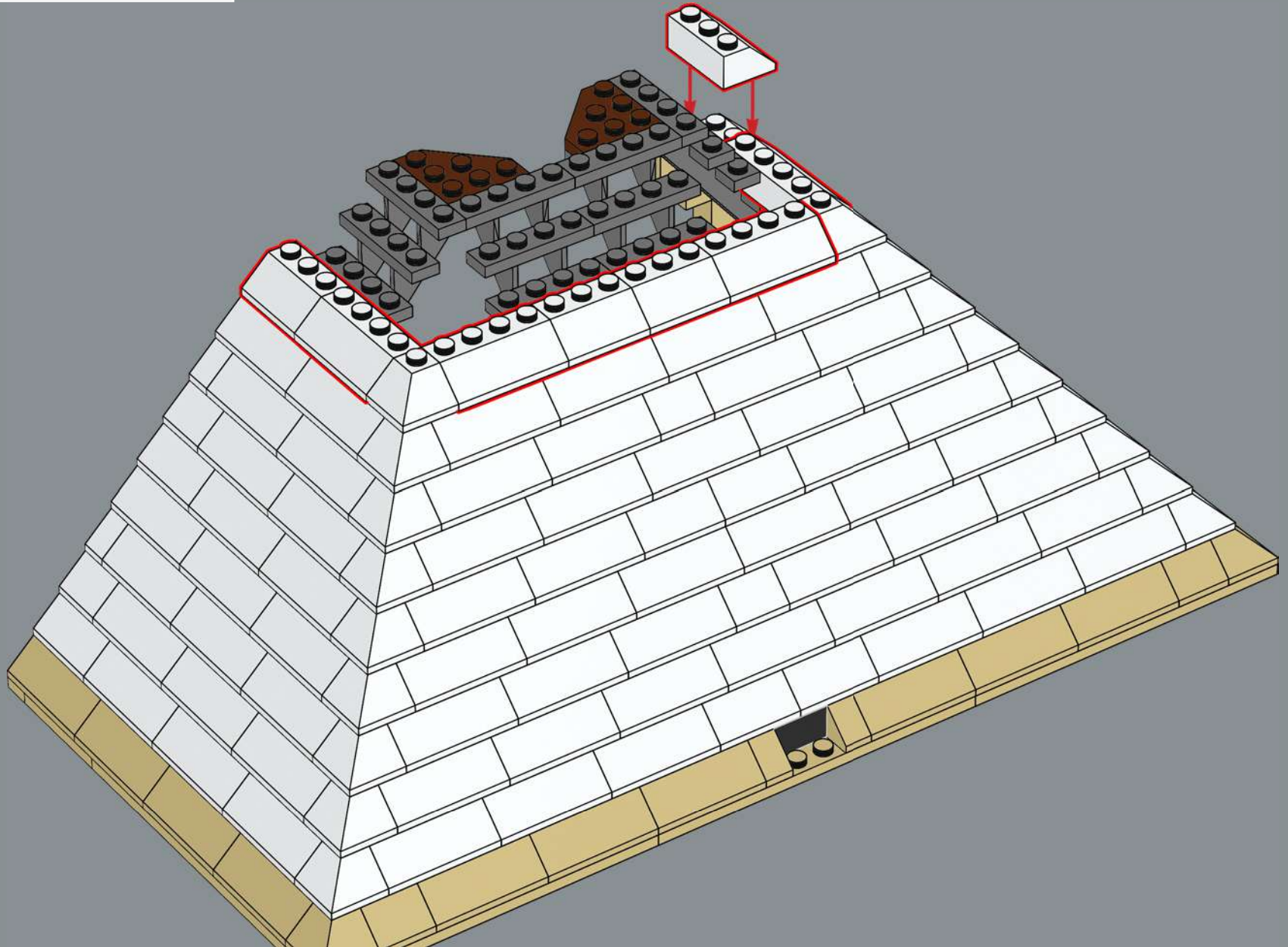

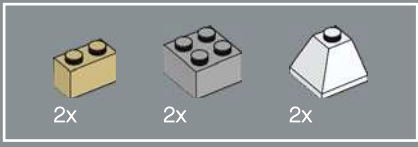

165

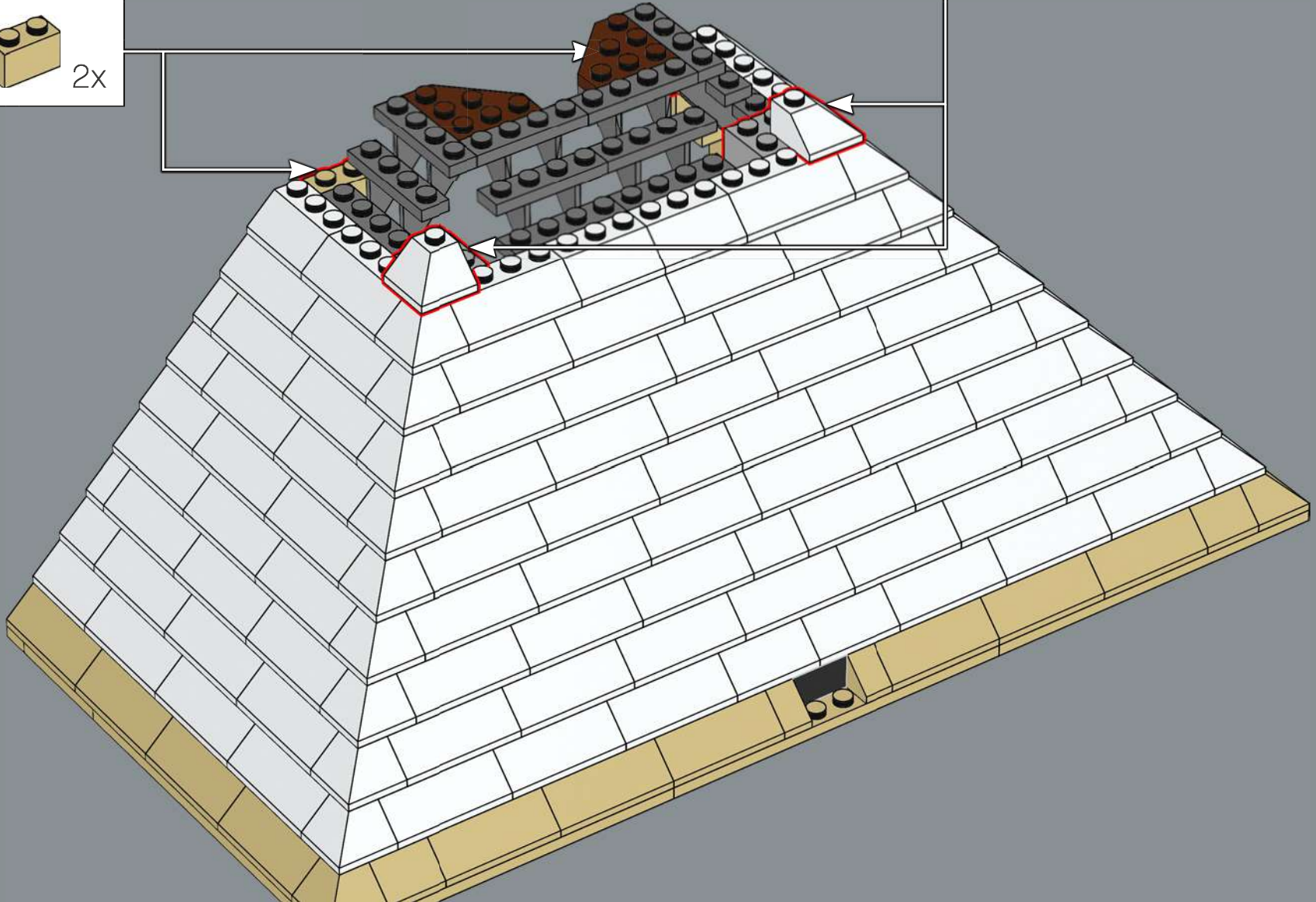
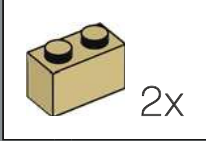
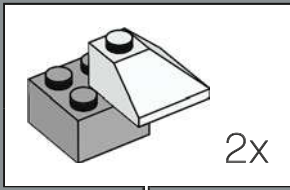

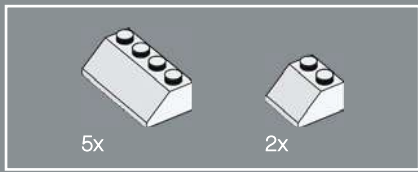

166

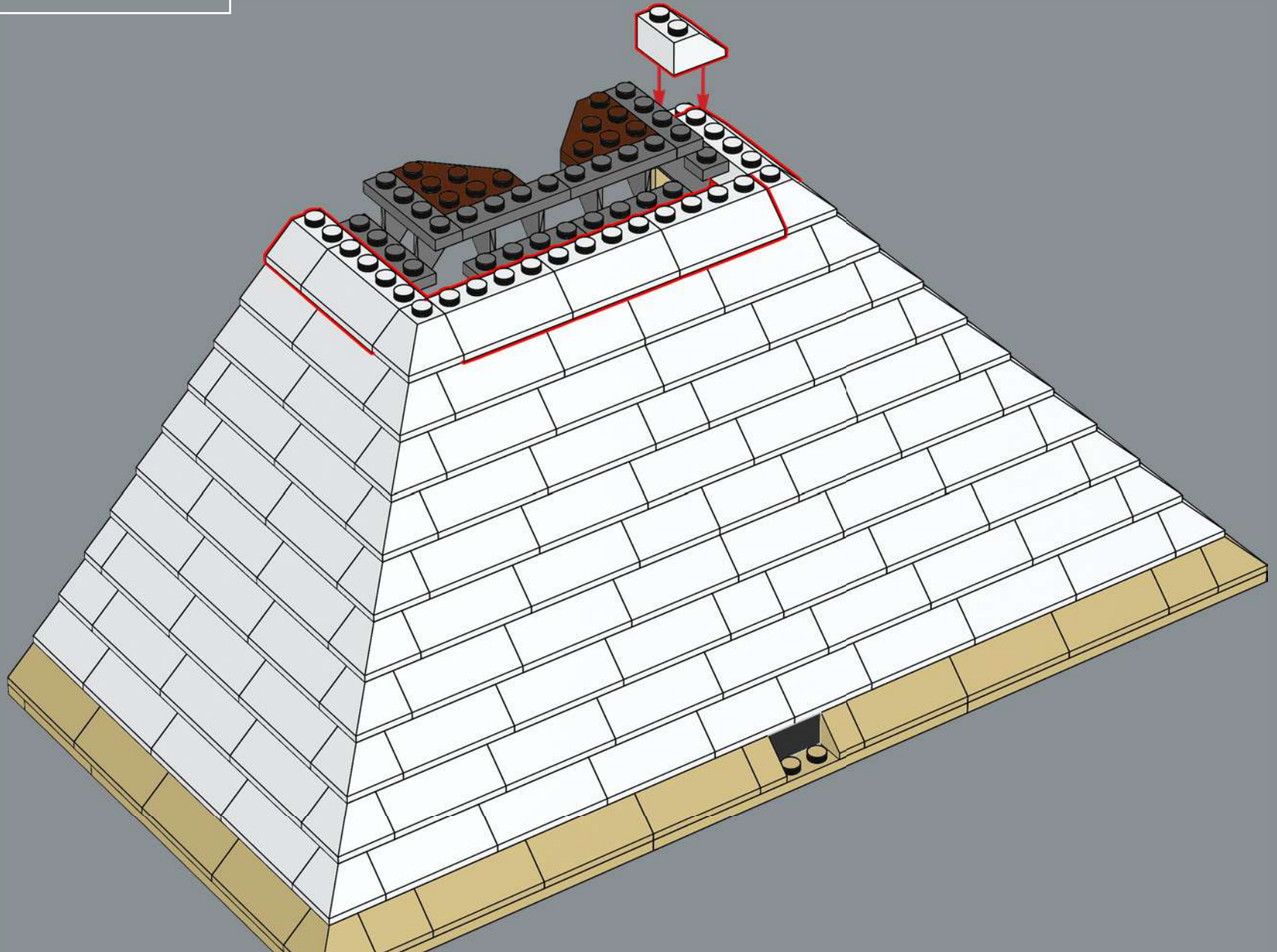



4x

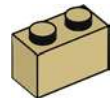

4x

167

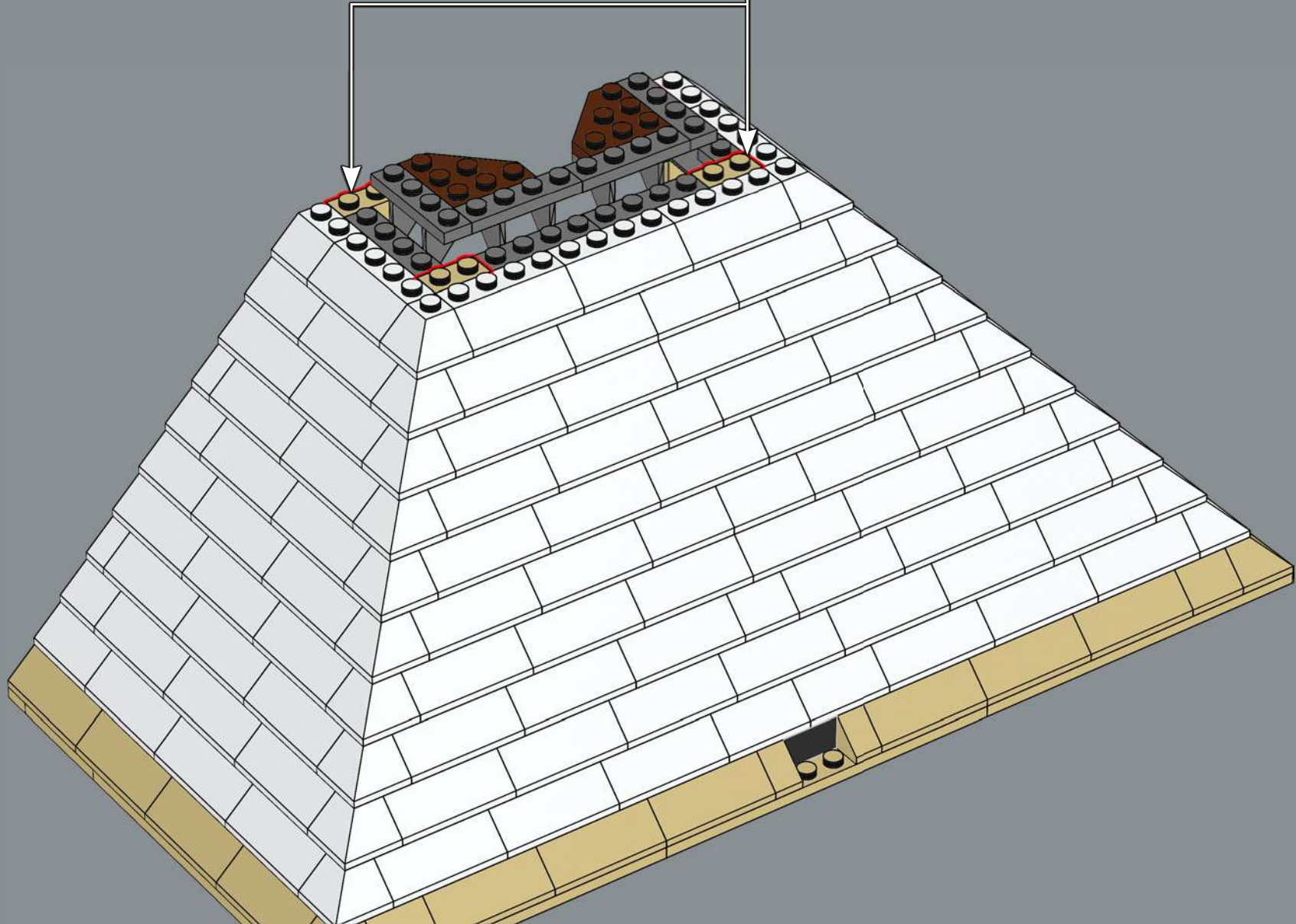

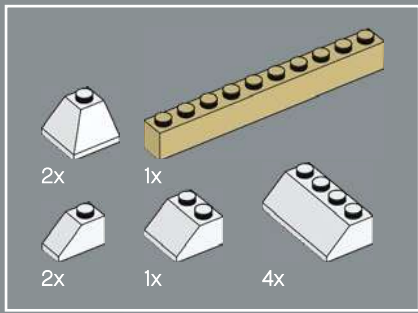

168

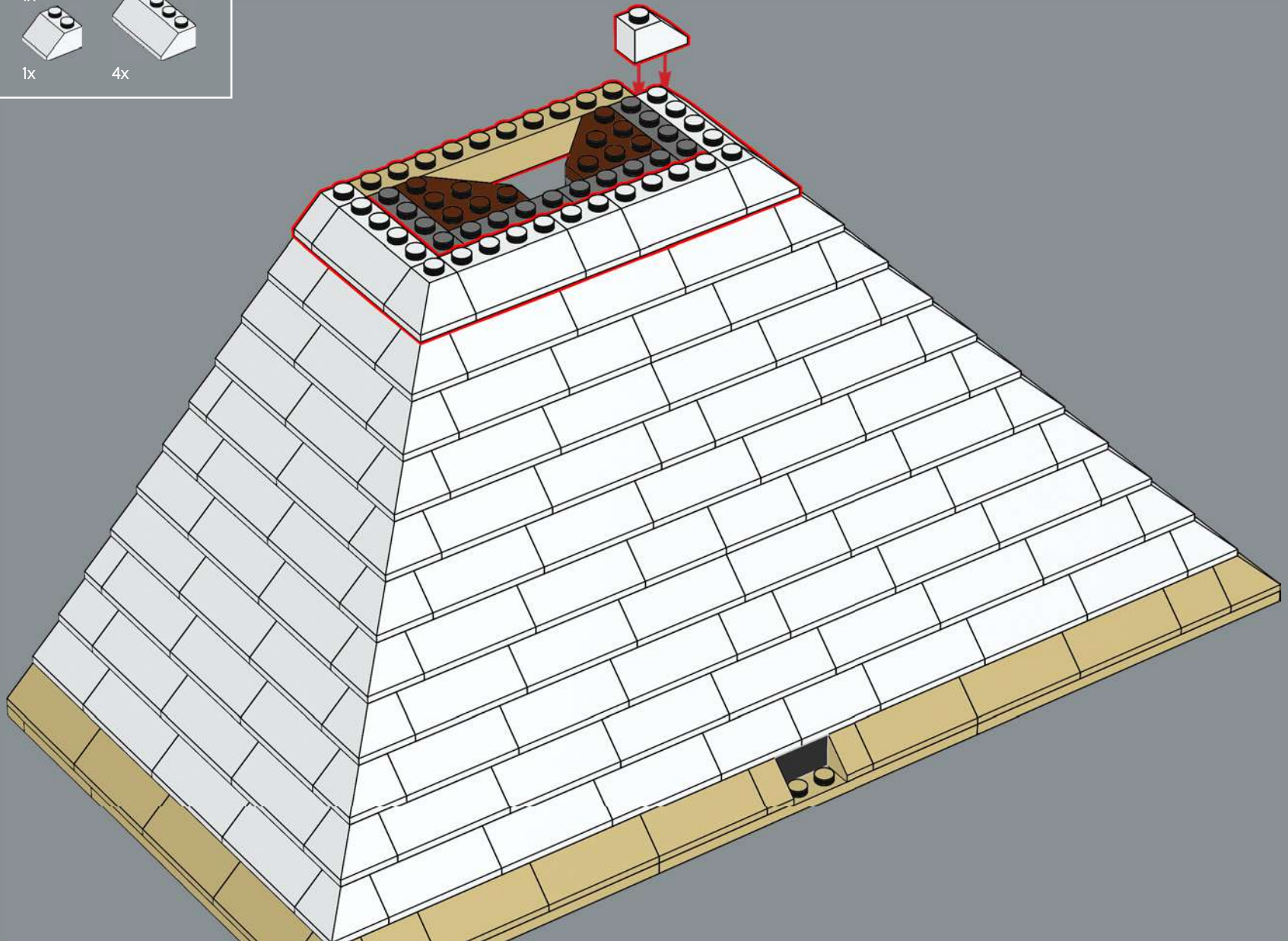

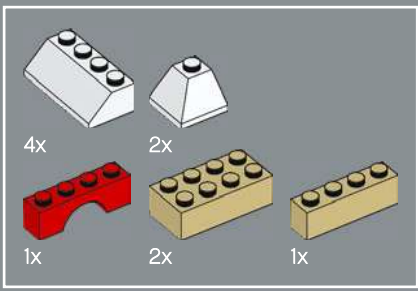

169

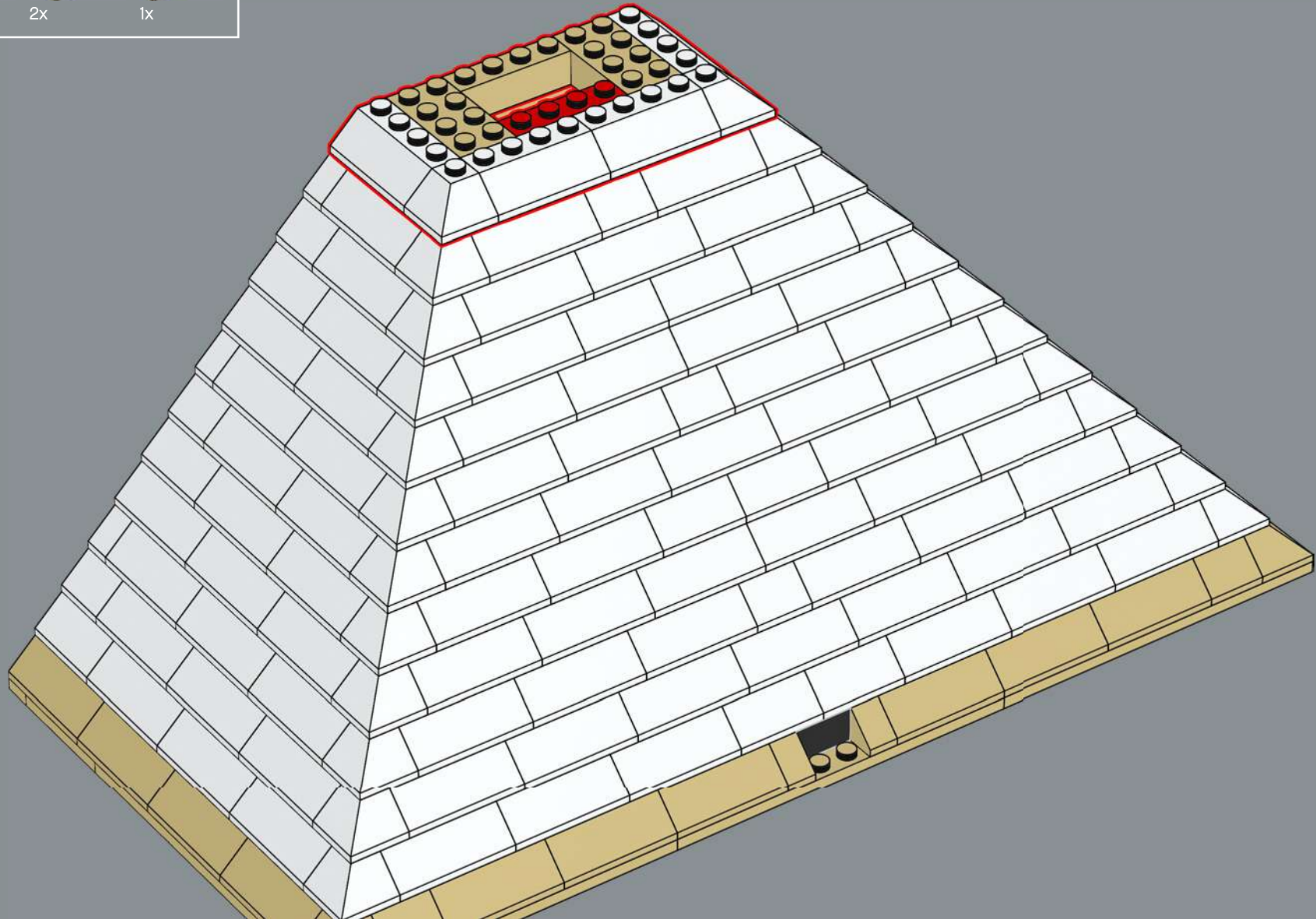

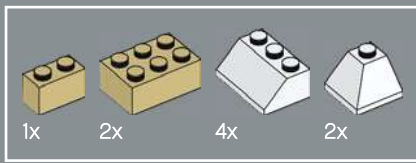

170

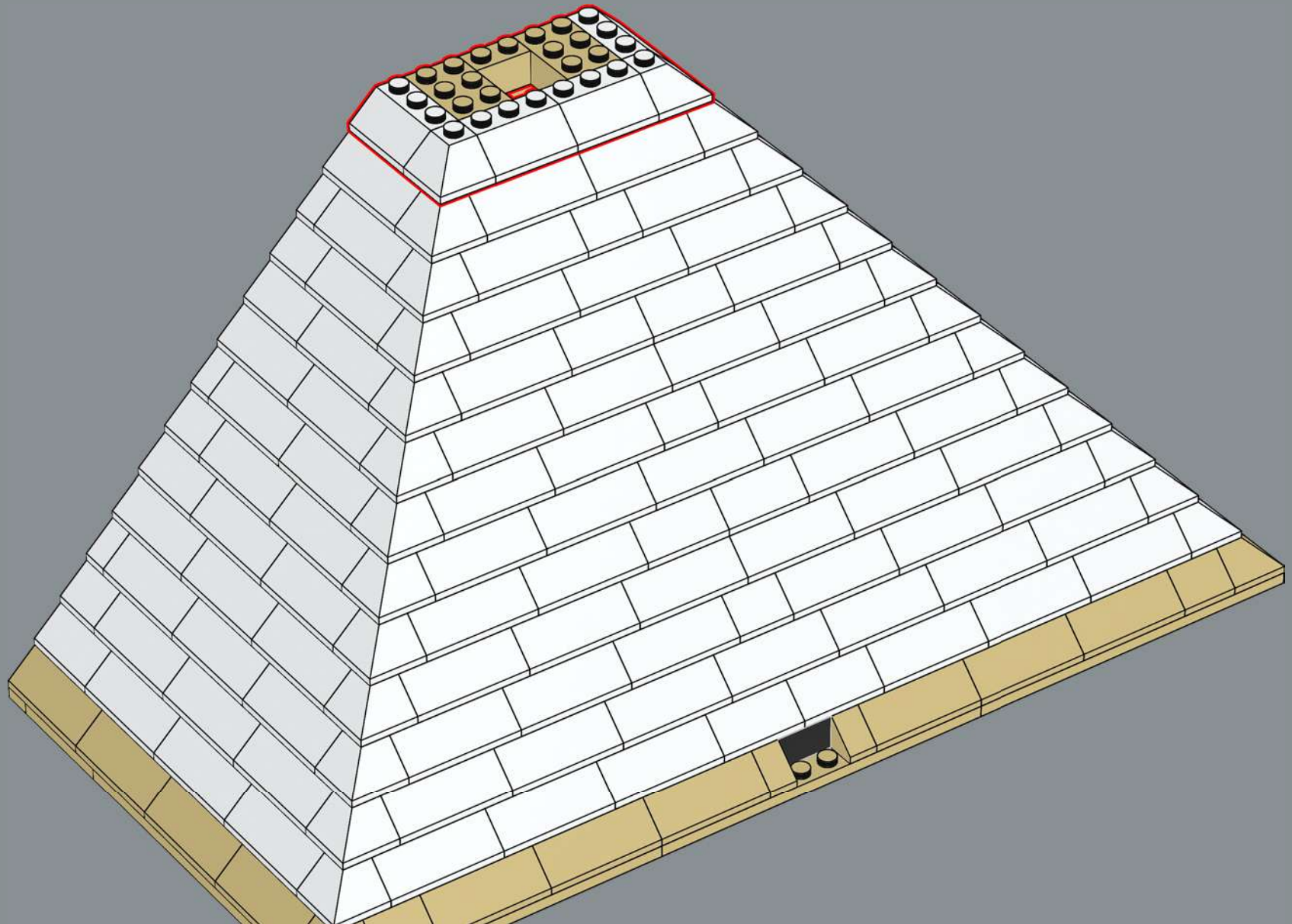

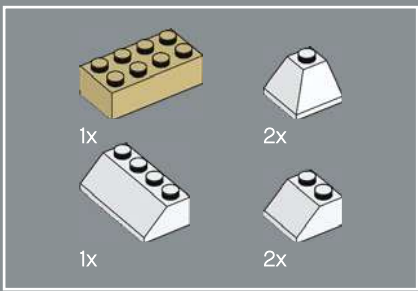

171

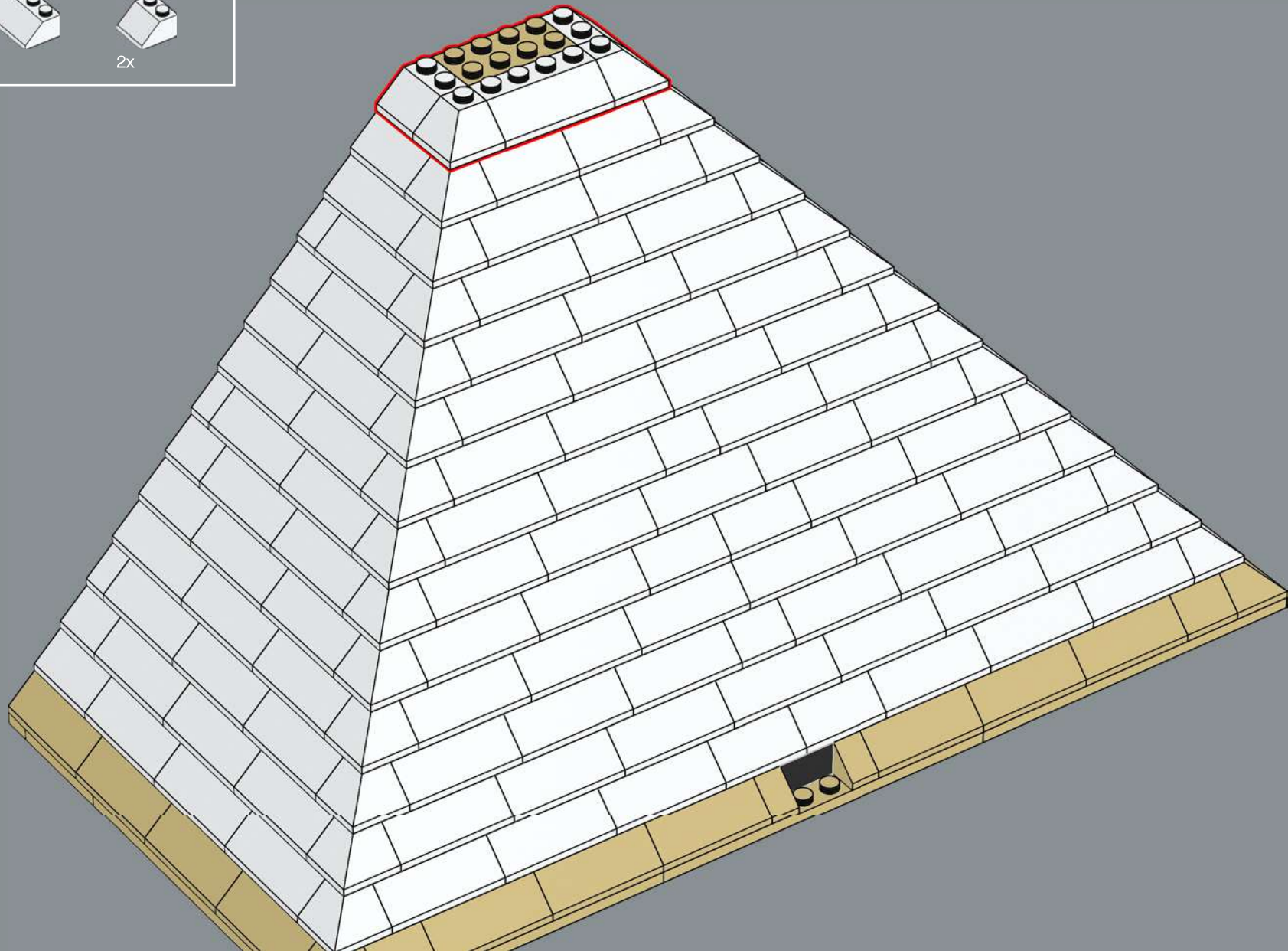

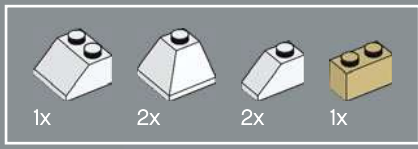

172

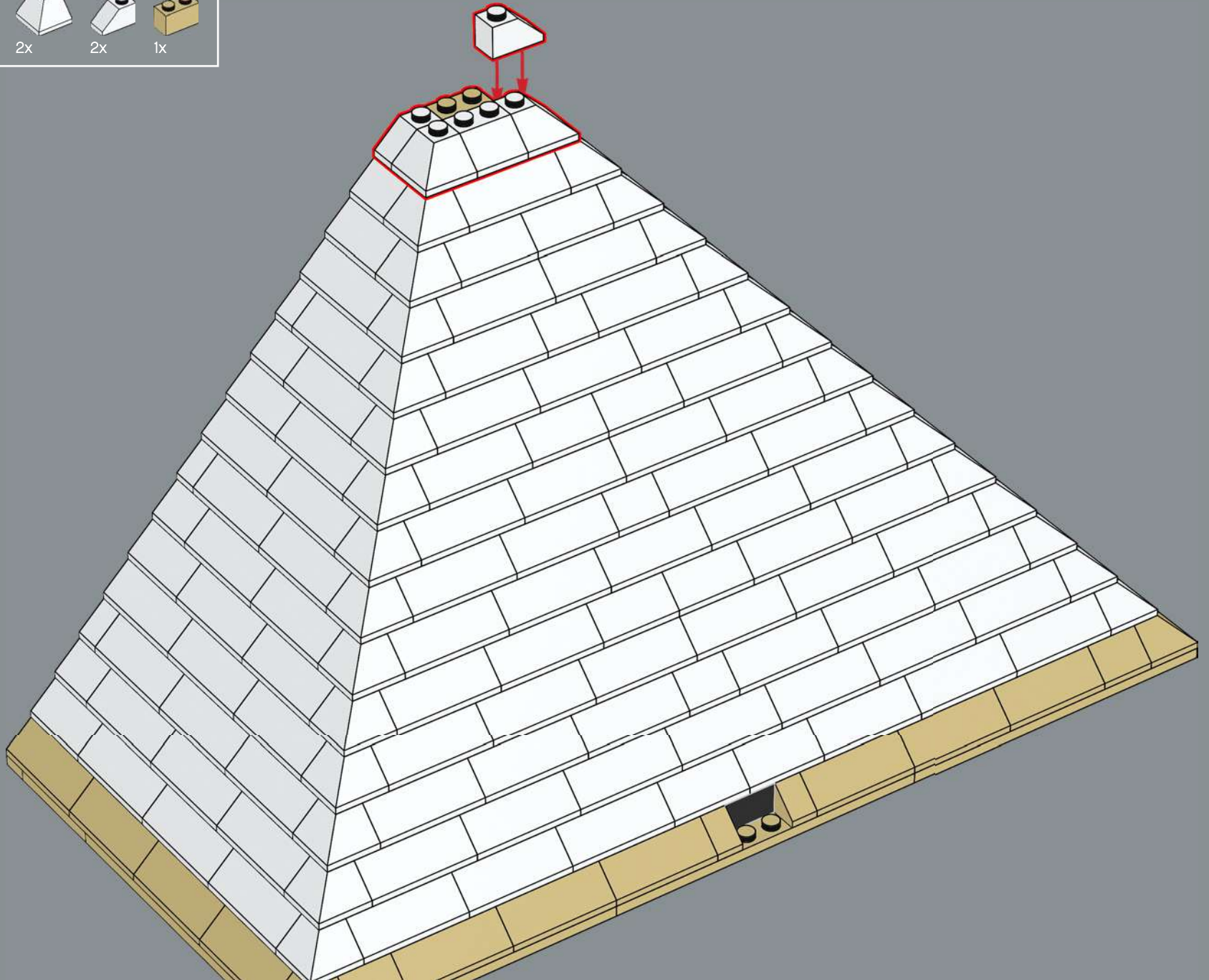

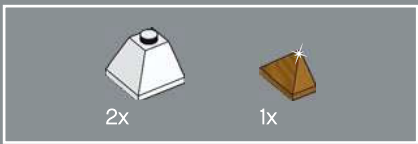

173

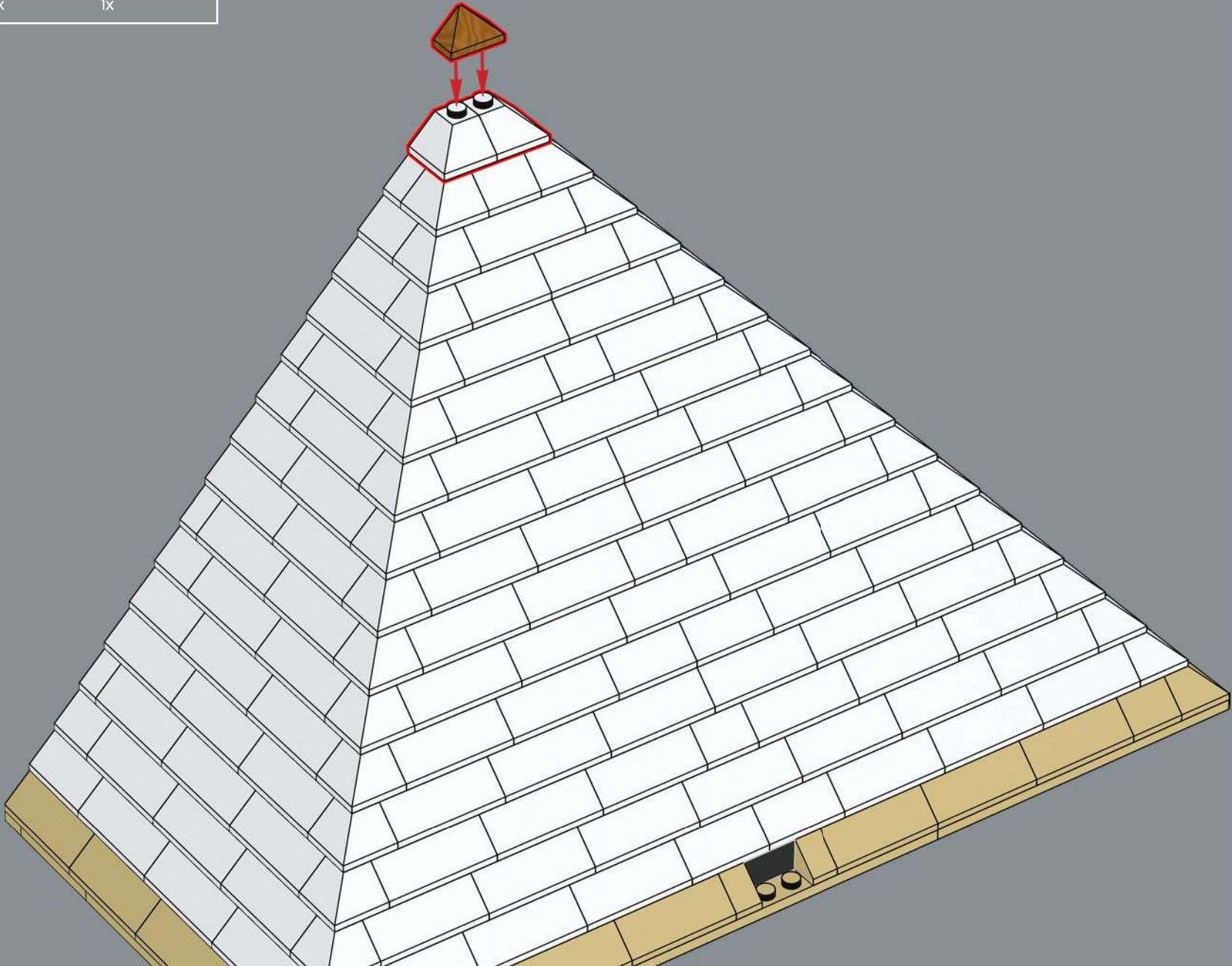

174

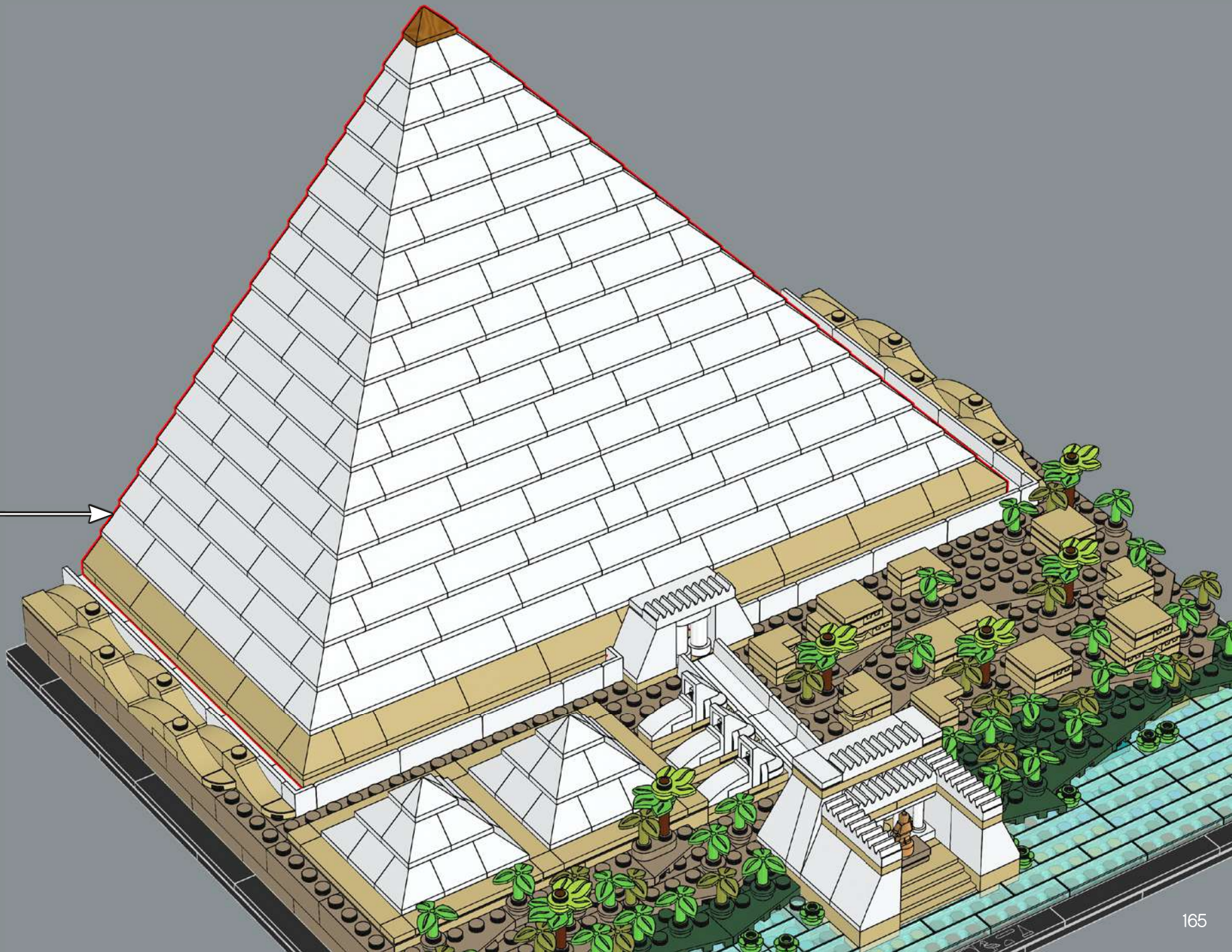

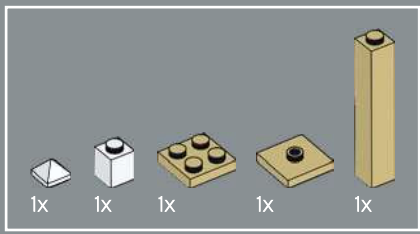

175

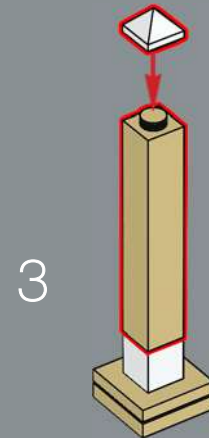
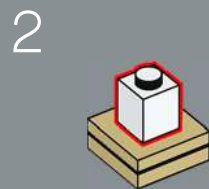
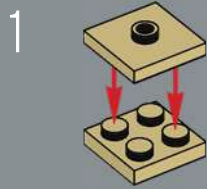





The element forming the golden canopy on the rear of the boat is more commonly seen as a roller skate for LEGO® minifigures.



176

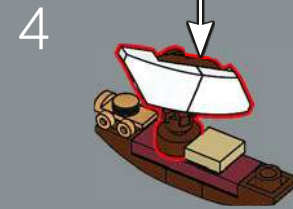
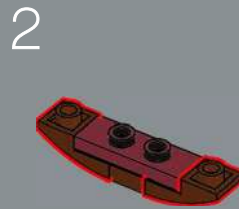
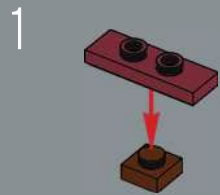
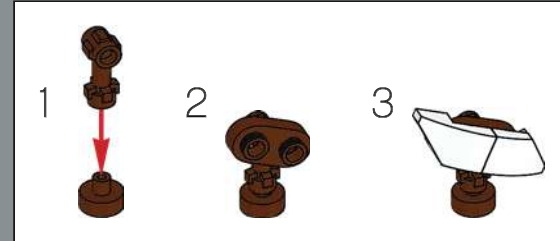



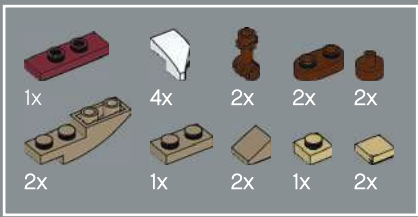

177

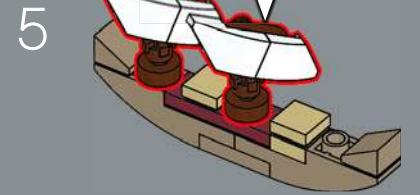
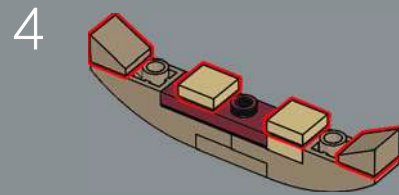
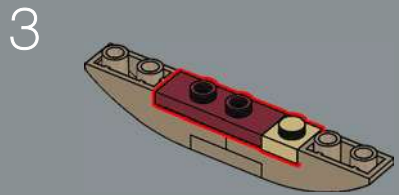
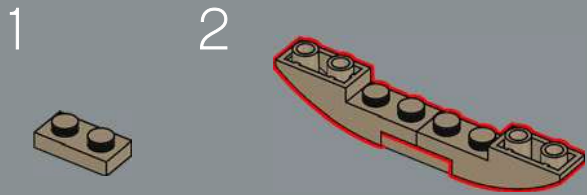
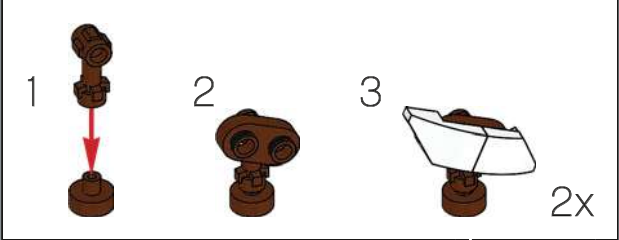





FEEDBACK AND WIN



FEEDBACK AND WIN

Your feedback will help shape the future development of this product series.

Please visit:

FEEDBACK UND GEWINNEN

Dein Feedback trägt zur Weiterentwicklung dieser Produktreihe bei.

Geh auf:

COMMENTEZ ET GAGNEZ

Vos commentaires nous aideront à concevoir les futurs produits de cette gamme.

Rendez-vous sur :

COMENTA Y GANA

Tu opinión nos ayudará a dar forma al desarrollo de esta serie de productos en el futuro.

Visita:

反馈有奖

您的反馈将有助于我们在今后改进本系列产品。

请访问：

[LEGO.com/productfeedback](https://www.lego.com/productfeedback)

By completing, you will automatically enter a drawing to win a LEGO® set.

Terms & Conditions apply.

Durch Ausfüllen nimmst du automatisch an der Verlosung eines LEGO® Preises teil.

Es gelten die Teilnahmebedingungen.

En envoyant vos commentaires, vous serez automatiquement inscrit(e) à un tirage au sort qui vous permettra de remporter un prix LEGO®.

Offre soumise à conditions.

Al contestar, participarás automáticamente en el sorteo y podrás ganar un set LEGO®.

Sujeto a Términos y Condiciones.

完成我们的反馈调查，即可自动进入抽奖环节，赢取乐高®套装。

适用《条款和条件》。

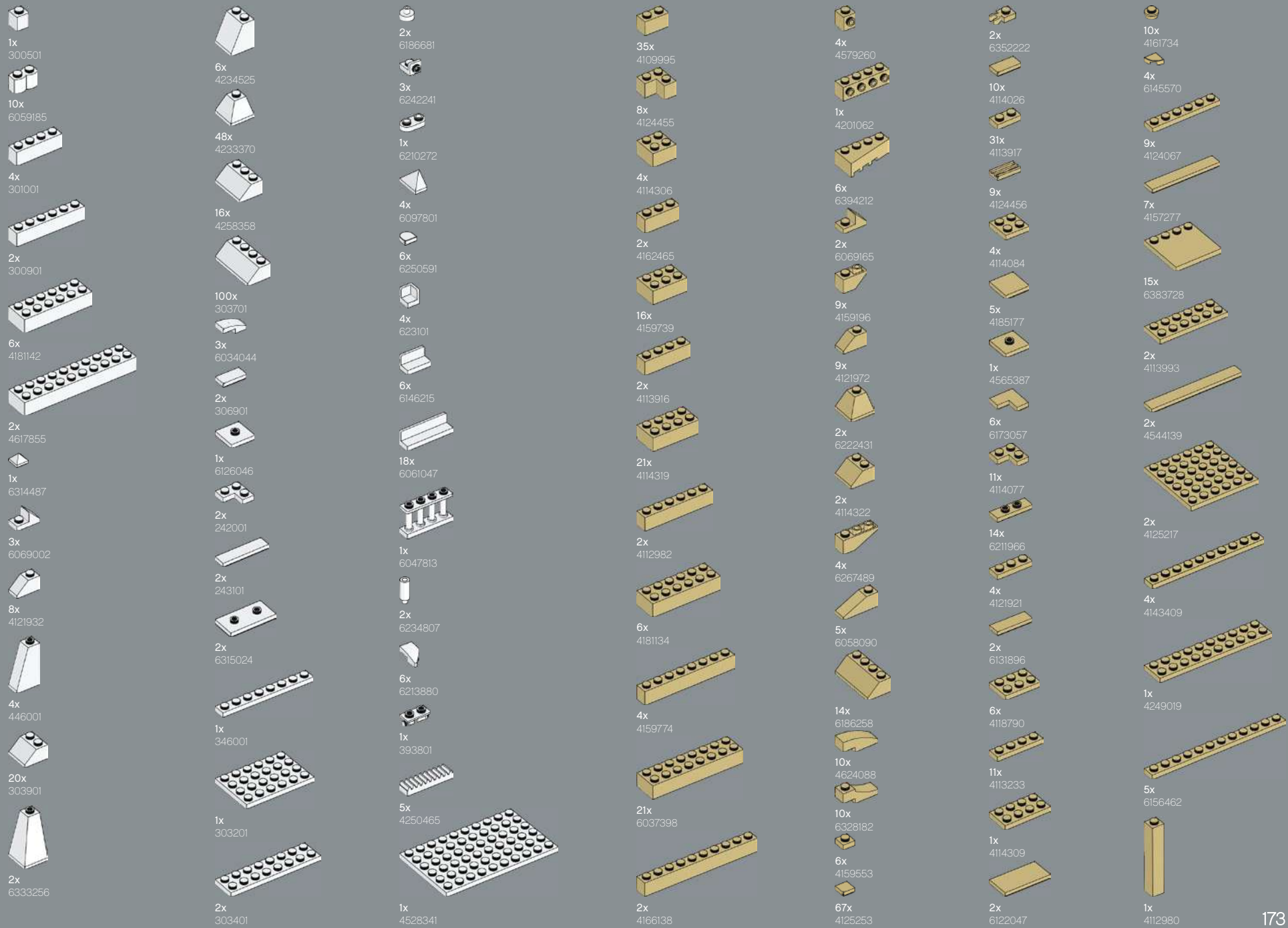



2x
6177890



4x
4208072



2x
6099893



4x
6213676

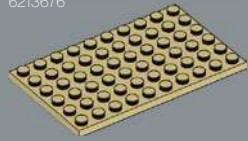

4x
4624185

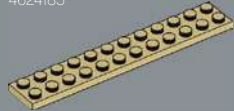

6x
6093864

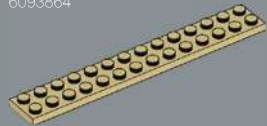

1x
6036487

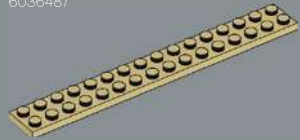

2x
6030980



16x
6186030



16x
6285465



1x
403223



1x
6102759



1x
362221

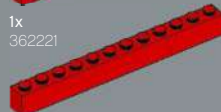

2x
611221



3x
4651524



1x
365921



1x
302321



4x
306921



2x
306821



2x
242021



5x
371021



3x
302021



2x
366621



1x
4142865



11x
306224



4x
302324



2x
302224



7x
300426



6x
362226



7x
301026



2x
302426



2x
6133722



4x
4558170



1x
302126



2x
371026



2x
366626



2x
4243819



1x
6323899



12x
416226



1x
6323898



1x
6323898



2x
346026



16x
303626

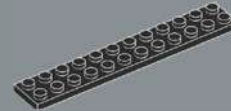

1x
244526

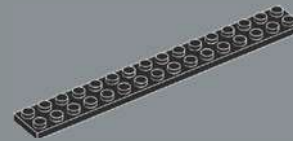

6x
428226



1x
4107761



1x
6096956



2x
4541191



2x
6278152



1x
393726



2x
4124096



4x
302328



2x
302028



13x
6206150



29x
6235080



6x
6182261



3x
6092602



2x
6290986



6x
6252043



9x
6251295



6x
6240222



48x
6252049



1x
6240515



6x
6259794



3x
4518611



1x
6212989



1x
6167483



6x
6286831



Customer Service
 Kundenservice
 Service Client
 Assistenza clienti
 Atención al cliente
 Serviço de Apoio ao Consumidor
 Ügyfélszolgálat
 Klientu apkalpošanas dienests
 Serviciul pentru clienți
 客户服务
 콘슈어머서비스
 고객 서비스
LEGO.com/service

